

FLUID POWER – VOLUME 11

DEUTSCH | TÜRKÇE | POLSKI | РУССКИЙ

Freudenberg
Sealing Technologies

INHALT | İÇİNDEKILER | SPIS TREŚCI | СОДЕРЖАНИЕ

		Produkt Auswahl Ürün Bulucusu Wyszukiwarka produktu Поиск продукта	
		Metric	Imperial
Bauformliste Alphabetisch Alfabetik sıraya göre tipler Typy w porządku alfabetycznym Типы уплотнений в алфавитном порядке		4	
Hydraulikkomponenten Hidrolik Elemanlar Wyroby dla hydrauliki Компоненты гидравлической системы	Stangen- und symmetrische Dichtungen Rod ve simetrik sızdırmazlık elemanları Uszczelnienia tłoczyska oraz symetryczne Штоковые и симметричные уплотнения	17	158
	Kolben- und symmetrische Dichtungen Piston ve simetrik sızdırmazlık elemanları Uszczelnienia tłoka oraz symetryczne Поршневые и симметричные уплотнения	192	286
Abstreifer Toz keçeleri Zgarniacze Грязеъемники	Einfach wirkende Abstreifer Tek etkili sıyrıcılar Zgarniacze pojedyncze Грязеъемники одностороннего действия	320	342
	Doppelt wirkende Abstreifer Çift etkili sıyrıcılar Zgarniacze podwójnie Грязеъемники двухстороннего действия	354	378
Führungen Yataklama elemanları Prowadnice Направляющие	Kolbenführungsringe Piston yataklama elemanları Prowadnica tłoka Поршневые направляющие кольца	382	420
	Kolbenführungsband Piston yataklama bantları Prowadnica tłoka Поршневая направляющая лента	382	
	Stangenführungsringe Rod yataklama elemanları Prowadnica tłoczyska Штоковые направляющие кольца	402	420
	Stangenführungsband Rod yataklama bantları Prowadnica tłoczyska Штоковая направляющая лента	402	
Profile für oszillierende Anwendung Salımlı Uygulamalar için Profiller Profile do aplikacji oscylacyjnych Профили для колебательных движений		438	
Dichtungen für Dreh- und Schwenkbewegungen Dönme ve ileri-geri hareket için sızdırmazlık elemanları Uszczelnienia do ruchów obrotowych i wychylnych Уплотнения для вращательных и поворотных движений		440	

		Produkt Auswahl Ürün Bulucusu Wyszukiwarka produktu Поиск продукта	
		Metric	Imperial
Statische Dichtungen statik Sızdırmazlık Elemanları Uszczelnienia statyczne Статические уплотнения	Statische Dichtungen innendichtend İç çap için statik sızdırmazlık Elemanları Uszczelnienia statyczne uszczelniające od wewnątrz Статические уплотнения по внутреннему диаметру	446	
	Statische Dichtungen außendichtend Dış çap için statik sızdırmazlık Elemanları Uszczelnienia statyczne uszczelniające od zewnątrz Статические уплотнения по наружному диаметру	446	
	Statische Dichtungen axial dichtend Eksenel çalışan statik sızdırmazlık Elemanları Uszczelnienia statyczne uszczelniające osiowo Статические аксиальные уплотнения	446	
Pneumatikkomponenten PNömatik Elemanlar Wyroby dla pneumatyki Компоненты пневматической системы	Stangendichtungen Rod Sızdırmazlık Elemanları Uszczelnienia tłoka Штоковые уплотнения	454	
	Dämpfungsdichtungen Damper keçeler Tłumiki Демпферные уплотнения	458	
	Kolbendichtungen Piston Sızdırmazlık Elemanları Uszczelnienia tłoczyiska Поршневые уплотнения	462	
Stützring Destek halkası Pierścień podporowy Опорные кольца	Stützring Endlos Düz Destek halkası Pierścień podporowy Неразрезные опорные кольца	470	
	Stützring Geschlitzt Kesikli Destek halkası Dzielony pierścień podporowy Разрезные опорные кольца	470	
Montagehilfe Montaj yardım Pomoc montażowa Руководство по монтажу	Stangendichtungen Rod Sızdırmazlık Elemanları Uszczelnienia tłoka Штоковые уплотнения	188	
	Kolbendichtungen Piston Sızdırmazlık Elemanları Uszczelnienia tłoczyiska Поршневые уплотнения	317	
	Führungen Yataklama elemanları Prowadnice Направляющие	436	
O-Ring O-Ring Pierścień uszczelniający typu o-ring Кольцо круглого сечения		493	

BAUFORMLISTE ALPHABETISCH | ALFABETİK SIRAYA GÖRE TIPLER
TYPU W PORZĄDKU ALFABETYCZNYM | ТИПЫ УПЛОТНЕНИЙ В АЛФАВИТНОМ ПОРЯДКЕ

0215	193	FRA	382	NAP 310	462	SB	402
0217	193	FRI	402	NAPN	462	SBK	402
2000	420	H		NI 150	17	Seal Set 0214	19
2001	420	H	378	NI 250	17	Seal Set 0216	19
8000	420	HBTS	23	NI 300	17	SF	402
8001	420	HBY	22	NI 400	17	Simko 300	194
A		HBY	158	NIPSL	454	Simko 320 X2	195
Airzet PR	454	HDP 330	195	NIPSL 200	454	Simko 520	195
AN	342	HDR-2C	22	NIPSL 210	454	SNAP IN	342
AN SH	342	H MF	21	NIPSL 300	454	SPG	197
AS	320	H OF	21	NIPSL 310	454	SPGC	197
ASOB	320	I		NIPSL 320	454	SPGO	198
AUAS	320	IDI	24	NRS-0503	18	SPGW	198
AUASOB	320	ISI	23	O		SPN	23
AUAS R	320	IUH	23	ODI	196	SPNC	24
AU DIP	458	K		OMKE	194	SPNO	24
AU NIPSL	454	KB	382	OMKES	194	SRC	446
AUPS	320	KBK	382	OMK-MR	194	SYM	158
B		KDN	463	OMK-PU	194	SYM	286
BRN 2	470	KF	382	OMK-S	194	SYPRIM SM	19
BRN 3	470	KI 310	20	OMS-MR	19	T	
BRT 2	470	KI 320	20	OMS-MR PR	20	T 18	193
BRT 3	470	L		OMS-S	20	T 19	195
C		L 20	19	OMS-S PR	20	T 20	18
Chevron Seal Set DMS	21	L 27	195	OSI	196	T 22	18
Chevron Seal Set ES/ESV	21	L 43	195	OUHR	197	T 23	18
CPH	196	LBH	356	OUIS	197	T 24	18
CPI	196	LBI	355	P		T 42	193
D		LF 300	17	P 6	321	T 44	193
D	342	LSU	158	P 8	354	TDUOH	195
D 300	158	LSU	286	P 9	354	TDUOP	463
DIP	458	M		Packing Ring TFW	21	TDUOP AIR	463
DISO PAC	286	M 15	440	PI	286	TDUOP M	463
DKB	355	M 16	440	PK	462	TFMA	195
DKBI	355	M 17	440	Pneuko G	463	TFMI	20
DKH	321	M 19	440	Pneuko M 210	463	TM 20	18
DKI	321	MRW	342	Pneuko M 310	463	TM 21	192
DMRW	378	N		Poly Hone 1704	286	TM 23	18
D+S 300	458	N 1 / AUN 1	22	PRV 1	354	T MF	195
D-SH	343	N 1 / AUN 1	193	PT 1	354	TMP 20	19
DSI	322	N 100 / AUN 100	22	PT 2	355	TMP 21	192
DWI	322	N 100 / AUN 100	193	PU 5	321	T OF	196
DWIR	322	NA 150	192	PU 6	321	TR 200	463
E		NA 250	192	PU 11	355	U	
EK / EKV	196	NA 300	192	PU 82	446	UNI	22
EKF	382	NA 400	192	PU 83	446	V	
F		NADUOP	463	R		V 1000	20
FOA	196	NAP 210	462	RO	158	VCT	286
FOI	21	NAP 300	462	RYT	382	S	
				S		S 8	20



www.fst.com

FREUDENBERG SEALING TECHNOLOGIES

DE Freudenberg Sealing Technologies ist der größte Teilkonzern der Unternehmensgruppe Freudenberg, eines Familienunternehmens mit mehr als 37.000 Mitarbeitern in 58 Ländern. Ausgehend vom 1929 bei Freudenberg entwickelten Simmerring®, verfügt der Technologiespezialist heute über ein breites, konsequent an den Kundenanforderungen ausgerichtetes Sortiment an Dichtungen für zahlreiche Anwendungen.

Freudenberg Sealing Technologies ist führender Lieferant und Entwicklungspartner für Kunden in zahlreichen Märkten, beispielsweise in der Automobilindustrie, im Maschinenbau, in der Verfahrens- und Medizintechnik, Lebensmittel- und Pharmaindustrie, Landwirtschaft und bei Baumaschinen.

Freudenberg Sealing Technologies bietet seinen Kunden eine ständig wachsende Palette an Dichtungslösungen sowie profunde technologische Fähigkeiten. Unabhängig davon, ob eine Aufgabe eine individuell angepasste Lösung oder ein komplettes Paket von Produkten erfordert: Der Erfolg von Freudenberg Sealing Technologies beruht auf fundierten Verfahrenskennnissen, innovativen Entwicklungsmethoden und hochwertigen Materialien.

Unsere Produkte sind selten sichtbar, aber unverzichtbar. Verlassen Sie sich deshalb auf höchste Leistungsfähigkeit und Qualität der Produkte des weltweiten Marktführers in der Dichtungstechnik – auf Freudenberg Sealing Technologies.

Freudenberg Sealing Technologies verbindet ein fundiertes und anspruchsvolles technologisches Know-how mit tatkräftigem

Innovationsgeist. Materialkenntnisse, Beherrschung der Technik, Anwendungserfahrung und optimale Prozessqualität ermöglichen es Freudenberg Sealing Technologies, seinen Kunden sowohl maßgeschneiderte Lösungen als auch komplette Dichtsysteme von Weltklasse-Qualität anzubieten. Diese Lösungen werden Tag für Tag durch eine enge Zusammenarbeit und Partnerschaften mit Kunden in globalen Projekten erarbeitet.

Freudenberg Sealing Technologies ist in Europa, Nord- und Südamerika beheimatet. Gemeinsam mit den Partnern NOK Corporation, Japan, Sigma Freudenberg NOK, Indien, und NOK-Freudenberg Group China bildet das Unternehmen ein weltweites Netzwerk mit dem Ziel, den Kunden rund um den Globus Produkte in gleich hoher Qualität anzubieten.

Die Kunden nehmen Freudenberg Sealing Technologies über fünf Vertriebskanäle wahr, die als Marken in ihren Märkten seit langem etabliert und führend sind: Automotive (Automobilindustrie/Erstausrüstung), Corteco (Automobilindustrie/freier Ersatzteilmarkt), Simrit (Allgemeine Industrie), Merkel (Schwerindustrie) und Process Seals (Prozesstechnik).

TR Freudenberg Sealing Technologies, 58 ülkede 37.000'den fazla çalışanıyla Freudenberg aile şirketler grubunun içinde yer alan en büyük şirkettir. Simmerring®, 1929'dan itibaren Freudenberg tarafından sürekli geliştirilmiştir, ve şu anda sayısız uygulamalar için kullanılmaktadır ve bu teknoloji uzmanı sızdırmazlık elemanlarından oluşan geniş bir ürün yelpazesine sahiptir.

Freudenberg Sealing Technologies, otomotiv sanayii, makine imalatı endüstriyel üretim tekniği ve tıp teknolojisi, gıda ve ilaç sanayi, tarım ve inşaat makineleri gibi birçok pazarda müşterileri için lider tedarikçi ve teknoloji gelişim ortağıdır.

Freudenberg Sealing Technologies, müşterilerine sızdırmazlık elemanları çözümleri konusunda teknolojik özellikli ve devamlı genişleyen bir ürün yelpazesi sunmaktadır.

Bu, komple ürün paketi ile olduğu gibi uygulamanıza özgü çözümler ile de olabilir. Bu konuda Freudenberg Sealing Technologies'in başarısı, esaslı yöntem bilgilerine, yeni gelişim metodlarına ve kaliteli malzemelere dayanmaktadır. Her ne kadar ilk bakışta gözükmeselerde, ürünlerimiz uygulamaların vazgeçilmez yapıtaşlarından biridir. Sızdırmazlık teknolojisinde dünya çapında lider olan Freudenberg Sealing Technologies'in ürünlerinin dayanıklılığına ve kalitesine her zaman güvenebilirsiniz.

Freudenberg Sealing Technologies, esaslı ve iddialı bir teknolojik bilgi birikimi ile güçlü inovasyon ruhunu birleştirmektedir. Malzeme bilgileri, teknik hakimiyet, uygulama deneyimi ve en ideal proses kalitesi sayesinde Freudenberg Sealing Technologies hem müşteri odaklı çözümler hem de dünya kalitesinde komple sızdırmazlık sistemleri sunmaktadır.

Günlük müşterilerimizle sıkı işbirliği ve ortaklıklarıyla global projelerde çözümler üreterek. Her gün, sıkı işbirliği ve müşteri ortaklıklarıyla global projelerde çözümler geliştirilmektedir. Freudenberg Sealing Technologies, Avrupa, Kuzey ve Güney Amerika'da faaliyet gösterdiği gibi. NOK Corporation Japonya, Sigma Freudenberg NOK, Hindistan ve NOK Freudenberg Group China ortakları ile birlikte, dünya çapında bir ağ oluşturmasındaki, hedefi, müşterilerine dünya çapında ürünlerini aynı yüksek kalitede sunabilmektir.

Freudenberg Sealing Technologies müşterilerine beş satış kanalı üzerinden ulaşmaktadır. Bunlar markalar olarak kendi



pazarlarına uzun süredir yerleşmişler ve lider konumundadır: Otomotiv (Otomobil endüstrisi/ilik donatım), Corteco (Otomobil endüstrisi/serbest yedek parça pazarı), Simrit (Genel endüstri), Merkel (Ağır sanayii) ve Process Seals (Proses Tekniği).

PL Freudenberg Sealing Technologies to największa część grupy Freudenberg, przedsiębiorstwa rodzinnego zatrudniającego ponad 37.000 pracowników w 58 krajach. W roku 1929 firma Freudenberg opracowała uszczelnienie Simmerring®, dzisiaj Freudenberg Sealing Technologies jako specjalista w zakresie techniki uszczelnień dysponuje bardzo szeroką ofertą produktów stworzonych w odpowiedzi na oczekiwania klientów.

Freudenberg Sealing Technologies to wiodący dostawca uszczelnień dla różnych gałęzi przemysłu, w tym: motoryzacyjnego, maszynowego, medycznego, spożywczego, farmaceutycznego, maszyn budowlanych oraz rolniczych.

Firma Freudenberg Sealing Technologies oferuje swoim klientom stale rosnącą gamę, uszczelnień oraz specjalistyczne wsparcie. Niezależnie od tego, czy potrzebne jest indywidualne rozwiązanie, czy też niezbędny jest cały pakiet produktów, sukces firmy Freudenberg Sealing Technologies bazuje na znajomości aplikacji, innowacyjnych metodach projektowania oraz materiałach o wysokiej jakości.

Ze względu na specyfikę przestrzeni w których są montowane nasze uszczelnienia trudno jest je dostrzec, ale są one nieodzowne. Warto więc zdać się na najwyższej jakości produkty wiodącego producenta na rynku w zakresie techniki uszczelnień – na firmę Freudenberg Sealing Technologies.

Freudenberg Sealing Technologies łączy know-how z duchem innowacyjności. Znajomość materiałów, aplikacji oraz optymalna jakość procesu produkcji umożliwiają firmie Freudenberg Sealing Technologies zaoferowanie zarówno skrojonych na miarę rozwiązań jak również światowej klasy kompletnych systemów uszczelniających. Dzień po dniu rozwiązania te są opracowywane w ramach globalnych projektów w ścisłej współpracy i partnerskim współdziałaniu z klientami.

Freudenberg Sealing Technologies działa w Europie, Ameryce Północnej oraz Południowej. Wspólnie z partnerami z NOK Corporation z Japonii, Sigma Freudenberg NOK z Indii i NOK-Freudenberg Group z Chin przedsiębiorstwo tworzy światową sieć, której celem jest oferowanie klientom na całym świecie produktów o najwyższej jakości.

Freudenberg Sealing Technologies posiada pięć kanałów dystrybucyjnych, które od dawna zadomowiły się jako wiodące marki: Automotive (przemysł motoryzacyjny/pierwszy montaż), Corteco (przemysł motoryzacyjny/rynek części zamiennych), Simrit (przemysł ogólny), Merkel (przemysł ciężki) i Process Seals (technika procesowa).

RU «Фройденберг Силинг Технолоджис» - это крупнейший концерн «Группы Фройденберг», который и по сей день является семейным предприятием, представленным в 58 странах мира, штат которого насчитывает более 37.000 сотрудников. Начав с радиального уплотнения вала Simmering®, разработанного в 1929 году, компания «Фройденберг» располагает сегодня, пожалуй, самым широким ассортиментом уплотнений, оптимально адаптированным к индивидуальным потребностям заказчиков.

Фирма «Фройденберг Силинг Технолоджис» - ведущий поставщик и партнер по разработкам для заказчиков, работающих в различных отраслях, таких как автомобильная промышленность, сельскохозяйственное и дорожно-строительное машиностроение, оборудование для пищевой и фармацевтической промышленности, станкостроение, производственное и медицинское оборудование.

«Фройденберг Силинг Технолоджис» предлагает своим заказчикам постоянно растущий ассортимент решений в области уплотнений и фундаментальные технологические знания. Вне зависимости от того, требуется ли для выполнения поставленной задачи одно индивидуальное решение или комплексный пакет продуктов: успех «Фройденберг Силинг Технолоджис» основывается на глубоких технологических знаниях, инновационных методах разработок и применении высококачественных материалов.

Наши продукты незаметны, но без них не обойтись. Поэтому положитесь на высочайшую эффективность и качество продукции мирового лидера в сфере уплотнений - «Фройденберг Силинг Технолоджис».

Компания «Фройденберг Силинг Технолоджис» объединяет в себе солидное технологическое ноу-хау и активное стремление к инновациям. Знание материалов, владение техникой, практический опыт и оптимальное качество процессов позволяют «Фройденберг Силинг Технолоджис» предлагать заказчикам индивидуальные решения и комплексные уплотнительные системы высшего

качества. Изо дня в день мы создаем решения в тесном сотрудничестве и партнерстве с нашими заказчиками в рамках глобальных проектов.

Компания «Фройденберг Силинг Технолоджис» располагается в Европе, Северной и Южной Америке. Совместно со своими партнерами «НОК Корпорейшн», Япония, «Сигма Фройденберг НОК», Индия, и «НОК -Фройденберг Групп», Китай, предприятие располагает сетью производств, задачей которой является обеспечение заказчиков по всему миру продуктами одинаково высокого качества.

Продукция «Фройденберг Силинг Технолоджис» известна заказчикам по пяти каналам сбыта, марки которых уже давно занимают лидирующие позиции на рынке: «Automotive» (автомобильная промышленность/комплектация новых автомобилей), «Corteco» (автомобильная промышленность/рынок запасных частей), «Simrit» (общая промышленность), «Merkel» (тяжелая промышленность) и «Process Seals» (перерабатывающие отрасли).



DE DIE MISCHUNG MACHT DEN UNTERSCHIED

NBR, FKM, HNBR, EPDM, PTFE ... Die Liste der Dichtungswerkstoffe ist lang und das Wissen um die passende Materialmischung für Ihre Anwendung ist oft eine Wissenschaft. Denn: Das richtige Material bildet die Basis innovativer Lösungen. Zur einzigartigen Vielfalt an Standardwerkstoffen kommt bei Freudenberg Sealing Technologies das Know-how, ein Dichtungsmaterial für jedes spezielle Kundenbedürfnis entwickeln und optimal auslegen zu können.

Dies erfordert langjährige Werkstoff Erfahrung. Und es erfordert ausgeklügelte Materialmodelle, Berechnungs-, Test- und Simulationsmethoden sowie Hightech-Prüfstände für praxisnahe Bauteilanalysen. Wir greifen hierzu auf die Forschungs- und Entwicklungseinrichtungen der gesamten Freudenberg Gruppe zurück. Hinzu kommen Entwicklungsprojekte und Kooperationen mit Hochschulen, Forschungsinstituten sowie führenden Polymer- und Chemikalienherstellern.

Aus unserem Gewusst-wie resultiert Ihr technischer Vorsprung, der sich unter anderem in kurzen Entwicklungszeiten und erstklassiger Qualität vom ersten Teil an dokumentiert. Ein wesentlicher Erfolgsfaktor dabei: Wir stellen unsere Materialmischungen selbst im eigenen Haus her – Qualität von Anfang an!

TR KARIŞIM FARK YARATIR

NBR, FKM, HNBR, EPDM, PTFE ... sızdırmazlık elemanlarında kullanılan malzemeler oldukça uzundur ve sizin uygulamanız için kullanılacak malzeme çok özel bir karışım olabilir. Doğru karışımı oluşturmak uzmanlık isteyen bir bilim dalıdır. Çünkü: doğru malzeme, yenilikçi çözümlerin temelini oluşturur. Standart malzemelerin olağanüstü zenginliği Freudenberg Sealing Technologies'te teknik bilgi ile her müşteri ihtiyacına uyum sızdırmazlık elemanı malzemesi geliştirebilmek ve en ideal biçimde tasarlayabilmekle mümkündür.

Bu uzun sürelere dayanan malzeme bilgisi ve deneyimi gerektirdiği gibi, teferuatlı malzeme modelleri, hesaplama, test ve simülasyon metodları ve de parçanın gerçekte kullanıldığı ortamdaki çevre koşullarını oluşturan ve analiz edebilen ileri teknoloji test imkanına ihtiyaç duyar. Biz bunun için komple Freudenberg Grubu'nun araştırma ve geliştirme birimlerinden faydalanmaktayız. Buna bir de üniversite ve araştırma enstitüleri ile işbirlikleri ve geliştirme projeleri ve lider polimer ve kimya üreticileri eklenmektedir.

Tecrübelerimizden- ilk parçadan itibaren kısa süreli geliştirme zamanı ve birinci sınıf kaliteyi belgeleyen teknik açıdan önderliğiniz. Bu konudaki en önemli başarı faktörlerimizden biri de kendi malzeme karışımımızı kendimiz yine kendi tesislerimizde ürettiyor olmamızdır böylelikle kaliteyi daha başlangıçta garanti altına alıyoruz!

PL MIESZANKA ROBI RÓŻNICĘ

NBR, FKM, HNBR, EPDM, PTFE ... Lista tworzyw, z których są wykonywane uszczelnienia jest długa, a wiedza konieczna do uzyskania odpowiedniej mieszanki do danego zastosowania, to dziedzina nauki. Właściwy materiał stanowi podstawę innowacyjnych rozwiązań. Obok wyjątkowo bogatej oferty materiałów standardowych firma Freudenberg Sealing Technologies posiada know-how pozwalający na opracowanie i wyprodukowanie optymalnej mieszanki dla danej aplikacji.

Wymaga to wieloletniego doświadczenia w dziedzinie tworzyw. Niezbędne są także zaawansowane modele materiałów, metody obliczeniowe, testowe oraz symulacje, a także nowoczesne stanowiska badawcze służące do analiz komponentów w warunkach zbliżonych do rzeczywistych. W tym celu wykorzystujemy urządzenia badawcze i projektowe całej grupy Freudenberg. Do tego dochodzą projekty rozwojowe oraz współpraca ze szkołami wyższymi, instytucjami badawczymi oraz wiodącymi producentami polimerów i chemikaliów.

Nasz know how przekłada się na postęp technologiczny naszych klientów, dodatkowo umożliwia realizację projektów w krótkim czasie oraz zapewnia pierwszorzędnej jakości produkty. Istotnym czynnikiem sukcesu jest fakt, że mieszanki produkujemy w naszej własnej fabryce – jakość od samego początku!

RU РАЗНИЦА В МАТЕРИАЛЕ

NBR, FCR, HNBR, EPDM, PTFE ... Перечень уплотнительных материалов очень длинный, а определение правильной смеси материала, подходящей для конкретного случая применения представляет собой, зачастую, целую науку.

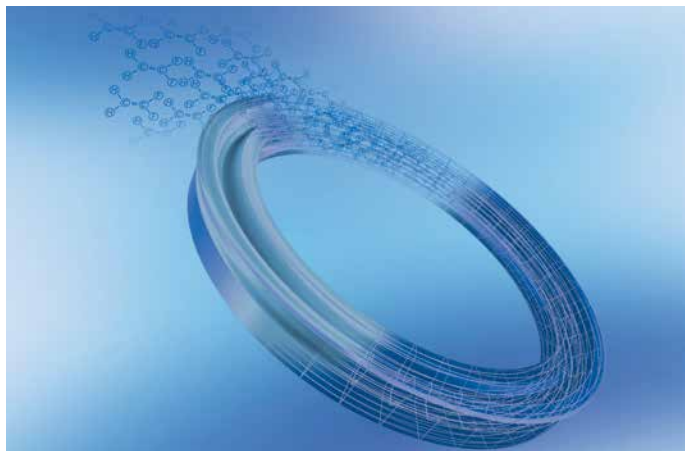

Правильный материал – это основа инновационных решений. Помимо уникального разнообразия стандартных материалов «Фройденберг Силинг Технолоджис» обладает необходимыми знаниями и навыками, которые позволяют разработать уплотнительный материал, отвечающий индивидуальным потребностям заказчика, и создать из него оптимальное уплотнение.

Выполнение подобной задачи требует многолетнего опыта работы с материалами. Создаются модели материалов, используются сложные методологии расчетов, испытаний и моделирования, применяются высокотехнологичные стенды, позволяющие проводить испытания в условиях, максимально приближенным к реальным. В ходе исследований и разработок мы используем весь потенциал «Группы Фройденберг». Кроме этого, мы реализуем проекты в сотрудничестве с ВУЗами, научно-исследовательскими институтами, производителями полимеров и химикатов.

Наши знания и опыт дают Вам техническое преимущество, обеспечиваемое, в частности, короткими сроками разработок и высоким качеством продукции, начиная с первого экземпляра. Залог нашего успеха – это материалы, которые мы производим сами, а значит, гарантируем качество с самого начала!

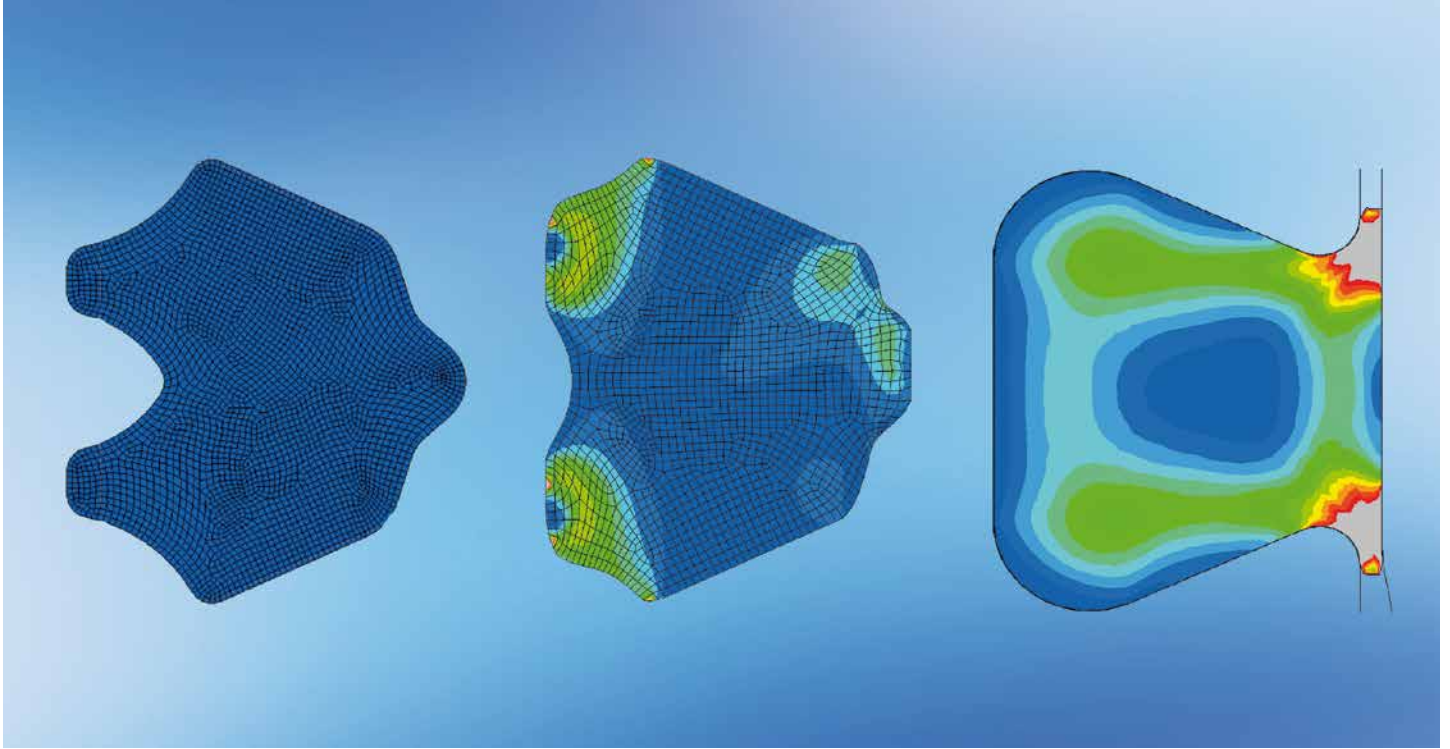

DE DESIGN: FUNKTIONAL IST OPTIMAL

Dichtheit bei Minimierung von Reibung und Verschleiß. So einfach diese Formel klingt, so komplex gestaltet sich ihre Umsetzung im konkreten Einzelfall. Dichtungs-Werkstoff und -Design müssen die passende Symbiose für die von Ihnen angefragte, ganz spezielle Anwendung eingehen.

Numerische Simulationsverfahren wie die Finite Elemente Methode (FEM) spielen dabei eine zentrale Rolle. Sie ermöglichen, unterschiedliche Geometrien zu untersuchen, verschiedene Werkstoffe zu testen und das Bauteilverhalten unter wechselnden Belastungen zu überprüfen – ohne jedes Mal aufwändige Prototypen herzustellen! Dies beschleunigt den Entwicklungsprozess, gestaltet ihn kostengünstiger und erhöht letztlich die Produktqualität. Vorausgesetzt man verfügt – wie Freudenberg Sealing Technologies – über Spezialisten, die in der Lage sind, Ergebnisse richtig zu interpretieren und in sinnvolle Lösungen umzusetzen.

Die besondere Herausforderung lautet: Elastomerwerkstoffe verhalten sich nichtlinear. Dies erfordert komplexe Simulationsmodelle. Mit Hilfe des eigens entwickelten Freudenberg-Werkstoffmodells gelingt es, das Dichtungsverhalten korrekt vorherzusagen, also Werkstoff und Design optimal auf Ihre Anforderungen auszugestalten.

TR TASARIM: EN İYİSİ İŞLEVSELLİKTİR

Sızdırmazlık elemanlarında sürtünme ve aşınmayı minimize etmek sızdırmazlığı sağlar formülü kulağa ne kadar basit gelse de özel durumda bunların hayata geçirilmesi bir o kadar karmaşık olduğu görülmüştür. Talep ettiğiniz özel uygulamalarınızda; sızdırmazlık elemanı için gerekli malzeme ve sızdırmazlık elemanın tasarımı birbirinden ayrılmaz bir ikilidir.

Sonlu Elemanlar Metodu (FEM) gibi nümerik simülasyon yöntemleri bu anlamda önemli bir rol oynamaktadır. Bu teknikler; farklı geometrileri araştırma, çeşitli malzemeleri test etme ve değişen yükler altında parça davranışını inceleme imkanı sunar hem de her seferinde masraflı prototipler hazırlamaya gerek kalmadan! Bu, geliştirme sürecini hızlandırmakta, en hesaplı ve daha yüksek kalitede ürün kalitesi sağlamaktadır. Freudenberg Sealing Technologies gibi sonuçları doğru yorumlayarak faydalı çözümlere dönüşürecek uzmanlarınızın olması gerekmektedir.

Elastomer malzemeler doğrusal olmayan yapısı nedeniyle zorluk göstermektedir. Bu da karmaşık simülasyon modelleri gerektirmektedir. Freudenberg'in kendi içinde geliştirdiği özel malzeme modellemesi sayesinde sızdırmazlık elemanının davranış karakteri kusursuz olarak önceden bilinir. Diğer bir deyişle; Freudenberg'de sizin uygulamanız için ihtiyaç duyduğunuz tasarım ve malzeme optimum şekilde size özel yapılandırılır.

PL BUDOWA: FUNKcjONALNOŚĆ I OPTYMALIZACJA

Redukując tarcie oraz zużycie wydłuża się żywotność uszczelnienia. Jakkolwiek reguła ta brzmi prosto to w konkretnych przypadkach realizacja jej jest niezmiernie skomplikowanym zadaniem. W danej aplikacji pomiędzy geometrią uszczelnienia, a materiałem z którego jest ono wykonane, musi być symbioza.

Korzystanie z symulacji numerycznych w tym metody elementów skończonych (FEM) odgrywa tutaj kluczową rolę. Umożliwia to przetestowanie różnych geometrii oraz materiałów, a także badanie zachowania się uszczelnień poddanych zmieniającym się obciążeniom – bez potrzeby sporządzenia za każdym razem kosztownego prototypu! Przyspiesza to proces rozwoju, obniża jego koszty i decyduje o wysokiej jakości produktu. Warunkiem jest posiadanie – jak Freudenberg Sealing Technologies – specjalistów, którzy potrafią właściwie zinterpretować wyniki symulacji i przełożyć je na praktyczne rozwiązania.

Szczególnym wyzwaniem jest fakt, że tworzywa elastomeryczne nie zachowują się w sposób linearny. Wymaga to zastosowania złożonych modeli symulacyjnych. Za pomocą stworzonego przez siebie modelu tworzyw jesteśmy w stanie poprawnie przewidzieć zachowanie się uszczelnień, czyli optymalnie dopasować tworzywo i geometrię uszczelnień do ich konkretnych zastosowań.

RU КОНСТРУКЦИЯ: ПОИСК ОПТИМАЛЬНОГО РЕШЕНИЯ

Герметичность при минимизации трения и износа. Насколько простой выглядит данная задача, настолько же сложной является ее реализация в каждом конкретном случае.



Материал и конструкция уплотнения должны образовывать симбиоз, полностью отвечающий Вашим индивидуальным потребностям.

Главную роль в процессе разработки уплотнения играют численные методы моделирования, такие как метод конечных элементов (FEM). Они позволяют исследовать различные формы, испытывать разнообразные материалы и проверять поведение компонентов под воздействием возможных нагрузок без необходимости создавать каждый раз дорогие прототипы! Это ускоряет процесс разработки, сокращает затраты и в итоге повышает качество продукции. Обязательной предпосылкой при этом является наличие высококвалифицированного специалиста, как «Фройденберг Силинг Технолоджис», который способен правильно интерпретировать результаты испытаний и превратить их в эффективные решения.

Дополнительная сложность в процессе разработки уплотнений – это нелинейное поведение эластомерных материалов, требующее создания сложных моделей. Модели материалов, разработанные компанией «Фройденберг», позволяют точно определить характеристики уплотнительных компонентов, их поведение в системе, и, тем самым, оптимально адаптировать материал и конструкцию под Ваши индивидуальные требования.

FREUDENBERG XPRESS

DE FREUDENBERG XPRESS: BESTELLT. GEDREHT. DELIEFERT.

Freudenberg Xpress – das ist Originalqualität für den schnellen Reparaturbedarf, für wirtschaftliche Kleinserien und verlässliches Prototyping. Von Ihnen bestellt, von uns umgehend aus einer breiten Palette von Originalwerkstoffen auf modernen CNC-Maschinen gedreht: auf Wunsch maßgeschneidert nach Ihrer Zeichnung oder Ihrem Muster. Kurzfristig geliefert: bei Standard-Dichtungen innerhalb von 24 Stunden, wenn es ganz schnell gehen muss, sogar eher.

So minimiert Freudenberg Xpress Ihre Maschinenstillstandzeiten sowie Ihre Produktionskosten und maximiert Ihre Flexibilität. Denn: Was Sie jederzeit bestellen können und kurzfristig geliefert bekommen, müssen Sie nicht vorrätig haben. Das ermöglicht Ihnen eine schlanke Lagerhaltung.

Freudenberg Xpress Service:

- Abstreifer, Stangen- und Kolbendichtungen, Führungen, O-Ringe und Simmerringe
- aus Elastomeren, Polyurethan, und PTFE
- von zehn Millimetern bis vier Metern Durchmesser
- mit Zugriff auf die Freudenberg-Profildatenbank mit zirka 300 Bauformen
- mit den identischen Freigaben der Original-Serienteile
- in Qualität und Güte des Serienprodukts
- wirtschaftlich ab einem Stück
- zertifiziert nach ISO 9001.

TR FREUDENBERG XPRESS: SIPARIŞ, CNC İŞLEME VE TESLİMAT.

Freudenberg Xpress – hızlı tamirat ve ya bakım onarım ihtiyacınızda ve güvenilir prototip üretimleriniz için ekonomik küçük lotlarda ve orijinal kalitede sızdırmazlık elemanları sunar. Siz siparişinizi çeker çekmez, talep edilen parça teknik resmine uygun olarak geniş orijinal malzeme seçeneğiyle CNC makinelerinde üretilir. En Kısa sürede teslim edilir: Standart keçeler 24 saat içerisinde, eğer acil olursa daha da erken. Bu sayede Freudenberg Xpress, ihtiyaç duyduğunuz parça sebebiyle üretiminizin durma sürelerini ve dolayısıyla üretim maliyetlerini en aza indirerek, size bu konuda esneklik kazandırır. Herşeyin ötesinde ihtiyaç duyulan parçayı stok tutmak durumunda olmayacaksınız çünkü ihtiyaç duyduğunuzda parça size en kısa sürede üretilip teslim edilecek, bu da size stok maliyetlerinizi azaltmanıza imkan tanıyacak.

Freudenberg Xpress Service:

- toz keçeleri, rod ve piston keçeleri, yataklama elemanları, O-Ringler ve yağ keçelerini kapsamaktadır.
- elastomer, poliüretandan ve PTFE'den imalat.
- Ø 10 mm – Ø 4 metre çap aralığı.
- yaklaşık 300 değişik tasarımlı Freudenberg Profil Veri Bankasına erişim ile
- orijinal seri parçalarının özdeş onayları ile.
- Seri üretim kalitesinde.
- Parça adeti arttıkça daha ekonomik fiyat seçeneği
- ISO 9001'e göre sertifikalı

PL FREUDENBERG XPRESS: ZAMÓWIONE. WYKONANE. DOSTARCZONE.

Freudenberg Xpress to oryginalna jakość nieodzowna przy wykonywaniu szybkich napraw. Technologia ta ma zastosowanie zarówno to produkcji małych, ekonomicznych serii, jak i do sporządzania niezawodnych prototypów. Niezwłocznie po złożeniu zamówienia, na nowoczesnych maszynach CNC, wykonujemy produkt – zgodnie z dostarczonym rysunkiem lub wzorem. Do dyspozycji pozostaje szeroka gama oryginalnych tworzyw. Krótkie terminy dostaw: w przypadku uszczelnień standardowych w ciągu 24 godzin, a jeśli sprawa jest pilna, nawet szybciej.

W ten sposób Freudenberg Xpress minimalizuje czasy przestoju, koszty produkcji oraz maksymalizuje elastyczność klientów. Dzięki możliwości składania zamówień w dowolnym momencie oraz krótkim czasem dostawy nie ma potrzeby składowania części na magazynie. Umożliwia to zmniejszenie stanu magazynowego.

Freudenberg Xpress oferuje:

- zgarniacze, uszczelnienia tłoków i tłoczysk, prowadnice, o-ringi oraz simmerringi
- z elastomerów, poliuretanu i PTFE
- od dziesięciu milimetrów do czterech metrów średnicy
- z dostępem do bazy danych profiliów Freudenberg zawierającej około 300 konstrukcji
- z identycznymi certyfikatami jak oryginalne części produkowane seryjnie
- o jakości i cechach produktu seryjnego
- ekonomicznie od jednej sztuki
- ISO 9001.

RU FREUDENBERG XPRESS: ЗАКАЗАНО. ИЗГОТОВЛЕНО. ПОСТАВЛЕНО.

Freudenberg Xpress – это оригинальное качество для аварийного ремонта, экономичное мелкосерийное производство и надежное изготовление прототипов. Получив Ваш заказ, мы немедленно изготавливаем деталь из широкого ассортимента оригинальных материалов на современном оборудовании с ЧПУ: по Вашему желанию, чертежу или образцу. Быстрая поставка: при заказе стандартных уплотнений - в течение 24 часов, а, если необходимо, то даже быстрее.

Freudenberg Xpress минимизирует время простоя Вашего оборудования, снижает Ваши производственные расходы и оптимизирует гибкость производства. Ведь то, что Вы можете в любое время заказать и быстро получить, Вам

не нужно держать на складе. Наши услуги позволяют Вам сокращать складские мощности.

Услуги Freudenberg Xpress:

- грязесъемники, штоковые и поршневые уплотнения, направляющие, кольца круглого сечения и радиальные уплотнения вала Simmerring;
- уплотнения из эластомеров, полиуретана и ПТФЭ;
- диаметр уплотнений от десяти миллиметров до четырех метров;
- доступ в базу данных формованных уплотнений ф. Фройденберг, содержащую около 300 конструкций;
- оценка качества аналогична оригинальным серийным продуктам;
- качество соответствует серийным продуктам;
- экономичное производство от одной штуки и более;
- сертификат ISO 9001.

MATERIAL EXPERTISE: OVERVIEW OF FREUDENBERG XPRESS MATERIALS

Polyurethanes (PU)	Material	Color
■ 94 AU 925	Original Freudenberg material	blue
■ 92 AU 21100	Original Freudenberg material, low temperature	colorless
■ 94 AU 21730	Original Freudenberg material, FDA compliant, hydrolysis resistant	blue
■ 95 AU 21420	Original Freudenberg material, FDA compliant, hydrolysis resistant	red
■ 93 AU V167	Original Freudenberg material, FDA compliant, hydrolysis resistant	red
■ 95 AU V142	Original Freudenberg material	blue
Elastomers (75-95 Shore A)		
■ 72 NBR 902	Original Freudenberg material	blue
■ 75 FKM 585	Original Freudenberg material	brown
■ 70 EPDM 291	Original Freudenberg material, FDA compliant	black
■ 85 EPDM 292	Original Freudenberg material, FDA/KTVW compliant	black
■ 70 NBR 150	Original Freudenberg material, FDA compliant	black
■ 88 NBR 156	Original Freudenberg material, FDA compliant	black
■ 75 Fluoroprene XP 40	Original Freudenberg material, FDA compliant	blue
■ 85 NBR	Standard Freudenberg Xpress material	black
■ 85 FKM	Standard Freudenberg Xpress material	brown
■ 85 EPDM	Standard Freudenberg Xpress material	black
■ 85 HNBR	Standard Freudenberg Xpress material	green
Polytetrafluorethylen (PTFE)		
■ W FLON	Virginal PTFE	white
■ G FLON	Filler: 15% Glass, 5% MoS ₂	anthracite
■ B FLON	Filler: 40% Bronze, 2% Carbon	bronze
■ C FLON	Filler: 25% Carbon	black
■ EF FLON	Filler: 10% Econol, aromatic Polyester, FDA compliant	beige
Laminated Fabric		
■ HG 517	Original Freudenberg material	anthracite

■ = Original Freudenberg design and material

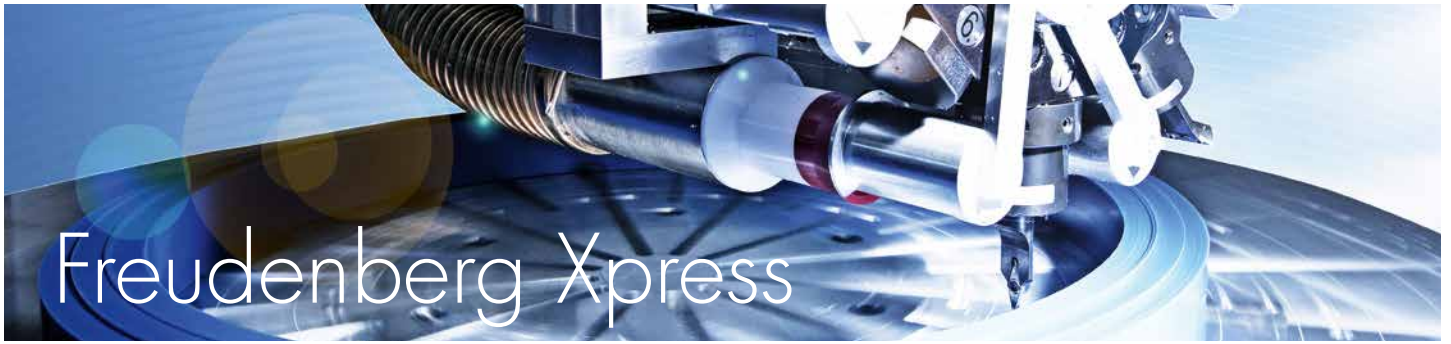

PISTON SEALS (DK)

DK 101 (NA300)	DK 102	DK 102R (NA250/NA400)	DK 103	DK 104	DK 104R	DK 105
DK 205 (TMP21)	DK 106 (AUN100)	DK 107	DK 108 (OMK-MR)	DK 109	DK 109D	DK 109H
DK 109N	DK 110-112	DK 216 (T)	DK 117 (L43)	DK 118	DK 119 (FOA)	DK 120
DK 122	DK 222 (L27)	DK 123	DK 123D	DK 123H	DK 123N (T42)	DK 124
DK 125 (OMKE)	DK 126	DK 127	DK 138 (OMK-S)	DK 238 (OMKES)	DK 139	DK 140 (OMK-PL)
DK 141	DK 142	DK 199	SIMKO 300			

ROD SEALS (DS)

DS 101 (T20)	DS 102	DS 102R	DS 103 (Ni250/Ni400)	DS 104	DS 104R	DS 105
DS 205 (TMP20)	DS 106 (AUN100)	DS 107	DS 108 (K1310)	DS 109	DS 110-112 (ES)	DS 216 (H)
DS 117 (Ni300)	DS 117R (T23)	DS 119 (FOI)	DS 120	DS 121	DS 124 (OMSMRDW)	DS 125
DS 126-128 (FTW)	DS 129 (OMSMR)	DS 130	DS 131	DS 138	DS 238 (OMS-S)	DS 139
DS 141	LF 300					

WIPERS (DA)

DA 101 (ASOB)	DA 102 (AUASOB)	DA 103 (AS)	DA 107	DA 108	DA 109	DA 211 (P9/PU11)
DA 212 (P8)	DA 113	DA 213	DA 114	DA 115	DA 116	DA 117 (PT1)
DA 118						

ROTARY SEALS (DR)

DR 103	DR 104	DR 105	DR 110	DR 111	DR 112	DR 113
DR 115 (M15)	DR 116 (M16)	DR 117 (9489)	DR 118	DR 119		

GUIDES (DF)

DF 101 (SB/KB)	DF 102 (EKF)	DF 103	DF 104	DF 105	DF 106	DF 107
DF 108						

BACK RINGS (DST)

DST 108	DST 109	DST 110	DST 111	DST 112	DST 113	DST 114 (SPR)

FLAT GASKETS (DFL)

DFL 101	DFL 102	DFL 106 (O-Ring)	DFL 108	DFL 109	DFL 110

= Original Freudenberg design and material

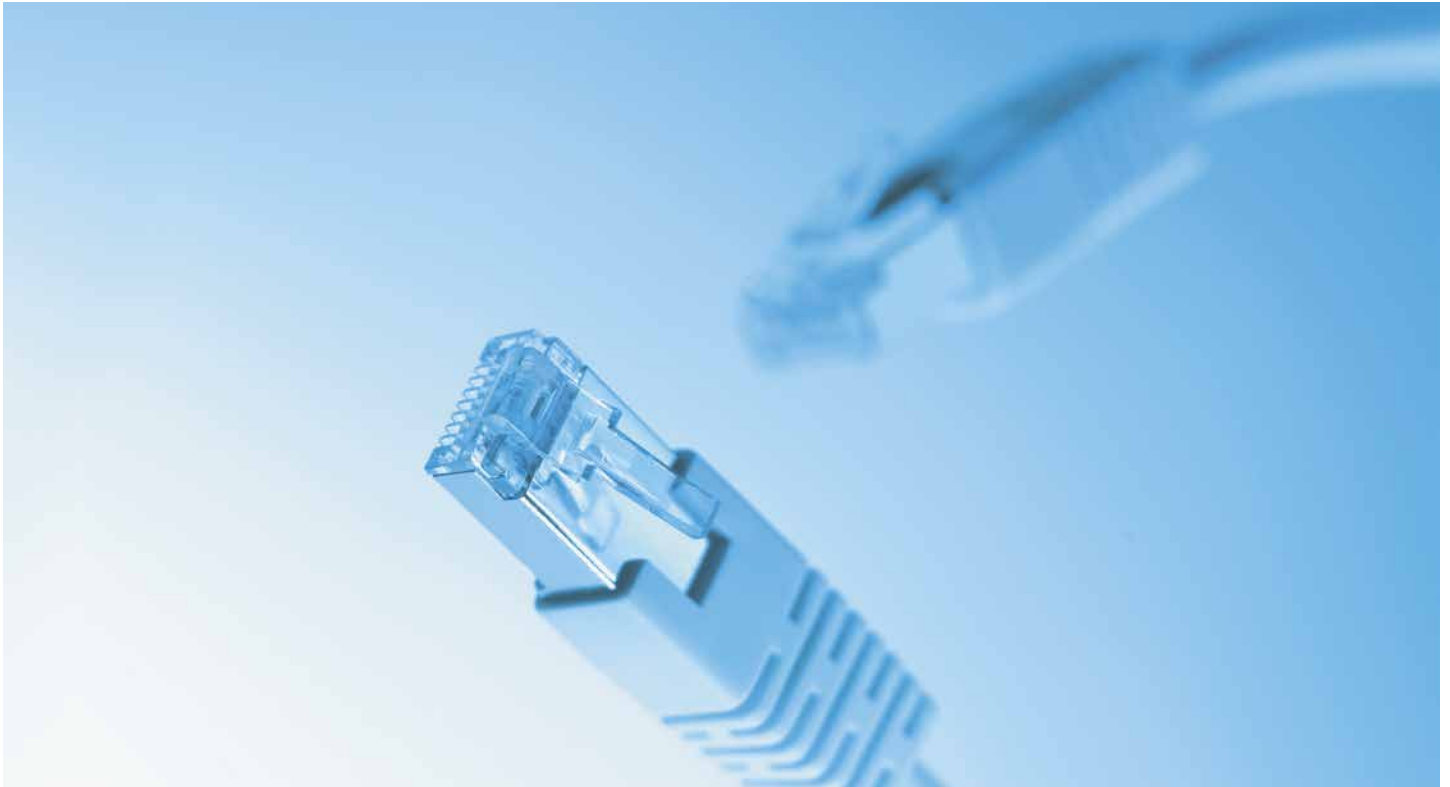

FREUDENBERG SEALING TECHNOLOGIES ONLINE

DE SUCHEN WAR GESTERN

Online kommen Sie bei Freudenberg Sealing Technologies besonders schnell und zielgenau zur richtigen Dichtung. Mit wenigen Mausklicks leitet Sie die benutzerfreundliche Navigation sicher ans Ziel: Finden, vergleichen, auswählen und merken (direkt online bestellen)!

Bei Entwicklern und Konstrukteuren besonders gefragt ist das Herunterladen von zwei- und dreidimensionalen CAD-Zeichnungen. Diese liegen in sämtlichen gängigen Formaten vor. Die Zeichnungen können Sie direkt in Ihre Konstruktionsprogramme einbinden. Das vereinfacht Ihre Produktentwicklung, beschleunigt Ihre Entwicklungszeiten und senkt Ihre Konstruktionskosten.

Die Vorteile des Online-Services von Freudenberg Sealing Technologies auf einen Blick:

- Im eCatalog finden Sie alle Produkt- und Werkstoffdatenblätter auf aktuellem Stand.
- Komfortable Suchwerkzeuge gestalten das schnelle, ziel-sichere Finden des richtigen Artikels sowie Ihre Bestellung zum Kinderspiel.
- Von mehreren Zehntausend Komponenten der Dichtungstechnik stehen Ihnen Bauformskizzen sowie CAD-Geometrien online zum Download zur Verfügung.

TR ARAMAK DÜNDE KALDI.

Çevrimiçi olarak Freudenberg Sealing Technologies' e erişim yaparak aradığınız doğru sızdırmazlık elemanına özellikle hızlı ve hedef odaklı ulaşabilirsiniz. Birkaç tıklamayla sizi, kullanımı kolay navigasyon sizi doğru şekilde aradığınız hedefe ulaştırmaktadır. Aramak, karşılaştırmak, seçmek ve akılda tutmak doğrudan çevrimiçi sipariş etmek!

Tasarım mühendisleri ve ürün geliştirmeciler tarafından özellikle de iki ve üç boyutlu CAD çizimlerine erişim imkanı! Bunlar tüm geçerli dosya formatlarda hazır bulunmaktadır. Çizimleri doğrudan konstrüksiyon programlarınıza bağlayabilirsiniz. Bu sizin ürün geliştirmenizi kolaylaştırır, geliştirme sürelerinizi hızlandırır ve konstrüksiyon maliyetlerinizi azaltır.

Bir bakışta Freudenberg Sealing Technologies'in çevrimiçi servislerinin avantajları:

- e-katalog içerisinde tüm ürün ve malzeme bilgi föylerini güncel sürümleriyle bulabilirsiniz.
- Basit ve uygun arama araçları ile, doğru ürünün hızlı, hedef odaklı bulunmasına imkan verir.
- Sızdırmazlık teknolojilerindeki on binlerce sızdırmazlık elemanlarına ait CAD tasarımlar ve diyagramları yükleme imkanı.

PL WYSZUKIWANIE ONLINE

Firma Freudenberg Sealing Technologies oferuje bardzo szybkie wyszukiwanie uszczelnień online. Kilka kliknięć myszką w łatwej do obsługi nawigacji prowadzi prosto do celu: można porównać, wybrać i odhaczyć!

Projektanci i konstruktorzy często korzystają z możliwości pobrania dwu- lub trójwymiarowych rysunków CAD. Dostępne są one we wszystkich popularnych formatach. Rysunki te można wykorzystać we własnych programach do projektowania. Upraszcza to procesy projektowania, przyspiesza ich tworzenie i obniża ich koszty.

Zalety systemu online firmy Freudenberg Sealing Technologies:

- W e-Catalogu można znaleźć aktualną bazę naszych produktów oraz ich karty charakterystyki
- Komfortowe narzędzia do wyszukiwania zapewniają szybkie znalezienie właściwego artykułu.
- Dla kilkudziesięciu tysięcy wyrobów z zakresu techniki uszczelnień dostępne są, do pobrania online, diagramy oraz geometrie – CAD

RU ПОИСК ОСТАЛСЯ В ПРОШЛОМ

Интернет позволяет быстро и целенаправленно находить требуемые Вам уплотнения «Фройденберг Силинг Технолоджис». Несколько щелчков мышки - и удобная навигация нашего сайта приводит Вас прямо к цели: Вы находите, сравниваете, выбираете и помечаете требуемый Вам продукт!

Разработчикам и конструкторам мы предлагаем для загрузки двух- или трехмерные чертежи CAD. Данные чертежи предлагаются во всех распространенных форматах. Вы можете напрямую использовать данные чертежи в своих конструкторских программах. Это облегчает Вам разработку продукта, сокращает временные затраты и расходы на проектирование.

Интернет-портал «Фройденберг Силинг Технолоджис» предлагает Вам следующие преимущества:

- В электронном каталоге представлены технические спецификации всех продуктов и материалов в последней редакции.
- Удобные инструменты поиска позволяют Вам быстро и целенаправленно находить требуемые Вам продукты.

- Для загрузки предлагаются изображения и чертежи CAD нескольких десятков тысяч уплотнительных компонентов.

Type	LF 300			NI 150	NI 250	NI 300		NI 400
Standard	ISO			ISO	ISO	ISO		ISO
Shape								
Compound	Polyurethane 94 AU 925	Polyurethane 92 AU 21100	Polyurethane 94 AU 30000	NBR 80 NBR 878	NBR / POM 80 NBR 878 PO 992020	Polyurethane 94 AU 925	Polyurethane 94 AU 30000	NBR / POM 80 NBR 878 PO992020
								
								
								
Applications								

Bitte beachten Sie unsere allgemeinen Konstruktionshinweise in → Technisches Handbuch

Daha detaylı montaj bilgisi için → Bkz. Technical Manual

W celu zaznajomienia się z ogólnymi uwagami proszę skorzystać z Instrukcji

Общие технические рекомендации см. → Техническое руководство













Type	T 20		T 22	T 23	T 24	TM 20	TM 23	NRS-0503
Standard	ISO		ISO	ISO	ISO	ISO	ISO	ISO
Shape								
Compound	Polyurethane 94 AU V142	Polyurethane 94 AU 30000	Polyurethane 95 AU V142	Polyurethane/POM 95 AU V142 PO202	Polyurethane 95 AU V142	Polyurethane 95 AU V142	Polyurethane 95 AU V157 93 AU V167	Polyurethane 95 AU V142
Applications								

Bitte beachten Sie unsere allgemeinen Konstruktionshinweise in → Technisches Handbuch
 Daha detaylı montaj bilgisi için → Bkz. Technical Manual
 W celu zaznajomienia się z ogólnymi uwagami proszę skorzystać z Instrukcji
 Общие технические рекомендации см. → Техническое руководство

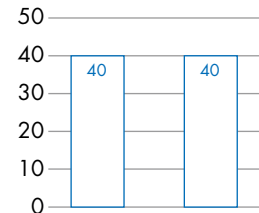
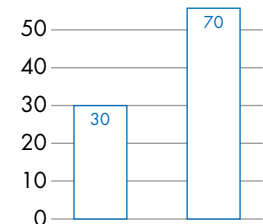
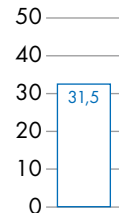
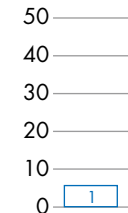
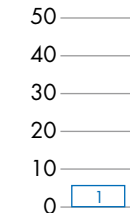
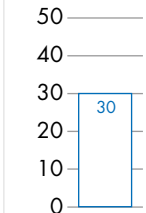
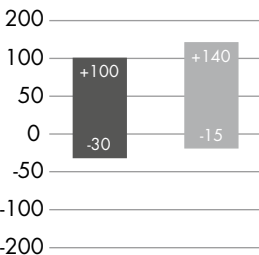
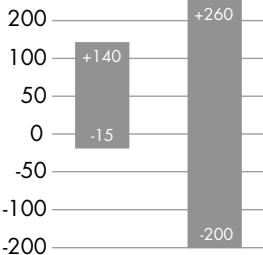
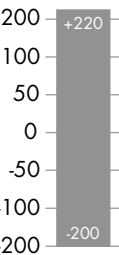
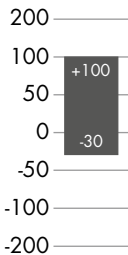
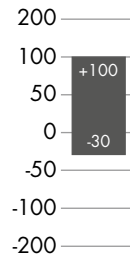
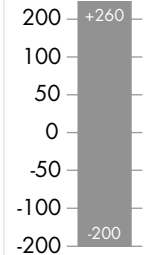
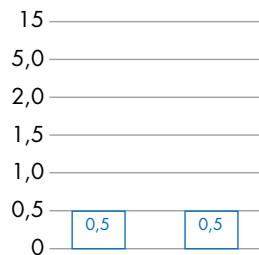
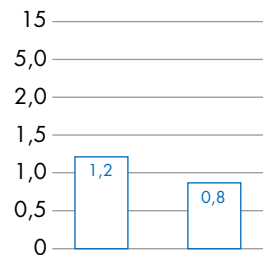
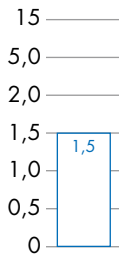
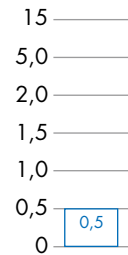
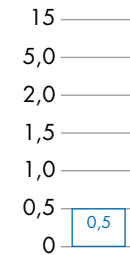
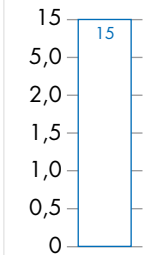
L 20		SYPRIM SM		Seal Set 0214	Seal Set 0216	TMP 20	OMS-MR	
ISO		ISO		ISO	ISO	ISO	ISO	
NBR 85 NBR B203 85 NBR B247	FKM 85 FKM K664	Polyurethane/POM 95 AU V142 PO202	Polyurethane/POM 94 AU 30000 PO202	NBR / POM / PA 80 NBR B246 PO 202 PA 6.G200	NBR / POM / PA 80 NBR B246 PO 202 PA 6.G200	Polyurethane 93 AU V167 93 AU V168	PTFE / NBR B602 / B276 GM 201 / B276	PTFE / FKM B602 / K655

Type	OMS-MR PR	OMS-S	OMS-S PR	KI 310	KI 320	S 8	TFMI	V 1000
Standard	ISO	ISO	ISO	ISO	ISO	ISO	ISO	ISO
Shape								
Compound	PTFE/NBR B602/NBR GM201/NBR C104/NBR	PTFE/NBR GM201/B246	PTFE/NBR B602/NBR GM201/NBR C104/NBR	Polyurethane 94 AU 925	Polyurethane/POM 94 AU 925 PO992020	NBR 70 NBR B209	PTFE/NBR PTFE 177023/NBR	NR BHNr B5A15 BHNr B5B210
Applications								











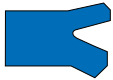

Bitte beachten Sie unsere allgemeinen Konstruktionshinweise in → Technisches Handbuch
 Daha detaylı montaj bilgisi için → Bkz. Technical Manual
 W celu zaznajomienia się z ogólnymi uwagami proszę skorzystać z Instrukcji
 Общие технические рекомендации см. → Техническое руководство

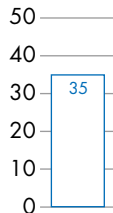
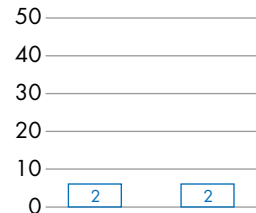
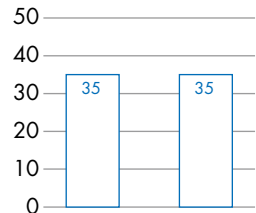
Chevron Seal Set ES / ESV		Chevron Seal Set DMS		Packing Ring TFW	H MF	H OF	FOI
ISO		ISO		ISO	ISO	ISO	ISO
							
NBR BHNBR B259	FKM BIFKM	PTFE	PTFE fabric	PTFE 15/F52902	NBR 88 NBR 101	NBR 88 NBR 101	PTFE 10/F56110
 <p>Dimensions: 40, 40</p>		 <p>Dimensions: 30, 70</p>		 <p>Dimension: 31,5</p>	 <p>Dimension: 1</p>	 <p>Dimension: 1</p>	 <p>Dimension: 30</p>
 <p>Pressure ranges: +100, -30, +140, -15</p>		 <p>Pressure ranges: +140, -15, +260, -200</p>		 <p>Pressure range: +220, -200</p>	 <p>Pressure ranges: +100, -30</p>	 <p>Pressure ranges: +100, -30</p>	 <p>Pressure range: +260, -200</p>
 <p>Viscosity ranges: 0,5, 0,5</p>		 <p>Viscosity ranges: 1,2, 0,8</p>		 <p>Viscosity range: 1,5</p>	 <p>Viscosity range: 0,5</p>	 <p>Viscosity range: 0,5</p>	 <p>Viscosity range: 15</p>
							

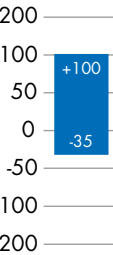
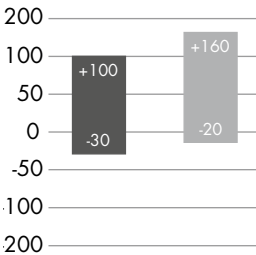
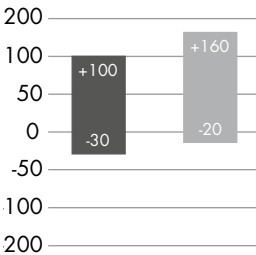
Type	N 1 / AUN 1		N 100 / AUN 100		HDR-2C	UNI	HBY		
Standard	ISO		ISO		ISO	JIS	JIS		
Shape									
Compound	NBR 90 NBR 109	Polyurethane 94 AU 925	NBR 90 NBR 109	Polyurethane 94 AU 925	Polyurethane 92 AU 21100 98 AU 928	Polyurethan 94 U801	Polyurethan / POM 94 U801 80NP	Polyurethan / POM 94 U641 80NP	Polyurethan / POM 95 UH05 80NP
Applications									

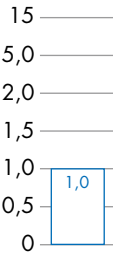
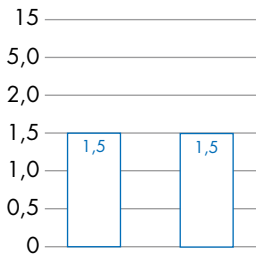
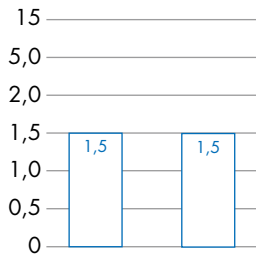
Bitte beachten Sie unsere allgemeinen Konstruktionshinweise in → Technisches Handbuch
 Daha detaylı montaj bilgisi için → Bkz. Technical Manual
 W celu zaznajomienia się z ogólnymi uwagami proszę skorzystać z Instrukcji
 Общие технические рекомендации см. → Техническое руководство

HBTS		ISI		IUH			SPN	
JIS		JIS		JIS			JIS	
								
PTFE / NBR 55YF / A305	PTFE / FKM 55YF / F201	Polyurethan 94 U801	Polyurethan 94 U641	NBR 90 NBR A505	NBR 82 NBR A567	HNBR 85 HNBR G928	PTFE / NBR 19YF / A980	PTFE / FKM 19YF / F201
								
								
								
								

Type	IDI	SPNC		SPNO	
Standard	JIS	JIS		JIS	
Shape					
Compound	Polyurethan 94 U801	PTFE / NBR 31BF / A305	PTFE / FKM 31BF / F201	PTFE / NBR 19YF / A305	PTFE / FKM 19YF / F201
					
					
					
Applications					

Bitte beachten Sie unsere allgemeinen Konstruktionshinweise in → Technisches Handbuch

Daha detaylı montaj bilgisi için → Bkz. Technical Manual

W celu zaznajomienia się z ogólnymi uwagami proszę skorzystać z Instrukcji

Общие технические рекомендации см. → Техническое руководство

STANGEN- UND SYMMETRISCHE DICHTUNGEN | ROD VE SIMETRIK SIZDIRMAZLIK ELEMANLARI USZCZELNIENIA TŁOCZYSKA ORAZ SYMETRYCZNE | ШТОКОВЫЕ И СИММЕТРИЧНЫЕ УПЛОТНЕНИЯ

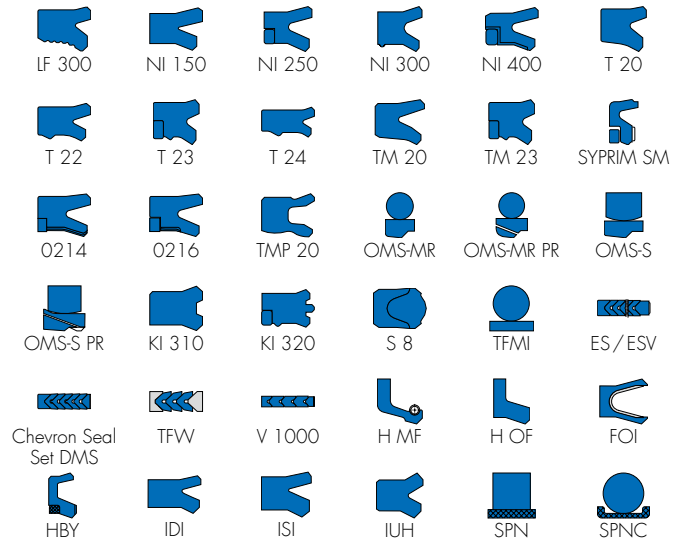
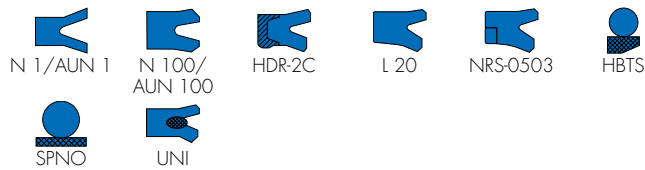
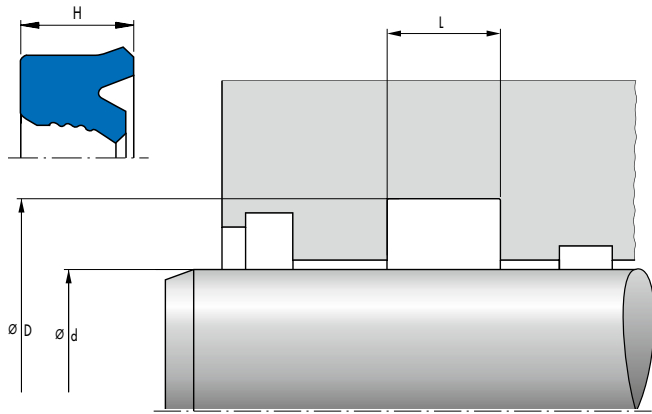

Wenn Sie Ihre Dichtung nicht finden können – Ihre Lösung auf Seite 12
Aradığınız ürünü bulamadığınız takdirde – çözümünüzü sayfa 12
Jeżeli nie możecie Państwo znaleźć uszczelki – rozwiązanie znajduje się na stronie 12
Вы не можете подобрать необходимое уплотнение? – Решение на странице 12

1) IP = Industriepackung | Endüstriyel ambalaj | Opakowania przemysłowe | Производственная тара
SP = Einzelpackung | Tek bir Paketi | Pojedyncze opakowanie | Single Pack

● Auf Lager | Stoklarda mevcuttur | Dostępne w magazynie | Имеется в наличии на складе
○ Auf Anfrage | Talep üzerine | Na zapytanie | По запросу

d [mm]	D [mm]	H [mm]	L [mm]	Material	Design	Part No.	PU ¹⁾	US	EU
2	4,9	2,1	2,4	PTFE F56110	FOI	49070543	IP		●
	4,9	2,1	2,4	PTFEVM F18232	FOI	49070548	IP		●
	10	3,8	4,5	90 NBR 109	N 1	15946 40421337	IP SP	○	● ●
3	5,9	2,1	2,4	PTFE F56110	FOI	455695	–		○
	5,9	2,1	2,4	PTFEVM F18232	FOI	49070549	IP		●
	6	2,3	2,5	31BF/70 A305	SPNC	GS2000-F0	–	○	
	7	5	6	90 NBR 109	N 1	15949 40421339	IP SP		● ●
	7,9	2	2,2	PTFE B602/NBR	OMS-MR	24361033	–		○
	8,5	4	4,7	90 NBR 109	N 1	15948 40421338	IP SP		● ●
	8,5	5	2,3	88 NBR 101	H OF	9816	–		○
	6,9	2,1	2,4	PTFE F56110	FOI	49070546	–		○
4	6,9	2,1	2,4	PTFE F56110	FOI	49310399	–		○
	6,9	2,1	2,4	PTFEVM F18232	FOI	49070550	–		○
	7	2,3	2,5	31BF/70 A305	SPNC	GS2001-F0	–	○	
	8,9	2	2,2	PTFE 55YF/70 A305	HBTS	GS5000-V6	–	○	
	8,9	2	2,2	PTFE B602/NBR	OMS-MR	24214046	–		○
	8,9	2	2,2	PTFE GM201/NBR	OMS-MR	24213512	–		○
	10	4	4,7	94 AU 925	AUN 1	13916 40421155	IP SP		● ●
	10	4	4,7	90 NBR 109	N 1	15956 40421340	IP SP		● ●
	12	4	4,7	90 NBR 109	N 1	15957 40421341	IP SP		● ●
	5	7,9	2,1	2,4	PTFE F56110	FOI	422362	IP	
8		2,3	2,5	31BF/70 A305	SPNC	GS2002-F0	–	○	

d [mm]	D [mm]	H [mm]	L [mm]	Material	Design	Part No.	PU ¹⁾	US	EU
	9,9	2	2,2	PTFE 55YF/70 A305	HBTS	GS5001-V6	-	○	
	9,9	2	2,2	PTFE B602/NBR	OMS-MR	24214048	IP		●
	9,9	2	2,2	PTFE GM201/NBR	OMS-MR	24213513	-		○
	11	5	6	90 NBR 109	N 1	15980 40421344	IP SP		● ●
	12	5	6	94 AU 925	AUN 1	14307 40421193	IP SP		● ●
5	12	5	6	90 NBR 109	N 1	15974 40421342	IP SP		● ●
	12	6	6,3	70 NBR B209	S 8	24030115	IP		●
	14	4,5	5,2	90 NBR 109	N 1	11657 40421078	IP SP		● ●
	15	5	6	90 NBR 109	N 1	15977 40421343	IP SP		● ●
	17	5,8		PTFE F52902	TFW	96598	-		○
	20	6	1,5	88 NBR 101	H OF	9824	-		○
	8,9	2,1	2,4	PTFE F56110	FOI	49080288	IP		●
	9	2,3	2,5	31BF/70 A305	SPNC	GS2003-F0	-	○	
	10,9	2	2,2	PTFE 55YF/70 A305	HBTS	GS5002-V6	-	○	
	10,9	2	2,2	PTFE B602/NBR	OMS-MR	24214050	-		○
	10,9	2	2,2	PTFE B602/FKM	OMS-MR	24332340	-		○
	10,9	2	2,2	PTFE GM201/NBR	OMS-MR	24213514	-		○
	12	4	1	88 NBR 101	H OF	9836 40421007	IP SP		● ●
	12	4	4,5	80 NBR 878	NI 150	84531 40421770 10766	IP SP -	○	● ●
	12	4	4,7	90 NBR 109	N 1	15999 40421347	IP SP		● ●
	12	6	7	94 AU 925	AUN 1	14401 40421239	IP SP		● ●
6	12	6	7	90 NBR 109	N 1	16007 40421349	IP SP		● ●
	13	6	6,3	70 NBR B209	S 8	24027634	IP		●
	14	3,8		PTFE F52902	TFW	97294	IP		●
	15	4,5	1,5	88 NBR 101	H OF	9835	-		○
	15	5	6	90 NBR 109	N 1	16001 40421348	IP SP		● ●
	15	8	9	94 AU 925	AUN 1	11760 40421083	IP SP		● ●
	16	5	6	90 NBR 109	N 1	15996 40421346	IP SP		● ●
	18	5,8		PTFE F52902	TFW	97913	IP		●
	18	8	9	90 NBR 109	N 1	15992 40421345	IP SP		● ●
	20	8	9	90 NBR 109	N 1	15991	-		○
	22	8	9	90 NBR 109	N 1	16000	-		○
	14,3	5	5,7	94 U801	IDI	FU0021-F0	-	○	
6,3	16,3	6	7	94 U801	IDI	FU0022-F0	-	○	
	16,3	7,5	8,5	94 U801	IDI	FU0023-F0	-	○	
	16,3	8	9	94 U801	IDI	FU0024-F0	-	○	
6,4	11,3	2	2,2	PTFE B602/NBR	OMS-MR	24331303	-		○
	10	2,3	2,5	31BF/70 A305	SPNC	GS2004-F0	-	○	
7	11,9	2	2,2	PTFE 55YF/70 A305	HBTS	GS5003-V6	-	○	
	11,9	2	2,2	PTFE B602/NBR	OMS-MR	24214052	-		○
	11,9	2	2,2	PTFE GM201/NBR	OMS-MR	24213515	-		○

d [mm]	D [mm]	H [mm]	L [mm]	Material	Design	Part No.	PU ¹⁾	US	EU
7	12	4	0,9	88 NBR 101	H OF	9851 40421008	IP SP		● ●
	14	3,5	4	90 NBR 109	N 1	16020 40421351	IP SP		● ●
	15	5	6	90 NBR 109	N 1	16019 40421350	IP SP		● ●
	15	7	8	94 AU 925	AUN 1	13626 40421141	IP SP		● ●
7,5	12,4	2	2,2	PTFE GM201 /NBR	OMS-MR	24293542	-		○
	10,9	2,1	2,4	PTFE F56110	FOI	435977	IP		●
	11	2,3	2,5	31BF /70 A305	SPNC	GS2005-F0	-	○	
	12,9	2	2,2	PTFE B602 /NBR	OMS-MR	24223096	-		○
	12,9	2	2,2	PTFE B602 /FKM	OMS-MR	24301528	-		○
	12,9	2	2,2	PTFE GM201 /NBR	OMS-MR	24131164	-		○
	14	4	4,5	80 NBR 878	NI 150	84532 40421771	IP SP		● ●
	14	4	4,7	90 NBR 109	N 1	16039 40421355	IP SP		● ●
	14	6	1,5	88 NBR 101	H OF	9861 40421009	IP SP		● ●
	14	6	7	94 AU 925	AUN 1	11768 40421085	IP SP	○	● ●
	14	6	7	90 NBR 109	N 1	16033 40421354	IP SP		● ●
	15	6	6,3	70 NBR B209	S 8	24007352	IP		●
	15	6	7	90 NBR 109	N 1	16030 40421353	IP SP		● ●
	15,3	2,9	3,2	PTFE 55YF /70 A305	HBTS	GS5005-V6	-	○	
	15,3	3	3,2	PTFE GM201 /NBR	OMS-MR	24131200	-		○
	15,3	3,2	3,2	PTFE B602 /NBR	OMS-MR	24178426	-		○
	16	3,8		PTFE F52902	TFW	88	IP		●
8	16	4	4,7	90 NBR 109	N 1	16040 40421356	IP SP		● ●
	16	5	5,7	94 U801	IDI	FU0039-F0	-	○	
	16	5,5	6	80 NBR 878	NI 150	84533 40421772	IP SP		● ●
	16	5,7	6,3	95 AU V142	T 20	24223246 40422213 8004-223.246	IP SP -		○
	16	6	7	94 AU 925	AUN 1	11766 40421084	IP SP		● ●
	16	6	7	90 NBR 109	N 1	16029 40421352	IP SP		● ●
	16	8	9	90 NBR 109	N 100	18047 40421574	IP SP		● ●
	16	8,2	9	95 AU V142	T 20	24223247 8004-223.247	- -	○	
	17	6	7	90 NBR 109	N 1	16044 40421358	IP SP		● ●
	18	5	1,5	88 NBR 101	H OF	9859	-		○
	18	6	7	94 U801	IDI	FU0041-F0	-	○	
	18	7,5	8,5	94 U801	IDI	FU0042-F0	-	○	
18	8	9	94 U801	IDI	FU0043-F0	-	○		
18	8	9	90 NBR 109	N 1	16042 40421357	IP SP		● ●	
20	5	1	88 NBR 101	H MF	9858	-		○	
20	5,8		PTFE F52902	TFW	35714	IP		●	
22	8	9	94 AU 925	AUN 1	14041	-		○	

d [mm]	D [mm]	H [mm]	L [mm]	Material	Design	Part No.	PU ¹⁾	US	EU
8	22	8	9	90 NBR 109	N 1	16037	-		○
	25	6	7	94 AU 925	AUN 1	13630	-		○
9	12	2,3	2,5	31BF /70 A305	SPNC	GS2006-F0	-	○	
	16	4,5	1,5	88 NBR 101	H OF	9878	-		○
	17	5	5,7	94 U801	IDI	FU0051-F0	-	○	
	17	6	7	90 NBR 109	N 1	16049 40421359	IP SP		●
	19	6	7	94 U801	IDI	FU0052-F0	-	○	
	19	7,5	8,5	94 U801	IDI	FU0053-F0	-	○	
	19	8	9	94 U801	IDI	FU0054-F0	-	○	
9,53	16,83	3	3,2	PTFE B602 /NBR	OMS-MR	24307455	-		○
10	12,9	2,1	2,4	PTFE F56110	FOI	435975	IP		●
	12,9	2,1	2,4	PTFE F56110	FOI	49301328	-		○
	13	2,3	2,5	31BF /70 A305	SPNC	GS2007-F0	-	○	
	14	3	3,2	31BF /70 A305	SPNC	GS2008-F0	-	○	
	14,5	3,2	3,6	PTFE F56110	FOI	366345	IP		●
	14,9	2	2,2	PTFE B602 /NBR	OMS-MR	24223099	IP		●
	14,9	2	2,2	PTFE B602 /FKM	OMS-MR	24260923	-		○
	14,9	2	2,2	PTFE GM201 /NBR	OMS-MR	24131165	IP		●
	14,9	2	2,2	PTFE GM201 /FKM	OMS-MR	49035480	-		○
	15	5	6	90 NBR 109	N 1	16062 40421360	IP SP		●
	15	5	6	90 NBR 109	N 1	16075 40421365	IP SP		●
	16	4	4,7	90 NBR 109	N 1	16070 40421363	IP SP		●
	16	5	2	88 NBR 101	H OF	9899	-		○
	16	5	6	90 NBR 109	N 1	16078 40421366	IP SP		●
	16	6	7	94 AU 925	AUN 1	13641 40421144	IP SP		●
	16,2	3	3,2	PTFE 177023	TFMI	97013	IP		●
	17	6	6,3	70 NBR B209	S 8	24007358	IP		●
	17,3	2,9	3,2	PTFE 55YF /70 A305	HBTS	GS5007-V6	-	○	
	17,3	3	3,2	PTFE B602 /NBR	OMS-MR	24178427	IP		●
	17,3	3	3,2	PTFE B602 /FKM	OMS-MR	24339787	-		○
	17,3	3	3,2	PTFE GM201 /NBR	OMS-MR	24131201	IP		●
	17,3	3	3,2	PTFE GM201 /FKM	OMS-MR	24267016	-		○
	18	3,8		PTFE F52902	TFW	97384	IP		●
	18	5	1,5	88 NBR 101	H OF	9893 40421011	IP SP		●
	18	5	5,7	94 U801	IDI	FU0064-F0	-	○	
	18	5	6	90 NBR 109	N 1	16068 40421362	IP SP	○	●
	18	5,5	6	80 NBR 878	NI 150	84534 40421773	IP SP	○	●
	18	5,5	6,3	94 AU 925	KI 310	401992 40421954	IP SP		●
	18	5,7	6,3	95 AU V142	T 20	24223248 40422214 8004-223.248	IP SP -		●
	18	8	9	94 AU 925	AUN 1	13640 40421143	IP SP		●
	20	6	2	88 NBR 101	H OF	9896 40421012	IP SP		●
	20	6	7	94 U801	IDI	FU0066-F0	-	○	

d [mm]	D [mm]	H [mm]	L [mm]	Material	Design	Part No.	PU ¹⁾	US	EU	
10	20	7,3	8	95 AU V142	T 20	24223249 40422215	IP SP		● ●	
	20	7,5	8,5	94 U801	IDI	FU0068-F0	-	○		
	20	8	9	94 AU 925	AUN 1	13642 40421145	IP SP		● ●	
	20	8	9	94 AU 925	AUN 100	14343 40421202	IP SP		● ●	
	20	8	9	94 U801	IDI	FU0069-F0	-	○		
	20	8	9	90 NBR 109	N 100	17744 40421540	IP SP		● ●	
	20	8	9	94 AU 925	NI 300	21258 40421602	IP SP		● ●	
	20	8,2	9	95 AU V142	T 20	24223253	-		○	
	22	5,8		PTFE F52902	TFW	110099	-		○	
	22	6	7	94 AU 925	AUN 1	13639 40421142	IP SP		● ●	
	22	6	7	90 NBR 109	N 1	16064 40421361	IP SP		● ●	
	22	8	9	94 AU 925	AUN 100	14344 40421203	IP SP		● ●	
	22	8	9	90 NBR 109	N 100	17982 40421569	IP SP		● ●	
	25	6	7	90 NBR 109	N 1	16072 40421364	IP SP		● ●	
	25	7	2	88 NBR 101	H MF	9890 40421010	IP SP		● ●	
	25	8	9	90 NBR 109	N 1	16069	-		○	
	25	10	11	90 NBR 109	N 100	17912 40421559	IP SP		● ●	
	26	8	9	90 NBR 109	N 1	16067	-		○	
	28	8	9	90 NBR 109	N 1	16059	-		○	
	28	9	10	94 AU 925	AUN 1	11780	-		○	
	30	8	2,3	88 NBR 101	H OF	9897 40421013	IP SP		● ●	
	30	10	11	90 NBR 109	N 1	16060	-		○	
	32	10	11	90 NBR 109	N 1	16076	-		○	
	11	15	3	3,2	31BF/70 A305	SPNC	GS2009-F0	-	○	
		15,9	2	2,2	PTFE GM201 /FKM	OMS-MR	49035481	-		○
		19	5,7	6,3	95 AU V142	T 20	24354784	-		○
	11,1	18,4	3	3,2	PTFE B602/NBR	OMS-MR	24307456	-		○
	11,2	15,2	3	3,2	31BF/70 A305	SPNC	GS2010-F0	-	○	
19,2		5	5,7	94 U801	IDI	FU0078-F0	-	○		
21,2		6	7	94 U801	IDI	FU0079-F0	-	○		
21,2		7,5	8,5	94 U801	IDI	FU0080-F0	-	○		
21,2		8	9	94 U801	IDI	FU0081-F0	-	○		
12	16	3	3,2	31BF/70 A305	SPNC	GS2011-F0	-	○		
	16,5	3,2	3,6	PTFE F56110	FOI	164660	IP		●	
	16,9	2	2,2	PTFE B602/NBR	OMS-MR	24223102	IP		●	
	16,9	2	2,2	PTFE B602/FKM	OMS-MR	24260924	-		○	
	16,9	2	2,2	PTFE GM201 /NBR	OMS-MR	24131166	IP		●	
	16,9	2	2,2	PTFE GM201 /FKM	OMS-MR	24343358	-		○	
	18	3	3,2	19YF/A305	SPNO	GS2800-V0	-	○		
	18	4	4,7	90 NBR 109	N 1	16104 40421369	IP SP		● ●	
	18	5	6	90 NBR 109	N 1	16109 40421370	IP SP		● ●	

d [mm]	D [mm]	H [mm]	L [mm]	Material	Design	Part No.	PU ¹⁾	US	EU
12	18	6	7	94 AU 925	AUN 1	13658 40421147	IP SP	○	● ●
	18,2	3	3,2	PTFE 177023	TFMI	96638	IP		●
	19	6	6,3	70 NBR B209	S 8	24007364	IP		●
	19,3	2,9	3,2	PTFE 55YF / 70 A305	HBTS	GS5009V6	–	○	
	19,3	3	3,2	PTFE B602 / NBR	OMS-MR	24178428	IP		●
	19,3	3	3,2	PTFE B602 / FKM	OMS-MR	24258028	–		○
	19,3	3	3,2	PTFE GM201 / NBR	OMS-MR	24131202	IP		●
	20	3,8		PTFE F52902	TFW	94496	IP		●
	20	5,5	1,5	88 NBR 101	H OF	9941	–		○
	20	5,5	6	80 NBR 878	NI 150	84535 40421774	IP SP		● ●
	20	5,5	6,3	94 AU 925	KI 310	401994 40421955	IP SP		● ●
	20	5,5	6,3	94 AU 925	NI 300	337339 40421919	IP SP		● ●
	20	5,7	6,3	95 AU V142	T 20	24223254 40422218	IP SP		● ●
	20	8	9	94 AU 925	AUN 1	14273 40421188	IP SP		● ●
	20	8	9	90 NBR 109	N 1	18035 40421573	IP SP		● ●
	20	8	9	94 AU 925	NI 300	68421 40421753	IP SP		● ●
	22	5	1,6	88 NBR 101	H OF	9937	–		○
	22	5	6	94 AU 925	AUN 1	13660	–		○
	22	5	6	90 NBR 109	N 1	16117 40421372	IP SP		● ●
	22	6	1	88 NBR 101	H OF	9936	–		○
	22	6	1,3	88 NBR 101	H MF	9944	–		○
	22	7	8	90 NBR 109	N 1	16120 40421373	IP SP		● ●
	22	7	8	94 AU 925	NI 300	337340	–		○
	22	7,3	8	95 AU V142	T 20	24223255 40422219	IP SP		● ●
	22	8	9	94 AU 925	AUN 1	13655 40421146	IP SP		● ●
	22	8	9	94 AU 925	AUN 100	14345 40421204	IP SP		● ●
	22	8	9	94 AU 925	NI 300	21261 40421603	IP SP		● ●
	22	8,2	9	95 AU V142	T 20	24187190	–		○
	24	5,8		PTFE F52902	TFW	35209	–		○
	24	6	7	90 NBR 109	N 1	16102 40421368	IP SP		● ●
	24	9	10	94 AU 925	AUN 1	14256 40421185	IP SP		● ●
	24	10	11	90 NBR 109	N 100	17978 40421568	IP SP		● ●
25	8	9	94 AU 925	AUN 1	14053 40421156	IP SP		● ●	
25	8	9	90 NBR 109	N 1	16110 40421371	IP SP		● ●	
25	10	11	94 AU 925	AUN 100	14346 40421205	IP SP		● ●	
26	8	9	90 NBR 109	N 1	16098	–		○	
26	10	11	90 NBR 109	N 100	18056 40421575	IP SP		● ●	
28	8	2	88 NBR 101	H MF	9934	–	○	○	

d [mm]	D [mm]	H [mm]	L [mm]	Material	Design	Part No.	PU ¹⁾	US	EU
12	28	10	11	90 NBR 109	N 1	16100 40421367	IP SP		● ●
	30	9	2	88 NBR 101	H MF	9942 40421015	IP SP		● ●
	30	9	10	94 AU 925	AUN 1	14052	-		○
	30	9	10	90 NBR 109	N 1	16105	-		○
	32	6	2	88 NBR 101	H OF	9933 40421014	IP SP		● ●
	34	10	11	90 NBR 109	N 1	16112	-		○
12,5	16,5	3	3,2	31BF / 70 A305	SPNC	GS2012-F0	-	○	
	20,5	5	5,7	94 U801	IDI	FU0098-F0	-	○	
	22,5	6	7	94 U801	IDI	FU0100-F0	-	○	
	22,5	7,5	8,5	94 U801	IDI	FU0101-F0	-	○	
	22,5	8	9	94 U801	IDI	FU0102-F0	-	○	
12,6	17,5	2	2,2	PTFE GM201 / NBR	OMS-MR	24312039	-		○
12,7	20	3	3,2	PTFE B602 / NBR	OMS-MR	24307457	-		○
13	17,9	2	2,2	PTFE GM201 / FKM	OMS-MR	49035512	-		○
	20	3	3,6	90 NBR 109	N 1	16143 40421375	IP SP		● ●
	22	5,5	2	88 NBR 101	H OF	9954	-		○
	24	6	7	90 NBR 109	N 1	16139 40421374	IP SP		● ●
	25	5,8		PTFE F52902	TFW	97392	-		○
	30	10	11	90 NBR 109	N 1	16135	-		○
14	18	3	3,2	31BF / 70 A305	SPNC	GS2013-F0	-	○	
	18,5	3,2	3,6	PTFE F56110	FOI	366346	IP		●
	18,9	2	2,2	PTFE B602 / NBR	OMS-MR	24223105	IP		●
	18,9	2	2,2	PTFE B602 / FKM	OMS-MR	24359902	-		○
	18,9	2	2,2	PTFE GM201 / NBR	OMS-MR	24131167	-		○
	18,9	2	2,2	PTFE GM201 / FKM	OMS-MR	24300466	-		○
	20	3	3,2	19YF / A305	SPNO	GS2801-V0	-	○	
	20	4	4,7	90 NBR 109	N 1	16152 40421377	IP SP	○	● ●
	20,2	3	3,2	PTFE 177023	TFMI	97880	IP		●
	21,3	2,9	3,2	PTFE 55YF / 70 A305	HBTS	GS5011-V6	-	○	
	21,3	3	3,2	PTFE B602 / NBR	OMS-MR	24178429	IP		●
	21,3	3	3,2	PTFE GM201 / NBR	OMS-MR	24131203	IP		●
	21,3	3	3,2	PTFE GM201 / FKM	OMS-MR	24380500	-		○
	22	4	4,7	90 NBR 109	N 1	16151 40421376	IP SP		● ●
	22	5	5,7	94 U801	IDI	FU0116-F0	-	○	
	22	5	5,7	A505	IUH	CU2692-N1	-	○	
	22	5,5	1,5	88 NBR 101	H OF	9969 40421019	IP SP		● ●
	22	5,5	6	80 NBR 878	NI 150	84536 40421775	IP SP		● ●
	22	5,5	6,3	94 AU 925	KI 310	401997 40421956	IP SP		● ●
	22	5,5	6,3	94 AU 925	NI 300	435813	-		○
22	5,7	6,3	94 AU 30000	T 20	49334142	-		○	
22	5,7	6,3	95 AU V142	T 20	24268060 40422385	IP SP		● ●	
22	6	6,3	70 NBR B209	S 8	24027629	IP		●	
22	6	7	94 AU 925	AUN 1	14059 40421157	IP SP		● ●	

d [mm]	D [mm]	H [mm]	L [mm]	Material	Design	Part No.	PU ¹⁾	US	EU
14	22	6	7	90 NBR 109	N 1	16156 40421380	IP SP		● ●
	22	8	9	94 AU 925	AUN 1	13667 40421148	IP SP		● ●
	22	8	9	90 NBR 109	N 1	16155 40421379	IP SP	○	● ●
	24	6	7	94 U801	IDI	FU0120-F0	-	○	
	24	7	2	88 NBR 101	H OF	9965 40421017	IP SP		● ●
	24	7,3	8	95 AU V142	T 20	24223256 40422220 8004-223.256	IP SP -	○	● ●
	24	7,5	8,5	94 U801	IDI	FU0121-F0	-	○	
	24	8	9	94 AU 925	AUN 100	14347 40421206	IP SP		● ●
	24	8	9	94 U801	IDI	FU0122-F0	-	○	
	24	8	9	94 AU 925	NI 300	21263 40421604	IP SP		● ●
	24	8,2	9	95 AU V142	T 20	24223257	-		○
	28	10	11	90 NBR 109	N 100	17805 40421549	IP SP		● ●
	30	7	2	88 NBR 101	H OF	9964 40421016	IP SP		● ●
	30	8	9	94 AU 925	AUN 1	13664	-		○
	30	8	9	90 NBR 109	N 1	16154 40421378	IP SP		● ●
	32	10	11	90 NBR 109	N 1	16150	-		○
33	7	2,5	88 NBR 101	H MF	9968 40421018	IP SP		● ●	
14,27	21,57	3	3,2	PTFE B602 / NBR	OMS-MR	24307458	-		○
15	19	3	3,2	31BF / 70 A305	SPNC	GS2014-F0	-	○	
	19,9	2	2,2	PTFE B602 / NBR	OMS-MR	24223108	IP		●
	19,9	2	2,2	PTFE GM201 / NBR	OMS-MR	24131168	-		○
	19,9	2	2,2	PTFE GM201 / FKM	OMS-MR	24371112	-		○
	20	3	3,6	90 NBR 109	N 1	16179 40421384	IP SP		● ●
	21,2	3	3,2	PTFE 177023	TFMI	97014	IP	○	●
	22	4	4,7	90 NBR 109	N 1	16180 40421385	IP SP		● ●
	22,3	2,9	3,2	PTFE 55YF / 70 A305	HBTS	GS5013-V6	-	○	
	22,3	3	3,2	PTFE B602 / NBR	OMS-MR	24178430	IP		●
	22,3	3	3,2	PTFE GM201 / NBR	OMS-MR	24131204	-		○
	23	5	5,7	94 U801	IDI	FU0131-F0	-	○	
	23	6	6,3	70 NBR B209	S 8	24007372	IP		●
	24	7	8	90 NBR 109	N 1	16177 40421383	IP SP		● ●
	25	5	6	90 NBR 109	N 1	16174 40421381	IP SP		● ●
	25	6	7	94 U801	IDI	FU0134-F0	-	○	
	25	8	9	94 AU 925	AUN 1	11797 40421086	IP SP		● ●
25	8	9	94 AU 925	AUN 100	11799 40421087	IP SP		● ●	
25	8	9	94 U801	IDI	FU0135-F0	-	○		
25	8	9	94 AU 925	NI 300	21265 40421605	IP SP		● ●	
25	8,2	9	95 AU V142	T 20	24223258 40422221	IP SP		● ●	

d [mm]	D [mm]	H [mm]	L [mm]	Material	Design	Part No.	PU ¹⁾	US	EU
	25	8,2	9	95 AU V142	T 22	24249943	-		○
	25,8	8	2	88 NBR 101	H OF	9975	-		○
	27	5,8		PTFE F52902	TFW	38486	IP		●
	28	8	9	94 U801	IDI	FU0136-F0	-	○	
	28	10	11	94 AU 925	AUN 100	11800	-		○
	28	10	11	94 U801	IDI	FU0137-F0	-	○	
	28	10	11	90 NBR 109	N 1	16172	-		○
15	28	10	11	90 NBR 109	N 100	17783 40421546	IP SP		● ●
	30	8	9	94 AU 925	AUN 1	13675	-		○
	30	8	9	90 NBR 109	N 1	16176 40421382	IP SP		● ●
	30	8,5	2	88 NBR 101	H MF	9976 40421020	IP SP		● ●
	30	10	11	90 NBR 109	N 100	11909 40421103	IP SP		● ●
	32	8	2,4	88 NBR 101	H MF	9978	-		○
	35	10	11	90 NBR 109	N 1	16173	-		○
15,88	23,18	3	3,2	PTFE B602/NBR	OMS-MR	24307459	-		○
	20	3	3,2	31BF/70 A305	SPNC	GS2015-F0	-	○	
	20,5	3,2	3,6	PTFE F56110	FOI	422359	IP		●
	20,9	2	2,2	PTFE B602/NBR	OMS-MR	24223111	IP		●
	20,9	2	2,2	PTFE B602/FKM	OMS-MR	24245539	-		○
	20,9	2	2,2	PTFE B602/FKM	OMS-MR	24357039	-		○
	20,9	2	2,2	PTFE C104/NBR	OMS-MR	49030550	-		○
	20,9	2	2,2	PTFE GM201/NBR	OMS-MR	24208889	IP		●
	22	3	3,2	19YF/A305	SPNO	GS2802-V0	-	○	
	22	4	4,7	94 AU 925	AUN 1	11803 40421088	IP SP	○	● ●
	22	4	4,7	90 NBR 109	N 1	16201 40421390	IP SP		● ●
	22	6	7	90 NBR 109	N 1	16194 40421387	IP SP		● ●
	22,2	3	3,2	PTFE 177023	TFMI	97881	IP		●
	23,3	2,9	3,2	PTFE 55YF/70 A305	HBTS	GS5015-V6	-	○	
16	23,3	3	3,2	PTFE B602/NBR	OMS-MR	24178431	IP		●
	23,3	3	3,2	PTFE B602/FKM	OMS-MR	24336058	-		○
	23,3	3	3,2	PTFE GM201/NBR	OMS-MR	24131205	-		○
	23,3	3	3,2	PTFE GM201/FKM	OMS-MR	24258640	-		○
	24	3,8		PTFE F52902	TFW	97393	-		○
	24	5	5,7	94 U801	IDI	FU0150-F0	-	○	
	24	5	5,7	A505	IUH	CU2548-N0	-	○	
	24	5,5	6	80 NBR 878	NI 150	84537 40421776	IP SP		● ●
	24	5,5	6,3	94 AU 925	NI 300	337342 40421920	IP SP		● ●
	24	5,7	6,3	92 AU 21100	IF 300	49016129	-		○
	24	5,7	6,3	94 AU 925	IF 300	49308195	-		○
	24	5,7	6,3	94 AU 30000	T 20	49334143	-		○
	24	5,7	6,3	95 AU V142	T 20	24223260 40422222	IP SP		● ●
	24	6	6,3	70 NBR B209	S 8	24027652	IP		●
	24	6	7	94 AU 925	KI 310	325753 40421875	IP SP	○	● ●

d [mm]	D [mm]	H [mm]	L [mm]	Material	Design	Part No.	PU ¹⁾	US	EU
16	25	5	6	90 NBR 109	N 1	16216 40421392	IP SP		● ●
	26	5	6	94 AU 925	AUN 1	14078 40421158	IP SP		● ●
	26	5	6	90 NBR 109	N 1	16192 40421386	IP SP		● ●
	26	6	7	94 U801	IDI	FU0155-F0	-	○	
	26	7,3	8	95 AU V142	T 20	24223261	-		○
	26	7,5	8,5	94 U801	IDI	FU0156-F0	-	○	
	26	8	9	94 AU 925	AUN 100	14420 40421243	IP SP		● ●
	26	8	9	94 U801	IDI	FU0157-F0	-	○	
	26	8	9	94 AU 925	NI 300	18733 40421580	IP SP		● ●
	26	8,2	9	95 AU V142	T 20	24223262	-		○
	26	18,5	18,5	BHFKM B3K674	ESV	24148034	-		○
	28	5,8		PTFE F52902	TFW	96617	IP		●
	28	6	7	94 AU 925	AUN 1	13679 40421149	IP SP		● ●
	29	6	7	90 NBR 109	N 1	16200 40421389	IP SP		● ●
	30	6	7	90 NBR 109	N 1	16207 40421391	IP SP		● ●
	31,5	6,5	2	88 NBR 101	H MF	10007 40421023	IP SP		● ●
	32	7	2	88 NBR 101	H OF	9998 40421021	IP SP		● ●
	32	8	9	94 AU 925	AUN 1	13680 40421150	IP SP		● ●
	32	8	9	90 NBR 109	N 1	16199 40421388	IP SP		● ●
	32	10	11	90 NBR 109	N 100	17802 40421548	IP SP		● ●
32	11	12	90 NBR 109	N 1	16190	-		○	
35	9	10	94 AU 925	AUN 1	14076	-		○	
35	10	2,5	88 NBR 101	H MF	10004 40421022	IP SP		● ●	
36	10	11	90 NBR 109	N 1	16197	-		○	
17	30	6	1,5	88 NBR 101	H OF	10009 40421024	IP SP		● ●
	35	10	11	94 AU 925	AUN 1	14080	-		○
17,45	24,75	3	3,2	PTFE B602/NBR	OMS-MR	24307460	-		○
18	22	3	3,2	31BF/70 A305	SPNC	GS2016-F0	-	○	
	22,5	3,2	3,6	PTFE F56110	FOI	365876	IP		●
	22,9	2	2,2	PTFE B602/NBR	OMS-MR	24223114	IP		●
	22,9	2	2,2	PTFE B602/FKM	OMS-MR	24357038	-		○
	22,9	2	2,2	PTFE GM201/NBR	OMS-MR	24131170	-		○
	22,9	2	2,2	PTFE GM201/FKM	OMS-MR	24300468	-		○
	24	3	3,2	19YF/A305	SPNO	GS2803-V0	-	○	
	24	4	4,7	90 NBR 109	N 1	16233 40421396	IP SP		● ●
	24	5	6	90 NBR 109	N 1	16230 40421394	IP SP		● ●
	24,2	3	3,2	PTFE 177023	TFMI	97525	-		○
	25	4	4,7	90 NBR 109	N 1	16232 40421395	IP SP		● ●
	25	4,5	5	80 NBR 878	NI 150	84538 40421777	IP SP		● ●

d [mm]	D [mm]	H [mm]	L [mm]	Material	Design	Part No.	PU ¹⁾	US	EU
	25	5	5,8	94 AU 925	KI 310	327022 40421907	IP SP	○	● ●
	25	6	6,3	70 NBR B209	S 8	24030522	IP		●
	25,3	2,9	3,2	PTFE 55YF/70 A305	HBTS	GS5017-V6	-	○	
	25,3	3	3,2	PTFE B602/NBR	OMS-MR	24178432	IP		●
	25,3	3	3,2	PTFE GM201/NBR	OMS-MR	24127305	IP		●
	26	4	4,7	90 NBR 109	N 1	16235 40421397	IP SP		● ●
	26	5	5,7	U641	ISI	FU0180-K2	-	○	
	26	5	5,7	U801	ISI	FU0180-K0	-	○	
	26	5	5,7	A505	IUH	CU0180-N2	-	○	
	26	5,5	1,5	88 NBR 101	H OF	10018 40421026	IP SP		● ●
	26	5,5	6,3	94 AU 925	NI 300	364610 40421932	IP SP		● ●
	26	5,7	6,3	94 AU 30000	T 20	49334144	-		○
	26	5,7	6,3	95 AU V142	T 20	24268070 40422386	IP SP		● ●
	26	6	6,3	70 NBR B209	S 8	24007379	IP		●
	26	6	7	94 AU 925	KI 310	325755 40421876	IP SP		● ●
	26	8	9	94 AU 925	NI 300	81789	-		○
	26	8,2	9	95 AU V142	T 20	24223263	-		○
	27	4,3	4,5	19YF/A980	SPN	GS2301-V0	-	○	
	28	6	7	94 U801	IDI	FU0181-F0	-	○	
	28	7,3	8	95 AU V142	T 20	24223264 40422223	IP SP	○	● ●
18	28	8	9	94 AU 925	AUN 1	13689 40421151	IP SP		● ●
	28	8	9	94 AU 925	AUN 100	11812 40421089	IP SP		● ●
	28	8	9	94 U801	IDI	FU0182-F0	-	○	
	28	8	9	90 NBR 109	N 1	17422 40421523	IP SP		● ●
	28	8	9	94 AU 925	NI 300	21266 40421606	IP SP		● ●
	28	8,2	9	95 AU V142	T 20	24187191 40422183	IP SP		● ●
	30	6	7	90 NBR 109	N 1	16238 40421398	IP SP		● ●
	30	8	9	94 AU 925	AUN 1	14088 40421160	IP SP		● ●
	30	8	9	94 AU 925	AUN 100	11813 40421090	IP SP		● ●
	30	10	11	90 NBR 109	N 100	17580 40421527	IP SP		● ●
	31	8	9	94 U801	IDI	FU0185-F0	-	○	
	31	10	11	94 U801	IDI	FU0186-F0	-	○	
	32	7	2	88 NBR 101	H OF	10017 40421025	IP SP		● ●
	32	7	8	94 AU 925	AUN 1	14084 40421159	IP SP		● ●
	32	7	8	90 NBR 109	N 1	16234	-		○
	34	8	9	94 AU 925	AUN 1	11808	-		○
	34	8	9	90 NBR 109	N 1	16227	-		○
	35	8,5	9,5	94 AU 925	AUN 1	14086	-		○
	35	8,5	9,5	90 NBR 109	N 1	16241	-		○

d [mm]	D [mm]	H [mm]	L [mm]	Material	Design	Part No.	PU ¹⁾	US	EU
18	35	12	13	90 NBR 109	N 100	17807	-		○
	38	10	11	90 NBR 109	N 1	16228 40421393	IP SP		● ●
19	26	5	6	90 NBR 109	N 1	16273 40421400	IP SP		● ●
	27	5,7	6,3	92 AU 21100	LF 300	49016138	-		○
	27	5,7	6,3	94 AU 925	LF 300	49308204	-		○
	34	8	9	90 NBR 109	N 1	16272 40421399	IP SP		● ●
19,05	26,35	3	3,2	PTFE B602/NBR	OMS-MR	24307461	-		○
20	24	3	3,2	31BF/70 A305	SPNC	GS2017F0	-	○	
	24,5	3,2	3,6	PTFE F56110	FOI	366348	IP		●
	26	3	3,2	19YF/A305	SPNO	GS2804V0	-	○	
	26	5	5,8	94 AU 925	KI 310	310005 40421862	IP SP	○	● ●
	26,2	3	3,2	PTFE 177023	TFMI	97250	IP	○	●
	27,3	3	3,2	PTFE B602/NBR	OMS-MR	24223117	IP		●
	27,3	3	3,2	PTFE B602/FKM	OMS-MR	24245538	-		○
	27,3	3	3,2	PTFE C104/NBR	OMS-MR	49030582	-		○
	27,3	3	3,2	PTFE GM201/NBR	OMS-MR	24102890	IP		●
	27,3	3	3,2	PTFE GM201/FKM	OMS-MR	24306001	-		○
	28	3,8		PTFE F52902	TFW	92	IP		●
	28	4	4,7	90 NBR 109	N 1	16294 40421405	IP SP	○	● ●
	28	5	5,7	U641	ISI	FU0212-K1	-	○	
	28	5	5,7	U801	ISI	FU0212-K0	-	○	
	28	5	5,7	A505	IUH	CU0212-N3	-	○	
	28	5	5,7	A567	IUH	CU0212-N5	-	○	
	28	5,5	6	80 NBR 878	NI 150	84539 40421778	IP SP	○	● ●
	28	5,5	6,3	94 AU 925	NI 300	337344 40421921	IP SP		● ●
	28	5,7	6,3	94 AU 30000	LF 300	49334367	-		○
	28	5,7	6,3	94 AU 925	LF 300	521486 40422042	IP SP		● ●
	28	5,7	6,3	94 AU 30000	T 20	49334145	-		○
	28	5,7	6,3	95 AU V142	T 20	24223265 40422224	IP SP	○	● ●
	28	6	6,3	70 NBR B209	S 8	24007388	IP		●
	28	6	7	94 AU 925	KI 310	325756 40421877	IP SP	○	● ●
	28	8	9	94 AU 925	AUN 1	11818 40421092	IP SP		● ●
	28	14,5	14,5	BHNBR B3B246	ES	24120639	-		○
	29	4,3	4,5	19YF/A980	SPN	GS2302V0	-	○	
30	4,7	5	PTFE GM201	OMS-S	24096118	-		○	
30	4,7	5	PTFE GM201	OMS-S	24208238	-		○	
30	6	7	94 U801	IDI	FU0214F0	-	○		
30	7,3	8	95 AU V142	T 20	24223266 40422225 8004-223.266	IP SP -	○	● ●	
30	7,3	8	95 AU V142	T 22	24250814 40422343	IP SP		● ●	
30	8	3	88 NBR 101	H OF	10038 40421033	IP SP		● ●	
30	8	9	94 AU 925	AUN 1	11817 40421091	IP SP	○	● ●	

d [mm]	D [mm]	H [mm]	L [mm]	Material	Design	Part No.	PU ¹⁾	US	EU
20	30	8	9	94 AU 925	AUN 100	11829 40421093	IP SP		● ●
	30	8	9	94 U801	IDI	FU0215-F0	-	○	
	30	8	9	90 NBR 109	N 1	16289 40421403	IP SP		● ●
	30	8	9	94 AU 925	NI 300	18735 40421581	IP SP		● ●
	30	8	9	80 NBR 878	NI 400	24338	IP		●
	30	8,2	9	95 AU V142	T 20	24187192 40422184	IP SP		● ●
	30	8,2	9	95 AU V142	T 22	24250815	-		○
	30	10	11	94 AU 925	AUN 100	11830 40421094	IP SP		● ●
	30	10	11	80 NBR 878	NI 250	18369	IP		●
	30	10	11	94 AU 925	NI 300	21269 40421607	IP SP		● ●
	30	13,5	13,5	BHNBR B3B246	ES	24077934	IP		●
	30	13,5	13,5	BHFKM B3K674	ESV	24192811	-		○
	30	16	16	BHNBR B3B246	ES	24220043	-		○
	30	16	16	BHFKM B3K674	ESV	24219984	-		○
	30	18,5	18,5	BHNBR B3B246	ES	24070179	IP		●
	30	18,5	18,5	BHFKM B3K674	ESV	24139067	-		○
	30,7	3,9	4,2	PTFE 55YF / 70 A305	HBTS	GS5019-V6	-	○	
	30,7	4	4,2	PTFE B602 / NBR	OMS-MR	24178433	IP		●
	30,7	4	4,2	PTFE B602 / FKM	OMS-MR	24263334	IP		●
	30,7	4	4,2	PTFE C104 / FKM	OMS-MR	49028183	-		○
	30,7	4	4,2	PTFE GM201 / NBR	OMS-MR	24126068	IP		●
	32	5,8		PTFE F52902	TFW	95	IP		●
	32	6	1,5	88 NBR 101	H OF	10033 40421029	IP SP		● ●
	32	7,5	8,5	94 AU 925	AUN 1	14098 40421162	IP SP		● ●
	32	7,5	8,5	90 NBR 109	N 1	16297 40421406	IP SP		● ●
	32	8	9	94 AU 925	AUN 100	14404 40421240	IP SP		● ●
	32	22,5	22,5	BHFKM B3K674	ESV	24139053	-		○
	32	27	27	MAHPT C9T003	DMS	24293250	-		○
	33	6	7	90 NBR 109	N 1	16293 40421404	IP SP		● ●
	33	8	9	94 U801	IDI	FU0220-F0	-	○	
	33	10	11	94 U801	IDI	FU0221-F0	-	○	
	35	7	2	88 NBR 101	H MF	10030 40421027	IP SP	○	● ●
	35	7	2	88 NBR 101	H OF	10047 40421034	IP SP		● ●
	35	10	11	90 NBR 109	N 1	17965 40421567	IP SP		● ●
	35	10	11	90 NBR 109	N 100	16314 40421407	IP SP		● ●
	35	10	11	80 NBR 878	NI 250	18370	-		○
	35	10	11	94 AU 925	NI 300	401667	-		○
	35	10	11	80 NBR 878	NI 400	24341	-		○
	36	8	9	94 AU 925	AUN 1	14378 40421234	IP SP		● ●
	36	8	9	90 NBR 109	N 1	16279 40421401	IP SP		● ●

d [mm]	D [mm]	H [mm]	L [mm]	Material	Design	Part No.	PU ¹⁾	US	EU
20	36	10	11	90 NBR 109	N 100	17857	-		○
	38	10	3,5	88 NBR 101	H OF	10034 40421030	IP SP		● ●
	38	12	3	88 NBR 101	H OF	10036 40421031	IP SP	○	● ●
	40	7	2	88 NBR 101	H MF	10032 40421028	IP SP		● ●
	40	8	2	88 NBR 101	H MF	10037 40421032	IP SP		● ●
	40	10	11	94 AU 925	AUN 1	14091 40421161	IP SP		● ●
	40	10	11	90 NBR 109	N 1	16288 40421402	IP SP		● ●
	40	12	13	90 NBR 109	N 100	17933 40421561	IP SP		● ●
	45	12	13	94 AU 925	AUN 1	14093	-		○
	45	12	13	90 NBR 109	N 1	17458 40421525	IP SP		● ●
20,62	27,92	3	3,2	PTFE B602/NBR	OMS-MR	24307462	-		○
21	25	3	3,2	31BF/70 A305	SPNC	GS2018F0	-	○	
22	26	3	3,2	31BF/70 A305	SPNC	GS2020F0	-	○	
	28	4,4	4,7	31BF/70 A305	SPNC	GS2019F0	-	○	
	28	4,5	5,3	94 AU 925	KI 310	310004 40421861	IP SP		● ●
	28	5	6	90 NBR 109	N 1	16339 40421412	IP SP		● ●
	28	8	9	94 AU 925	AUN 1	11834	-		○
	28,2	3	3,2	PTFE 177023	TFMI	97388	IP		●
	28,2	4,3	4,8	PTFE F56110	FOI	422373	IP		●
	29	5	5,8	94 AU 925	KI 310	332052 40421909	IP SP		● ●
	29,3	3	3,2	PTFE B602/NBR	OMS-MR	24223120	IP		●
	29,3	3	3,2	PTFE B602/FKM	OMS-MR	24332956	-		○
	29,3	3	3,2	PTFE GM201/NBR	OMS-MR	24131171	IP		●
	29,3	3	3,2	PTFE GM201/FKM	OMS-MR	24257159	-		○
	29,3	3	3,2	PTFE GM201/NBR	OMS-MR	24307954	-		○
	30	5,5	6	80 NBR 878	NI 150	84540 40421779	IP SP		● ●
	30	5,5	6,3	94 AU 925	NI 300	429357	-		○
	30	5,7	6,3	92 AU 21100	LF 300	49024530	-		○
	30	5,7	6,3	94 AU 30000	LF 300	49334368	-		○
	30	5,7	6,3	94 AU 925	LF 300	521689 40422045	IP SP		● ●
	30	5,7	6,3	94 AU 30000	T 20	49334146	-		○
	30	5,7	6,3	95 AU V142	T 20	24236862 40422321 568004-236.862	IP SP -		○
30	6	6,3	70 NBR B209	S 8	24007397	IP		●	
30	6	7	94 AU 925	AUN 1	11833 40421095	IP SP		● ●	
30	6	7	94 AU 925	KI 310	325917 40421886	IP SP		● ●	
30	6	7	90 NBR 109	N 1	16321 40421408	IP SP		● ●	
30	7	8	94 AU 925	KI 310	310003 40421860	IP SP		● ●	
30	7,3	8	95 AU V142	T 20	24249568 8004-249.568	- -		○	

d [mm]	D [mm]	H [mm]	L [mm]	Material	Design	Part No.	PU ¹⁾	US	EU
22	30	8,2	9	95 AU V142	T 20	24223267 40422226	IP SP		● ●
	30	14,5	14,5	BHNBR B3B246	ES	24120640	-		○
	31	3,8	4	19YF/A305	SPNO	GS2805-V0	-	○	
	31	4,3	4,5	19YF/A980	SPN	GS2303-V0	-	○	
	32	5	6	90 NBR 109	N 1	16334 40421411	IP SP		● ●
	32	7	8	94 AU 925	NI 300	381991	-		○
	32	7,3	8	92 AU 21100	LF 300	49024552	-		○
	32	7,3	8	94 AU 925	LF 300	49308207	-		○
	32	7,3	8	95 AU V142	T 20	24223268 40422227	IP SP		● ●
	32	7,3	8	95 AU V142	T 22	24250816	-		○
	32	8	9	94 AU 925	AUN 100	11838 40421096	IP SP		● ●
	32	8	9	94 AU 925	KI 310	326246 40421902	IP SP		● ●
	32	8	9	94 AU 925	NI 300	21271 40421608	IP SP		● ●
	32	8	9	80 NBR 878	NI 400	24349	-		○
	32	8,2	9	95 AU V142	T 20	24187193	-		○
	32	8,2	9	95 AU V142	T 22	24250817	-		○
	32	10	11	94 AU 925	NI 300	21272 40421609	IP SP		● ●
	32	13,5	13,5	BHNBR B3B246	ES	24062158	IP		●
	32	13,5	13,5	BHFKM B3K674	ESV	24144548	IP		●
	32	16	16	BHNBR B3B246	ES	24220044	-		○
	32	16	16	BHFKM B3K674	ESV	24219986	-		○
	32	18,5	18,5	BHNBR B3B246	ES	24070180	IP		●
	32	18,5	18,5	BHFKM B3K674	ESV	24148036	-		○
	32,7	3,9	4,2	PTFE 55YF/70 A305	HBTS	GS5021-V6	-	○	
	32,7	4	4,2	PTFE B602/NBR	OMS-MR	24178434	IP		●
	32,7	4	4,2	PTFE B602/FKM	OMS-MR	24290506	-		○
	32,7	4	4,2	PTFE GM201/NBR	OMS-MR	24131206	IP		●
	32,7	4	4,2	PTFE GM201/FKM	OMS-MR	24290445	-		○
	34	5,8		PTFE F52902	TFW	98944	IP		●
	34	6	2	88 NBR 101	H OF	10062 40421036	IP SP		● ●
	34	6	7	94 AU 925	AUN 1	11832	-		○
	34	6	7	90 NBR 109	N 1	16333 40421410	IP SP		● ●
	34	10	11	90 NBR 109	N 100	17846 40421550	IP SP		● ●
	34	27	27	MAHPT C9T003	DMS	24293251	-		○
	35	7	8	90 NBR 109	N 1	16340 40421413	IP SP		● ●
	35	8	9	94 AU 925	AUN 1	14106 40421163	IP SP		● ●
	35	9,1	10	95 AU V142	T 20	24369456	-		○
	35	10	11	94 AU 925	AUN 100	14349 40421207	IP SP		● ●
	35	10	11	94 U801	IDI	FU0249-F0	-	○	
	35	10	11	80 NBR 878	NI 250	18371	IP		●
	35	10	11	94 AU 925	NI 300	401668	-		○
	36	8	2,5	88 NBR 101	H MF	10068 40421037	IP SP		● ●

d [mm]	D [mm]	H [mm]	L [mm]	Material	Design	Part No.	PU ¹⁾	US	EU
	36	8	9	90 NBR 109	N 1	16341	-		○
	38	7,5	2,5	88 NBR 101	H MF	10069 40421038	IP SP		● ●
	38	8	9	90 NBR 109	N 1	16324 40421409	IP SP		● ●
22	38	10	11	90 NBR 109	N 100	17934 40421562	IP SP		● ●
	40	8	2,5	88 NBR 101	H MF	10058 40421035	IP SP		● ●
	40	10	11	94 AU 925	AUN 1	14104	-		○
	40	10	11	90 NBR 109	N 1	16322	-		○
	44	12	2,5	88 NBR 101	H OF	10065	-		○
	46	12	13	90 NBR 109	N 1	16332	-		○
22,23	29,53	3	3,2	PTFE B602/NBR	OMS-MR	24307463	-		○
	28,4	4,4	4,7	31BF/70 A305	SPNC	GS2021-F0	-	○	
	30	5	5,7	U641	ISI	FU0260-K1	-	○	
	30	5	5,7	U801	ISI	FU0260-K0	-	○	
	30	5	5,7	A505	IUH	CU3488-N0	-	○	
22,4	30,4	5	5,7	U641	ISI	FU0261-K1	-	○	
	30,4	5	5,7	U801	ISI	FU0261-K0	-	○	
	32,4	6	7	94 U801	IDI	FU0262-F0	-	○	
	32,4	8	9	94 U801	IDI	FU0263-F0	-	○	
	33,1	3,9	4,2	PTFE 55YF/70 A305	HBTS	GS5023-V6	-	○	
	35,4	8	9	94 U801	IDI	FU0264-F0	-	○	
	35,4	10	11	94 U801	IDI	FU0265-F0	-	○	
	32	5	6	90 NBR 109	N 1	16366 40421414	IP SP		● ●
23	33,7	4	4,2	PTFE B602/FKM	OMS-MR	527997	-		○
	35	5,8		PTFE F52902	TFW	38931	-		○
	35	10	11	94 AU 925	AUN 1	11844 40421097	IP SP		● ●
	35	10	11	90 NBR 109	N 1	16364	-		○
	35	10	11	94 AU 925	NI 300	336462	-		○
	43	10	11	90 NBR 109	N 1	16363	-		○
23,5	31,5	5	5,7	U641	ISI	FU0267-K1	-	○	
	31,5	5	5,7	U801	ISI	FU0267-K0	-	○	
23,8	31,1	3	3,2	PTFE B602/NBR	OMS-MR	24307464	-		○
	30	4,4	4,7	31BF/70 A305	SPNC	GS2022-F0	-	○	
	30	5	6	90 NBR 109	N 1	16383 40421417	IP SP		● ●
	30	8	9	94 AU 925	KI 310	326245	-		○
	31	5	6	94 AU 925	AUN 1	11849 40421098	IP SP		● ●
	31	5	6	90 NBR 109	N 1	16378 40421415	IP SP		● ●
24	31,3	3	3,2	PTFE B602/NBR	OMS-MR	529975	-		○
	32	4	4,7	90 NBR 109	N 1	16379 40421416	IP SP		● ●
	32	6	6,3	70 NBR B209	S 8	24027651	IP		●
	32	6	7	94 AU 925	KI 310	310002 40421859	IP SP		● ●
	32	7	8	94 AU 925	AUN 1	11850 40421099	IP SP		● ●
	34	5	6	90 NBR 109	N 1	16384 40421418	IP SP		● ●

d [mm]	D [mm]	H [mm]	L [mm]	Material	Design	Part No.	PU ¹⁾	US	EU
24	37	6	7	90 NBR 109	N 1	16386 40421419	IP SP		● ●
	40	8	9	94 AU 925	AUN 1	14255 40421184	IP SP		● ●
	40	8	9	90 NBR 109	N 1	16377	–		○
	40	10	11	90 NBR 109	N 100	17664 40421531	IP SP		● ●
	44	10	11	90 NBR 109	N 1	16385	–		○
	45	8	2	88 NBR 101	H MF	10075 40421039	IP SP		● ●
	50	12	13	94 AU 925	AUN 1	14111 40421164	IP SP		● ●
	50	12	13	90 NBR 109	N 1	16380	–		○
25	31	4,4	4,7	31BF/70 A305	SPNC	GS2023F0	–	○	
	31,2	4,3	4,8	PTFE F56110	FOI	366349	IP		●
	32	6	6,3	70 NBR B209	S 8	24060408	IP		●
	32,2	3,8	4	PTFE 177023	TFMI	97016	IP		●
	32,3	3	3,2	PTFE B602/NBR	OMS-MR	24223123	IP		●
	32,3	3	3,2	PTFE B602/FKM	OMS-MR	24245536	IP		●
	32,3	3	3,2	PTFE GM201/NBR	OMS-MR	24131172	IP		●
	33	5	5,7	U641	ISI	FU0276-K2	–	○	
	33	5	5,7	U801	ISI	FU0276-K0	–	○	
	33	5	5,7	A505	IUH	CU0276-N3	–	○	
	33	5	5,7	A567	IUH	CU0276-N5	–	○	
	33	5,5	6,3	94 AU 30000	NI 300	49334491	–		○
	33	5,5	6,3	94 AU 925	NI 300	337346 40421922	IP SP		● ●
	33	5,7	6,3	94 AU 30000	LF 300	49334369	–		○
	33	5,7	6,3	94 AU 925	LF 300	521690 40422046	IP SP		● ●
	33	5,7	6,3	94 AU 30000	T 20	49334147	–		○
	33	5,7	6,3	95 AU V142	T 20	24223269 40422228	IP SP	○	● ●
	33	6	6,3	70 NBR B209	S 8	24007407	IP		●
	33	6	7	94 AU 925	KI 310	325918 40421887	IP SP	○	● ●
	33	7	8	90 NBR 109	N 1	16400 40421424	IP SP	○	● ●
	33	8	9	94 AU 925	KI 310	310001 40421858	IP SP		● ●
	33	8,2	9	95 AU V142	T 20	24308334 8004-308.334	–	○	○
	33	14,5	14,5	BHNR B3B246	ES	24120641	–		○
	34	3,8	4	19YF/A305	SPNO	GS2806-V0	–	○	
	35	4,7	5	PTFE GM201	OMS-S	24096120	IP		●
	35	5	5,7	U641	ISI	FU0278-K2	–	○	
	35	5	5,7	U801	ISI	FU0278-K0	–	○	
	35	5	6	94 AU 925	AUN 1	11856 40421102	IP SP		● ●
35	5	6	90 NBR 109	N 1	16399 40421423	IP SP		● ●	
35	6	7	94 U801	IDI	FU0279-F0	–	○		
35	6,4	7	95 AU V142	T 20	24360709	–		○	
35	7	7,5	80 NBR 878	NI 150	84541 40421780	IP SP		● ●	
35	7	7,5	70 NBR B209	S 8	24055606	IP		●	

d [mm]	D [mm]	H [mm]	L [mm]	Material	Design	Part No.	PU ¹⁾	US	EU
25	35	7,3	8	92 AU 21100	LF 300	49024528	IP		●
	35	7,3	8	94 AU 30000	LF 300	49334380	–		○
	35	7,3	8	94 AU 925	LF 300	530049 40422078	IP SP		● ●
	35	7,3	8	95 AU V142	T 20	24223070 40422212	IP SP		● ●
	35	7,3	8	95 AU V142	T 22	24250818 40422344	IP SP		● ●
	35	8	9	94 AU 925	AUN 1	11854 40421101	IP SP		● ●
	35	8	9	94 AU 925	AUN 100	12304 40421113	IP SP		● ●
	35	8	9	94 U801	IDI	FU0282-F0	–	○	
	35	8	9	90 NBR 109	N 1	18116 40421579	IP SP		● ●
	35	8	9	94 AU 925	NI 300	21274 40421610	IP SP		● ●
	35	8	9	80 NBR 878	NI 400	24398	IP		●
	35	8,2	9	95 AU V142	T 20	24223271 40422229 8004-223.271	IP SP –	○	● ●
	35	8,2	9	95 AU V142	T 22	24250819	–		○
	35	10	11	94 AU 925	NI 300	21275 40421611	IP SP		● ●
	35	16	16	BHNBR B3B246	ES	24220045	–		○
	35	16	16	BHFKM B3K674	ESV	24219988	–		○
	35,7	3,9	4,2	PTFE 55YF / 70 A305	HBTS	GS5025-V6	–	○	
	35,7	4	4,2	PTFE B602 / NBR	OMS-MR	24178435	IP		●
	35,7	4	4,2	PTFE B602 / FKM	OMS-MR	24344719	–		○
	35,7	4	4,2	PTFE GM201 / NBR	OMS-MR	24131207	–		○
	35,7	4	4,2	PTFE B602 / NBR	OMS-MR PR	49015922	–		○
	37	5,8		PTFE F52902	TFW	98945	IP		●
	37	16,5	16,5	BHNBR B3B246	ES	24062166	–		○
	37	16,5	16,5	BHFKM B3K674	ESV	24219989	–		○
	37	22,5	22,5	BHNBR B3B246	ES	24070181	IP		●
	37	22,5	22,5	BHFKM B3K674	ESV	24148037	–		○
	38	6,5	2	88 NBR 101	H MF	10095 40421044	IP SP		● ●
	38	7	8	90 NBR 109	N 1	16401 40421425	IP SP		● ●
	38	8	9	94 U801	IDI	FU0287-F0	–	○	
	38	8,6	9,5	95 AU V142	T 20	24362136	–		○
	38	10	2,5	88 NBR 101	H OF	10089 40421040	IP SP		● ●
	38	10	11	94 AU 925	AUN 100	14351 40421208	IP SP		● ●
	38	10	11	94 U801	IDI	FU0288-F0	–	○	
	40	6	7	90 NBR 109	N 1	16397 40421422	IP SP		● ●
	40	9	10	94 U801	IDI	FU0291-F0	–	○	
	40	10	2,5	88 NBR 101	H MF	10100	–		○
	40	10	11	94 AU 925	AUN 100	14391 40421237	IP SP		● ●
	40	10	11	94 U801	IDI	FU0292-F0	–	○	
	40	10	11	90 NBR 109	N 100	17762 40421543	IP SP		● ●
	40	10	11	80 NBR 878	NI 250	18375	IP		●

d [mm]	D [mm]	H [mm]	L [mm]	Material	Design	Part No.	PU ¹⁾	US	EU
25	40	10	11	94 AU 925	NI 300	18741 40421582	IP SP		● ●
	40	10	11	80 NBR 878	NI 400	24408	-		○
	40	10	11	95 AU V142	T 20	24223272 40422230	IP SP		● ●
	40	11	12	94 AU 925	AUN 1	11853 40421100	IP SP		● ●
	40	27	27	MAHPT C9T003	DMS	24293252	-		○
	42	5,5	1,5	88 NBR 101	H OF	10090 40421041	IP SP		● ●
	42	8,5	9,5	94 AU 925	AUN 1	14116 40421165	IP SP		● ●
	42	8,5	9,5	90 NBR 109	N 1	16395 40421421	IP SP		● ●
	45	9	2	88 NBR 101	H MF	10105 40421045	IP SP		● ●
	45	10	2,5	88 NBR 101	H OF	10094	-		○
	45	10	11	94 AU 925	AUN 1	11852	-		○
	45	10	11	90 NBR 109	N 1	16393 40421420	IP SP		● ●
	45	12	3	88 NBR 101	H OF	10093 40421043	IP SP		● ●
	45	12	13	90 NBR 109	N 100	17892 40421556	IP SP		● ●
	45	12	13	94 AU 925	NI 300	401770	-		○
	50	10	2,5	88 NBR 101	H MF	10091 40421042	IP SP	○	● ●
	50	12	13	94 AU 925	AUN 1	14115	-		○
	50	12	13	90 NBR 109	N 1	16391	-		○
55	12	3	88 NBR 101	H OF	10086	-		○	
25,4	32,7	3	3,2	PTFE B602/NBR	OMS-MR	24307465	-		○
	34,56	5,9	6,5	95 AU V142	T 20	24370951	-		○
	40,5	6,3	6,3	PTFE B602/NBR	OMS-MR	24307489	-		○
25,5	31,5	4,4	4,7	31BF/70 A305	SPNC	GS2024-F0	-	○	
26	32	4,4	4,7	31BF/70 A305	SPNC	GS2025-F0	-	○	
	36	7,3	8	92 AU 21100	IF 300	49024536	-		○
	36	7,3	8	94 AU 925	IF 300	530050	-		○
	36	10	11	94 AU 925	NI 300	370114 40421935	IP SP		● ●
	36	10	11	95 AU V142	T 20	24372447	-		○
	36,7	4	4,2	PTFE B602/NBR	OMS-MR	24373908	-		○
	38	6	7	90 NBR 109	N 1	16428 40421426	IP SP		● ●
	42	8	9	90 NBR 109	N 1	16422	-		○
26,97	34,27	3	3,2	PTFE B602/NBR	OMS-MR	24307466	-		○
27	36	4,3	4,5	19YF/A980	SPN	GS2304-V0	-	○	
	36	6	7	90 NBR 109	N 1	16444 40421427	IP SP		● ●
	36	6,8	7,5	95 AU V142	T 20	24268341	-		○
	40	10	11	94 U801	IDI	FU2130-F0	-	○	
28	34	4,4	4,7	31BF/70 A305	SPNC	GS2026-F0	-	○	
	34,2	4,3	4,8	PTFE F56110	FOI	366350	IP		●
	34,2	4,3	4,8	PTFE F56110	FOI	49029924	-		○
	35,2	3,8	4	PTFE 177023	TFMI	94138	IP		●
	35,3	3	3,2	PTFE B602/NBR	OMS-MR	24223126	IP		●
	35,3	3	3,2	PTFE B602/FKM	OMS-MR	24296908	IP		●

d [mm]	D [mm]	H [mm]	L [mm]	Material	Design	Part No.	PU ¹⁾	US	EU
28	35,3	3	3,2	PTFE B602 / NBR	OMS-MR	49034768	-		○
	35,3	3	3,2	PTFE GM201 / NBR	OMS-MR	24131173	-		○
	35,3	3	3,2	PTFE GM201 / FKM	OMS-MR	24343359	-		○
	35,5	5	5,7	U641	ISI	FU0320-K1	-	○	
	35,5	5	5,7	U801	ISI	FU0320-K0	-	○	
	35,5	5	5,7	A505	IUH	CU0320-N0	-	○	
	36	5	5,7	U641	ISI	FU0321-K1	-	○	
	36	5	5,7	U801	ISI	FU0321-K0	-	○	
	36	5,5	6	80 NBR 878	NI 150	84542 40421781	IP SP	○	● ●
	36	5,7	6,3	94 AU 925	LF 300	521691 40422047	IP SP	○	● ●
	36	5,7	6,3	94 AU 30000	T 20	49334148	-		○
	36	5,7	6,3	95 AU V142	T 20	24237159 40422323 568004-237.159	IP SP -	●	● ●
	36	6	6,3	70 NBR B209	S 8	24007413	IP		●
	36	6	7	94 AU 925	KI 310	326252 40421903	IP SP		● ●
	36	8	9	94 AU 925	KI 310	326244 40421901	IP SP		● ●
	36	8	9	94 AU 925	NI 300	5148 40421004	IP SP		● ●
	36	8,2	9	95 AU V142	T 20	24249569	-		○
	36	10	11	95 AU V142	T 20	24223273	-		○
	37	3,8	4	19YF / A305	SPNO	GS2807-V0	-	○	
	38	5	6	90 NBR 109	N 1	16461 40421430	IP SP		● ●
	38	6	7	94 U801	IDI	FU0322-F0	-	○	
	38	7	8	94 AU 925	NI 300	319964	-		○
	38	7,3	8	92 AU 21100	LF 300	49024467	-		○
	38	7,3	8	94 AU 30000	LF 300	49334381	-		○
	38	7,3	8	94 AU 925	LF 300	522296 40422067	IP SP		● ●
	38	7,3	8	95 AU V142	T 20	24223274 40422231	IP SP		● ●
	38	7,3	8	95 AU V142	T 22	24250820	-		○
	38	8	9	94 AU 925	AUN 1	14131 40421166	IP SP		● ●
	38	8	9	94 U801	IDI	FU0323-F0	-	○	
	38	8	9	94 AU 925	NI 300	21280 40421612	IP SP		● ●
	38	8	9	80 NBR 878	NI 400	24426	-		○
	38	8,2	9	95 AU V142	T 20	24187195 40422185	IP SP		● ●
	38	8,2	9	95 AU V142	T 22	24250821	-		○
	38	10	11	94 AU 925	NI 300	21282 40421613	IP SP		● ●
	38	16	16	BH-NBR B3B246	ES	24120642	IP		●
	38	16	16	BF-FKM B3K674	ESV	24219990	-		○
	38,7	3,9	4,2	PTFE 55YF / 70 A305	HBTS	GS5027-V6	-	○	
	38,7	4	4,2	PTFE B602 / NBR	OMS-MR	24178436	IP		●
	38,7	4	4,2	PTFE B602 / FKM	OMS-MR	24311631	IP		●
	38,7	4	4,2	PTFE GM201 / NBR	OMS-MR	24131208	IP		●
	38,7	4	4,2	PTFE GM201 / FKM	OMS-MR	24308079	-		○

d [mm]	D [mm]	H [mm]	L [mm]	Material	Design	Part No.	PU ¹⁾	US	EU	
28	40	10	11	94 AU 925	AUN 100	14352 40421209	IP SP	○	● ●	
	40	10	11	95 AU V142	T 20	24223275 40422232	IP SP		● ●	
	40	16,5	16,5	BHNBR B3B246	ES	24062159	IP		●	
	40	16,5	16,5	BHFKM B3K674	ESV	24144546	-		○	
	40	22,5	22,5	BHNBR B3B246	ES	24070182	IP		●	
	40	22,5	22,5	BHFKM B3K674	ESV	24139068	IP		●	
	41	8	9	94 U801	IDI	FU0334-F0	-	○		
	41	10	11	94 U801	IDI	FU0335-F0	-	○		
	42	9,5	2,5	88 NBR 101	H OF	10126 40421047	IP SP		● ●	
	43	9	10	94 U801	IDI	FU0339-F0	-	○		
	43	10	11	94 U801	IDI	FU0340-F0	-	○		
	43	10	11	80 NBR 878	NI 250	18422	IP		●	
	43	10	11	94 AU 925	NI 300	21285	-		○	
	43	11,4	12,5	95 AU V142	T 20	24261406 40422374	IP SP		● ●	
	43	25	25	BHNBR B3B246	ES	24220046	-		○	
	43	25	25	BHFKM B3K674	ESV	24219991	-		○	
	43	27	27	MAHPT C9T003	DMS	24293253	-		○	
	44	8	9	94 AU 925	AUN 1	12310	-		○	
	44	8	9	90 NBR 109	N 1	16464 40421431	IP SP		● ●	
	46	6	2,3	88 NBR 101	H MF	10123 40421046	IP SP		● ●	
	46	10	11	94 AU 925	AUN 1	14127	-		○	
	46	10	11	90 NBR 109	N 1	16456 40421428	IP SP		● ●	
	48	10	11	90 NBR 109	N 1	16459 40421429	IP SP		● ●	
	48	12	13	90 NBR 109	N 100	17916 40421560	IP SP		● ●	
	49	13	3	88 NBR 101	H OF	10122	-		○	
	28,58	35,88	3	3,2	PTFE B602/NBR	OMS-MR	24307467	-		○
	29	35	4,4	4,7	31BF/70 A305	SPNC	GS2027-F0	-	○	
		37	5,7	6,3	95 AU V142	T 20	24368792	-		○
45		8	9	90 NBR 109	N 1	16479	-		○	
29,5	35,5	4,4	4,7	31BF/70 A305	SPNC	GS2028-F0	-	○		
30	36	4,4	4,7	31BF/70 A305	SPNC	GS2029-F0	-	○		
	36,2	4,3	4,8	PTFE F56110	FOI	366351	IP		●	
	37	8	9	94 AU 925	AUN 1	12319 40421115	IP SP		● ●	
	37	8	9	90 NBR 109	N 1	16487 40421434	IP SP		● ●	
	37,2	3,8	4	PTFE 177023	TFMI	97017	IP	○	●	
	37,3	3	3,2	PTFE B602/NBR	OMS-MR	24223129	IP		●	
	37,3	3	3,2	PTFE B602/FKM	OMS-MR	24268382	-		○	
	37,3	3	3,2	PTFE GM201/NBR	OMS-MR	24131174	IP		●	
	37,3	3	3,2	PTFE GM201/NBR	OMS-MR	24307953	-		○	
	37,3	3	3,2	PTFE GM201/FKM	OMS-MR	49037169	-		○	
	38	5,7	6,3	92 AU 21100	IF 300	49083240	-		○	
	38	5,7	6,3	94 AU 30000	IF 300	49334382	-		○	
38	5,7	6,3	94 AU 925	IF 300	521693 40422048	IP SP		● ●		

d [mm]	D [mm]	H [mm]	L [mm]	Material	Design	Part No.	PU ¹⁾	US	EU
	38	5,7	6,3	94 AU 30000	T 20	49334149	-		○
	38	5,7	6,3	95 AU V142	T 20	24236861 40422320 8004-236.861	IP SP -	○	● ●
	38	6	6,3	70 NBR B209	S 8	24027648	IP		●
	38	6	7	94 AU 925	KI 310	325919 40421888	IP SP	○	● ●
	38	6	7	94 AU 925	NI 300	429363	-		○
	38	8	8,5	70 NBR B209	S 8	24027626	IP		●
	38	8	9	94 AU 925	KI 310	310000 40421857	IP SP		● ●
	38	8,2	9	95 AU V142	T 20	24223276 40422233 8004-223.276	IP SP -	○	● ●
	39	3,8	4	19YF / A305	SPNO	GS2808-V0	-	○	
	40	4,7	5	PTFE GM201	OMS-S	24096122	-		○
	40	4,7	5	PTFE GM201	OMS-S	24369105	-		○
	40	5	6	94 AU 925	AUN 1	12322 40421116	IP SP		● ●
	40	5	6	90 NBR 109	N 1	16493 40421436	IP SP		● ●
	40	6	7	U641	ISI	FU0357-K3	-	○	
	40	6	7	U801	ISI	FU0357-K0	-	○	
	40	6	7	A505	IUH	CU0357-N3	-	○	
	40	6	7	A567	IUH	CU0357-N5	-	○	
	40	7,3	8	94 AU 30000	IF 300	49334383	-		○
	40	7,3	8	94 AU 925	IF 300	530774 40422082	IP SP		● ●
30	40	7,3	8	95 AU V142	T 20	49042033	IP	○	●
	40	7,3	8	95 AU V142	T 22	24289914 40422398	IP SP		● ●
	40	8	9	94 U801	IDI	FU0359-F0	-	○	
	40	10	11	94 AU 925	AUN 100	14353 40421210	IP SP	○	● ●
	40	10	11	94 AU 30000	NI 300	49334492	-		○
	40	10	11	94 AU 925	NI 300	21286 40421614 1449481	IP SP -	●	● ●
	40	10	11	94 AU 30000	T 20	49334150	-		○
	40	10	11	95 AU V142	T 20	24187196 40422186 8004-187.196	IP SP -	○	● ●
	40	10	11	95 AU V142	T 22	24250822 40422345	IP SP		● ●
	40,7	3,9	4,2	PTFE 55YF / 70 A305	HBTS	GS5029-V6	-	○	
	40,7	4	4,2	PTFE B602 / NBR	OMS-MR	24178437	IP		●
	40,7	4	4,2	PTFE B602 / FKM	OMS-MR	24263335	IP		●
	40,7	4	4,2	PTFE GM201 / NBR	OMS-MR	24108645	-		○
	40,7	4	4,2	PTFE GM201 / FKM	OMS-MR	24240669	-		○
	40,7	4	4,2	PTFE GM201 / NBR	OMS-MR PR	49013958	-		○
	41	8	9	90 NBR 109	N 1	16497	-		○
	42	5,8		PTFE F52902	TFW	99578	-		○
	42	8,7	9,6	95 AU V142	T 20	24373870	-		○
	42	10	11	94 AU 925	AUN 100	14354 40421211	IP SP		● ●
	42	10	11	90 NBR 109	N 100	17782 40421545	IP SP		● ●

d [mm]	D [mm]	H [mm]	L [mm]	Material	Design	Part No.	PU ¹⁾	US	EU
30	42	16,5	16,5	BHNBR B3B246	ES	24220047	-		○
	42	16,5	16,5	BHFKM B3K674	ESV	24219992	-		○
	42	22,5	22,5	BHNBR B3B246	ES	24070183	IP		●
	42	22,5	22,5	BHFKM B3K674	ESV	24139069	-		○
	43	10	11	94 U801	IDI	FU0364-F0	-	○	
	45	9	10	94 U801	IDI	FU0367-F0	-	○	
	45	10	11	94 AU 925	AUN 1	12317 40421114	IP SP		● ●
	45	10	11	94 AU 925	AUN 100	14355 40421212	IP SP		● ●
	45	10	11	94 U801	IDI	FU0368-F0	-	○	
	45	10	11	90 NBR 109	N 1	16490 40421435	IP SP		● ●
	45	10	11	90 NBR 109	N 100	17694 40421534	IP SP		● ●
	45	10	11	80 NBR 878	NI 250	18381	IP		●
	45	10	11	94 AU 925	NI 300	21305 40421615	IP SP		● ●
	45	10	11	80 NBR 878	NI 400	4450	IP		●
	45	10	11	95 AU V142	T 20	24223277 40422234	IP SP		● ●
	45	10	11	95 AU V142	T 22	24250823	-		○
	45	27	27	MAHPT C9T003	DMS	24293254	-		○
	48	9	2,5	88 NBR 101	H OF	10137 40421050	IP SP		● ●
	48	9	10	90 NBR 109	N 1	16496	-		○
	50	9,3		PTFE F52902	TFV	35699	-		○
	50	10	11	94 AU 925	AUN 1	14137 40421167	IP SP		● ●
	50	10	11	90 NBR 109	N 1	16486 40421433	IP SP		● ●
	50	12	3	88 NBR 101	H MF	10135 40421048	IP SP		● ●
	50	12	13	94 AU 925	AUN 100	14141 40421168	IP SP		● ●
	50	12	13	90 NBR 109	N 100	16504 40421437	IP SP		● ●
	50	12	13	94 AU 925	NI 300	401781	-		○
	50	13	3,5	88 NBR 101	H OF	10139	-		○
	52	10	2,5	88 NBR 101	H MF	10136 40421049	IP SP		● ●
	55	12	13	90 NBR 109	N 1	16485 40421432	IP SP		● ●
	55	15	16	90 NBR 109	N 1	16484	-		○
60	12	3	88 NBR 101	H MF	10140	-		○	
30,15	37,45	3	3,2	PTFE B602/NBR	OMS-MR	24307468	-		○
31	37	4,4	4,7	31BF/70 A305	SPNC	GS2030-F0	-	○	
31,5	37,5	4,4	4,7	31BF/70 A305	SPNC	GS2031-F0	-	○	
	40,5	4,3	4,5	19YF/A980	SPN	GS2305-V0	-	○	
	41,5	6	7	U641	ISI	FU0382-K1	-	○	
	41,5	6	7	U801	ISI	FU0382-K0	-	○	
	41,5	8	9	94 U801	IDI	FU0383-F0	-	○	
	44,5	8	9	94 U801	IDI	FU0384-F0	-	○	
	44,5	10	11	94 U801	IDI	FU0385-F0	-	○	
	46,5	9	10	94 U801	IDI	FU0386-F0	-	○	
	46,5	10	11	94 U801	IDI	FU0387-F0	-	○	

d [mm]	D [mm]	H [mm]	L [mm]	Material	Design	Part No.	PU ¹⁾	US	EU
31,75	39,05	3	3,2	PTFE B602 / NBR	OMS-MR	24307469	-		○
32	38	4,4	4,7	31BF / 70 A305	SPNC	GS2032F0	-	○	
	38,2	4,3	4,8	PTFE F56110	FOI	366352	IP		●
	39,2	3,8	4	PTFE 177023	TFMI	97879	IP		●
	39,3	3	3,2	PTFE B602 / NBR	OMS-MR	24223132	IP		●
	39,3	3	3,2	PTFE B602 / FKM	OMS-MR	24250622	-		○
	39,3	3	3,2	PTFE GM201 / NBR	OMS-MR	24131175	-		○
	40	4	4,7	90 NBR 109	N 1	16510 40421440	IP SP		● ●
	40	5,5	6,3	94 AU 925	NI 300	406663	-		○
	40	5,7	6,3	92 AU 21100	LF 300	49024532	-		○
	40	5,7	6,3	94 AU 925	LF 300	530051	-		○
	40	5,7	6,3	94 AU 30000	T 20	49334151	-		○
	40	5,7	6,3	95 AU V142	T 20	24234472 40422313 568004-234.472	IP SP -	●	●
	40	6	6,3	70 NBR B209	S 8	24023604	IP		●
	40	6	7	94 AU 925	KI 310	326253 40421904	IP SP		● ●
	40	6,5	7,5	94 AU 925	NI 300	315748 40421870	IP SP		● ●
	40	7	8	90 NBR 109	N 1	16517 40421445	IP SP		● ●
	40	8	9	94 AU 925	KI 310	326239 40421898	IP SP		● ●
	40	8	9	94 AU 925	NI 300	429370 40421984	IP SP		● ●
	40	8,2	9	95 AU V142	T 20	24258895 40422373	IP SP		● ●
	41	3,8	4	19YF / A305	SPNO	GS2809V0	-	○	
	42	4,7	5	PTFE GM201	OMS-S	24096123	-		○
	42	7	7,5	80 NBR 878	NI 150	84543 40421782	IP SP		● ●
	42	7,1	8	92 AU 21100	HDR-2C	49305017	IP		●
	42	7,3	8	92 AU 21100	LF 300	49024534	-		○
	42	7,3	8	94 AU 925	LF 300	521694 40422049	IP SP		● ●
	42	7,3	8	95 AU V142	T 20	24223278 40422235 568004-223.278	IP SP -	●	●
	42	7,3	8	95 AU V142	T 22	24250824 40422346	IP SP		● ●
	42	8	9	94 AU 925	KI 310	311592 40421869	IP SP		● ●
	42	8,2	9	95 AU V142	T 20	24249570	-		○
	42	10	11	94 AU 925	NI 300	21306 40421616	IP SP		● ●
	42	10	11	95 AU V142	T 20	24223279 40422236 8004-223.279	IP SP -	○	●
	42	10	11	95 AU V142	T 22	24250825 40422347	IP SP		● ●
42	16	16	BI-NBR B3B246	ES	24120643	-		○	
42	16	16	BHFKM B3K674	ESV	24219993	-		○	
42,7	3,9	4,2	PTFE 55YF / 70 A305	HBTS	GS5031-V6	-	○		
42,7	4	4,2	PTFE B602 / NBR	OMS-MR	24178438	IP		●	
42,7	4	4,2	PTFE B602 / FKM	OMS-MR	24296466	-		○	
42,7	4	4,2	PTFE GM201 / NBR	OMS-MR	24122880	IP		●	

d [mm]	D [mm]	H [mm]	L [mm]	Material	Design	Part No.	PU ¹⁾	US	EU	
32	42,7	4	4,2	PTFE B602 / NBR	OMS-MR PR	49015921	IP		●	
	44	6	7	90 NBR 109	N 1	16512 40421442	IP SP		● ●	
	44	8,2	9	95 AU V142	T 20	24369393	-		○	
	44	16,5	16,5	BHNBR B3B246	ES	24078187	-		○	
	44	16,5	16,5	BHFKM B3K674	ESV	24191167	-		○	
	44	22,5	22,5	BHNBR B3B246	ES	24070184	IP		●	
	44	22,5	22,5	BHFKM B3K674	ESV	24139070	-		○	
	45	6,5	7,5	94 AU 925	AUN 1	14147	-		○	
	45	6,5	7,5	90 NBR 109	N 1	16511 40421441	IP SP		● ●	
	45	10	11	94 AU 925	AUN 100	14356 40421213	IP SP		● ●	
	45	10	11	90 NBR 109	N 100	17547 40421526	IP SP		● ●	
	45	10	11	80 NBR 878	NI 250	18386	IP		●	
	45	10	11	94 AU 925	NI 300	401826 40421952	IP SP		● ●	
	47	10	11	94 AU 925	NI 300	21307 40421617	IP SP		● ●	
	47	10	11	80 NBR 878	NI 400	24466	IP		●	
	47	10	11	95 AU V142	T 20	24187197 40422187	IP SP		● ●	
	47	10	11	95 AU V142	T 22	24250826	-		○	
	47	25	25	BHNBR B3B246	ES	24327287	-		○	
	47	25	25	BHFKM B3K674	ESV	24219994	-		○	
	47	27	27	MAHPT C9T003	DMS	24293255	-		○	
	48	8	9	90 NBR 109	N 1	16506 40421438	IP SP		● ●	
	48	8	9	90 NBR 109	N 1	16514 40421443	IP SP		● ●	
	50	10	11	94 AU 925	AUN 1	14149 40421169	IP SP		● ●	
	50	10	11	90 NBR 109	N 1	16516 40421444	IP SP		● ●	
	50	12	13	90 NBR 109	N 100	17784 40421547	IP SP		● ●	
	51	15	3,5	88 NBR 101	H OF	10167 40421052	IP SP		● ●	
	52	10	11	94 AU 925	AUN 1	14145	-		○	
	52	10	11	90 NBR 109	N 1	16508 40421439	IP SP		● ●	
	55	10	2,5	88 NBR 101	H MF	10165 40421051	IP SP		● ●	
	33	43	6	7	90 NBR 109	N 1	16534 40421446	IP SP		● ●
	33,32	40,62	3	3,2	PTFE B602 / NBR	OMS-MR	24307470	-		○
	34	40	4,4	4,7	31BF / 70 A305	SPNC	GS2033-F0	-	○	
41,3		3	3,2	PTFE B602 / NBR	OMS-MR	531851	-		○	
44		6,4	7	95 AU V142	T 20	24368632	-		○	
45		7	8	94 AU 925	AUN 1	12341	-		○	
46		5,8		PTFE F52902	TFW	39032	-		○	
50	12	13	94 U801	IDI	FU0408-F0	-	○			
34,93	42,23	3	3,2	PTFE B602 / NBR	OMS-MR	24307471	-		○	
35	41	4,4	4,7	31BF / 70 A305	SPNC	GS2034-F0	-	○		
	42,2	3,8	4	PTFE 177023	TFMI	97018	IP		●	
	42,3	3	3,2	PTFE B602 / NBR	OMS-MR	24223135	IP		●	

d [mm]	D [mm]	H [mm]	L [mm]	Material	Design	Part No.	PU ¹⁾	US	EU
	42,3	3	3,2	PTFE B602 / FKM	OMS-MR	24309807	-		○
	42,3	3	3,2	PTFE GM201 / NBR	OMS-MR	24131176	-		○
	42,3	3	3,2	PTFE GM201 / FKM	OMS-MR	24309806	-		○
	43	5,7	6,3	92 AU 21100	LF 300	49024468	-		○
	43	5,7	6,3	94 AU 925	LF 300	530052 40422079	IP SP		● ●
	43	5,7	6,3	94 AU 30000	T 20	49334152	-		○
	43	5,7	6,3	95 AU V142	T 20	24236860 40422319 8004-236.860	IP SP -	○	● ●
	43	6	6,3	70 NBR B209	S 8	24027649	IP		●
	43	6	7	94 AU 925	KI 310	309999 40421856	IP SP		● ●
	43	6	7	94 AU 925	NI 300	429378	-		○
	43	6,8	7,5	95 AU V142	T 20	24360144	-		○
	45	4,7	5	PTFE GM201	OMS-S	24096124	IP		●
	45	6	7	U641	ISI	FU0424K7	-	○	
	45	6	7	U801	ISI	FU0424K0	-	○	
	45	6	7	A505	IUH	CU0424-N3	-	○	
	45	6	7	A567	IUH	CU0424-N5	-	○	
	45	6	7	90 NBR 109	N 1	16547 40421447	IP SP		● ●
	45	6	7	90 NBR 109	N 1	16552 40421450	IP SP		● ●
	45	7,3	8	92 AU 21100	LF 300	49024470	IP		●
	45	7,3	8	94 AU 30000	LF 300	49334384	-		○
35	45	7,3	8	94 AU 925	LF 300	521706 40422059	IP SP		● ●
	45	7,3	8	95 AU V142	T 20	49045114	IP		●
	45	7,5	8	70 NBR B209	S 8	24007446	IP		●
	45	8	9	94 AU 925	AUN 1	12344 40421117	IP SP		● ●
	45	8	9	94 U801	IDI	FU0427F0	-	○	
	45	10	11	94 AU 925	AUN 100	14357 40421214	IP SP		● ●
	45	10	11	94 AU 30000	NI 300	49334493	-		○
	45	10	11	94 AU 925	NI 300	18756 40421583	IP SP	○	● ●
	45	10	11	94 AU 30000	T 20	49334153	-		○
	45	10	11	95 AU V142	T 20	24187198 40422188	IP SP		● ●
	45	10	11	95 AU V142	T 22	24250827 40422348	IP SP		● ●
	45,7	3,9	4,2	PTFE 55YF / 70 A305	HBTS	GS5033-V6	-	○	
	45,7	4	4,2	PTFE B602 / NBR	OMS-MR	24178439	IP		●
	45,7	4	4,2	PTFE B602 / FKM	OMS-MR	24296131	-		○
	45,7	4	4,2	PTFE GM201 / NBR	OMS-MR	24131209	IP		●
	47	5,8		PTFE F52902	TFW	39047	IP		●
	47	16,5	16,5	BHNBR B3B246	ES	24062171	-		○
	47	16,5	16,5	BHFKM B3K674	ESV	24219995	-		○
	47	22,5	22,5	BHNBR B3B246	ES	24070185	IP		●
	47	22,5	22,5	BHFKM B3K674	ESV	24139071	-		○
	48	7	2,5	88 NBR 101	H OF	10186	-		○
	48	10	11	94 AU 925	AUN 100	12262 40421110	IP SP		● ●

d [mm]	D [mm]	H [mm]	L [mm]	Material	Design	Part No.	PU ¹⁾	US	EU
	50	7		PTFE F52902	TFW	39060	-		○
	50	8	9	90 NBR 109	N 1	16553 40421451	IP SP	○	● ●
	50	9	10	94 U801	IDI	FU0436-F0	-	○	
	50	10	11	94 AU 925	AUN 100	14390 40421236	IP SP	○	● ●
	50	10	11	94 U801	IDI	FU0437-F0	-	○	
	50	10	11	90 NBR 109	N 100	17910 40421558	IP SP		● ●
	50	10	11	80 NBR 878	NI 250	18389	IP		●
	50	10	11	94 AU 925	NI 300	18759 40421584 2991379	IP SP -	●	● ●
	50	10	11	80 NBR 878	NI 400	3967	-		○
	50	10	11	95 AU V142	T 20	24187199 40422189	IP SP		● ●
	50	10	11	95 AU V142	T 22	24250828	-		○
	50	12	13	94 U801	IDI	FU0438-F0	-	○	
	50	27	27	MAI-PT C9T003	DMS	24293256	-		○
	51	8	9	90 NBR 109	N 1	16549 40421448	IP SP		● ●
35	52	11,8	13	95 AU V142	T 20	24374124	-		○
	52	12	13	90 NBR 109	N 100	18074 40421578	IP SP		● ●
	55	10	11	94 AU 925	AUN 1	14152 40421170	IP SP		● ●
	55	10	11	90 NBR 109	N 1	11664 40421079	IP SP		● ●
	55	10	11	90 NBR 109	N 100	16563 40421452	IP SP		● ●
	55	12	13	94 AU 925	AUN 100	14318 40421195	IP SP		● ●
	55	12	13	90 NBR 109	N 100	17649	-		○
	56	10	11	90 NBR 109	N 1	16559	-		○
	58	8,5	2,5	88 NBR 101	H MF	10182 40421053 10182F	IP SP -	○	● ●
	60	12	3	88 NBR 101	H MF	10185	-		○
	60	12	13	94 AU 925	AUN 1	14154	-		○
	60	12	13	90 NBR 109	N 1	16550 40421449	IP SP		● ●
	60	15	3	88 NBR 101	H OF	10181	-		○
	60	15	3	88 NBR 101	H OF	10183 40421054	IP SP		● ●
	41,5	4,4	4,7	31BF/70 A305	SPNC	GS2035-F0	-	○	
	45	6	7	U641	ISI	FU0451-K1	-	○	
	45	6	7	U801	ISI	FU0451-K0	-	○	
	45	6	7	A505	IUH	CU0451-N2	-	○	
35,5	45,5	6	7	U641	ISI	FU0452-K1	-	○	
	45,5	6	7	U801	ISI	FU0452-K0	-	○	
	45,5	8	9	94 U801	IDI	FU0453-F0	-	○	
	46,2	3,9	4,2	PTFE 55YF/70 A305	HBTS	GS5035-V6	-	○	
	50,5	9	10	94 U801	IDI	FU0455-F0	-	○	
	50,5	10	11	94 U801	IDI	FU0456-F0	-	○	
	51,5	10	11	94 U801	IDI	FU0457-F0	-	○	
	51,5	12	13	94 U801	IDI	FU0458-F0	-	○	
36	42	4,4	4,7	31BF/70 A305	SPNC	GS2036-F0	-	○	

d [mm]	D [mm]	H [mm]	L [mm]	Material	Design	Part No.	PU ¹⁾	US	EU
	42,2	4,3	4,8	PTFE F56110	FOI	366353	IP		●
	43,2	3,8	4	PTFE 177023	TFMI	96706	-		○
	43,3	3	3,2	PTFE B602/NBR	OMS-MR	24223138	IP		●
	43,3	3	3,2	PTFE B602/FKM	OMS-MR	24246483	-		○
	43,3	3	3,2	PTFE GM201/NBR	OMS-MR	24131177	IP		●
	43,3	3	3,2	PTFE GM201/FKM	OMS-MR	24246941	-		○
	44	5,7	6,3	94 AU 30000	T 20	49334154	-		○
	44	5,7	6,3	95 AU V142	T 20	24266873 40422378 568004-266.873	IP SP -	●	● ●
	44	6	6,3	70 NBR B209	S 8	24007448	IP		●
	44	6	7	94 AU 925	KI 310	325920 40421889	IP SP		● ●
	44	6	7	94 AU 925	NI 300	429359	-		○
	44	8	9	94 AU 925	KI 310	326241 40421899	IP SP		● ●
	44	8,2	9	94 AU 30000	T 20	49334155	-		○
	44	8,2	9	95 AU V142	T 20	24355159 40422489	IP SP	○	● ●
	45	3,8	4	19YF/A305	SPNO	GS2810-V0	-	○	
	46	4,7	5	PTFE GM201	OMS-S	24096125	-		○
	46	6	7	U641	ISI	FU2921-K0	-	○	
	46	6	7	U801	ISI	FU2921-K1	-	○	
	46	6	7	A505	IUH	CU3040-N0	-	○	
	46	6	7	90 NBR 109	N 1	16571 40421455	IP SP		● ●
	46	7	7,5	80 NBR 878	NI 150	84544 40421783	IP SP	○	● ●
36	46	7	8	94 AU 925	NI 300	319965 40421873	IP SP		● ●
	46	7,3	8	94 AU 30000	LF 300	49334385	-		○
	46	7,3	8	94 AU 925	LF 300	521695 40422050	IP SP		● ●
	46	7,3	8	94 AU 30000	T 20	49334156	-		○
	46	7,3	8	95 AU V142	T 20	24223280 40422237 8004-223.280	IP SP -	○	● ●
	46	10	11	94 AU 925	NI 300	21315 40421618	IP SP		● ●
	46	10	11	95 AU V142	T 20	24187200 40422190 8004-187.200	IP SP -	○	● ●
	46	10	11	95 AU V142	T 22	24250829 40422349	IP SP		● ●
	46	16	16	BHNBR B3B246	ES	24120644	-		○
	46	16	16	BHFKM B3K674	ESV	24219996	-		○
	46	22,5	22,5	BHFKM B3K674	ESV	527783	-		○
	46,7	3,9	4,2	PTFE 55YF/70 A305	HBTS	GS5037-V6	-	○	
	46,7	4	4,2	PTFE B602/NBR	OMS-MR	24178440	IP		●
	46,7	4	4,2	PTFE B602/FKM	OMS-MR	24315180	-		○
	46,7	4	4,2	PTFE GM201/NBR	OMS-MR	24113843	IP		●
	46,7	4	4,2	PTFE GM201/FKM	OMS-MR	24251017	-		○
	46,7	4	4,2	PTFE B602/NBR	OMS-MR PR	49022316	-		○
	48	5,8		PTFE F52902	TFW	36086	-		○
	48	6	7	90 NBR 109	N 1	16568 40421454	IP SP		● ●
	48	7,3	8	95 AU V142	T 20	24314092	-		○

d [mm]	D [mm]	H [mm]	L [mm]	Material	Design	Part No.	PU ¹⁾	US	EU	
36	48	10	11	95 AU V142	T 20	24267642 40422384	IP SP		● ●	
	48	16,5	16,5	BHNBR B3B246	ES	24084373	IP		●	
	48	16,5	16,5	BHFKM B3K674	ESV	24149112	-		○	
	48	22,5	22,5	BHNBR B3B246	ES	24070186	IP		●	
	48	22,5	22,5	BHFKM B3K674	ESV	24138994	IP		●	
	50	7	8	90 NBR 109	N 1	16573 40421456	IP SP		● ●	
	50	10	11	95 AU V142	T 20	24345948	-		○	
	51	10	11	80 NBR 878	NI 250	18423	-		○	
	51	10	11	94 AU 925	NI 300	21317 40421619	IP SP		● ●	
	51	10	11	80 NBR 878	NI 400	24467	IP		●	
	51	10	11	95 AU V142	T 20	24358522	-		○	
	51	11,4	12,5	95 AU V142	T 20	24269445 40422387	IP SP		● ●	
	51	25	25	BHNBR B3B246	ES	24327286	IP		●	
	51	25	25	BHFKM B3K674	ESV	24219997	-		○	
	52	13	14,3	95 AU V142	T 20	24375441	-		○	
	55	10	11	90 NBR 109	N 1	16566 40421453	IP SP		● ●	
	56	12	13	94 AU 925	NI 300	21324 40421620	IP SP		● ●	
	59,8	10	2,5	88 NBR 101	H OF	10195	-		○	
	36,5	43,8	3	3,2	PTFE B602/NBR	OMS-MR	24307472	-		○
	37	47	7,3	8	94 AU 925	IF 300	522297	-		○
47		8	9	94 AU 925	NI 300	368268 40421934	IP SP		● ●	
47		10	11	94 AU 925	NI 300	375755 40421937	IP SP		● ●	
47		10	11	95 AU V142	T 20	24369267	-		○	
47,7		4	4,2	PTFE B602/NBR	OMS-MR	24298971	-		○	
38		44	4,4	4,7	31BF/70 A305	SPNC	GS2037-F0	-	○	
	45	6	7	94 AU 925	KI 310	326242 40421900	IP SP		● ●	
	45,2	3,8	4	PTFE 177023	TFMI	96303	-		○	
	48	7,3	8	92 AU 21100	IF 300	49024506	-		○	
	48	7,3	8	94 AU 925	IF 300	49308194	-		○	
	48,7	4	4,2	PTFE B602/NBR	OMS-MR	24223141	-		○	
	48,7	4	4,2	PTFE GM201/NBR	OMS-MR	24196775	-		○	
	50	6	7	90 NBR 109	N 1	16586 40421457	IP SP		● ●	
	50	9	10	94 AU 925	AUN 1	13758 40421152	IP SP	○	● ●	
	53,1	5,9	6,3	PTFE 55YF/70 A305	HBTS	GS5039-V6	-	○		
	53,1	5,9	6,3	PTFE B602/NBR	OMS-MR	24223144	-		○	
	53,1	5,9	6,3	PTFE GM201/NBR	OMS-MR	24223679	-		○	
	55	10	11	94 AU 925	AUN 100	14323 40421199	IP SP	○	● ●	
	55	10	11	94 AU 925	NI 300	401832	-		○	
55	10	11	95 AU V142	NI 300	49035015	-		○		
58	9,3		PTFE F52902	TFW	39074	-		○		
58	10	2,5	88 NBR 101	H OF	10201	-		○		
58	10	11	94 AU 925	AUN 1	14165 40421171	IP SP		● ●		

d [mm]	D [mm]	H [mm]	L [mm]	Material	Design	Part No.	PU ¹⁾	US	EU	
38	58	10	11	90 NBR 109	N 1	16587	IP		●	
	58	12	13	90 NBR 109	N 100	17789	-		○	
	58	12	13	80 NBR 878	NI 250	18394	-		○	
	60	12	13	90 NBR 109	N 1	16593	-		○	
39	45	4	4,7	90 NBR 109	N 1	16600	-		○	
	45	4,4	4,7	31BF / 70 A305	SPNC	GS2038F0	-	○		
	49,7	4	4,2	PTFE B602 / NBR	OMS-MR	24334988	-		○	
40	46	4	4,7	90 NBR 109	N 1	16619 40421461	IP SP		● ●	
	46	4,4	4,7	31BF / 70 A305	SPNC	GS2039F0	-	○		
	46,2	4,3	4,8	PTFE F56110	FOI	366354	IP		●	
	47,2	3,8	4	PTFE 177023	TFMI	97019	IP		●	
	47,3	3	3,2	PTFE B602 / NBR	OMS-MR	24334196	-		○	
	48	5,7	6,3	94 AU 30000	T 20	49334157	-		○	
	48	5,7	6,3	95 AU V142	T 20	24239428 40422327 8004-239.428	IP SP -	●	● ●	
	48	6	6,3	70 NBR B209	S 8	24007461	IP		●	
	48	6	7	94 AU 925	KI 310	325921 40421890	IP SP	○	● ●	
	48	8	8,5	70 NBR B209	S 8	24073042	IP		●	
	48	8	9	94 AU 925	KI 310	309998 40421855	IP SP		● ●	
	48	8	9	90 NBR 109	N 1	16629 40421464	IP SP		● ●	
	48	8	9	94 AU 925	NI 300	429264	-		○	
	48	8,2	9	94 AU 30000	T 20	49334158	-		○	
	48	8,2	9	95 AU V142	T 20	24223281 40422238	IP SP		● ●	
	48	11	11,7	70 NBR B209	S 8	24007465	-		○	
	49	3,8	4	19YF / A305	SPNO	GS2811-V0	-	○		
	50	5	6	90 NBR 109	N 1	16615 40421460 1661535	IP SP -		○	● ●
	50	6	7	U641	ISI	FU0497-K5	-	○		
	50	6	7	U801	ISI	FU0497-K0	-	○		
	50	6	7	A505	IUH	CU0497-N4	-	○		
	50	6	7	A567	IUH	CU0497-N6	-	○		
	50	7	7,5	80 NBR 878	NI 150	84545 40421784	IP SP		● ●	
	50	7	8	94 AU 925	NI 300	319563 40421872	IP SP		● ●	
	50	7	8	U801 / S813	UNI	FU2002-M1	-	○		
	50	7,1	8	92 AU 21100	HDR-2C	49078196	-		○	
	50	7,3	8	92 AU 21100	LF 300	49024505	-		○	
	50	7,3	8	94 AU 30000	LF 300	49334386	-		○	
	50	7,3	8	94 AU 925	LF 300	521696 40422051	IP SP		● ●	
	50	7,3	8	94 AU 30000	T 20	49334159	-		○	
	50	7,3	8	95 AU V142	T 20	24223283 40422240	IP SP	○	● ●	
	50	7,3	8	95 AU V142	T 22	24250830 40422350	IP SP		● ●	
50	7,5	8	70 NBR B209	S 8	24007467	IP		●		
50	8	8	94 AU 925	KI 320	351889	-		○		

d [mm]	D [mm]	H [mm]	L [mm]	Material	Design	Part No.	PU ¹⁾	US	EU
40	50	8	9	94 AU 925	AUN 1	14179 40421176	IP SP		● ●
	50	8	9	94 U801	IDI	FU0498-F0	-	○	
	50	8,2	9	95 AU V142	T 20	24223282 40422239	IP SP		● ●
	50	8,2	9	95 AU V142	T 22	24250831	-		○
	50	9	10	90 NBR 109	N 100	18024 40421572	IP SP		● ●
	50	10	11	94 AU 925	AUN 100	14398 40421238	IP SP	○	● ●
	50	10	11	94 AU 30000	NI 300	49334494	-		○
	50	10	11	94 AU 925	NI 300	18760 40421585	IP SP	○	● ●
	50	10	11	94 AU 30000	T 20	49334160	-		○
	50	10	11	95 AU V142	T 20	24187702 40422204	IP SP	○	● ●
	50	10	11	95 AU V142	T 22	24250832 40422351	IP SP		● ●
	50	16	16	BHNBR B3B246	ES	24120645	IP		●
	50	16	16	BHFKM B3K674	ESV	24219998	-		○
	50,7	4	4,2	PTFE B602 / NBR	OMS-MR	24223147	IP		●
	50,7	4	4,2	PTFE B602 / FKM	OMS-MR	24238040	-		○
	50,7	4	4,2	PTFE GM201 / NBR	OMS-MR	24131178	IP		●
	50,7	4	4,2	PTFE B602 / NBR	OMS-MR PR	49008897	IP		●
	52	5,8		PTFE F52902	TFW	39160	IP		●
	52	8	9	90 NBR 109	N 1	16627 40421463	IP SP		● ●
	52	9	9,5	70 NBR B209	S 8	24030126	IP		●
	52	16,5	16,5	BHNBR B3B246	ES	24062173	IP		●
	52	16,5	16,5	BHFKM B3K674	ESV	24175597	-		○
	52	22,5	22,5	BHNBR B3B246	ES	24070187	IP		●
	52	22,5	22,5	BHFKM B3K674	ESV	24139072	-		○
	55	7	7,5	PTFE GM201	OMS-S	24096126	-		○
	55	7	7,5	PTFE GM201	OMS-S	24233905	-		○
	55	9	10	94 U801	IDI	FU0504-F0	-	○	
	55	9,5	10,5	90 NBR 109	N 100	18063 40421576	IP SP		● ●
	55	10	11	94 AU 925	AUN 100	14358 40421215	IP SP		● ●
	55	10	11	94 U801	IDI	FU0505-F0	-	○	
	55	10	11	90 NBR 109	N 1	16630 40421465	IP SP		● ●
	55	10	11	80 NBR 878	NI 250	18396	IP		●
	55	10	11	94 AU 925	NI 300	21326 40421621	IP SP		● ●
	55	10	11	80 NBR 878	NI 400	24468	IP		●
	55	10	11	95 AU V142	T 20	24187203 40422191	IP SP		● ●
	55	10	11	95 AU V142	T 22	24250833 40422352	IP SP		● ●
	55	11,4	12,5	95 AU V142	T 20	24261407 40422375	IP SP		● ●
	55	11,4	12,5	95 AU V142	T 23	24302155	-		○
	55	11,5	12,5	94 AU 925	NI 300	337351	-		○
	55	25	25	BHNBR B3B246	ES	24220050	IP		●
55	25	25	BHFKM B3K674	ESV	24219999	-		○	

d [mm]	D [mm]	H [mm]	L [mm]	Material	Design	Part No.	PU ¹⁾	US	EU
	55	27	27	MAHPT C9T003	DMS	24293258	-		○
	55,1	5,9	6,3	PTFE 55YF / 70 A305	HBTS	GS5041-V6	-	○	
	55,1	5,9	6,3	PTFE B602 / NBR	OMS-MR	24178441	IP		●
	55,1	5,9	6,3	PTFE B602 / FKM	OMS-MR	24262761	-		○
	55,1	5,9	6,3	PTFE B602 / NBR	OMS-MR	49008558	-		○
	55,1	5,9	6,3	PTFE GM201 / NBR	OMS-MR	24113841	IP		●
	55,1	5,9	6,3	PTFE GM201 / FKM	OMS-MR	24240917	-		○
	55,1	5,9	6,3	PTFE B602 / NBR	OMS-MR PR	49030512	-		○
	55,1	5,9	6,3	95 AU V142	SYPRIM SM	24360070 0536-360.070	- -	●	○
	55,5	6	6,3	U641 / 12NM	HBV	FG0253-F4	-	○	
	55,5	6	6,3	U801 / 12NM	HBV	FG0253-F3	-	○	
	56	8	9	90 NBR 109	N 1	16611 40421459	IP SP		● ●
	56	10	11	94 AU 925	AUN 1	14177 40421175	IP SP		● ●
	56	10	11	94 U801	IDI	FU0508-F0	-	○	
	56	10	11	90 NBR 109	N 1	16621 40421462	IP SP		● ●
	56	10	11	90 NBR 109	N 100	17662 40421530	IP SP		● ●
	56	12	13	94 U801	IDI	FU0509-F0	-	○	
	58	8,5	4	88 NBR 101	H MF	10223 40421061	IP SP		● ●
	58	11,4	12,5	95 AU V142	T 20	24360465	-		○
	60	10	2,5	88 NBR 101	H MF	10218 40421057	IP SP	○	● ●
40	60	10	11	94 AU 925	AUN 1	14174 40421173	IP SP		● ●
	60	10	11	90 NBR 109	N 1	16610 40421458	IP SP		● ●
	60	12	13	90 NBR 109	N 100	17698 40421536	IP SP		● ●
	60	12	13	80 NBR 878	NI 250	18397	-		○
	60	12	13	94 AU 925	NI 300	21338 40421622	IP SP		● ●
	60	12	13	80 NBR 878	NI 400	24479	-		○
	60	13	14	94 AU 925	AUN 100	14169 40421172	IP SP		● ●
	64	12	13	90 NBR 109	N 1	16617	-		○
	65	9,5	3	88 NBR 101	H OF	10222 40421060	IP SP		● ●
	65	11,2		PTFE F52902	TFW	39171	-		○
	65	12	13	94 AU 925	AUN 1	14176 40421174	IP SP		● ●
	65	12	13	90 NBR 109	N 1	16608	-		○
	66	10	3	88 NBR 101	H OF	10216 40421056	IP SP		● ●
	67	9,5	2,5	88 NBR 101	H MF	10214 40421055	IP SP		● ●
	70	15	2,5	88 NBR 101	H MF	10220 40421058	IP SP	○	● ●
	70	15	16	90 NBR 109	N 1	16609	-		○
	70	16	4	88 NBR 101	H OF	10221 40421059	IP SP		● ●
	80	20	21	90 NBR 109	N 1	16612	-		○
40,5	51,2	4	4,2	PTFE B602 / NBR	OMS-MR	49023393	-		○

d [mm]	D [mm]	H [mm]	L [mm]	Material	Design	Part No.	PU ¹⁾	US	EU
41	47	4,4	4,7	31BF / 70 A305	SPNC	GS2040-F0	-	○	
	51,7	4	4,2	PTFE B602 / NBR	OMS-MR	24257621	IP		●
42	48	4,4	4,7	31BF / 70 A305	SPNC	GS2041-F0	-	○	
	49,2	3,8	4	PTFE 177023	TFMI	98323	-		○
	50	5,7	6,3	95 AU V142	T 20	24261932 40422376	IP SP	○	● ●
	50	6	6,3	70 NBR B209	S 8	24007475	IP		●
	50	6	7	94 AU 925	KI 310	325757 40421878	IP SP		● ●
	50	6	7	90 NBR 109	N 1	16654 40421468 1665464	IP SP -	○	● ● ●
	52	10	11	94 AU 925	NI 300	116182 40421851	IP SP		● ●
	52	10	11	95 AU V142	T 20	24223284 40422241	IP SP		● ●
	52,7	4	4,2	PTFE B602 / NBR	OMS-MR	24223150	IP		●
	52,7	4	4,2	PTFE B602 / FKM	OMS-MR	24300453	-		○
	52,7	4	4,2	PTFE GM201 / NBR	OMS-MR	24131179	-		○
	55	6,5	7,5	90 NBR 109	N 1	16649 40421466	IP SP		● ●
	57,1	5,9	6,3	PTFE 55YF / 70 A305	HBTS	GS5043-V6	-	○	
	57,1	5,9	6,3	PTFE B602 / NBR	OMS-MR	24178442	IP		●
	57,1	5,9	6,3	PTFE B602 / FKM	OMS-MR	24314958	-		○
	57,1	5,9	6,3	PTFE GM201 / NBR	OMS-MR	24131210	-		○
62	10	11	90 NBR 109	N 1	16652 40421467	IP SP		● ●	
62	12	13	90 NBR 109	N 100	17935 40421563	IP SP		● ●	
62	12	13	80 NBR 878	NI 250	18398	-		○	
74	15	4	88 NBR 101	H OF	10234	-		○	
43	53	7,3	8	94 AU 925	IF 300	530053	-		○
	53	10	11	94 AU 925	NI 300	413930	-		○
	63	10	11	90 NBR 109	N 1	16657	-		○
44	50	4,4	4,7	31BF / 70 A305	SPNC	GS2042-F0	-	○	
	52	5,7	6,3	95 AU V142	T 20	24292881	-		○
	54,7	4	4,2	PTFE B602 / NBR	OMS-MR	24327355	-		○
	55	6	7	90 NBR 109	N 1	16661 40421469	IP SP		● ●
	55	10	10,6	70 NBR B209	S 8	24094781	IP		●
	56	6	2,5	88 NBR 101	H OF	10240	-		○
	59,1	5,9	6,3	PTFE B602 / NBR	OMS-MR	24298970	-		○
	60	8	2,5	88 NBR 101	H OF	10239	-		○
44,45	59,53	5,9	6,3	PTFE B602 / FKM	OMS-MR	24354866	-		○
	59,55	6,3	6,3	PTFE B602 / NBR	OMS-MR	24307499	-		○
44,5	54	6,5	7,1	95 AU V142	T 20	24333357	-		○
45	51	4,4	4,7	31BF / 70 A305	SPNC	GS2043-F0	-	○	
	52	8	9	90 NBR 109	N 1	16672 40421470	IP SP		● ●
	52,2	3,8	4	PTFE 177023	TFMI	97020	-		○
	53	8	8,5	70 NBR B209	S 8	24060410	IP		●
	53	8	9	94 AU 925	KI 310	309997 40421854	IP SP		● ●
	53	8,2	9	95 AU V142	T 20	24223285 40422242	IP SP		● ●

d [mm]	D [mm]	H [mm]	L [mm]	Material	Design	Part No.	PU ¹⁾	US	EU
	53	10,9	12	95 AU V142	T 24	24309792	-		○
	54	3,8	4	19YF/A305	SPNO	GS2812-V0	-	○	
	54,4	6,6	7,1	PTFE F56110	FOI	366355	IP		●
	55	6	7	U641	ISI	FU0567-K6	-	○	
	55	6	7	U801	ISI	FU0567-K0	-	○	
	55	6	7	A505	IUH	CU0567-N4	-	○	
	55	6	7	A567	IUH	CU0567-N6	-	○	
	55	7	7,5	80 NBR 878	NI 150	84546 40421785	IP SP		● ●
	55	7	8	94 AU 925	KI 310	331369 40421908	IP SP		● ●
	55	7	8	94 AU 925	NI 300	429849 40421985	IP SP	○	● ●
	55	7	8	U801/S813	UNI	FU0568-M1	-	○	
	55	7,1	8	92 AU 21100	HDR-2C	49311261	IP		●
	55	7,3	8	92 AU 21100	LF 300	49042413	-		○
	55	7,3	8	94 AU 30000	LF 300	49334387	-		○
	55	7,3	8	94 AU 925	LF 300	521697 40422052	IP SP		● ●
	55	7,3	8	94 AU 30000	T 20	49334161	-		○
	55	7,3	8	95 AU V142	T 20	24223286 40422243 568004-223.286	IP SP -	●	● ●
	55	7,5	8	70 NBR B209	S 8	24007485	IP		●
	55	8	8	94 AU 925	KI 320	351890	IP	○	●
	55	8	9	94 U801	IDI	FU0569-F0	-	○	
45	55	10	11	94 AU 925	AUN 100	14359 40421216	IP SP	○	● ●
	55	10	11	94 AU 30000	NI 300	49334495	-		○
	55	10	11	94 AU 925	NI 300	18763 40421586	IP SP	○	● ●
	55	10	11	94 AU 30000	T 20	49334163	-		○
	55	10	11	95 AU V142	T 20	24223287 40422244	IP SP		● ●
	55	10	11	95 AU V142	T 22	24250834 40422353	IP SP		● ●
	55	16	16	BHNBR B3B246	ES	24120646	IP		●
	55	16	16	BHFKM B3K674	ESV	24220000	-		○
	55,7	4	4,2	PTFE B602/NBR	OMS-MR	24223153	IP		●
	55,7	4	4,2	PTFE B602/FKM	OMS-MR	24260922	IP		●
55,7	4	4,2	PTFE GM201/NBR	OMS-MR	24131180	IP		●	
55,7	4	4,2	PTFE B602/NBR	OMS-MR PR	49005182	-		○	
56	4	4,2	PTFE B602/NBR	OMS-MR	24343009	-		○	
56	7	8	A505	IUH	CU0572-N1	-	○		
57	6	7	90 NBR 109	N 1	16679 40421474	IP SP		● ●	
57	8,7	9,6	95 AU V142	T 20	24373871	-		○	
58	6,5	7,5	90 NBR 109	N 1	16677 40421473	IP SP		● ●	
58	10	11	90 NBR 109	N 100	17858 40421553	IP SP		● ●	
60	7	7,5	PTFE GM201	OMS-S	24096128	-		○	
60	7		PTFE F52902	TFW	34161	-		○	
60	9	10	94 U801	IDI	FU0575-F0	-	○		
60	10	11	94 AU 925	AUN 100	14360 40421217	IP SP	○	● ●	

d [mm]	D [mm]	H [mm]	L [mm]	Material	Design	Part No.	PU ¹⁾	US	EU
	60	10	11	94 U801	IDI	FU0577-F0	-	○	
	60	10	11	90 NBR 109	N 100	35153 40421745	IP SP		● ●
	60	10	11	80 NBR 878	NI 250	18399	IP		●
	60	10	11	94 AU 925	NI 300	18764 40421587	IP SP		● ●
	60	10	11	80 NBR 878	NI 400	24489	IP		●
	60	10	11	95 AU V142	T 20	24187204 40422192	IP SP		● ●
	60	10	11	95 AU V142	T 22	24250835 40422354	IP SP		● ●
	60	11,5	12,5	94 AU 925	NI 300	381990	-		○
	60	16,5	16,5	BHNBR B3B246	ES	24062175	IP		●
	60	16,5	16,5	BHFKM B3K674	ESV	24149108	IP		●
	60	22,5	22,5	BHNBR B3B246	ES	24070189	IP		●
	60	22,5	22,5	BHFKM B3K674	ESV	24138993	IP		●
	60	25	25	BHNBR B3B246	ES	24327285	IP		●
	60	25	25	BHFKM B3K674	ESV	24220001	-		○
	60,1	5,9	6,3	PTFE 55YF / 70 A305	HBTS	GS5045-V6	-	○	
	60,1	5,9	6,3	PTFE B602 / NBR	OMS-MR	24178443	IP		●
	60,1	5,9	6,3	PTFE B602 / FKM	OMS-MR	24334150	-		○
	60,1	5,9	6,3	PTFE GM201 / NBR	OMS-MR	24101569	IP		●
	60,1	5,9	6,3	PTFE GM201 / FKM	OMS-MR	24332693	-		○
	60,1	5,9	6,3	95 AU V142	SYPRIM SM	24355139 0536-355.139	IP -	●	●
45	60,5	6	6,3	U641 / 12NM	HBY	FG0254-F6	-	○	
	60,5	6	6,3	U801 / 12NM	HBY	FG0254-F5	-	○	
	61	10	11	94 U801	IDI	FU0579-F0	-	○	
	61	12	13	94 U801	IDI	FU0580-F0	-	○	
	63	10	11	94 AU 925	AUN 1	14192 40421178	IP SP		● ●
	63	10	11	90 NBR 109	N 1	16673 40421471	IP SP		● ●
	65	8,5	2,5	88 NBR 101	H MF	10244 40421062	IP SP		● ●
	65	9,3		PTFE F52902	TFW	182	-		○
	65	10	11	94 AU 925	AUN 1	14188 40421177	IP SP		● ●
	65	10	11	90 NBR 109	N 1	16674 40421472	IP SP		● ●
	65	12	13	94 AU 925	AUN 100	35601 40421746	IP SP		● ●
	65	12	13	90 NBR 109	N 100	16693 40421475	IP SP		● ●
	65	12	13	80 NBR 878	NI 250	18400	-		○
	65	12	13	94 AU 925	NI 300	21339	-		○
	65	12	13	80 NBR 878	NI 400	24541	-		○
	65	31	31	MAHPT C9T003	DMS	24293259	-		○
	70	12	3	88 NBR 101	H OF	10247 40421063	IP SP		● ●
	70	12	13	94 AU 925	AUN 1	14191	-		○
	70	12	13	90 NBR 109	N 1	16676	-		○
	75	8	2	88 NBR 101	H OF	10246	-		○
46	52	4,4	4,7	31BF / 70 A305	SPNC	GS2044-F0	-	○	
	56	7,3	8	92 AU 21100	IF 300	49024504	-		○

d [mm]	D [mm]	H [mm]	L [mm]	Material	Design	Part No.	PU ¹⁾	US	EU
46	56	7,3	8	94 AU 925	LF 300	530054 40422080	IP SP		● ●
	56	7,3	8	95 AU V142	T 20	24375268	-		○
	56	10	11	94 AU 925	NI 300	413959	-		○
	56,7	4	4,2	PTFE B602/NBR	OMS-MR	24342771	-		○
	61,1	5,9	6,3	PTFE GM201/NBR	OMS-MR	24338408	-		○
47	55	8	9	94 AU 925	KI 310	326243	-		○
	59	9,6	10,5	95 AU V142	T 20	24360464	-		○
	60	7,3	7,5	19YF/A980	SPN	GS2306-V0	-	○	
	62,1	5,9	6,3	PTFE B602/NBR	OMS-MR	24351654	-		○
	63	12	13	94 U801	IDI	FU0591-F0	-	○	
48	54	4,4	4,7	31BF/70 A305	SPNC	GS2046-F0	-	○	
	56	8,2	9	95 AU V142	T 20	24233879	-		○
	58	7	7,5	31BF/70 A305	SPNC	GS2045-F0	-	○	
	58	7,3	8	92 AU 21100	LF 300	49308224	-		○
	58	7,3	8	94 AU 925	LF 300	526668 40422071	IP SP		● ●
	58,7	4	4,2	PTFE B602/NBR	OMS-MR	24360762	-		○
	60	6	7	90 NBR 109	N 1	16707 40421476	IP SP		● ●
	60	9	10	94 AU 925	AUN 1	13789 40421153	IP SP		● ●
	60	10	10,6	70 NBR B209	S 8	24055751	IP		●
	63,1	5,9	6,3	PTFE B602/NBR	OMS-MR	24233638	-		○
	65	10	11	90 NBR 109	N 1	16715	-		○
	68	10	11	90 NBR 109	N 1	16709	-		○
	68	12	13	90 NBR 109	N 100	17625	-		○
	68	12	13	80 NBR 878	NI 250	18401	-		○
	75	12	3	88 NBR 101	H MF	10253	-		○
49	55	4,4	4,7	31BF/70 A305	SPNC	GS2047-F0	-	○	
	65	8	9	90 NBR 109	N 1	16722	-		○
49,5	60,2	4	4,2	PTFE B602/NBR	OMS-MR	49023396	-		○
50	56	4,4	4,7	31BF/70 A305	SPNC	GS2049-F0	-	○	
	56	8	9	90 NBR 109	N 1	11666 40421080	IP SP		● ●
	57,2	3,8	4	PTFE 177023	TFMI	97021	IP		●
	58	5,7	6,3	92 AU 21100	LF 300	49308410	-		○
	58	5,7	6,3	94 AU 30000	LF 300	49334388	-		○
	58	5,7	6,3	94 AU 925	LF 300	522298 40422068	IP SP		● ●
	58	8	8,5	70 NBR B209	S 8	24117303	IP		●
	58	8	9	94 AU 925	KI 310	309996 40421853	IP SP		● ●
	58	8	9	94 AU 925	NI 300	429254	-		○
	58	8	9	95 AU V142	T 20	24290848 8004-290.848	-	○	
	58	8,2	9	95 AU V142	T 20	24223250 40422216 8004-223.250	IP SP -	○	
	58	10,9	12	95 AU V142	T 24	24309793	-		○
	59	8	9	94 AU 925	NI 300	420826 40421960	IP SP		● ●
	59,4	6,6	7,1	PTFE F56110	FOI	366356	IP		●
	60	6	7	U641	ISI	FU0619K3	-	○	

d [mm]	D [mm]	H [mm]	L [mm]	Material	Design	Part No.	PU ¹⁾	US	EU
	60	6	7	U801	ISI	FU0619K0	–	○	
	60	6	7	A505	IUH	CU0619N3	–	○	
	60	6	7	A567	IUH	CU0619N5	–	○	
	60	7	7,5	80 NBR 878	NI 150	84547 40421786	IP SP		● ●
	60	7	7,5	31BF/70 A305	SPNC	GS2048F0	–	○	
	60	7	8	94 AU 925	KI 310	326519 40421905	IP SP		● ●
	60	7,1	8	92 AU 21100	HDR-2C	49305018	IP		●
	60	7,3	8	92 AU 21100	LF 300	49024466	IP		●
	60	7,3	8	94 AU 30000	LF 300	49334389	–		○
	60	7,3	8	94 AU 925	LF 300	49306976	IP		●
	60	7,3	8	94 AU 30000	T 20	49334164	–		○
	60	7,3	8	95 AU V142	T 20	24223251 40422217 568004-223.251	IP SP –		● ● ●
	60	7,3	8	95 AU V142	T 22	24250836 40422355 8048-250.836	IP SP –		● ● ●
	60	7,5	8	70 NBR B209	S 8	24007494	IP		●
	60	8	9	94 U801	IDI	FU0620F0	–	○	
	60	10	10,6	70 NBR B209	S 8	24135436	–		○
	60	10	11	94 AU 925	AUN 100	14361 40421218	IP SP	○	● ●
	60	10	11	90 NBR 109	N 1	16740 40421480	IP SP		● ●
	60	10	11	94 AU 30000	NI 300	49334496	–		○
50	60	10	11	94 AU 925	NI 300	18765 40421588	IP SP	○	● ●
	60	10	11	94 AU 30000	T 20	49334165	–		○
	60	10	11	95 AU V142	T 20	24187205 40422193	IP SP		● ●
	60	10	11	95 AU V142	T 22	24250837 40422356	IP SP		● ●
	60	16	16	BHNBR B3B246	ES	24120647	–		○
	60	16	16	BHFKM B3K674	ESV	24220002	–		○
	60,7	4	4,2	PTFE B602/NBR	OMS-MR	24223156	IP		●
	60,7	4	4,2	PTFE B602/FKM	OMS-MR	24232029	–		○
	60,7	4	4,2	PTFE GM201/NBR	OMS-MR	24131181	IP		●
	60,7	4	4,2	PTFE GM201/FKM	OMS-MR	24266914	–		○
	60,7	4	4,2	PTFE B602/NBR	OMS-MR PR	49009141	IP		●
	60,7	4	4,2	PTFE GM201/NBR	OMS-MR PR	49022785	–		○
	62	5,8		PTFE F52902	TFW	39315	–		○
	62	6	7	90 NBR 109	N 1	16735 40421479	IP SP	○	● ●
	62	9	9,5	70 NBR B209	S 8	24091914	IP		●
	62	9	10	94 AU 925	AUN 1	14211 40421180	IP SP		● ●
	62	10	11	95 AU V142	T 20	24223289 40422245	IP SP		● ●
	63	6	7	94 AU 925	AUN 1	13799 40421154	IP SP		● ●
	63	10	11	U801/S813	UNI	FU1925-M1	–	○	
	65	6,3	6,5	19YF/A305	SPNO	GS2813-V0	–	○	
	65	7	7,5	PTFE GM201	OMS-S	24096129	IP		●
	65	9	10	94 U801	IDI	FU0630F0	–	○	

d [mm]	D [mm]	H [mm]	L [mm]	Material	Design	Part No.	PU ¹⁾	US	EU
50	65	10	11	94 AU 925	AUN 100	14362 40421219	IP SP		● ●
	65	10	11	94 U801	IDI	FU0631-F0	-	○	
	65	10	11	80 NBR 878	NI 250	18402	IP		●
	65	10	11	94 AU 925	NI 300	21344 40421623	IP SP		● ●
	65	10	11	80 NBR 878	NI 400	24575	IP	○	●
	65	10	11	95 AU V142	T 20	24187206 40422194 8004-187.206	IP SP -	○	● ●
	65	10	11	95 AU V142	T 22	24245251 40422340	IP SP		● ●
	65	11,4	12,5	94 AU 30000	T 20	49334166	-		○
	65	11,4	12,5	95 AU V142	T 20	24223290 40422246	IP SP	○	● ●
	65	11,4	12,5	95 AU V142	T 23	24302156	-		○
	65	11,5	12,5	94 AU 925	NI 300	457406	-		○
	65	12	13	90 NBR 109	N 100	18000 40421570	IP SP		● ●
	65	12,5	12,5	94 AU 925	KI 320	351892	IP	○	●
	65	16,5	16,5	BHNBR B3B246	ES	24062178	IP		●
	65	16,5	16,5	BHFKM B3K674	ESV	24186958	-		○
	65	22,5	22,5	BHNBR B3B246	ES	24070190	IP		●
	65	22,5	22,5	BHFKM B3K674	ESV	24139074	IP		●
	65	25	25	BHNBR B3B246	ES	24327284	IP		●
	65	25	25	BHFKM B3K674	ESV	24220003	-		○
	65,1	5,9	6,3	PTFE 55YF / 70 A305	HBTS	GS5047-V6	-	○	
	65,1	5,9	6,3	PTFE B602 / NBR	OMS-MR	24178444	IP		●
	65,1	5,9	6,3	PTFE B602 / FKM	OMS-MR	24262762	IP		●
	65,1	5,9	6,3	PTFE GM201 / NBR	OMS-MR	24131211	IP		●
	65,1	5,9	6,3	PTFE GM201 / FKM	OMS-MR	49005400	-		○
	65,1	5,9	6,3	PTFE B602 / NBR	OMS-MR PR	49023489	IP		●
	65,1	5,9	6,3	PTFE C104 / NBR	OMS-MR PR	49029429	IP		●
	65,1	5,9	6,3	PTFE GM201 / NBR	OMS-MR PR	49004614	IP		●
	65,1	5,9	6,3	95 AU V142	SYPRIM SM	24341750 0536-341.750	IP -	●	●
	65,5	6	6,3	U641 / 12NM	HBV	FQ0255-F3	-	○	
	65,5	6	6,3	U801 / 12NM	HBV	FQ0255-F4	-	○	
	65,5	6	6,3	UH05 / 12NM	HBV	FQ0255-F7	-	○	
	66	10	11	94 U801	IDI	FU0634-F0	-	○	
66	12	13	94 U801	IDI	FU0635-F0	-	○		
70	9,3		PTFE F52902	TFW	186	-		○	
70	10	11	94 AU 925	AUN 1	14207 40421179	IP SP		● ●	
70	10	11	90 NBR 109	N 1	16728 40421477	IP SP	○	● ●	
70	11,4	12,5	95 AU V142	T 22	24289912	-		○	
70	11,4	13	95 AU V142	T 20	24223291 40422247	IP SP		● ●	
70	11,4	13	95 AU V142	T 22	24291788	-		○	
70	12	3	88 NBR 101	H MF	10259 40421065	IP SP		● ●	
70	12	13	94 AU 925	AUN 100	14267 40421186	IP SP		● ●	
70	12	13	94 U801	IDI	FU0639-F0	-	○		

d [mm]	D [mm]	H [mm]	L [mm]	Material	Design	Part No.	PU ¹⁾	US	EU	
50	70	12	13	90 NBR 109	N 100	17650 40421529	IP SP		● ●	
	70	12	13	80 NBR 878	NI 250	18403	IP		●	
	70	12	13	94 AU 925	NI 300	21349 40421624	IP SP		● ●	
	70	12	13	80 NBR 878	NI 400	24591	IP		●	
	70	14,6	16	93 AU V167	TMP 20	24377712	-		○	
	70	18	19	94 AU 925	AUN 1	14212 40421181	IP SP		● ●	
	70	31	31	MAHPT C9T003	DMS	24293260	-		○	
	72	12	13	90 NBR 109	N 1	16730 40421478	IP SP		● ●	
	74	12	13	90 NBR 109	N 1	16734	-		○	
	75	12,5	13,5	94 AU 925	AUN 1	14210	-		○	
	75	15	16	90 NBR 109	N 100	17827	-		○	
	76	10	3	88 NBR 101	H OF	10258 40421064	IP SP		● ●	
	80	15	16	90 NBR 109	N 1	16727	-		○	
	80	16	4	88 NBR 101	H OF	10262	-		○	
	90	12	3	88 NBR 101	H MF	10263	-		○	
	50,8	60,3	6,5	7,1	95 AU V142	T 20	24333369	-		○
		65,9	5,9	6,3	PTFE GM201 / NBR	OMS-MR	24299047	-		○
		65,9	6,3	6,3	PTFE B602 / NBR	OMS-MR	24307502	-		○
		66,7	12,3	13,5	95 AU V142	T 20	24296042	-		○
69,85		11,8	13,5	95 AU V142	T 20	24333466	-		○	
51	61,4	6,4	7	95 AU V142	T 20	24362578 40422494	IP SP		● ●	
	61,7	4	4,2	PTFE GM201 / NBR	OMS-MR	24355760	-		○	
	63	6	7	90 NBR 109	N 1	16755 40421481	IP SP		● ●	
51,5	62,2	4,2	4,2	PTFE B602 / NBR	OMS-MR	49020322	-		○	
52	60	5,5	6,3	94 AU 925	KI 310	366034	-		○	
	62	6	7	90 NBR 109	N 1	16763 40421482	IP SP		● ●	
	62	6,4	7	95 AU V142	T 20	24374053	-		○	
	62	7	7,5	31BF / 70 A305	SPNC	GS2050-F0	-	○		
	62	7,3	8	92 AU 21100	LF 300	49024503	-		○	
	62	7,3	8	94 AU 925	LF 300	530055	-		○	
	62	10	11	94 AU 925	NI 300	112670 40421850	IP SP		● ●	
	62	12	13	94 AU 925	AUN 100	12296 40421111	IP SP		● ●	
	62,7	4	4,2	PTFE B602 / NBR	OMS-MR	24343702	-		○	
	64	5,8		PTFE F52902	TFV	39318	-		○	
	67,1	5,9	6,3	PTFE B602 / NBR	OMS-MR	24329222	-		○	
	70	9	10	94 AU 925	AUN 1	14250	-		○	
	72	12	13	90 NBR 109	N 100	17755 40421541	IP SP		● ●	
	72	12	13	80 NBR 878	NI 250	18405	-		○	
	53	63	6	7	U641	ISI	FU0679-K2	-	○	
63		6	7	U801	ISI	FU0679-K0	-	○		
63		6	7	G928	IUH	CU0679-N0	-	○		
63		7	7,5	31BF / 70 A305	SPNC	GS2051-F0	-	○		
63		9	10	95 AU V142	T 20	24371047	-		○	

d [mm]	D [mm]	H [mm]	L [mm]	Material	Design	Part No.	PU ¹⁾	US	EU
53	65	6	7	94 AU 925	AUN 1	12297 40421112	IP SP		● ●
	65	10	11	90 NBR 109	N 1	16768	-		○
	66	7,3	7,5	19YF / A980	SPN	GS2307-V0	-	○	
	69	12	13	94 U801	IDI	FU0682-F0	-	○	
53,5	64,2	4	4,2	PTFE B602 / NBR	OMS-MR	49042171	-		○
53,98	64,68	4	4,2	PTFE B602 / NBR	OMS-MR	24307481	-		○
54	69,1	5,9	6,3	PTFE B602 / NBR	OMS-MR	24307503	-		○
	69,1	5,9	6,3	95 AU V142	SYPRIM SM	24370654 0536-370.654	-	○	○
	62,2	3,8	4	PTFE 177023	TFMI	98541	IP		●
	63	7,3	8	95 AU V142	T 20	24236859 40422318 8004-236.859	IP SP -	○	● ●
	63	8	9	94 AU 925	KI 310	309995 40421852	IP SP	○	● ●
	63	8	9	94 AU 925	NI 300	523147	-		○
	63	8	9	95 AU V142	T 20	24290846	-		○
	63	8,2	9	95 AU V142	T 20	24223292 40422248	IP SP		● ●
	63	10,9	12	95 AU V142	T 24	24309794	-		○
	64,4	6,6	7,1	PTFE F56110	FOI	379672	-		○
	65	5	6	90 NBR 109	N 1	16787 40421486	IP SP		● ●
	65	6	7	U641	ISI	FU0694-K2	-	○	
	65	6	7	U801	ISI	FU0694-K0	-	○	
	65	6	7	A505	IUH	CU0694-N3	-	○	
	65	6	7	A567	IUH	CU0694-N5	-	○	
	65	7	7,5	31BF / 70 A305	SPNC	GS2052-F0	-	○	
	65	7,1	8	92 AU 21100	HDR-2C	49311262	IP		●
	65	7,3	8	92 AU 21100	LF 300	49022143	-		○
	65	7,3	8	94 AU 30000	LF 300	49334410	-		○
55	65	7,3	8	94 AU 925	LF 300	521698 40422053	IP SP		● ●
	65	7,3	8	94 AU 30000	T 20	49334167	-		○
	65	7,3	8	95 AU V142	T 20	24239429 40422328	IP SP	○	● ●
	65	7,5	8	70 NBR B209	S 8	24027658	IP		●
	65	7,5	8,5	94 AU 925	KI 310	325922 40421891	IP SP		● ●
	65	8	9	94 U801	IDI	FU0696-F0	-	○	
	65	8	9	94 AU 925	NI 300	384050	-		○
	65	10	11	94 AU 925	KI 310	326238 40421897	IP SP		● ●
	65	10	11	94 AU 925	NI 300	21357 40421625	IP SP		● ●
	65	10	11	94 AU 30000	T 20	49334168	-		○
	65	10	11	95 AU V142	T 20	24187207 40422195	IP SP		● ●
	65	10	11	95 AU V142	T 22	24250839 40422357	IP SP		● ●
	65	11,4	13	95 AU V142	T 22	24250840	-		○
	65	11,8	13	95 AU V142	T 20	24187208 40422196	IP SP		● ●
	65	12	13	94 AU 925	KI 310	349885 40421924	IP SP		● ●

d [mm]	D [mm]	H [mm]	L [mm]	Material	Design	Part No.	PU ¹⁾	US	EU
55	65	12	13	94 AU 925	NI 300	21361 40421626	IP SP		● ●
	65,7	4	4,2	PTFE B602 / NBR	OMS-MR	24262488	IP		●
	65,7	4	4,2	PTFE B602 / FKM	OMS-MR	24344722	-		○
	65,7	4	4,2	PTFE GM201 / NBR	OMS-MR	24262485	-		○
	67	5,8		PTFE F52902	TFW	208	-		○
	67	8,7	9,6	95 AU V142	T 20	24374139	-		○
	67	10	10,6	70 NBR B209	S 8	24007510	IP		●
	67	10	11	95 AU V142	T 20	24261225	-		○
	68	6,5	7,5	90 NBR 109	N 1	16783 40421484	IP SP		● ●
	68	10	11	U801 / S813	UNI	FU1995-M1	-	○	
	70	7,5	8,5	90 NBR 109	N 1	16784 40421485	IP SP		● ●
	70	9	10	94 U801	IDI	FU0700-F0	-	○	
	70	10	11	94 U801	IDI	FU0701-F0	-	○	
	70	10	11	94 AU 925	NI 300	18766 40421589	IP SP		● ●
	70	10	11	95 AU V142	T 20	24238292 40422325	IP SP		● ●
	70	11,4	13	95 AU V142	T 20	24187209 40422197	IP SP		● ●
	70	11,4	13	95 AU V142	T 22	24250841 40422358	IP SP		● ●
	70	12	13	94 AU 925	AUN 100	14363 40421220	IP SP	○	● ●
	70	12	13	80 NBR 878	NI 250	18406	-	○	○
	70	12	13	94 AU 925	NI 300	21364 40421627	IP SP		● ●
	70	16,5	16,5	BHNBR B3B246	ES	24063126	IP		●
	70	16,5	16,5	BHFKM B3K674	ESV	24194608	-		○
	70	22,5	22,5	BHNBR B3B246	ES	24070191	IP		●
	70	22,5	22,5	BHFKM B3K674	ESV	24129136	-		○
	70,1	5,9	6,3	PTFE B602 / NBR	OMS-MR	24178445	IP		●
	70,1	5,9	6,3	PTFE B602 / FKM	OMS-MR	24245798	-		○
	70,1	5,9	6,3	PTFE GM201 / NBR	OMS-MR	24131212	IP		●
	70,1	5,9	6,3	PTFE B602 / NBR	OMS-MR PR	49023488	IP		●
	70,1	5,9	6,3	PTFE C104 / NBR	OMS-MR PR	49019333	-		○
	70,1	5,9	6,3	PTFE GM201 / NBR	OMS-MR PR	49014635	-		○
	70,5	6	6,3	U641 / 12NM	HBV	FQ0256-F5	-	○	
	70,5	6	6,3	U801 / 12NM	HBV	FQ0256-F4	-	○	
70,5	6	6,3	UH05 / 12NM	HBV	FQ0256-F7	-	○		
71	10	11	94 U801	IDI	FU0703-F0	-	○		
71	12	13	94 U801	IDI	FU0704-F0	-	○		
75	10	11	94 AU 925	AUN 1	14227 40421182	IP SP		● ●	
75	10	11	90 NBR 109	N 1	16778 40421483	IP SP		● ●	
75	12	13	94 AU 925	AUN 100	14364 40421221	IP SP		● ●	
75	12	13	94 U801	IDI	FU0708-F0	-	○		
75	12	13	90 NBR 109	N 100	17674 40421533	IP SP		● ●	
75	12	13	80 NBR 878	NI 250	18407	-		○	
75	12	13	94 AU 925	NI 300	21365	-		○	

d [mm]	D [mm]	H [mm]	L [mm]	Material	Design	Part No.	PU ¹⁾	US	EU
	75	12	13	80 NBR 878	NI 400	4459	-		○
	75	30	30	BHFKM B4K674	ESV	24139318	-		○
	75	45	45	MAI-PT C9T003	DMS	24293261	-		○
55	80	12	2,5	88 NBR 101	H MF	10277 40421066	IP SP		● ●
	80	12	13	90 NBR 109	N 1	16780	-		○
	80	15	16	90 NBR 109	N 100	17936	-		○
	85	15	16	90 NBR 109	N 1	16786	-		○
	90	15	4	88 NBR 101	H OF	10280	-		○
	63,2	3,8	4	PTFE 177023	TFMI	96707	-		○
	65,4	6,6	7,1	PTFE F56110	FOI	434452	IP		●
	66	6	7	U641	ISI	FU0722-K1	-	○	
	66	6	7	U801	ISI	FU0722-K0	-	○	
	66	6	7	A505	IUH	CU0722-N2	-	○	
	66	7	7,5	31BF / 70 A305	SPNC	GS2053-F0	-	○	
	66	7,3	8	94 AU 30000	T 20	49334169	-		○
	66	7,3	8	95 AU V142	T 20	24266874 40422379 8004-266.874	IP SP -	○	● ●
	66	7,5	8	70 NBR B209	S 8	24007513	IP		●
	66	8	9	94 U801	IDI	FU0723-F0	-	○	
	66	8,2	9	95 AU V142	T 20	24223293 40422249	IP SP		● ●
	66	10	11	94 AU 925	NI 300	21368 40421628	IP SP		● ●
	66	10	11	94 AU 30000	T 20	49334190	-		○
	66	10	11	95 AU V142	T 20	24236884 40422322	IP SP		● ●
	66,7	4	4,2	PTFE B602 / NBR	OMS-MR	24223159	IP		●
	66,7	4	4,2	PTFE B602 / FKM	OMS-MR	24244976	IP		●
	66,7	4	4,2	PTFE GM201 / NBR	OMS-MR	24131183	IP		●
56	68	8,5	9,5	80 NBR 878	NI 150	84548 40421787	IP SP		● ●
	68	10	11	95 AU V142	T 20	24367432	-		○
	71	6,3	6,5	19YF / A305	SPNO	GS2814-V0	-	○	
	71	7	7,5	PTFE GM201	OMS-S	24096131	-		○
	71	9	10	94 U801	IDI	FU0724-F0	-	○	
	71	10	11	94 U801	IDI	FU0725-F0	-	○	
	71	10	11	94 AU 925	NI 300	21374 40421629	IP SP		● ●
	71	10	11	80 NBR 878	NI 400	24600	-		○
	71	11,4	12,5	92 AU 21100	LF 300	49308208	IP		●
	71	11,4	12,5	94 AU 925	LF 300	521699 40422054	IP SP		● ●
	71	11,4	12,5	95 AU V142	T 20	24223294 40422250 8004-223.294	IP SP -	○	● ●
	71	11,4	12,5	95 AU V142	T 22	24250842 40422359	IP SP		● ●
	71	11,4	13	95 AU V142	T 20	24223295	-		○
	71	11,4	13	95 AU V142	T 22	24250843	-		○
	71	12	13	80 NBR 878	NI 250	18424	-		○
	71	12,5	12,5	94 AU 925	KI 320	351893	IP	○	●
	71	16,5	16,5	BH-NBR B3B246	ES	24112157	IP		●
	71	16,5	16,5	BHFKM B3K674	ESV	24149111	IP		●

d [mm]	D [mm]	H [mm]	L [mm]	Material	Design	Part No.	PU ¹⁾	US	EU
	71	22,5	22,5	BHNBR B3B246	ES	24070192	IP		●
	71	22,5	22,5	BHFKM B3K674	ESV	24139076	IP		●
	71	25	25	BHNBR B3B246	ES	24327283	IP		●
	71	25	25	BHFKM B3K674	ESV	24220004	-		○
	71,1	5,9	6,3	PTFE 55YF/70 A305	HBTS	GS5049V6	-	○	
	71,1	5,9	6,3	PTFE B602/NBR	OMS-MR	24178446	IP		●
	71,1	5,9	6,3	PTFE B602/FKM	OMS-MR	24265478	IP		●
	71,1	5,9	6,3	PTFE GM201/NBR	OMS-MR	24101265	IP		●
	71,1	5,9	6,3	PTFE B602/NBR	OMS-MR PR	49002594	IP		●
	71,1	5,9	6,3	PTFE C104/NBR	OMS-MR PR	49018474	-		○
56	71,1	5,9	6,3	PTFE GM201/NBR	OMS-MR PR	49014916	-		○
	71,1	5,9	6,3	95 AU V142	SYPRIM SM	24351367 0536-351.367	-	●	○
	72	10	11	94 U801	IDI	FU0726-F0	-	○	
	72	12	13	94 U801	IDI	FU0727-F0	-	○	
	76	12	13	94 U801	IDI	FU0728-F0	-	○	
	76	12	13	94 AU 925	NI 300	21379	-		○
	76	32	32	BHNBR B4B246	ES	24220054	-		○
	76	32	32	BHFKM B4K674	ESV	24220005	-		○
	76	37	37	BHFKM B4K674	ESV	24139131	-		○
	76	45	45	MAHPT C9T003	DMS	24293262	-		○
57	72,1	5,9	6,3	PTFE B602/NBR	OMS-MR	49001987	-		○
57,15	67,85	4	4,2	PTFE B602/NBR	OMS-MR	24307482	-		○
	72,25	6,3	6,3	PTFE B602/NBR	OMS-MR	24307504	-		○
58	68	7	7,5	31BF/70 A305	SPNC	GS2054-F0	-	○	
	68	7,3	8	92 AU 21100	LF 300	49024465	-		○
	68	7,3	8	94 AU 925	LF 300	522300	-		○
	68	10	11	94 AU 925	NI 300	472965	-		○
	68,7	4	4,2	PTFE B602/NBR	OMS-MR	24333843	-		○
	70	6	7	90 NBR 109	N 1	16806 40421487	IP SP		● ●
	73,1	5,9	6,3	PTFE B602/NBR	OMS-MR	24289230	-		○
	68	8	9	94 AU 925	AUN 1	12157	-		○
	68	8	9	94 AU 925	KI 310	310022 40421863	IP SP		● ●
	68	8	9	90 NBR 109	N 1	16820 40421489	IP SP		● ●
	68	8,2	9	94 AU 30000	T 20	49334191	-		○
	68	8,2	9	95 AU V142	T 20	24219456 40422210	IP SP		● ●
	68	10,4	12	95 AU V142	T 24	24306330	-		○
60	68	13	14	94 AU 925	KI 310	323085	-		○
	69,4	6,6	7,1	PTFE F56110	FOI	366357	IP		●
	70	6	7	U641	ISI	FU0746-K5	-	○	
	70	6	7	U801	ISI	FU0746-K0	-	○	
	70	6	7	A505	IUH	CU0746-N3	-	○	
	70	6	7	A567	IUH	CU0746-N6	-	○	
	70	7	7,5	31BF/70 A305	SPNC	GS2055-F0	-	○	
	70	7,3	8	92 AU 21100	HDR-2C	49305019	IP		●
	70	7,3	8	92 AU 21100	LF 300	49024502	-		○
	70	7,3	8	94 AU 30000	LF 300	49334411	-		○

d [mm]	D [mm]	H [mm]	L [mm]	Material	Design	Part No.	PU ¹⁾	US	EU	
60	70	7,3	8	94 AU 925	LF 300	524196 40422070	IP SP		● ●	
	70	7,3	8	94 AU 30000	T 20	49334193	-		○	
	70	7,3	8	95 AU V142	T 20	24236858 40422317	IP SP		● ●	
	70	7,5	8	70 NBR B209	S 8	24007520	IP		●	
	70	7,5	8,5	94 AU 925	KI 310	326236 40421896	IP SP		● ●	
	70	8	9	94 U801	IDI	FU0747-F0	-	○		
	70	10	11	94 AU 925	NI 300	18771 40421590	IP SP	○	● ●	
	70	10	11	94 AU 30000	T 20	49334194	-		○	
	70	10	11	95 AU V142	T 20	24223296 40422251	IP SP		● ●	
	70	10	11	95 AU V142	T 22	24250844 40422360	IP SP		● ●	
	70	11,4	13	95 AU V142	T 22	24250845	-		○	
	70	11,8	13	95 AU V142	T 20	24187211 40422198 8004-187.211	IP SP -		○	● ●
	70	12	13	94 AU 925	AUN 100	14411 40421242	IP SP		● ●	
	70	12	13	94 AU 30000	NI 300	49334497	-		○	
	70	12	13	94 AU 925	NI 300	21386 40421630	IP SP		● ●	
	70,7	4	4,2	PTFE B602 / NBR	OMS-MR	24223162	IP		●	
	70,7	4	4,2	PTFE B602 / FKM	OMS-MR	24250623	-		○	
	70,7	4	4,2	PTFE C104 / NBR	OMS-MR	49069400	-		○	
	70,7	4	4,2	PTFE GM201 / NBR	OMS-MR	24131184	-		○	
	70,7	4	4,2	PTFE GM201 / FKM	OMS-MR	24355469	-		○	
	72	6	7	94 AU 925	AUN 1	14448	-		○	
	72	8,5	9,5	80 NBR 878	NI 150	84549 40421788	IP SP		● ●	
	72	10	11	95 AU V142	T 20	24261224	-		○	
	72	11,4	13	93 AU V167	TM 23	24301853	-		○	
	72,2	7,3	7,5	PTFE 177023	TFMI	98375	IP		●	
	73	7,3	7,5	19YF / A980	SPN	GS2308-V0	-	○		
	73	10	11	U801 / S813	UNI	FU2097-M1	-	○		
	74	7	8	90 NBR 109	N 1	16828 40421490	IP SP		● ●	
	75	6,3	6,5	19YF / A305	SPNO	GS2815-V0	-	○		
	75	7	7,5	PTFE GM201	OMS-S	24096132	IP		●	
	75	9	10	94 U801	IDI	FU0753-F0	-	○		
	75	10	11	92 AU 21100	HDR-2C	49065883	-		○	
	75	10	11	94 U801	IDI	FU0754-F0	-	○		
	75	10	11	94 AU 925	NI 300	21391 40421631	IP SP		● ●	
	75	10	11	80 NBR 878	NI 400	3612	IP		●	
	75	10,4	11	95 AU V142	T 20	24337823	-		○	
	75	11,4	12,5	92 AU 21100	LF 300	49308209	-		○	
	75	11,4	12,5	94 AU 925	LF 300	521700 40422055	IP SP		● ●	
	75	11,4	12,5	95 AU V142	T 20	24223297 40422252	IP SP	○	● ●	
	75	11,4	12,5	95 AU V142	T 22	24250846	-		○	
	75	11,4	12,5	95 AU V142	T 23	24302157	IP	○	●	

d [mm]	D [mm]	H [mm]	L [mm]	Material	Design	Part No.	PU ¹⁾	US	EU
60	75	11,4	13	94 AU 30000	T 20	49334195	-		○
	75	11,4	13	95 AU V142	T 20	24187212 40422199	IP SP		● ●
	75	11,4	13	95 AU V142	T 22	24250847 40422361 8048-250.847	IP SP -	○	● ●
	75	11,5	12,5	94 AU 925	NI 300	531745	-		○
	75	12	13	94 AU 925	AUN 100	14365 40421222	IP SP		● ●
	75	12	13	80 NBR 878	NI 250	18408	-		○
	75	12	13	94 AU 925	NI 300	21395 40421632	IP SP		● ●
	75	16,5	16,5	BHNBR B3B246	ES	24062181	IP		●
	75	16,5	16,5	BHFKM B3K674	ESV	24194385	-		○
	75	22,5	22,5	BHNBR B3B246	ES	24070193	IP		●
	75	22,5	22,5	BHFKM B3K674	ESV	24148038	IP		●
	75,1	5,9	6,3	PTFE 55YF/70 A305	HBTS	GS5051-V6	-	○	
	75,1	5,9	6,3	PTFE B602/NBR	OMS-MR	24178447	IP		●
	75,1	5,9	6,3	PTFE B602/FKM	OMS-MR	24288710	IP		●
	75,1	5,9	6,3	PTFE GM201/NBR	OMS-MR	24105984	IP		●
	75,1	5,9	6,3	PTFE GM201/FKM	OMS-MR	49035035	-		○
	75,1	5,9	6,3	PTFE B602/NBR	OMS-MR PR	49039570	IP		●
	75,1	5,9	6,3	PTFE GM201/NBR	OMS-MR PR	49012253	IP		●
	75,1	5,9	6,3	95 AU V142	SYPRIM SM	24352073	IP	○	●
	75,5	6	6,3	U641/12NM	HBV	FQ0257-F5	-	○	
	75,5	6	6,3	U801/12NM	HBV	FQ0257-F4	-	○	
	75,5	6	6,3	UH05/12NM	HBV	FQ0257-F6	-	○	
	76	10	11	94 U801	IDI	FU0756-F0	-	○	
	76	12	13	94 U801	IDI	FU0757-F0	-	○	
	80	9,3		PTFE F52902	TFW	34245	IP	○	●
	80	10	11	94 AU 925	AUN 1	14450 40421246	IP SP		● ●
	80	10	11	90 NBR 109	N 1	16818 40421488	IP SP		● ●
	80	12	13	94 AU 925	AUN 100	34397 40421744	IP SP		● ●
	80	12	13	94 U801	IDI	FU0761-F0	-	○	
	80	12	13	90 NBR 109	N 100	16850 40421491	IP SP		● ●
	80	12	13	80 NBR 878	NI 250	18409	-		○
	80	12	13	94 AU 925	NI 300	18772 40421591	IP SP	○	● ●
	80	12	13	80 NBR 878	NI 400	30007	-		○
80	14,6	16	93 AU V167	TMP 20	24377711	-		○	
80	16,6	18,2	95 AU V142	T 20	24373695	-		○	
80	18	19	94 AU 925	AUN 1	14454 40421247	IP SP		● ●	
80	37	37	BHFKM B4K674	ESV	24103349	-		○	
80	45	45	MAHPT C9T003	DMS	24293263	-		○	
84	12	13	90 NBR 109	N 1	16827	-		○	
85	12	3	88 NBR 101	H MF	10295 40421067	IP SP		● ●	
85	12	13	90 NBR 109	N 1	16825	-		○	
85	12,5	13,5	94 AU 925	AUN 1	14453	-		○	
85	15	16	90 NBR 109	N 100	17937	-		○	

d [mm]	D [mm]	H [mm]	L [mm]	Material	Design	Part No.	PU ¹⁾	US	EU
60	90	12	3	88 NBR 101	H OF	10297 40421068	IP SP		● ●
	90	13	3	88 NBR 101	H MF	10301	-		○
	90	15	16	90 NBR 109	N 1	16831	-		○
61	73	6	7	90 NBR 109	N 1	16852	-		○
62	72	7	7,5	31BF/70 A305	SPNC	GS2056F0	-	○	
	72,7	4	4,2	PTFE B602/NBR	OMS-MR	24360764	-		○
	77,1	5,9	6,3	PTFE GM201/NBR	OMS-MR	49024836	-		○
	78	8	9	90 NBR 109	N 1	16858	-		○
	82	10	11	90 NBR 109	N 1	16855	-		○
62,5	73,2	4	4,2	PTFE B602/NBR	OMS-MR	49023395	-		○
63	71	8	9	94 AU 925	KI 310	325758 40421879	IP SP		● ●
	72,4	6,6	7,1	PTFE F56110	FOI	366358	-		○
	72,4	6,6	7,1	PTFE F56110	FOI	433995	-		○
	73	6	7	U641	ISI	FU0786-K3	-	○	
	73	6	7	U801	ISI	FU0786-K0	-	○	
	73	6	7	A505	IUH	CU0786-N2	-	○	
	73	7	7,5	31BF/70 A305	SPNC	GS2057F0	-	○	
	73	7,3	8	92 AU 21100	IF 300	49024501	-		○
	73	8	9	94 U801	IDI	FU0787-F0	-	○	
	73	11,8	13	95 AU V142	T 20	24223298 40422253	IP SP		● ●
	73	12	13	94 AU 30000	NI 300	49334498	-		○
	73	12	13	94 AU 925	NI 300	21396 40421633	IP SP		● ●
	73,7	4	4,2	PTFE B602/NBR	OMS-MR	49001988	-		○
	75	8,5	9,5	80 NBR 878	NI 150	84550 40421789	IP SP		● ●
	75	8,7	9,6	95 AU V142	T 20	24246801 40422342 8004-246.801	IP SP -	○	● ● ●
	75	9	9,5	70 NBR B209	S 8	24007539	IP		●
	75,2	7,3	7,5	PTFE 177023	TFMI	38664	-	○	○
	78	6,3	6,5	19YF/A305	SPNO	GS2816-V0	-	○	
	78	7	7,5	PTFE GM201	OMS-S	24096133	-		○
	78	9	10	94 U801	IDI	FU0788-F0	-	○	
	78	10	11	94 U801	IDI	FU0789-F0	-	○	
	78	10	11	94 AU 925	NI 300	21406 40421634	IP SP		● ●
	78	10	11	80 NBR 878	NI 400	24619	-		○
	78	10	11	95 AU V142	T 20	24236586	-		○
	78	11,4	12,5	94 AU 30000	IF 300	49334412	-		○
	78	11,4	12,5	94 AU 925	IF 300	521701 40422056	IP SP		● ●
	78	11,4	12,5	94 AU 30000	T 20	49334196	-		○
78	11,4	12,5	95 AU V142	T 20	24223299 40422254 8004-223.299	IP SP -	○	● ● ●	
78	12	13	80 NBR 878	NI 250	18425	IP		●	
78	12,5	12,5	94 AU 925	KI 320	351894	IP	○	●	
78	16,5	16,5	BHNBR B3B246	ES	24114075	-		○	
78	16,5	16,5	BIFKM B3K674	ESV	24220006	-		○	
78	22,5	22,5	BHNBR B3B246	ES	24070194	IP		●	

d [mm]	D [mm]	H [mm]	L [mm]	Material	Design	Part No.	PU ¹⁾	US	EU
	78	22,5	22,5	BHFKM B3K674	ESV	24148039	-		○
	78	25	25	BHNBR B3B246	ES	24327282	-		○
	78	25	25	BHFKM B3K674	ESV	24220007	-		○
	78,1	5,9	6,3	PTFE 55YF/70 A305	HBTS	GS5052-V6	-	○	
	78,1	5,9	6,3	PTFE B602/NBR	OMS-MR	24190727	IP		●
	78,1	5,9	6,3	PTFE B602/FKM	OMS-MR	24245797	-		○
	78,1	5,9	6,3	PTFE C104/NBR	OMS-MR	49038138	-		○
	78,1	5,9	6,3	PTFE GM201/NBR	OMS-MR	24131213	IP		●
	78,1	5,9	6,3	PTFE GM201/FKM	OMS-MR	49005461	-		○
	78,1	5,9	6,3	PTFE B602/NBR	OMS-MR PR	49009142	-		○
	78,1	5,9	6,3	PTFE C104/NBR	OMS-MR PR	49018475	-		○
	78,1	5,9	6,3	PTFE GM201/NBR	OMS-MR PR	49014917	IP		●
	78,1	5,9	6,3	95 AU V142	SYPRIM SM	24356949 0536-356.949	IP -	●	●
63	79	10	11	94 U801	IDI	FU0790-F0	-	○	
	79	12	13	94 U801	IDI	FU0791-F0	-	○	
	80	12,7	14	95 AU V142	T 20	24370282	-		○
	83	11,4	12,5	95 AU V142	T 22	24289913	-		○
	83	11,4	13	95 AU V142	T 22	24291789	-		○
	83	12	13	94 U801	IDI	FU0793-F0	-	○	
	83	12	13	94 AU 925	NI 300	21407 40421635	IP SP		● ●
	83	12	13	80 NBR 878	NI 400	24624	-		○
	83	14,6	16	95 AU V142	T 20	24289375	-		○
	83	15	16	94 AU 925	AUN 100	13532	-		○
	83	15	16	90 NBR 109	N 100	938 40421001	IP SP		● ●
	83	32	32	BHNBR B4B246	ES	24220056	-		○
	83	32	32	BHFKM B4K674	ESV	24220008	-		○
	93	15	16	90 NBR 109	N 1	16865	-		○
63,5	74,2	4,2	4,2	PTFE B602/NBR	OMS-MR	24307484	-		○
	78,6	5,9	6,3	PTFE GM201/NBR	OMS-MR	24307638	-		○
	78,6	6,3	6,3	PTFE B602/NBR	OMS-MR	24307506	-		○
	72	8	9	94 AU 925	KI 310	326233	-		○
	79,1	5,9	6,3	PTFE B602/NBR	OMS-MR	24356043	-		○
64	80	8	9	90 NBR 109	N 1	16870 40421492	IP SP		● ●
	80	12	13	94 U801	IDI	FU2131-F0	-	○	
	73	8	9	94 AU 925	KI 310	326232 40421895	IP SP	○	● ●
	73	8,2	9	95 AU V142	T 20	49000807	-		○
	73	10,9	12	95 AU V142	T 24	24314232	-		○
	73	11,5	12,5	94 AU 925	KI 310	310024	-		○
	74,4	6,6	7,1	PTFE F56110	FOI	382322	-		○
65	75	6	7	U641	ISI	FU0809-K1	-	○	
	75	6	7	U801	ISI	FU0809-K0	-	○	
	75	6	7	A505	IUH	CU0809-N2	-	○	
	75	6	7	A567	IUH	CU0809-N4	-	○	
	75	7	7,5	31BF/70 A305	SPNC	GS2058-F0	-	○	
	75	7,3	8	92 AU 21100	LF 300	49308210	-		○
	75	7,3	8	94 AU 925	LF 300	529093 40422076	IP SP		● ●

d [mm]	D [mm]	H [mm]	L [mm]	Material	Design	Part No.	PU ¹⁾	US	EU
	75	7,3	8	95 AU V142	T 20	24370874	-		○
	75	7,5	8	70 NBR B209	S 8	24142200	IP		●
	75	8	9	94 U801	IDI	FU0810-F0	-	○	
	75	11,4	13	95 AU V142	T 22	24250848	IP		●
	75	11,8	13	95 AU V142	T 20	24187213 40422200	IP SP		● ●
	75	12	13	94 AU 925	AUN 100	14407 40421241	IP SP		● ●
	75	12	13	94 AU 925	KI 310	326231 40421894	IP SP		● ●
	75	12	13	94 AU 925	NI 300	21420 40421636	IP SP		● ●
	77	8,7	9,6	95 AU V142	T 20	24251887 40422370	IP SP		● ●
	77	9	9,5	70 NBR B209	S 8	24007545	IP		●
	77	9	10	94 AU 925	KI 310	325759	-		○
	77,2	7,3	7,5	PTFE 177023	TFMI	98772	-		○
	78	7,3	7,5	19YF/A980	SPN	GS2309-V0	-	○	
	78	10	11	A505	IUH	529958	-	○	
	78	10	11	U801/S813	UNI	FU2074-M1	-	○	
	80	7	7,5	PTFE GM201	OMS-S	24096134	-		○
	80	7,5	8,5	90 NBR 109	N 1	16882 40421493	IP SP		● ●
	80	9	10	94 U801	IDI	FU0815-F0	-	○	
	80	9	10	G928	IUH	CU3615-N0	-	○	
	80	10	11	95 AU V142	T 20	24373620	-		○
	80	11	12	94 AU 925	AUN 1	14240	-		○
65	80	11,4	13	94 AU 30000	T 20	49334197	-		○
	80	11,4	13	95 AU V142	T 20	24223300 40422255 8004-223.300	IP SP -	○	● ●
	80	11,4	13	95 AU V142	T 22	24250849	-		○
	80	12	13	94 AU 925	AUN 100	14366 40421223	IP SP	○	● ●
	80	12	13	94 U801	IDI	FU0816-F0	-	○	
	80	12	13	80 NBR 878	NI 250	18411	IP		●
	80	12	13	94 AU 925	NI 300	21429 40421637	IP SP		● ●
	80	13	13	94 AU 925	KI 320	351895	IP		●
	80	16,5	16,5	BH-NBR B3B246	ES	24062183	-		○
	80	16,5	16,5	BH-FKM B3K674	ESV	24220009	-		○
	80	22,5	22,5	BH-NBR B3B246	ES	24070195	IP		●
	80	22,5	22,5	BH-FKM B3K674	ESV	24139077	-		○
	80,1	5,9	6,3	PTFE 55YF/70 A305	HBTS	GS5053-V6	-	○	
	80,1	5,9	6,3	PTFE B602/NBR	OMS-MR	24178449	IP		●
	80,1	5,9	6,3	PTFE B602/FKM	OMS-MR	24344723	-		○
	80,1	5,9	6,3	PTFE GM201/NBR	OMS-MR	24131214	IP		●
	80,1	5,9	6,3	PTFE GM201/FKM	OMS-MR	24329275	-		○
	80,1	5,9	6,3	PTFE B602/NBR	OMS-MR PR	49002595	-		○
	80,1	5,9	6,3	PTFE C104/NBR	OMS-MR PR	49021364	-		○
	80,5	6	6,3	U641/12NM	HBV	FG0258-F3	-	○	
	80,5	6	6,3	U801/12NM	HBV	FG0258-F4	-	○	
	80,5	6	6,3	UH05/12NM	HBV	FG0258-F7	-	○	
	85	9,3		PTFE F52902	TFW	12462	-		○

d [mm]	D [mm]	H [mm]	L [mm]	Material	Design	Part No.	PU ¹⁾	US	EU
65	85	10	11	94 AU 925	AUN 1	14251 40421183	IP SP		● ●
	85	10	11	90 NBR 109	N 1	16880	-		○
	85	11,4	13	95 AU V142	T 22	24250850	-		○
	85	11,8	13	95 AU V142	T 20	24223301	-		○
	85	12	13	94 AU 925	AUN 100	14297 40421191	IP SP		● ●
	85	12	13	94 U801	IDI	FU0819F0	-	○	
	85	12	13	85 NBR B203	L 20	24096771	-		○
	85	12	13	90 NBR 109	N 100	17667 40421532	IP SP		● ●
	85	12	13	94 AU 925	NI 300	18773 40421592	IP SP		● ●
	85	12	13	80 NBR 878	NI 400	4479	-		○
	85	45	45	MAHPT C9T003	DMS	24293265	-		○
	90	11,2		PTFE F52902	TFW	110662	IP		●
	90	12	4	88 NBR 101	H OF	10320	-		○
	90	12	13	90 NBR 109	N 1	16879	-		○
	95	13	3	88 NBR 101	H MF	10322	-		○
105	12	3	88 NBR 101	H MF	10319 40421069	IP SP		● ●	
66	76	10	11	90 NBR 109	N 1	16887	-		○
66,68	77,38	4,2	4,2	PTFE B602/NBR	OMS-MR	24307485	-		○
67	77	6	7	U641	ISI	FU0828-K1	-	○	
	77	6	7	U801	ISI	FU0828-K0	-	○	
	77	6	7	A505	IUH	CU0828-N0	-	○	
	77	7	7,5	31BF/70 A305	SPNC	GS2059-F0	-	○	
	82	9	10	94 U801	IDI	FU0830-F0	-	○	
	82,1	5,9	6,3	PTFE 55YF/70 A305	HBTS	GS5054-V6	-	○	
	87	15	16	94 U801	IDI	FU0832-F0	-	○	
68	78	7,3	8	92 AU 21100	IF 300	49024493	-		○
	78	7,3	8	94 AU 925	IF 300	530059	-		○
	78	10	11	90 NBR 109	N 1	16896	-		○
	78	12	13	94 AU 925	NI 300	380798	-		○
	80	6	7	94 AU 925	AUN 1	14461 40421248	IP SP		● ●
	80	12	13	90 NBR 109	N 1	16893 40421494	IP SP		● ●
	83,1	5,9	6,3	PTFE B602/NBR	OMS-MR	24359517	-		○
	83,1	5,9	6,3	PTFE GM201/NBR	OMS-MR PR	49024835	-		○
69	79,7	4	4,2	PTFE C104/NBR	OMS-MR	49033470	-		○
69,85	80,55	4,2	4,2	PTFE B602/NBR	OMS-MR	24307486	-		○
70	78	8	9	94 AU 925	KI 310	325923 40421892	IP SP		● ●
	78	8,2	9	95 AU V142	T 20	24314731 40422456	IP SP		● ●
	78	10,9	12	95 AU V142	T 24	24308889	-		○
	79,4	6,6	7,1	PTFE F56110	FOI	366359	IP		●
	79,6	7,9	8,7	95 AU V142	T 20	24373899	-		○
	80	6	7	U641	ISI	FU0849-K5	-	○	
	80	6	7	U801	ISI	FU0849-K0	-	○	
	80	6	7	G928	IUH	CU0849-N2	-	○	
	80	6	9,5	A505	IUH	CU0849-N0	-	○	
80	7	7,5	70 NBR B209	S 8	24084356	IP		●	

d [mm]	D [mm]	H [mm]	L [mm]	Material	Design	Part No.	PU ¹⁾	US	EU
	80	7	7,5	31BF/70 A305	SPNC	GS2060-F0	-	○	
	80	7,1	8	92 AU 21100	HDR-2C	49311263	IP		●
	80	7,3	8	92 AU 21100	LF 300	49024492	-		○
	80	7,3	8	94 AU 30000	LF 300	49334413	-		○
	80	7,3	8	94 AU 925	LF 300	530778 40422083	IP SP		● ●
	80	8	9	94 U801	IDI	FU0850-F0	-	○	
	80	11,4	13	95 AU V142	T 22	24250851 40422362	IP SP		● ●
	80	11,8	13	95 AU V142	T 20	24187214 40422201	IP SP		● ●
	80	12	13	94 AU 925	AUN 100	14431 40421245	IP SP		● ●
	80	12	13	94 AU 30000	NI 300	49334499	-		○
	80	12	13	94 AU 925	NI 300	21430 40421638	IP SP		● ●
	80,7	4	4,2	PTFE B602/NBR	OMS-MR	24334160	-		○
	80,7	4	4,2	PTFE C104/NBR	OMS-MR PR	49011113	-		○
	82	5,8		PTFE F52902	TFW	39330	-		○
	82	8,5	9,5	80 NBR 878	NI 150	84551 40421790	IP SP		● ●
	82	8,7	9,6	94 AU 30000	T 20	49334198	-		○
	82	8,7	9,6	95 AU V142	T 20	24236857 40422316 568004-236.857	IP SP -	○	● ●
	82	9	9,5	70 NBR B209	S 8	24007555	IP		●
	82	9	10	94 AU 925	KI 310	325760 40421880	IP SP		● ●
70	82	12	13	90 NBR 109	N 1	16905	-		○
	82,2	7,3	7,5	PTFE 177023	TFMI	98377	-		○
	83	7,3	7,5	19YF/A980	SPN	GS2310-V0	-	○	
	83	10	11	U801/S813	UNI	FU2088-M1	-	○	
	85	6,3	6,5	19YF/A305	SPNO	GS2817-V0	-	○	
	85	7	7,5	PTFE GM201	OMS-S	24096135	IP		●
	85	7,5	8,5	90 NBR 109	N 1	16902 40421496	IP SP		● ●
	85	9	10	94 U801	IDI	FU0857-F0	-	○	
	85	9	10	A505	IUH	CU0857-N2	-	○	
	85	9	10	A567	IUH	CU0857-N3	-	○	
	85	9	10	G928	IUH	CU0857-N4	-	○	
	85	10	11	94 U801	IDI	FU0858-F0	-	○	
	85	10	11	94 AU 925	NI 300	18776 40421593	IP SP		● ●
	85	10	11	80 NBR 878	NI 400	24632	IP		●
	85	10	11	95 AU V142	T 20	24233880 40422312	IP SP		● ●
	85	11,4	12,5	92 AU 21100	LF 300	49044882	-		○
	85	11,4	12,5	94 AU 925	LF 300	521702 40422057	IP SP		● ●
	85	11,4	12,5	94 AU 30000	T 20	49334199	-		○
	85	11,4	12,5	95 AU V142	T 20	24212669 40422207 8004-212.669	IP SP -	●	● ●
	85	11,4	12,5	95 AU V142	T 23	24295613	IP		●
	85	11,4	13	95 AU V142	T 20	24223302 40422256	IP SP	○	● ●
	85	11,4	13	95 AU V157	TM 23	24296870	-		○

d [mm]	D [mm]	H [mm]	L [mm]	Material	Design	Part No.	PU ¹⁾	US	EU
70	85	11,5	12,2	70 NBR B209	S 8	24007558	IP		●
	85	11,5	12,5	94 AU 925	NI 300	319968	IP		●
	85	12	13	94 AU 925	AUN 100	14367 40421224	IP SP		● ●
	85	12	13	80 NBR 878	NI 250	18413	IP		●
	85	12	13	94 AU 925	NI 300	21438 40421639	IP SP		● ●
	85	12,5	12,5	94 AU 925	KI 320	351896	IP	○	●
	85	16,5	16,5	BHNBR B3B246	ES	24062188	IP		●
	85	16,5	16,5	BHFKM B3K674	ESV	24144001	-		○
	85	22,5	22,5	BHNBR B3B246	ES	24070196	IP		●
	85	22,5	22,5	BHFKM B3K674	ESV	24138992	IP		●
	85	25	25	BHNBR B3B246	ES	24327280	IP		●
	85	25	25	BHFKM B3K674	ESV	24220010	-		○
	85,1	5,9	6,3	PTFE 55YF / 70 A305	HBTS	G55055-V6	-	○	
	85,1	5,9	6,3	PTFE B602 / NBR	OMS-MR	24178450	IP		●
	85,1	5,9	6,3	PTFE B602 / FKM	OMS-MR	24245800	-		○
	85,1	5,9	6,3	PTFE GM201 / NBR	OMS-MR	24110738	IP		●
	85,1	5,9	6,3	PTFE GM201 / FKM	OMS-MR	24377431	IP		●
	85,1	5,9	6,3	PTFE B602 / NBR	OMS-MR PR	49006087	IP		●
	85,1	5,9	6,3	PTFE C104 / NBR	OMS-MR PR	49017738	-		○
	85,1	5,9	6,3	PTFE GM201 / NBR	OMS-MR PR	49008472	IP		●
	85,1	5,9	6,3	95 AU V142	SYPRIM SM	24345981 0536-345.981	IP -	●	●
	85,5	6	6,3	U641 / 12NM	HBV	FG0244-F4	-	○	
	85,5	6	6,3	U801 / 12NM	HBV	FG0244-F5	-	○	
	85,5	6	6,3	UH05 / 12NM	HBV	FG0244-F8	-	○	
	86	14	15,5	95 AU V142	T 20	24363001	-		○
	90	10	2,5	88 NBR 101	H OF	10335 40421071	IP SP		● ●
	90	10	11	90 NBR 109	N 1	16899 40421495	IP SP		● ●
	90	11,4	13	95 AU V142	T 20	24223304 40422257	IP SP		● ●
	90	11,4	13	95 AU V142	T 22	24250854	-		○
	90	12	13	94 AU 925	AUN 100	14322 40421198	IP SP		● ●
	90	12	13	94 U801	IDI	FU0862-F0	-	○	
	90	12	13	85 NBR B203	L 20	24094874	-		○
	90	12	13	90 NBR 109	N 100	17863 40421554	IP SP		● ●
	90	12	13	94 AU 925	NI 300	18777 40421594	IP SP		● ●
	90	12	13	80 NBR 878	NI 400	24633	-		○
	90	14,6	16	95 AU V142	T 20	24223303	-		○
	90	14,6	16	95 AU V142	T 22	24250855 40422363	IP SP		● ●
	90	15	16	94 U801	IDI	FU0864-F0	-	○	
	90	18	19	94 AU 925	AUN 1	14465 40421249	IP SP		● ●
	90	32	32	BHNBR B4B246	ES	24220058	IP		●
	90	32	32	BHFKM B4K674	ESV	24220011	-		○
	90	40	40	BHFKM B4K674	ESV	24104730	-		○
90	45	45	MAHPT C9T003	DMS	24293266	-		○	

d [mm]	D [mm]	H [mm]	L [mm]	Material	Design	Part No.	PU ¹⁾	US	EU
70	95	12	13	94 AU 925	AUN 1	14466	-		○
	95	12	13	90 NBR 109	N 1	16900	-		○
	95	15	16	90 NBR 109	N 100	17938	-		○
	98	12	3	88 NBR 101	H MF	10332 40421070	IP SP		● ●
	100	15	16	90 NBR 109	N 1	16901	-		○
	110	13	3	88 NBR 101	H MF	10333	-		○
71	79	8	9	94 AU 925	KI 310	310023	-		○
	80	6	7	A505	IUH	CU0879-N0	-	○	
	81	6	7	U641	ISI	FU0880-K1	-	○	
	81	6	7	U801	ISI	FU0880-K0	-	○	
	81	7	7,5	31BF/70 A305	SPNC	GS2061-F0	-	○	
	81	8	9	94 U801	IDI	FU0881-F0	-	○	
	86	9	10	94 U801	IDI	FU0882-F0	-	○	
	86	10	11	94 U801	IDI	FU0883-F0	-	○	
	86,1	5,9	6,3	PTFE 55YF/70 A305	HBTS	GS5056-V6	-	○	
	91	12	13	94 U801	IDI	FU0884-F0	-	○	
91	15	16	94 U801	IDI	FU0885-F0	-	○		
72	84	6	7	90 NBR 109	N 1	16922 40421497	IP SP		● ●
	84	8,7	9,6	95 AU V142	T 20	24362391	-		○
	92	14,6	16	95 AU V142	T 20	24358384	-		○
73	80	8	9	94 AU 925	KI 310	326249	-		○
	85	8,7	9,6	95 AU V142	T 20	24374940	-		○
	85	11,4	12,5	95 AU V142	T 20	24363261	-		○
	88,1	5,9	6,3	PTFE C104/NBR	OMS-MR PR	49039585	-		○
73,03	83,73	4,2	4,2	PTFE B602/NBR	OMS-MR	24307487	-		○
	88,13	6,3	6,3	PTFE B602/NBR	OMS-MR	24307509	-		○
74	80	8	9	90 NBR 109	N 1	16932	-		○
	89,1	5,9	6,3	PTFE C104/NBR	OMS-MR PR	49023807	-		○
75	83	8	9	94 AU 925	KI 310	326584 40421906	IP SP		● ●
	83	10,9	12	95 AU V142	T 24	24302750 40422414	IP SP		● ●
	85	6	7	U641	ISI	FU0901-K1	-	○	
	85	6	7	U801	ISI	FU0901-K0	-	○	
	85	6	7	A505	IUH	CU0901-N4	-	○	
	85	6	7	A567	IUH	CU0901-N6	-	○	
	85	7	7,5	31BF/70 A305	SPNC	GS2062-F0	-	○	
	85	8	9	94 U801	IDI	FU0903-F0	-	○	
	85	11,4	12,5	95 AU V142	T 22	24265555	-		○
	85	11,4	13	95 AU V142	T 22	24265557	-		○
	85	12	12,5	95 AU V142	T 20	24227939 40422311	IP SP		● ●
	85	12	13	94 AU 925	AUN 100	12185 40421107	IP SP	○	● ●
	85	12	13	94 AU 30000	NI 300	49334500	-		○
	85	12	13	94 AU 925	NI 300	21440 40421640	IP SP		● ●
	87	8,7	9,6	94 AU 30000	T 20	49334200	-		○
	87	8,7	9,6	95 AU V142	T 20	24266875 40422380 8004-266.875	IP SP -	○	● ●
	87	9	9,5	70 NBR B209	S 8	24007567	IP		●

d [mm]	D [mm]	H [mm]	L [mm]	Material	Design	Part No.	PU ¹⁾	US	EU
75	87	9	10	94 AU 925	KI 310	325761 40421881	IP SP		● ●
	87,2	7,3	7,5	PTFE 177023	TFMI	98773	-		○
	88	7,3	7,5	19YF/A980	SPN	GS2311-V0	-	○	
	88	10	11	A505	IUH	529957	-	○	
	88	10	11	95 AU V142	T 20	24374792	-		○
	88	10	11	U801/S813	UNI	FU2227-M1	-	○	
	90	6,3	6,5	19YF/A305	SPNO	GS2818-V0	-	○	
	90	7,5	8,5	94 AU 925	AUN 1	12182 40421106	IP SP		● ●
	90	7,5	8,5	90 NBR 109	N 1	17431 40421524	IP SP		● ●
	90	9	9,9	95 AU V142	T 20	24374761	-		○
	90	9	10	94 U801	IDI	FU0906-F0	-	○	
	90	9	10	A505	IUH	CU3090-N2	-	○	
	90	9	10	G928	IUH	CU3090-N4	-	○	
	90	10	11	94 U801	IDI	FU0907-F0	-	○	
	90	10	11	94 AU 925	NI 300	21446 40421641	IP SP		● ●
	90	10	11	80 NBR 878	NI 400	30946	-		○
	90	10	11	94 AU 30000	T 20	49334201	-		○
	90	10	11	95 AU V142	T 20	24223305 40422258	IP SP		● ●
	90	10	11	95 AU V142	T 22	24250856	-		○
	90	12	13	94 AU 925	AUN 100	14368 40421225	IP SP		● ●
	90	12	13	94 AU 925	NI 300	18779 40421595	IP SP	○	● ●
	90	13	13	94 AU 925	KI 320	351897	IP	○	●
	90	16,5	16,5	BHNBR B3B246	ES	24061639	-		○
	90	16,5	16,5	BHFKM B3K674	ESV	24220012	-		○
	90	22,5	22,5	BHNBR B3B246	ES	24070197	IP		●
	90	22,5	22,5	BHFKM B3K674	ESV	24148040	-		○
	90,1	5,9	6,3	PTFE 55YF/70 A305	HBTS	GS5057-V6	-	○	
	90,1	5,9	6,3	PTFE B602/NBR	OMS-MR	24178451	IP		●
	90,1	5,9	6,3	PTFE B602/FKM	OMS-MR	24263440	-		○
	90,1	5,9	6,3	PTFE GM201/NBR	OMS-MR	24121487	IP		●
	90,1	5,9	6,3	PTFE GM201/FKM	OMS-MR	24245341	-		○
	90,1	5,9	6,3	PTFE B602/NBR	OMS-MR PR	49002596	-		○
	90,1	5,9	6,3	PTFE C104/NBR	OMS-MR PR	49018476	-		○
	90,1	5,9	6,3	PTFE GM201/NBR	OMS-MR PR	49022320	IP		●
	90,5	6	6,3	U641/12NM	HBV	FQ0245-F4	-	○	
	90,5	6	6,3	U801/12NM	HBV	FQ0245-F5	-	○	
	90,5	6	6,3	UH05/12NM	HBV	FQ0245-F8	-	○	
	95	9,4	10	PTFE GM201	OMS-S	24096136	-		○
	95	10	11	90 NBR 109	N 1	16935 40421498	IP SP		● ●
	95	12	13	94 AU 925	AUN 100	14478 40421250	IP SP		● ●
	95	12	13	94 U801	IDI	FU0910-F0	-	○	
	95	12	13	85 NBR B247	L 20	24096772	-		○
95	12	13	90 NBR 109	N 100	18067 40421577	IP SP		● ●	
95	14,6	16	95 AU V142	T 20	24370708	IP	○	●	

d [mm]	D [mm]	H [mm]	L [mm]	Material	Design	Part No.	PU ¹⁾	US	EU
	95	15	16	94 U801	IDI	FU0911-F0	-	○	
	95	45	45	MAHPT C9T003	DMS	24293267	-		○
75	100	12	13	90 NBR 109	N 1	16936	-		○
	100	15	16	90 NBR 109	N 1	16934	-		○
	100	15	16	90 NBR 109	N 100	16943	-		○
	105	15	16	90 NBR 109	N 1	16939	-		○
	115	12	2,5	88 NBR 101	H MF	10345 40421072	IP SP		● ●
76,2	86,9	4,2	4,2	PTFE B602 / NBR	OMS-MR	24307488	-		○
	91,3	5,9	6,3	PTFE B602 / NBR	OMS-MR	24307510	-		○
76,5	87,2	4	4,2	PTFE GM201 / FKM	OMS-MR	24376290	-		○
77	87	7,3	8	92 AU 21100	LF 300	49024459	-		○
	87	7,3	8	94 AU 925	LF 300	530060	-		○
	87	12	13	94 AU 925	NI 300	369026	-	○	○
	92,1	5,9	6,3	PTFE GM201 / NBR	OMS-MR	528708	-		○
78	86	8	9	94 AU 925	KI 310	310025 40421864	IP SP		● ●
	86	8	9	90 NBR 109	N 1	16950 40421499	IP SP		● ●
	90	12	12,5	70 NBR B209	S 8	24068016	IP		●
	93,1	5,9	6,3	PTFE B602 / NBR	OMS-MR	24345481	-		○
	102	12	13	90 NBR 109	N 1	16951	-		○
	106	12	3,5	88 NBR 101	H MF	10352	-		○
80	10	12	13	94 U801	IDI	FU0948-F0	-	○	
	10	15	16	94 U801	IDI	FU0949-F0	-	○	
	88	8	9	94 AU 925	KI 310	325924 40421893	IP SP	○	● ●
	88	10,9	12	95 AU V142	T 24	24306333 40422417	IP SP		● ●
	89,4	6,6	7,1	PTFE F56110	FOI	366360	IP		●
	90	6	7	U641	ISI	FU0939-K1	-	○	
	90	6	7	U801	ISI	FU0939-K0	-	○	
	90	6	7	A505	IUH	CU0939-N3	-	○	
	90	6	7	A567	IUH	CU0939-N4	-	○	
	90	7	7,5	31BF / 70 A305	SPNC	GS2063-F0	-	○	
	90	7,3	8	92 AU 21100	LF 300	49308213	-		○
	90	7,3	8	94 AU 30000	LF 300	49334414	-		○
	90	7,3	8	94 AU 925	LF 300	530062 40422081	IP SP		● ●
	90	7,3	8	95 AU V142	T 20	24363199	-		○
	90	8	9	94 U801	IDI	FU0940-F0	-	○	
	90	10	11	94 AU 925	AUN 100	12197 40421108	IP SP		● ●
	90	10	11	94 AU 925	KI 310	349890 40421925	IP SP		● ●
	90	10	11	94 AU 925	NI 300	127310	-		○
	90	10	11	95 AU V142	T 20	24187219	-		○
	90	11,4	13	95 AU V142	T 22	24250857	-		○
90	11,8	13	95 AU V142	T 20	24223306 40422259	IP SP		● ●	
90	12	13	94 AU 30000	NI 300	49334501	-		○	
90	12	13	94 AU 925	NI 300	21447 40421642	IP SP		● ●	
90,7	4	4,2	PTFE B602 / NBR	OMS-MR	24334161	IP		●	

d [mm]	D [mm]	H [mm]	L [mm]	Material	Design	Part No.	PU ¹⁾	US	EU
80	92	8,5	9,5	80 NBR 878	NI 150	84552 40421791	IP SP		● ●
	92	8,7	9,6	94 AU 30000	T 20	49334202	-		○
	92	8,7	9,6	95 AU V142	T 20	24241622 40422329 8004-241.622	IP SP -	○	● ●
	92	9	9,5	70 NBR B209	S 8	24027655	IP		●
	92	9	10	94 AU 925	KI 310	325762 40421882	IP SP		● ●
	92	10,9	12	93 AU V167	TM 23	24301858	-		○
	92,2	7,3	7,5	PTFE 177023	TFMI	98724	-		○
	93	7,3	7,5	19YF/A980	SPN	GS2312-V0	-	○	
	93	8	9	90 NBR 109	N 1	16964	-		○
	93	10	11	A505	IUH	529956	-	○	
	93	10	11	U801/S813	UNI	FU2107-M1	-	○	
	95	6,3	6,5	19YF/A305	SPNO	GS2819-V0	-	○	
	95	7,5	8,5	90 NBR 109	N 1	16965	-		○
	95	9	9,9	95 AU V142	T 20	24374809	-		○
	95	9	10	94 U801	IDI	FU0942-F0	-	○	
	95	9	10	A505	IUH	CU3091-N2	-	○	
	95	9	10	G928	IUH	CU3091-N4	-	○	
	95	10	11	94 U801	IDI	FU0943-F0	-	○	
	95	10	11	94 AU 925	NI 300	21454 40421643	IP SP		● ●
	95	10	11	80 NBR 878	NI 400	24638	IP		●
	95	10	11	95 AU V142	T 20	24373621	-		○
	95	11,3	12,5	92 AU 21100	HDR-2C	49305020	IP		●
	95	11,4	12,5	92 AU 21100	LF 300	49024458	-		○
	95	11,4	12,5	94 AU 925	LF 300	521703	IP		●
	95	11,4	12,5	95 AU V142	T 20	24223307 40422260 8004-223.307	IP SP -	○	● ●
	95	11,4	12,5	95 AU V142	T 22	24250858 40422364	IP SP		● ●
	95	11,4	12,5	95 AU V142	T 23	24302158	IP		●
	95	11,4	13	94 AU 30000	T 20	49334203	-		○
	95	11,4	13	95 AU V142	T 20	24187220 40422202	IP SP		● ●
	95	11,4	13	95 AU V142	T 22	24250859	-		○
	95	12	12,5	70 NBR B209	S 8	24143115	IP		●
	95	12	13	94 AU 925	AUN 100	14369 40421226	IP SP		● ●
95	12	13	94 AU 925	NI 300	21455 40421644	IP SP		● ●	
95	12,5	12,5	94 AU 925	KI 320	351898	IP	○	●	
95	14,6	16	95 AU V157	TM 23	24309920	-		○	
95	16,5	16,5	BHNBR B3B246	ES	24062194	IP		●	
95	16,5	16,5	BHFKM B3K674	ESV	24149110	-		○	
95	22,5	22,5	BHNBR B3B246	ES	24070198	IP		●	
95	22,5	22,5	BHFKM B3K674	ESV	24139078	IP		●	
95	25	25	BHNBR B3B246	ES	24060905	-		○	
95	25	25	BHFKM B3K674	ESV	24220013	-		○	
95,1	5,9	6,3	PTFE 55YF/70 A305	HBTS	GS5058-V6	-	○		
95,1	5,9	6,3	PTFE B602/NBR	OMS-MR	24178452	IP		●	

d [mm]	D [mm]	H [mm]	L [mm]	Material	Design	Part No.	PU ¹⁾	US	EU
	95,1	5,9	6,3	PTFE B602 / FKM	OMS-MR	24275322	IP		●
	95,1	5,9	6,3	PTFE C104 / NBR	OMS-MR	49039867	-		○
	95,1	5,9	6,3	PTFE GM201 / NBR	OMS-MR	24121483	IP		●
	95,1	5,9	6,3	PTFE B602 / NBR	OMS-MR PR	49005181	IP		●
	95,1	5,9	6,3	PTFE C104 / NBR	OMS-MR PR	49039522	-		○
	95,1	5,9	6,3	PTFE GM201 / FKM	OMS-MR PR	49013961	-		○
	95,1	5,9	6,3	PTFE GM201 / NBR	OMS-MR PR	49016403	IP		●
	95,1	5,9	6,3	95 AU V142	SYPRIM SM	24355289 0536-355.289	IP -	●	●
	95,5	6	6,3	U641 / 12NM	HBV	FG0246F5	-	○	
	95,5	6	6,3	U801 / 12NM	HBV	FG0246F6	-	○	
	95,5	6	6,3	UH05 / 12NM	HBV	FG0246F9	-	○	
	100	9,4	10	PTFE GM201	OMS-S	24096137	-		○
	100	9,4	10	PTFE GM201	OMS-S PR	49016726	-		○
	100	10	11	94 AU 925	AUN 1	14482 40421251	IP SP		● ●
	100	10	11	90 NBR 109	N 1	17367 40421522	IP SP		● ●
	100	11,4	13	95 AU V142	T 20	24223308 40422261 8004-223.308	IP SP -	○	● ●
	100	11,4	13	95 AU V142	T 22	24250860 8048-250.860	- -	○	○
	100	12	13	94 AU 925	AUN 100	14271 40421187	IP SP		● ●
80	100	12	13	85 NBR B203	L 20	24094875	-		○
	100	12	13	90 NBR 109	N 100	16974 40421500	IP SP	○	● ●
	100	12	13	94 AU 925	NI 300	18781 40421596	IP SP	○	● ●
	100	12	13	80 NBR 878	NI 400	24647	IP		●
	100	14,6	16	95 AU V142	T 20	24223309 40422262	IP SP	○	● ●
	100	14,6	16	93 AU V167	TMP 20	24370305	-		○
	100	15	16	90 NBR 109	N 100	17636 40421528	IP SP		● ●
	100	15	16	80 NBR 878	NI 250	5285	IP		●
	100	15	16	94 AU 925	NI 300	337358	-		○
	100	32	32	BI-NBR B4B246	ES	24220060	IP		●
	100	32	32	BI-FKM B4K674	ESV	24220014	-		○
	100	40	40	BI-FKM B4K674	ESV	24104763	-		○
	100	45	45	MAI-PT C9T003	DMS	24293268	-		○
	105	12	13	90 NBR 109	N 1	16963	-		○
	105	15	16	90 NBR 109	N 100	17939	-		○
	105	15	16	80 NBR 878	NI 400	24648	-		○
	108	15	4	88 NBR 101	H OF	10355	-		○
	110	15	16	94 AU 925	AUN 1	14483	-		○
	110	15	16	90 NBR 109	N 1	16960	-		○
	115	15	16	90 NBR 109	N 1	16961	-		○
	120	15	3	88 NBR 101	H MF	10356	-		○
80,5	95,6	5,9	6,3	PTFE GM201 / FKM	OMS-MR	49015769	-		○
	89	8	9	94 AU 925	KI 310	310026 40421865	IP SP		● ●
81	96,1	5,9	6,3	PTFE B602 / NBR	OMS-MR	24369226	-		○
	96,1	5,9	6,3	PTFE GM201 / NBR	OMS-MR	24369639	-		○

d [mm]	D [mm]	H [mm]	L [mm]	Material	Design	Part No.	PU ¹⁾	US	EU	
82	97,1	5,9	6,3	PTFE B602 / NBR	OMS-MR	24333838	-		○	
	100	9	10	90 NBR 109	N 1	16977	-		○	
82,55	97,65	5,9	6,3	PTFE B602 / NBR	OMS-MR	24307512	-		○	
	97,65	5,9	6,3	PTFE GM201 / NBR	OMS-MR	24307644	-		○	
82,6	101,6	15,2	16,7	95 AU V142	T 20	24296094	-		○	
83	98,1	5,9	6,3	PTFE B602 / NBR	OMS-MR	49002024	-		○	
	10	6,3	6,5	19YF / A305	SPNO	GS2820-V0	-	○		
	10	9	10	U641	ISI	FU0984-K2	-	○		
	10	9	10	U801	ISI	FU0984-K0	-	○		
	10	9	10	A505	IUH	CU0984-N1	-	○		
	10	9	10	G928	IUH	CU0984-N3	-	○		
	10	10	11	94 U801	IDI	FU0985-F0	-	○		
	93	6,5	7,5	94 AU 925	KI 310	329399	-		○	
	94	15	16	94 AU 925	KI 310	326251	-		○	
	95	7	7,5	31BF / 70 A305	SPNC	GS2064-F0	-	○		
	95	11,8	12,5	95 AU V142	T 20	24213882 40422208	IP SP		● ●	
	95	12	13	94 AU 925	NI 300	432307	-		○	
	97	8,7	9,6	94 AU 30000	T 20	49334204	-		○	
	97	8,7	9,6	95 AU V142	T 20	24266876 40422381	IP SP		● ●	
	97	9	9,5	70 NBR B209	S 8	24007587	IP		●	
	97	9	10	94 AU 925	KI 310	325763	-		○	
	97,2	7,3	7,5	PTFE 177023	TFMI	98774	-		○	
	100	7,5	8,5	90 NBR 109	N 1	16993 40421502	IP SP		● ●	
	100	9	9,9	95 AU V142	T 20	24374873	-		○	
	100	10	11	95 AU V142	T 20	24374762	-		○	
	100	11,3	12	70 NBR B209	S 8	24007590	IP		●	
	100	11,4	12,5	92 AU 21100	LF 300	49024457	-		○	
	100	11,4	12,5	94 AU 925	LF 300	530064	-		○	
	100	11,4	12,5	95 AU V142	T 20	24223310 40422263 8004-223.310	IP SP -		○	● ●
	100	11,4	13	94 AU 30000	T 20	49334205	-		○	
	100	11,4	13	95 AU V142	T 20	24194923 40422205 8004-194.923	IP SP -		○	● ●
	100	11,4	13	93 AU V167	TM 23	24359397	-		○	
	100	12	13	94 AU 925	AUN 100	12109 40421104	IP SP		● ●	
	100	12	13	94 AU 925	NI 300	21466 40421645	IP SP		● ●	
	100	13	13	94 AU 925	KI 320	351899	IP	○	●	
	100	16,5	16,5	BHNBR B3B246	ES	24078907	-		○	
	100	16,5	16,5	BHFKM B3K674	ESV	24194607	-		○	
	100	22,5	22,5	BHNBR B3B246	ES	24070199	IP		●	
100	22,5	22,5	BHFKM B3K674	ESV	24106403	-		○		
100,1	5,9	6,3	PTFE 55YF / 70 A305	HBTS	GS5059-V6	-	○			
100,1	5,9	6,3	PTFE B602 / NBR	OMS-MR	24178453	IP		●		
100,1	5,9	6,3	PTFE B602 / FKM	OMS-MR	24329122	-		○		
100,1	5,9	6,3	PTFE GM201 / NBR	OMS-MR	24110740	IP		●		
100,1	5,9	6,3	PTFE B602 / NBR	OMS-MR PR	49002597	-		○		
100,1	5,9	6,3	PTFE C104 / NBR	OMS-MR PR	49018477	-		○		

d [mm]	D [mm]	H [mm]	L [mm]	Material	Design	Part No.	PU ¹⁾	US	EU
	100,1	5,9	6,3	PTFE GM201 / NBR	OMS-MR PR	49018521	-		○
	100,1	5,9	6,3	95 AU V142	SYPRIM SM	24341751 0536-341.751	-	●	○
	100,5	6	6,3	U641 / 12NM	HBY	FQ0259-F6	-	○	
	100,5	6	6,3	U801 / 12NM	HBY	FQ0259-F5	-	○	
	100,5	6	6,3	UH05 / 12NM	HBY	FQ1226-F0	-	○	
	105	9,3		PTFE F52902	TFW	37457	-		○
	105	9,4	10	PTFE GM201	OMS-S	24096138	-		○
	105	10	3	88 NBR 101	H MF	10367	-		○
	105	10	11	90 NBR 109	N 1	16989 40421501	IP SP		● ●
	105	12	13	94 AU 925	AUN 100	14341 40421201	IP SP		● ●
85	105	12	13	94 U801	IDI	FU0989-F0	-	○	
	105	12	13	G928	IUH	CU0989-N0	-	○	
	105	12	13	85 NBR B247	L 20	24096773	-		○
	105	12	13	90 NBR 109	N 1	16988	-		○
	105	15	16	94 U801	IDI	FU0990-F0	-	○	
	105	15	16	90 NBR 109	N 100	18019 40421571	IP SP		● ●
	105	15	16	U801 / S813	UNI	FU0990-M1	-	○	
	105	18	19	94 AU 925	AUN 1	14296	-		○
	105	45	45	MAI-PT C9T003	DMS	24293269	-		○
	110	12	13	90 NBR 109	N 1	16990	-	○	○
	110	15	16	90 NBR 109	N 100	16997	-		○
	115	15	16	90 NBR 109	N 1	16991	-		○
86	98	12	13	90 NBR 109	N 1	11675	-		○
87	95	8	9	94 AU 925	KI 310	310027 40421866	IP SP		● ●
	100	6	7	90 NBR 109	N 1	16999 40421503	IP SP		● ●
88	103,1	5,9	6,3	PTFE B602 / NBR	OMS-MR	532498	-		○
	105	12,7	14	95 AU V142	T 20	24360733	-		○
	104	5,9	6,3	PTFE B602 / NBR	OMS-MR	24290835	-		○
88,9	104	5,9	6,3	PTFE B602 / FKM	OMS-MR	24359949	-		○
	107,95	14,4	15,9	95 AU V142	T 20	24362624	-		○
	10	7	7,5	31BF / 70 A305	SPNC	GS2065-F0	-	○	
	98	5,7	6,3	95 AU V142	T 20	24293541	-		○
	98	8	9	94 AU 925	KI 310	325764 40421883	IP SP		● ●
	98	8,2	9	95 AU V142	T 20	24359373	-		○
	98	10,9	12	95 AU V142	T 24	24302751 40422415	IP SP		● ●
	99,4	6,6	7,1	PTFE F56110	FOI	386511	IP		●
90	99,4	6,6	7,1	PTFE20 F55102	FOI	162680	-		○
	99,6	7,6	8,4	95 AU V142	T 20	24375705	-		○
	100	6,8	7,5	95 AU V142	T 20	24368410	-		○
	100	10	11	95 AU V142	T 20	24209770	-		○
	100	12	13	94 AU 925	NI 300	29310	-		○
	100	15	16	95 AU V142	NRS-0503	24257838	-		○
	102	8,5	9,5	80 NBR 878	NI 150	84553 40421792	IP SP		● ●
	102	8,7	9,6	94 AU 30000	T 20	49334206	-		○

d [mm]	D [mm]	H [mm]	L [mm]	Material	Design	Part No.	PU ¹⁾	US	EU
90	102	8,7	9,6	95 AU V142	T 20	24251888 40422371 8004-251.888	IP SP -	○	● ●
	102	9	9,5	70 NBR B209	S 8	24007602	IP		●
	102	9	10	94 AU 925	KI 310	325765 40421884	IP SP		● ●
	102,2	7,3	7,5	PTFE 177023	TFMI	98775	-		○
	103,4	7,3	7,5	19YF/A980	SPN	GS2313-V0	-	○	
	105	6,3	6,5	19YF/A305	SPNO	GS2821-V0	-	○	
	105	7,5	8,5	90 NBR 109	N 1	17009 40421505	IP SP		● ●
	105	9	10	U641	ISI	FU1024-K3	-	○	
	105	9	10	U801	ISI	FU1024-K0	-	○	
	105	9	10	A505	IUH	CU1024-N3	-	○	
	105	9	10	A567	IUH	CU1024-N5	-	○	
	105	10	11	94 U801	IDI	FU1025-F2	-	○	
	105	10	11	95 AU V142	T 20	24235803	IP		●
	105	11,3	12	70 NBR B209	S 8	24007605	IP		●
	105	11,4	12,5	92 AU 21100	LF 300	49308214	IP		●
	105	11,4	12,5	94 AU 30000	LF 300	49334415	-		○
	105	11,4	12,5	94 AU 925	LF 300	521705 40422058	IP SP		● ●
	105	11,4	12,5	94 AU 30000	T 20	49334207	-		○
	105	11,4	12,5	95 AU V142	T 20	24223311 40422264 351-2177	IP SP -	○	● ●
	105	11,4	12,5	95 AU V142	T 22	24250861 40422365	IP SP		● ●
	105	11,4	13	95 AU V142	T 20	24223312 40422265 8004-223.312	IP SP -	○	● ●
	105	11,4	13	95 AU V142	T 22	24250862	-		○
	105	11,5	12,5	92 AU 21100	HDR-2C	49311260	IP		●
	105	11,5	12,5	94 AU 925	NI 300	344874	-		○
	105	12	13	94 AU 925	AUN 100	14370 40421227	IP SP		● ●
	105	12	13	94 AU 30000	NI 300	49334502	-		○
	105	12	13	94 AU 925	NI 300	21474 40421646	IP SP		● ●
	105	22,5	22,5	BIFKM B3K674	ESV	24138991	IP		●
	105	25	25	BIFKM B3K674	ESV	24220015	-		○
	105,1	5,9	6,3	PTFE 55YF/70 A305	HBTS	GS5060-V6	-	○	
	105,1	5,9	6,3	PTFE B602/NBR	OMS-MR	24178454	IP		●
	105,1	5,9	6,3	PTFE B602/NBR	OMS-MR	24294068	-		○
	105,1	5,9	6,3	PTFE B602/FKM	OMS-MR	24334402	IP		●
	105,1	5,9	6,3	PTFE C104/NBR	OMS-MR	49038787	-		○
	105,1	5,9	6,3	PTFE GM201/NBR	OMS-MR	24111803	IP		●
	105,1	5,9	6,3	PTFE GM201/FKM	OMS-MR	24224544	-		○
	105,1	5,9	6,3	PTFE B602/NBR	OMS-MR PR	49027501	IP		●
	105,1	5,9	6,3	PTFE C104/NBR	OMS-MR PR	49017739	-		○
	105,1	5,9	6,3	PTFE GM201/NBR	OMS-MR PR	49040406	-		○
	105,1	5,9	6,3	95 AU V142	SYPRIM SM	24359197 0530-359.197	IP -	○	●
	105,5	6	6,3	U641/12NM	HBY	FQ0260-F5	-	○	
	105,5	6	6,3	U801/12NM	HBY	FQ0260-F6	-	○	

d [mm]	D [mm]	H [mm]	L [mm]	Material	Design	Part No.	PU ¹⁾	US	EU
	105,5	6	6,3	UH05 / 12NM	HBV	FG0260F9	-	○	
	110	9,4	10	PTFE GM201	OMS-S	24096139	-		○
	110	10	11	90 NBR 109	N 1	17007 40421504	IP SP		● ●
	110	11,4	13	95 AU V142	T 20	24223313 40422266	IP SP		● ●
	110	11,4	13	95 AU V142	T 22	24250863	-		○
	110	12	13	94 AU 925	AUN 100	14371 40421228	IP SP	○	● ●
	110	12	13	94 U801	IDI	FU1030-F1	-	○	
	110	12	13	G928	IUH	CU1030-N0	-	○	
	110	12	13	85 NBR B247	L 20	24096774	-		○
	110	12	13	94 AU 925	NI 300	18786 40421597	IP SP		● ●
	110	12	13	80 NBR 878	NI 400	24651	IP		●
	110	14,6	16	95 AU V142	T 20	24289376 40422397	IP SP		● ●
	110	14,6	16	95 AU V142	T 23	24265875	IP		●
	110	14,6	16	93 AU V167	TMP 20	24370306	-		○
	110	15	16	94 U801	IDI	FU1031-F0	-	○	
90	110	15	16	90 NBR 109	N 100	17856 40421552	IP SP		● ●
	110	15	16	80 NBR 878	NI 250	31860	-		○
	110	15	16	U801 / S813	UNI	FU1031-M1	-	○	
	110	18	19	94 AU 925	AUN 1	14500	-		○
	110	30	30	BHNBR B4B246	ES	24062197	IP		●
	110	30	30	BHFKM B4K674	ESV	24194606	-		○
	110	32	32	BHNBR B4B246	ES	24220061	IP		●
	110	32	32	BHFKM B4K674	ESV	24220016	-		○
	110	40	40	BHNBR B4B246	ES	24070231	IP		●
	110	40	40	BHFKM B4K674	ESV	24119600	IP		●
	110	45	45	MAHPT C9T003	DMS	24293270	-		○
	115	12	13	90 NBR 109	N 1	17008	-		○
	115	15	16	90 NBR 109	N 100	17011 40421506	IP SP		● ●
	115	15	16	80 NBR 878	NI 400	24655	-		○
	120	13,5	3,5	88 NBR 101	H MF	10374 40421073 1037451	IP SP -	○	● ●
	120	15	16	94 AU 925	AUN 1	14501 40421252	IP SP		● ●
	120	15	16	90 NBR 109	N 1	17005	-		○
	120	18	19	90 NBR 109	N 100	17940	-		○
91,5	106,6	6,15	6,3	PTFE B602 / NBR	OMS-MR	24350154	-		○
92	100	10,9	12	95 AU V142	T 24	24315416 40422457	IP SP		● ●
	107	11,4	12,5	92 AU 21100	LF 300	49024455	-		○
92,08	107,18	6,3	6,3	PTFE B602 / NBR	OMS-MR	24307514	-		○
93	101	10,9	12	95 AU V142	T 24	24308890	-		○
94	109,1	5,9	6,3	PTFE GM201 / NBR	OMS-MR	24375344	-		○
	103	10,9	12	95 AU V142	T 24	24314233	-		○
95	105	7	7,5	31BF / 70 A305	SPNC	GS2066-F0	-	○	
	107	12	12,5	70 NBR B209	S 8	24070580	IP		●
	107,2	7,3	7,5	PTFE 177023	TFMI	98058	-		○

d [mm]	D [mm]	H [mm]	L [mm]	Material	Design	Part No.	PU ¹⁾	US	EU
	110	6,3	6,5	19YF/A305	SPNO	GS2822-V0	-	○	
	110	7,5	8,5	90 NBR 109	N 1	17021	-		○
	110	9	9,9	95 AU V142	T 20	24374785	-		○
	110	9	10	U641	ISI	FU1051-K2	-	○	
	110	9	10	U801	ISI	FU1051-K0	-	○	
	110	9	10	A505	IUH	CU1051-N2	-	○	
	110	9	10	A567	IUH	CU1051-N5	-	○	
	110	9	10	G928	IUH	CU1051-N7	-	○	
	110	10	11	94 U801	IDI	FU1052-F0	-	○	
	110	10	11	95 AU V142	T 20	24374810	-		○
	110	11,8	13	95 AU V142	T 20	24369674	-		○
	110	12	13	94 AU 925	AUN 100	14372 40421229	IP SP	○	● ●
	110	12	13	94 AU 925	NI 300	335953	-		○
	110	13	13	94 AU 925	KI 320	351900	IP	○	●
	110	15	16	94 AU 925	AUN 1	12122	-		○
	110,1	5,9	6,3	PTFE 55YF/70 A305	HBTS	GS5061-V6	-	○	
	110,1	5,9	6,3	PTFE B602/FKM	OMS-MR	528679	-		○
	110,1	5,9	6,3	PTFE B602/NBR	OMS-MR	24213071	IP		●
95	110,1	5,9	6,3	PTFE GM201/NBR	OMS-MR	24223698	-		○
	110,1	5,9	6,3	PTFE C104/NBR	OMS-MR PR	49021365	-		○
	110,1	5,9	6,3	PTFE GM201/NBR	OMS-MR PR	49023416	-		○
	110,5	6	6,3	U641/12NM	HBV	FQ0575-F4	-	○	
	110,5	6	6,3	U801/12NM	HBV	FQ0575-F6	-	○	
	110,5	6	6,3	UH05/12NM	HBV	FQ1225-F0	-	○	
	115	10	11	90 NBR 109	N 1	17019	-		○
	115	11,4	13	95 AU V142	T 20	24265228 568004-265.228	-	●	○
	115	12	13	94 AU 925	AUN 100	14425 40421244	IP SP		● ●
	115	12	13	94 U801	IDI	FU1056-F0	-	○	
	115	12	13	G928	IUH	CU1056-N0	-	○	
	115	12	13	94 AU 925	NI 300	324248 40421874	IP SP		● ●
	115	12	13,2	95 AU V142	T 20	24374811	-		○
	115	15	16	94 U801	IDI	FU1057-F0	-	○	
	115	15	16	90 NBR 109	N 100	17909 40421557	IP SP		● ●
	115	18	19	94 AU 925	AUN 1	14253	-		○
	120	12	13	90 NBR 109	N 1	17020	-		○
	120	15	16	90 NBR 109	N 100	17832	-		○
97	105	8	9	94 AU 925	KI 310	310028 40421867	IP SP		● ●
	105	13	14	94 AU 925	KI 310	326228	-		○
98,43	113,53	5,9	6,3	PTFE GM201/NBR	OMS-MR	24307649	-		○
	108	8	9	94 AU 925	KI 310	325766 40421885	IP SP		● ●
	108	10,9	12	95 AU V142	T 24	24269499 40422388	IP SP		● ●
100	109,4	6,6	7,1	PTFE F56110	FOI	366361	IP		●
	110	5	6	90 NBR 109	N 1	17034 40421509	IP SP		● ●
	110	7	7,5	31BF/70 A305	SPNC	GS2067-F0	-	○	
	110	7,5	8	70 NBR B209	S 8	24176851	IP		●

d [mm]	D [mm]	H [mm]	L [mm]	Material	Design	Part No.	PU ¹⁾	US	EU
	112,2	7,3	7,5	PTFE TF6404	TFMI	99066	-		○
	113,4	7,3	7,5	19YF/A980	SPN	GS2314-V0	-	○	
	115	6,3	6,5	19YF/A305	SPNO	GS2823-V0	-	○	
	115	9	9,9	95 AU V142	T 20	24374763	-		○
	115	9	10	U641	ISI	FU1082-K1	-	○	
	115	9	10	U801	ISI	FU1082-K0	-	○	
	115	9	10	A505	IUH	CU1082-N3	-	○	
	115	9	10	A567	IUH	CU1082-N5	-	○	
	115	9	10	G928	IUH	CU1082-N7	-	○	
	115	10	11	94 U801	IDI	FU1083-F0	-	○	
	115	10	11	80 NBR 878	NI 150	84554 40421793	IP SP		● ●
	115	10	11	95 AU V142	T 20	24235802 40422315	IP SP		● ●
	115	10,9	12	95 AU V142	T 20	24266877 40422382	IP SP		● ●
	115	11,3	12	70 NBR B209	S 8	24027657	IP		●
	115	11,4	12,5	94 AU 30000	LF 300	49334416	-		○
	115	11,4	12,5	95 AU V142	LF 300	49063607	IP		●
	115	11,4	13	94 AU 30000	T 20	49334208	-		○
	115	11,4	13	95 AU V142	T 20	24223314 40422267	IP SP		● ●
	115	11,4	13	95 AU V142	T 22	24250864 40422366	IP SP		● ●
	115	12	13	94 AU 925	AUN 100	14373 40421230 1437344	IP SP -	○	● ●
100	115	12	13	94 AU 30000	NI 300	49334503	-		○
	115	12	13	94 AU 925	NI 300	21482 40421647	IP SP		● ●
	115	14,6	16	95 AU V142	T 23	24377482	-		○
	115	30	30	BHFKM B3K674	ESV	24099496	IP		●
	115,1	5,9	6,3	PTFE 55YF/70 A305	HBTS	GS5062-V6	-	○	
	115,1	5,9	6,3	PTFE B602/NBR	OMS-MR	24178455	IP		●
	115,1	5,9	6,3	PTFE B602/FKM	OMS-MR	24314801	IP		●
	115,1	5,9	6,3	PTFE B602/EPDM	OMS-MR	24363256	-		○
	115,1	5,9	6,3	PTFE C104/NBR	OMS-MR	49026668	-		○
	115,1	5,9	6,3	PTFE GM201/NBR	OMS-MR	24131215	IP		●
	115,1	5,9	6,3	PTFE GM201/FKM	OMS-MR	24327757	-		○
	115,1	5,9	6,3	PTFE B602/NBR	OMS-MR PR	49015915	IP		●
	115,1	5,9	6,3	PTFE C104/NBR	OMS-MR PR	49021366	IP		●
	115,1	5,9	6,3	PTFE GM201/NBR	OMS-MR PR	49020572	IP		●
	115,1	5,9	6,3	95 AU V142	SYPRIM SM	24332507 0536-332.507	IP -	○	●
	115,5	6	6,3	U641/12NM	HBY	FQ0261-F5	-	○	
	115,5	6	6,3	U801/12NM	HBY	FQ0261-F7	-	○	
	115,5	6	6,3	UH05/12NM	HBY	FQ1214-F1	-	○	
	120	9,4	10	PTFE GM201	OMS-S	24096140	-		○
	120	9,4	10	PTFE GM201	OMS-S	24369231	-		○
	120	9,4	10	PTFE B602	OMS-S PR	531594	-		○
	120	10	11	90 NBR 109	N 1	17032 40421508	IP SP		● ●
	120	11,4	12,5	95 AU V142	T 22	24250865 40422367	IP SP		● ●

d [mm]	D [mm]	H [mm]	L [mm]	Material	Design	Part No.	PU ¹⁾	US	EU
100	120	11,4	13	94 AU 30000	T 20	49334209	-		○
	120	11,4	13	95 AU V142	T 20	24223316 40422268 8004-223.316	IP SP -	○	● ●
	120	11,4	13	95 AU V142	T 22	24250866	-		○
	120	12	13	94 AU 925	AUN 100	14286 40421189	IP SP	○	● ●
	120	12	13	94 U801	IDI	FU1089-F0	-	○	
	120	12	13	A505	IUH	CU1089-N1	-	○	
	120	12	13	G928	IUH	CU1089-N2	-	○	
	120	12	13	94 AU 925	NI 300	18789 40421598	IP SP	○	● ●
	120	12	13	80 NBR 878	NI 400	24670	IP		●
	120	12	13,2	95 AU V142	T 20	24374793	-		○
	120	14,6	16	95 AU V142	T 20	24187222 40422203	IP SP		● ●
	120	14,6	16	95 AU V142	T 22	24250867	-		○
	120	14,6	16	95 AU V142	T 23	24302127	IP		●
	120	14,6	16	93 AU V167	TMP 20	24370307	-		○
	120	15	16	94 U801	IDI	FU1091-F0	-	○	
	120	15	16	90 NBR 109	N 100	17697 40421535	IP SP	○	● ●
	120	15	16	94 AU 925	NI 300	21483 40421648	IP SP		● ●
	120	15	16	U801 / S813	UNI	FU1091-M1	-	○	
	120	16	16	94 AU 925	KI 320	351901	IP	○	●
	120	30	30	BHNBR B4B246	ES	24062201	IP		●
	120	30	30	BHFKM B4K674	ESV	24220017	-		○
	120	32	32	BHNBR B4B246	ES	24126541	IP		●
	120	32	32	BHFKM B4K674	ESV	24220018	-		○
	120	39	40	BHNBR B4B246	ES	24132386	-		○
	120	40	40	BHFKM B4K674	ESV	24104764	IP		●
	120	45	45	MAI-PT C9T003	DMS	24293271	-		○
	124	10	4	88 NBR 101	H OF	10388	-		○
	125	11,2		PTFE F52902	TFW	99462	-		○
	125	12	13	94 AU 925	AUN 1	14513	-		○
	125	12	13	90 NBR 109	N 1	17031 40421507	IP SP		● ●
	125	15	16	85 NBR B247	L 20	24094876	-		○
	125	15	16	90 NBR 109	N 100	17716 40421537	IP SP		● ●
	125	15	16	94 AU 925	NI 300	401873	-		○
	125	15	16	80 NBR 878	NI 400	24721	-		○
	125	40	40	BHNBR B4B246	ES	24220062	IP		●
	125	40	40	BHFKM B4K674	ESV	24220019	-		○
	125	88	88	BHNBR B5B210	V 1000	24083925	-		○
	125	110	110	BHNBR B5B210	V 1000	24071835	-		○
	125	110	110	BHNR B5A151	V 1000	24230657	-		○
	130	13	3	88 NBR 101	H MF	10390 40421074	IP SP		● ●
130	15	16	94 AU 925	AUN 1	14514	-		○	
130	15	16	90 NBR 109	N 1	11687	-		○	
130	18	19	90 NBR 109	N 100	17825	-		○	
130	93,5	93,5	BHNBR B5B210	V 1000	24071247	-		○	

d [mm]	D [mm]	H [mm]	L [mm]	Material	Design	Part No.	PU ¹⁾	US	EU
100	130	100	100	BHNBR B5B210	V 1000	24089315	-		○
	130	120	120	BHNBR B5B210	V 1000	24085541	-		○
	130	120	120	BHNR B5A151	V 1000	24374838	-		○
	140	20	21	90 NBR 109	N 1	17033	-		○
101,6	116,7	6,3	6,3	PTFE B602/NBR	OMS-MR	24307518	-		○
	122,1	8,1	8,1	PTFE B602/NBR	OMS-MR	24307542	-		○
102	112	7	7,5	31BF/70 A305	SPNC	GS2068-F0	-	○	
	117	10,9	12	95 AU V142	T 20	24360191	-		○
103	111	10	11	94 AU 925	KI 310	326226	-		○
	118,1	5,9	6,3	PTFE B602/NBR	OMS-MR	532499	-		○
104,78	125,28	8,1	8,1	PTFE B602/NBR	OMS-MR	24307543	-		○
105	113	6,5	7,5	94 AU 925	KI 310	329397	-		○
	113	10,9	12	95 AU V142	T 24	24302752	-		○
	115	7	7,5	31BF/70 A305	SPNC	GS2069-F0	-	○	
	115	10	11	95 AU V142	T 20	24366780	-		○
	115	12	13	95 AU V142	T 20	24213883	-		○
	118,4	7,3	7,5	19YF/A980	SPN	GS2315-V0	-	○	
	120	6,3	6,5	19YF/A305	SPNO	GS2824-V0	-	○	
	120	8	9	90 NBR 109	N 1	17058	-		○
	120	9	10	U641	ISI	FU1125-K1	-	○	
	120	9	10	U801	ISI	FU1125-K0	-	○	
	120	9	10	A505	IUH	CU1125-N1	-	○	
	120	9	10	A567	IUH	CU1125-N2	-	○	
	120	10	11	94 U801	IDI	FU1126-F0	-	○	
	120	11,4	12,5	95 AU V142	T 20	24300392 40422413	IP SP		● ●
	120	11,5	12,2	70 NBR B209	S 8	24007629	IP		●
	120,1	5,9	6,3	PTFE 55YF/70 A305	HBTS	GS5063-V6	-	○	
	120,1	5,9	6,3	PTFE B602/NBR	OMS-MR	24214072	IP		●
	120,1	5,9	6,3	PTFE B602/FKM	OMS-MR	24302829	-		○
	120,1	5,9	6,3	PTFE GM201/NBR	OMS-MR	24138660	-		○
	120,1	5,9	6,3	PTFE B602/NBR	OMS-MR PR	49015663	IP		●
	120,1	5,9	6,3	PTFE GM201/NBR	OMS-MR PR	49003864	IP		●
	120,1	5,9	6,3	95 AU V142	SYPRIM SM	24369062	-		○
	120,5	6	6,3	U641/12NM	HBV	FQ0629-F5	-	○	
	120,5	6	6,3	U801/12NM	HBV	FQ0629-F6	-	○	
	120,5	6	6,3	UH05/12NM	HBV	FQ1244-F0	-	○	
	125	9,4	10	PTFE GM201	OMS-S	24239117	-		○
	125	10	11	90 NBR 109	N 1	17059 40421511	IP SP		● ●
	125	12	13	A505	IUH	CU1128-N0	-	○	
	125	14,6	16	95 AU V142	T 20	24223317 40422269	IP SP		● ●
	125	15	16	94 AU 925	AUN 100	14374 40421231	IP SP		● ●
	125	15	16	94 U801	IDI	FU1129-F0	-	○	
	125	15	16	G928	IUH	CU1129-N0	-	○	
125	16	17	94 U801	IDI	FU1130-F0	-	○		
130	10	2,5	88 NBR 101	H MF	10394	-		○	
130	18	19	90 NBR 109	N 100	17941	-		○	
135	120	120	BHNR B5A151	V 1000	24192352	-		○	
106	118	12	13	90 NBR 109	N 1	11691	-		○

d [mm]	D [mm]	H [mm]	L [mm]	Material	Design	Part No.	PU ¹⁾	US	EU
106	121	9	10	U641	ISI	FU1136-K1	-	○	
	121	9	10	U801	ISI	FU1136-K0	-	○	
	121	10	11	94 U801	IDI	FU1137-F0	-	○	
	126	15	16	94 U801	IDI	FU1138-F0	-	○	
	126	16	17	94 U801	IDI	FU1139-F0	-	○	
107	115	8	9	94 AU 925	KI 310	353716	-		○
	122,1	5,9	6,3	PTFE B602/NBR	OMS-MR	24264452	-		○
107,95	123,05	5,9	6,3	PTFE GM201/NBR	OMS-MR	24307652	-		○
108	127	12,3	13,5	95 AU V142	T 20	24315960	-		○
110	118	10,9	12	95 AU V142	T 24	24309795 40422418	IP SP		● ●
	120	7	7,5	31BF/70 A305	SPNC	GS2070-F0	-	○	
	120	7,7	8,5	95 AU V142	T 20	24369546	-		○
	120	15	16	95 AU V142	NRS-0503	24187249	-		○
	123,4	7,3	7,5	19YF/A980	SPN	GS2316-V0	-	○	
	125	6,3	6,5	19YF/A305	SPNO	GS2825-V0	-	○	
	125	7,5	8,5	90 NBR 109	N 1	17039 40421510	IP SP		● ●
	125	9	9,9	95 AU V142	T 20	24374786	-		○
	125	9	10	U641	ISI	FU1157-K2	-	○	
	125	9	10	U801	ISI	FU1157-K0	-	○	
	125	9	10	A505	IUH	CU1157-N3	-	○	
	125	9	10	A567	IUH	CU1157-N5	-	○	
	125	9	10	G928	IUH	CU1157-N6	-	○	
	125	9,6	10,6	95 AU V142	T 20	24368411	-		○
	125	10	11	94 U801	IDI	FU1158-F0	-	○	
	125	10,9	12	94 AU 30000	T 20	49334210	-		○
	125	10,9	12	95 AU V142	T 20	24239427 40422326	IP SP		● ●
	125	11,3	12	70 NBR B209	S 8	24027631	IP		●
	125	11,3	12,5	92 AU 21100	HDR-2C	49308513	IP		●
	125	11,4	12,5	92 AU 21100	LF 300	49325971	-		○
	125	11,4	12,5	94 AU 925	LF 300	49325970	-		○
	125	12	13	94 AU 925	AUN 1	14532	-		○
	125	12	13	95 AU V142	T 20	24242341 40422330	IP SP		● ●
	125	14,6	16	95 AU V142	T 23	24377483	-		○
	125	15	16	94 AU 925	AUN 100	12144 40421105	IP SP	○	● ●
	125	15	16	94 AU 30000	NI 300	49334504	-		○
	125	15	16	94 AU 925	NI 300	30970 40421739	IP SP		● ●
	125	30	30	BHFKM B3K674	ESV	24099500	IP		●
	125,1	5,9	6,3	PTFE 55YF/70 A305	HBTS	GS5064-V6	-	○	
	125,1	5,9	6,3	PTFE B602/NBR	OMS-MR	24179236	IP		●
	125,1	5,9	6,3	PTFE B602/FKM	OMS-MR	24301675	-		○
	125,1	5,9	6,3	PTFE C104/NBR	OMS-MR	49023333	-		○
125,1	5,9	6,3	PTFE C104/FKM	OMS-MR	49044220	-		○	
125,1	5,9	6,3	PTFE GM201/NBR	OMS-MR	24119466	IP		●	
125,1	5,9	6,3	PTFE GM201/FKM	OMS-MR	24245340	-		○	
125,1	5,9	6,3	PTFE B602/NBR	OMS-MR PR	49002598	-		○	
125,1	5,9	6,3	PTFE C104/NBR	OMS-MR PR	49017740	-		○	

d [mm]	D [mm]	H [mm]	L [mm]	Material	Design	Part No.	PU ¹⁾	US	EU
110	125,1	5,9	6,3	PTFE GM201 / NBR	OMS-MR PR	49012225	-		○
	125,1	5,9	6,3	95 AU V142	SYPRIM SM	528762	-		○
	125,1	5,9	6,3	95 AU V142	SYPRIM SM	49318173	-		○
	125,5	6	6,3	U641 / 12NM	HBV	FG0262-F4	-	○	
	125,5	6	6,3	U801 / 12NM	HBV	FG0262-F6	-	○	
	125,5	6	6,3	UH05 / 12NM	HBV	FG1220-F0	-	○	
	130	9,4	10	PTFE GM201	OMS-S	24096141	-		○
	130	9,4	10	PTFE GM201	OMS-S	24375256	IP		●
	130	10	11	90 NBR 109	N 1	17065 40421512	IP SP		● ●
	130	11,8	13	95 AU V142	T 20	24376016	-		○
	130	12	3	88 NBR 101	H MF	10398	-		○
	130	12	13	94 AU 925	NI 300	21849 40421690	IP SP		● ●
	130	12	13	80 NBR 878	NI 400	24722	-		○
	130	14	15	80 NBR 878	NI 150	84555	-		○
	130	14,6	16	94 AU 30000	T 20	49334211	-		○
	130	14,6	16	95 AU V142	T 20	24223318 40422270	IP SP		● ●
	130	14,6	16	95 AU V142	T 22	24250868 40422368	IP SP		● ●
	130	14,6	16	95 AU V142	T 23	24265876	IP		●
	130	14,6	16	93 AU V167	TM 23	24296872	-		○
	130	14,6	16	93 AU V167	TMP 20	24370308	-		○
	130	15	16	94 AU 925	AUN 100	14298 40421192	IP SP	○	● ●
	130	15	16	94 U801	IDI	FU1165-F0	-	○	
	130	15	16	G928	IUH	CU1165-N0	-	○	
	130	15	16	94 AU 925	NI 300	21486 40421649	IP SP		● ●
	130	15	16	U801 / S813	UNI	FU1165-M1	-	○	
	130	16	16	94 AU 925	KI 320	351902	IP	○	●
	130	16	17	94 U801	IDI	FU1166-F0	-	○	
	130	18	19	94 AU 925	AUN 1	14530	-		○
	130	30	30	BHNBR B4B246	ES	24062205	-		○
	130	30	30	BHFKM B4K674	ESV	24220020	-		○
	130	32	32	BHNBR B4B246	ES	24220063	IP		●
	130	32	32	BHFKM B4K674	ESV	24220021	-		○
	130	40	40	BHNBR B4B246	ES	24070233	IP		●
	130	40	40	BHFKM B4K674	ESV	24107792	IP		●
	135	12	13	90 NBR 109	N 1	17037	-		○
	135	15	16	94 AU 925	NI 300	401889	-		○
	135	15	16	80 NBR 878	NI 400	24724	-		○
	135	18	19	85 NBR B247	L 20	24096775	-		○
	135	18	19	90 NBR 109	N 100	17719 40421538	IP SP	○	● ●
	135	40	40	BHNBR B4B246	ES	24220064	IP		●
	135	40	40	BHFKM B4K674	ESV	24220022	-		○
	135	97,6	97,6	BHNBR B5B210	V 1000	24077738	-		○
135	98,5	98,5	BHNR B5A151	V 1000	24071540	-		○	
140	15	16	94 AU 925	AUN 1	14529	-		○	
140	15	16	90 NBR 109	N 1	15905	-		○	
140	18	19	90 NBR 109	N 100	17942	-		○	

d [mm]	D [mm]	H [mm]	L [mm]	Material	Design	Part No.	PU ¹⁾	US	EU
110	140	95	95	BHNBR B5B210	V 1000	24073933	-		○
	140	145	145	BHNBR B5B210	V 1000	24363205	-		○
111,1	126,2	5,9	6,3	PTFE B602 /FKM	OMS-MR	24375984	-		○
111,13	131,63	8,1	8,1	PTFE B602 /NBR	OMS-MR	24307545	-		○
111,7	131,7	9,4	10	PTFE GM201	OMS-S	24234942	-		○
112	122	7	7,5	31BF /70 A305	SPNC	GS2071-F0	-	○	
	125	8,5	9,5	A505	IUH	CU1178-N0	-	○	
	125	9	10	U641	ISI	FU1179-K1	-	○	
	125	9	10	U801	ISI	FU1179-K0	-	○	
	127	9	10	94 U801	IDI	FU1180-F0	-	○	
	127	10	11	94 U801	IDI	FU1181-F0	-	○	
	127,1	5,9	6,3	PTFE 55YF /70 A305	HBTS	GS5065-V6	-	○	
	132	15	16	94 U801	IDI	FU1182-F0	-	○	
	132	16	17	94 U801	IDI	FU1183-F0	-	○	
	113	128,1	5,9	6,3	PTFE B602 /NBR	OMS-MR	532500	-	
113,3	133,3	9,4	10	PTFE GM201	OMS-S	24214297	-		○
114,3	133,35	15,2	16,7	95 AU V142	T 20	24296086	-		○
	134,8	8,1	8,1	PTFE B602 /NBR	OMS-MR	24307546	-		○
115	139,3	105	105	BHNR B5A151	V 1000	24256650	-		○
	124	15	16	94 AU 925	KI 310	310030 40421868	IP SP		● ●
	125	7	7,5	31BF /70 A305	SPNC	GS2072-F0	-	○	
	130	6,3	6,5	19YF /A305	SPNO	GS2826-V0	-	○	
	130	9	10	U641	ISI	FU1195-K2	-	○	
	130	9	10	U801	ISI	FU1195-K1	-	○	
	130	9	10	A505	IUH	CU1195-N0	-	○	
	130	9	10	A567	IUH	CU1195-N1	-	○	
	130	10,9	12	95 AU V142	T 20	24251889 8004-251.889	-	●	○
	130	11,3	12	70 NBR B209	S 8	24007645	IP		●
	130	11,4	12,5	94 AU 30000	LF 300	49334417	-		○
	130	11,4	12,5	95 AU V142	LF 300	49063604	IP		●
	130	13	13	94 AU 925	KI 320	354245	-		○
	130,1	5,9	6,3	PTFE 55YF /70 A305	HBTS	GS5066-V6	-	○	
	130,1	5,9	6,3	PTFE B602 /NBR	OMS-MR	24179237	IP		●
	130,1	5,9	6,3	PTFE B602 /FKM	OMS-MR	24344729	-		○
	130,1	5,9	6,3	PTFE C104 /NBR	OMS-MR	49060434	-		○
	130,1	5,9	6,3	PTFE GM201 /NBR	OMS-MR	24131216	-		○
	130,1	5,9	6,3	PTFE GM201 /NBR	OMS-MR PR	49018445	IP		●
	130,1	5,9	6,3	95 AU V142	SYPRIM SM	533605 0536-533.605	-	●	○
130,5	6	6,3	U641 / 12NM	HBV	FQ0868-F4	-	○		
130,5	6	6,3	U801 / 12NM	HBV	FQ0868-F5	-	○		
130,5	6	6,3	UH05 / 12NM	HBV	FQ0868-F7	-	○		
135	9,3		PTFE F52902	TFV	236	-		○	
135	9,4	10	PTFE GM201	OMS-S	24096142	-		○	
135	9,4	10	PTFE GM201	OMS-S	24275259	-		○	
135	14,6	16	95 AU V142	T 20	24223319 40422271	IP SP		● ●	
135	15	16	94 AU 925	AUN 100	14375 40421232	IP SP	○	● ●	
135	16	17	G928	IUH	CU1184-N0	-	○		

d [mm]	D [mm]	H [mm]	L [mm]	Material	Design	Part No.	PU ¹⁾	US	EU
115	140	12	13	90 NBR 109	N 1	17073	-		○
	140	15	16	94 AU 925	NI 300	407165	-		○
	140	15	16	80 NBR 878	NI 400	24225	-		○
	140	17,3	19	95 AU V142	T 20	24361949	-		○
	140	18	19	90 NBR 109	N 100	17769 40421544	IP SP		● ●
	140	34	34	BHNBR B4B246	ES	24081735	-		○
	140	34	34	BHFKM B4K674	ESV	24220023	-		○
	140	46	46	BHNBR B4B246	ES	24070234	IP		●
	140	46	46	BHFKM B4K674	ESV	24119599	-		○
	145	95	95	BHNBR B5B210	V 1000	24147044	-		○
145	120	120	BHNBR B5B210	V 1000	24096333	-		○	
117,48	137,98	8,1	8,1	PTFE B602/NBR	OMS-MR	24307547	-		○
118	126	10,9	12	95 AU V142	T 24	24308891	-		○
	126	13	14	94 AU 925	KI 310	323088	-		○
	133	9	10	U641	ISI	FU1205-K1	-	○	
	133	9	10	U801	ISI	FU1205-K0	-	○	
	133	10	11	94 U801	IDI	FU1206-F0	-	○	
	133,1	5,9	6,3	PTFE B602/NBR	OMS-MR	24356045	-		○
	138	15	16	94 U801	IDI	FU1207-F0	-	○	
	138	16	17	94 U801	IDI	FU1208-F0	-	○	
120	128	10,9	12	95 AU V142	T 24	24302753 40422416	IP SP		● ●
	130	7	7,5	31BF/70 A305	SPNC	GS2073-F0	-	○	
	133,4	7,3	7,5	19YF/A980	SPN	GS2317-V0	-	○	
	135	6,3	6,5	19YF/A305	SPNO	GS2827-V0	-	○	
	135	9	10	U641	ISI	FU1220-K1	-	○	
	135	9	10	U801	ISI	FU1220-K0	-	○	
	135	9	10	A505	IUH	CU1220-N3	-	○	
	135	9	10	A567	IUH	CU1220-N2	-	○	
	135	10	11	94 U801	IDI	FU1221-F0	-	○	
	135	10,9	12	95 AU V142	T 20	24360190	-		○
	135	11,3	12	70 NBR B209	S 8	24084364	IP		●
	135	11,4	12,5	94 AU 925	LF 300	49058439	-		○
	135	11,4	13	95 AU V157	TM 23	24296681	-		○
	135	14,6	16	95 AU V142	T 23	24344467	-		○
	135	14,6	16	95 AU V157	TM 23	24313025	-		○
	135	15	16	94 AU 30000	NI 300	49334505	-		○
	135	15	16	94 AU 925	NI 300	21493 40421650	IP SP		● ●
	135	16	16	94 AU 925	KI 320	351903	-		○
	135,1	5,9	6,3	PTFE 55YF/70 A305	HBTS	GS5067-V6	-	○	
	135,1	5,9	6,3	PTFE B602/NBR	OMS-MR	24214075	IP		●
	135,1	5,9	6,3	PTFE B602/FKM	OMS-MR	24292144	-		○
	135,1	5,9	6,3	PTFE GM201/FKM	OMS-MR	531738	-		○
	135,1	5,9	6,3	PTFE GM201/NBR	OMS-MR	24196902	-		○
	135,1	5,9	6,3	PTFE B602/NBR	OMS-MR PR	49002599	IP		●
	135,1	5,9	6,3	PTFE C104/NBR	OMS-MR PR	49017277	-		○
	135,1	5,9	6,3	PTFE GM201/NBR	OMS-MR PR	49012945	-		○
	135,5	6	6,3	U641/12NM	HBV	FQ0263-F5	-	○	
	135,5	6	6,3	U801/12NM	HBV	FQ0263-F4	-	○	

d [mm]	D [mm]	H [mm]	L [mm]	Material	Design	Part No.	PU ¹⁾	US	EU
	135,5	6	6,3	UH05 / 12NM	HBV	FQ0263-F8	-	○	
	140	9,4	10	PTFE GM201	OMS-S	24182344	-		○
	140	9,4	10	PTFE B602	OMS-S PR	49001459	-		○
	140	10	11	90 NBR 109	N 1	17084 40421514	IP SP		● ●
	140	11,4	12,5	95 AU V142	T 22	24289915	-		○
	140	12	13	94 AU 925	NI 300	21497 40421651	IP SP		● ●
	140	14,6	16	94 AU 30000	T 20	49334212	-		○
	140	14,6	16	95 AU V142	T 20	24223320 40422272	IP SP		● ●
	140	14,6	16	95 AU V142	T 22	24250869	-		○
	140	15	16	94 AU 925	AUN 100	14311 40421194	IP SP		● ●
	140	15	16	94 U801	IDI	FU1224-F0	-	○	
120	140	15	16	G928	IUH	CU1224-N0	-	○	
	140	15	16	94 AU 925	NI 300	21500 40421652	IP SP		● ●
	140	15	16	U801 / S813	UNI	FU1224-M1	-	○	
	140	16	17	94 U801	IDI	FU1225-F0	-	○	
	145	17,3	19	95 AU V142	T 20	24371176	-		○
	145	18	19	85 NBR B247	L 20	24096776	-		○
	145	18	19	90 NBR 109	N 100	17779	-		○
	148	15	6	88 NBR 101	H OF	10410	-		○
	150	15	16	90 NBR 109	N 1	17082 40421513	IP SP		● ●
	150	18	19	90 NBR 109	N 100	17943 40421564	IP SP		● ●
	150	118,5	118,5	BHNR B5B210	V 1000	24087474	-		○
	150	120	120	BHNR B5A151	V 1000	24105125	-		○
	175	20	4	88 NBR 101	H MF	10409	-	○	○
120,7	152,4	123,8	123,8	BHNR B5A151	V 1000	24183246	-		○
	133	6,5	7,5	94 AU 925	KI 310	329398	-		○
	133	10,9	12	95 AU V142	T 24	24316541 40422458	IP SP		● ●
	135	7	7,5	31BF / 70 A305	SPNC	GS2074-F0	-	○	
	137,2	9	9,5	PTFE F56110	FOI	160404	IP		●
	140	6,3	6,5	19YF / A305	SPNO	GS2828-V0	-	○	
	140	6,8	1,5	88 NBR 101	H OF	10412	-		○
	140	9	10	U641	ISI	FU1252-K1	-	○	
	140	9	10	U801	ISI	FU1252-K0	-	○	
	140	9	10	A505	IUH	CU1252-N3	-	○	
125	140	9	10	A567	IUH	CU1252-N5	-	○	
	140	10	11	94 U801	IDI	FU1253-F0	-	○	
	140	10,9	12	94 AU 30000	T 20	49334213	-		○
	140	10,9	12	95 AU V142	T 20	24251890 40422372 8004-251.890	IP SP -	○	● ●
	140	11,3	12	70 NBR B209	S 8	24027653	IP		●
	140	11,4	12,5	95 AU V142	T 23	24332131	-		○
	140	11,4	13	93 AU V167	TM 23	24294247	-		○
	140	15	16	94 AU 925	AUN 100	12205 40421109	IP SP		● ●
	140	34	34	BIFKM B3K674	ESV	24139062	-		○

d [mm]	D [mm]	H [mm]	L [mm]	Material	Design	Part No.	PU ¹⁾	US	EU
	140,1	5,9	6,3	PTFE 55YF / 70 A305	HBTS	GS5068-V6	-	○	
	140,1	5,9	6,3	PTFE B602 / NBR	OMS-MR	24179238	IP		●
	140,1	5,9	6,3	PTFE B602 / FKM	OMS-MR	24332957	IP		●
	140,1	5,9	6,3	PTFE C104 / NBR	OMS-MR	49045402	-		○
	140,1	5,9	6,3	PTFE GM201 / NBR	OMS-MR	24131217	IP		●
	140,1	5,9	6,3	PTFE GM201 / FKM	OMS-MR	24259135	-		○
	140,1	5,9	6,3	PTFE B602 / NBR	OMS-MR PR	49015916	-		○
	140,1	5,9	6,3	PTFE C104 / NBR	OMS-MR PR	49017741	-		○
	140,1	5,9	6,3	PTFE GM201 / NBR	OMS-MR PR	49010807	-		○
	140,1	5,9	6,3	PTFE GM201 / FKM	OMS-MR PR	49013002	-		○
	140,1	5,9	6,3	95 AU V142	SYPRIM SM	24357329	IP		●
	140,5	6	6,3	U641 / 12NM	HBV	FQ0842-F4	-	○	
	140,5	6	6,3	U801 / 12NM	HBV	FQ0842-F3	-	○	
	140,5	6	6,3	UH05 / 12NM	HBV	FQ0842-F7	-	○	
	145	9,4	10	PTFE GM202	OMS-S	24096143	-		○
	145	9,4	10	PTFE GM202	OMS-S	24275260	IP		●
	145	9,4	10	PTFE GM201	OSES-0277	49013193	-		○
	145	10	11	90 NBR 109	N 1	17089	-		○
	145	12	13	94 U801	IDI	FU1256-F0	-	○	
	145	12	13	94 AU 925	NI 300	21852 40421691	IP SP		● ●
	145	12	13	80 NBR 878	NI 400	24725	IP		●
	145	14	15	80 NBR 878	NI 150	84556	-		○
	145	14,6	16	95 AU V142	T 20	24223321 40422273 8004-223.321	IP SP -	○	● ●
125	145	14,6	16	95 AU V142	T 22	24250870 40422369	IP SP		● ●
	145	14,6	16	95 AU V142	T 23	24302159	IP		●
	145	15	16	94 AU 925	AUN 100	14386 40421235	IP SP		● ●
	145	15	16	94 AU 30000	NI 300	49334506	-		○
	145	15	16	94 AU 925	NI 300	21501 40421653	IP SP		● ●
	145	16	16	94 AU 925	KI 320	351904	IP	○	●
	145	16	17	94 U801	IDI	FU1258-F0	-	○	
	145	32	32	BH-NBR B4B246	ES	24220065	IP		●
	145	32	32	BH-FKM B4K674	ESV	24220024	-		○
	150	15	16	94 AU 925	NI 300	401892	-		○
	150	15	16	80 NBR 878	NI 400	24726	-		○
	150	18	19	90 NBR 109	N 100	17944 40421565	IP SP		● ●
	150	19	20	94 U801	IDI	FU2132-F0	-	○	
	150	20	21	94 U801	IDI	FU1260-F0	-	○	
	150	34	34	BH-NBR B4B246	ES	24062207	-		○
	150	34	34	BH-FKM B4K674	ESV	24220025	-		○
	150	40	40	BH-NBR B4B246	ES	24220066	IP		●
	150	40	40	BH-FKM B4K674	ESV	24220026	-		○
	150	46	46	BH-NBR B4B246	ES	24070235	IP		●
	150	46	46	BH-FKM B4K674	ESV	24139162	-		○
	150	52	52	MAHPT C9T003	DMS	24293273	-		○
	150	98,5	98,5	BHNR B5A151	V 1000	24074297	-		○
	155	15	16	90 NBR 109	N 1	17090	-		○

d [mm]	D [mm]	H [mm]	L [mm]	Material	Design	Part No.	PU ¹⁾	US	EU
125	155	17,3	19	95 AU V142	T 20	24371643	-		○
	155	18	19	94 AU 925	NI 300	21505	-		○
	155	18	19	80 NBR B246	Seal Set 0216	24291122	-		○
	155	95	95	BHNBR B5B210	V 1000	24072133	-		○
	155	95	95	BHNBR B5B210	V 1000	24075731	-		○
	155	95	95	BHNR B5A151	V 1000	24089158	-		○
	155	120	120	BHNBR B5B210	V 1000	24079394	-		○
	155	120	120	BHNBR B5B210	V 1000	24079853	-		○
126	141,1	5,9	6,3	PTFE GM201 / NBR	OMS-MR	24241599	-		○
	128	143,1	5,9	6,3	PTFE B602 / NBR	OMS-MR	24380364	-	
130	138	10,9	12	95 AU V142	T 24	24336027	-		○
	140	7	7,5	31BF / 70 A305	SPNC	GS2075-F0	-	○	
	140	15	16	95 AU V142	T 20	24213884	-		○
	142	9	9,5	70 NBR B209	S 8	24007661	-		○
	143,4	7,3	7,5	19YF / A980	SPN	GS2318-V0	-	○	
	145	6,3	6,5	19YF / A305	SPNO	GS2829-V0	-	○	
	145	9	10	U641	ISI	FU1280-K1	-	○	
	145	9	10	U801	ISI	FU1280-K0	-	○	
	145	9	10	A505	IUH	CU1280-N0	-	○	
	145	9	10	A567	IUH	CU1280-N1	-	○	
	145	10	11	94 U801	IDI	FU1281-F0	-	○	
	145	10	11	95 AU V142	T 20	24359621	IP		●
	145	10,2	11	70 NBR B209	S 8	24031801	IP		●
	145	13,7	15	95 AU V142	T 20	24362610	-		○
	145	14,6	16	95 AU V142	T 20	24358619	-		○
	145,1	5,9	6,3	PTFE 55YF / 70 A305	HBTS	GS5069-V6	-	○	
	145,1	5,9	6,3	PTFE B602 / NBR	OMS-MR	24214077	-		○
	145,1	5,9	6,3	PTFE B602 / FKM	OMS-MR	24298480	-		○
	145,1	5,9	6,3	PTFE B602 / NBR	OMS-MR	24346876	IP		●
	145,1	5,9	6,3	PTFE GM201 / NBR	OMS-MR	24193747	-		○
	145,1	5,9	6,3	PTFE B602 / NBR	OMS-MR PR	49002600	-		○
	145,1	5,9	6,3	PTFE C104 / NBR	OMS-MR PR	49036920	-		○
	145,1	5,9	6,3	PTFE GM201 / NBR	OMS-MR PR	49012252	IP		●
	145,1	5,9	6,3	95 AU V142	SYPRIM SM	49307655	IP		●
	145,5	6	6,3	U641 / 12NM	HBV	FQ0264-F4	-	○	
	145,5	6	6,3	U801 / 12NM	HBV	FQ0264-F5	-	○	
	145,5	6	6,3	UH05 / 12NM	HBV	FQ0264-F8	-	○	
	150	9,4	10	PTFE GM201	OMS-S	24124096	-		○
	150	9,4	10	PTFE GM201	OMS-S	24375615	-		○
	150	10	11	90 NBR 109	N 1	17103 40421515	IP SP	○	●
	150	12	3	88 NBR 101	H MF	10418	-		○
	150	12	13	94 U801	IDI	FU1283-F0	-	○	
	150	12	13	94 AU 925	NI 300	21511 40421654	IP SP		●
150	14,6	16	94 AU 30000	T 20	49334418	-		○	
150	14,6	16	95 AU V142	T 20	24223322 40422274	IP SP		●	
150	15	16	94 AU 925	AUN 100	14293 40421190	IP SP	○	●	

d [mm]	D [mm]	H [mm]	L [mm]	Material	Design	Part No.	PU ¹⁾	US	EU
130	150	15	16	94 AU 925	NI 300	21514 40421655	IP SP		● ●
	150	16	17	94 U801	IDI	FU1285-F0	-	○	
	150	16	17	G928	IUH	CU2771-N0	-	○	
	150	16	17	U801 / S813	UNI	FU1285-M1	-	○	
	155	18	19	90 NBR 109	N 100	17945	-		○
	160	15	16	94 AU 925	AUN 1	14560	-		○
	160	15	16	90 NBR 109	N 1	17101	-		○
	160	17,3	19	95 AU V142	T 20	24370486	-		○
	160	18	19	90 NBR 109	N 100	17853 40421551	IP SP		● ●
	160	118,5	118,5	BHNBR B5B210	V 1000	24103497	-		○
170	158	158	BHNR B6A151	V 1000	527666	-		○	
132	142	7	7,5	31BF / 70 A305	SPNC	GS2076-F0	-	○	
	147,1	5,9	6,3	PTFE B602 / NBR	OMS-MR	24347998	-		○
	147,5	6	6,3	U641 / 12NM	HBV	FG0784-F3	-	○	
	147,5	6	6,3	U801 / 12NM	HBV	FG0784-F2	-	○	
	157	20	21	94 U801	IDI	FU1295-F0	-	○	
133,35	148,45	6,3	6,3	PTFE B602 / NBR	OMS-MR	24307528	-		○
133,4	152,4	12,3	13,5	95 AU V142	T 20	24315961	-		○
	158,4	98,5	98,5	BHNR B5A151	V 1000	24080602	-		○
	165,4	128	128	BHNR B5A151	V 1000	24140755	-		○
145	7	7,5	31BF / 70 A305	SPNC	GS2077-F0	-	○		
150	6,3	6,5	19YF / A305	SPNO	GS2830-V0	-	○		
150	9	10	A505	IUH	CU2264-N2	-	○		
150	9	10	A567	IUH	CU2264-N0	-	○		
150	10	11	90 NBR 109	N 1	11701 40421081	IP SP		● ●	
150	10	11	70 NBR B209	S 8	24027636	IP		●	
150,1	5,9	6,3	PTFE 55YF / 70 A305	HBTS	GS5070-V6	-	○		
150,1	5,9	6,3	PTFE B602 / NBR	OMS-MR	24223165	-		○	
150,1	5,9	6,3	PTFE GM201 / NBR	OMS-MR	24213365	-		○	
150,1	5,9	6,3	PTFE B602 / NBR	OMS-MR PR	49046536	-		○	
150,1	5,9	6,3	PTFE C104 / NBR	OMS-MR PR	49018331	-		○	
135	150,5	6	6,3	U641 / 12NM	HBV	FG0904-F3	-	○	
	150,5	6	6,3	U801 / 12NM	HBV	FG0904-F2	-	○	
	155	14,6	16	95 AU V142	T 20	24360106	-		○
	155	14,6	16	93 AU V167	TM 23	24369133	-		○
	155	15	16	94 AU 925	AUN 100	14376 40421233	IP SP		● ●
	160	12	13	90 NBR 109	N 1	11702 40421082	IP SP		● ●
	160	18	19	90 NBR 109	N 100	17877 40421555	IP SP	○	● ●
	160	19	20	94 U801	IDI	FU2133-F0	-	○	
	160	20	21	94 U801	IDI	FU2179-F0	-	○	
	165	17,3	19	95 AU V142	T 20	24362625	-		○
165	18	19	90 NBR 109	N 100	17946	-		○	
165	95	95	BHNBR B5B210	V 1000	24259745	-		○	
175	126	126	BHNR B6B210	V 1000	24074448	-		○	
138	153,1	5,9	6,3	PTFE B602 / NBR	OMS-MR	24380372	-		○
138,2	153,3	5,9	6,3	PTFE B602 / NBR	OMS-MR	24380375	-		○

d [mm]	D [mm]	H [mm]	L [mm]	Material	Design	Part No.	PU ¹⁾	US	EU
139,7	154,8	6,3	6,3	PTFE B602 / NBR	OMS-MR	24307530	-		○
	150	7	7,5	31BF / 70 A305	SPNC	GS2078-F0	-	○	
	152	8,6	9,5	95 AU V142	T 20	49003440	-		○
	153,4	7,3	7,5	19YF / A980	SPN	GS2319-V0	-	○	
	155	6,3	6,5	19YF / A305	SPNO	GS2831-V0	-	○	
	155	9	10	U641	ISI	FU1323-K2	-	○	
	155	9	10	U801	ISI	FU1323-K0	-	○	
	155	9	10	A505	IUH	CU1323-N2	-	○	
	155	9	10	A567	IUH	CU1323-N3	-	○	
	155	10	11	94 U801	IDI	FU1324-F0	-	○	
	155	11,4	12,5	95 AU V142	T 20	24357236	-		○
	155	13	14	70 NBR B209	S 8	24057871	-		○
	155	34	34	BHFKM B3K674	ESV	24139063	IP		●
	155,1	5,9	6,3	PTFE 55YF / 70 A305	HBTS	GS5071-V6	-	○	
	155,1	5,9	6,3	PTFE B602 / NBR	OMS-MR	24179239	IP		●
	155,1	5,9	6,3	PTFE B602 / FKM	OMS-MR	24332958	IP		●
	155,1	5,9	6,3	PTFE GM201 / NBR	OMS-MR	24131218	IP		●
	155,1	5,9	6,3	PTFE GM201 / FKM	OMS-MR	24245342	-		○
	155,1	5,9	6,3	PTFE B602 / NBR	OMS-MR PR	49015917	IP		●
	155,1	5,9	6,3	PTFE C104 / NBR	OMS-MR PR	49024657	-		○
	155,1	5,9	6,3	PTFE GM201 / NBR	OMS-MR PR	49004553	IP		●
	155,1	5,9	6,3	95 AU V142	SYPRIM SM	49307656	IP		●
	155,5	6	6,3	U641 / 12NM	HBV	FQ0265-F4	-	○	
	155,5	6	6,3	U801 / 12NM	HBV	FQ0265-F5	-	○	
	155,5	6	6,3	UH05 / 12NM	HBV	FQ0265-F6	-	○	
140	160	9,4	10	PTFE B602	OMS-S	24349995	-		○
	160	9,4	10	PTFE GM201	OMS-S	24096144	-		○
	160	9,4	10	PTFE GM201	OMS-S	24367092	IP		●
	160	9,4	10	PTFE B602	OMS-S PR	532876	-		○
	160	11,8	13	95 AU V142	T 20	24376017	-		○
	160	12	13	94 U801	IDI	FU1325-F0	-	○	
	160	12	13	94 AU 925	NI 300	21516 40421656	IP SP		● ●
	160	12	13	80 NBR 878	NI 400	24728	-		○
	160	14	15	80 NBR 878	NI 150	84557	-		○
	160	14,6	16	94 AU 30000	T 20	49334419	-		○
	160	14,6	16	95 AU V142	T 20	24223323 40422275	IP SP		● ●
	160	14,6	16	95 AU V142	T 22	24250871	-		○
	160	14,6	16	95 AU V142	T 23	24302160	IP		●
	160	15	16	94 AU 925	AUN 100	14321 40421197	IP SP		● ●
	160	15	16	94 AU 30000	NI 300	49334507	-		○
	160	15	16	94 AU 925	NI 300	21518 40421657	IP SP		● ●
	160	15	16	70 NBR B209	S 8	24007671	IP		●
	160	16	16	94 AU 925	KI 320	351905	IP	○	●
	160	16	17	94 U801	IDI	FU1328-F0	-	○	
	160	32	32	BHNBR B4B246	ES	24194357	IP		●
	160	32	32	BHFKM B4K674	ESV	24220027	-		○
	165	15	16	94 AU 925	NI 300	401895	IP		●
	165	15	16	80 NBR 878	NI 400	24729	-		○

d [mm]	D [mm]	H [mm]	L [mm]	Material	Design	Part No.	PU ¹⁾	US	EU
	165	18	19	90 NBR 109	N 100	17855	-		○
	165	19	20	94 U801	IDI	FU1332-F0	-	○	
	165	19	20	U801 / S813	UNI	FU1332-M1	-	○	
	165	20	21	94 U801	IDI	FU1333-F0	-	○	
	165	34	34	BHNBR B4B246	ES	24220067	-		○
	165	34	34	BHFKM B4K674	ESV	24220028	-		○
	165	40	40	BHNBR B4B246	ES	24220068	IP		●
	165	40	40	BHFKM B4K674	ESV	24220029	-		○
	165	46	46	BHNBR B4B246	ES	24070236	IP		●
	165	46	46	BHFKM B4K674	ESV	24139305	IP		●
	165	52	52	MAHPT C9T003	DMS	24293274	-		○
	165	98,5	98,5	BHNR B5A151	V 1000	24086537	-		○
	165	102	102	BHNR B5A151	V 1000	24140697	-		○
	170	12	2,5	88 NBR 101	H MF	10429 40421075	IP SP		● ●
140	170	15	16	90 NBR 109	N 1	17112	-		○
	170	17,3	19	95 AU V142	T 20	24377812	-		○
	170	18	19	90 NBR 109	N 100	17947 40421566	IP SP		● ●
	170	18	19	94 AU 925	NI 300	21520	-		○
	170	18	19	80 NBR B246	Seal Set O214	24314112	-		○
	170	18	19	80 NBR B246	Seal Set O216	24314111	-		○
	170	93	93	BHNBR B5B210	V 1000	24067777	-		○
	170	95	95	BHNBR B5B210	V 1000	24102051	-		○
	170	95	95	BHNBR B5B210	V 1000	24141626	-		○
	170	100	100	BHNBR B5B210	V 1000	24073934	-		○
	170	120	120	BHNBR B5B210	V 1000	24073931	-		○
	170	131	131	BHNR B5A151	V 1000	24373175	-		○
	170	140,5	140,5	BHNR B5A151	V 1000	24342149	-		○
	170	150	150	BHNBR B5B210	V 1000	24261010	-		○
	175	20	21	90 NBR 109	N 1	11704	-		○
143	151	10,9	12	95 AU V142	T 24	24308892	-		○
	151	13	14	94 AU 925	KI 310	323089	-		○
	153	6,5	7,5	94 AU 925	KI 310	329396	-		○
	155	7	7,5	31BF / 70 A305	SPNC	GS2079-F0	-	○	
	157	8,5	9,5	95 AU V142	T 20	24380733	-		○
	160	6,3	6,5	19YF / A305	SPNO	GS2832-V0	-	○	
	160	9	10	U641	ISI	FU1343-K1	-	○	
	160	9	10	U801	ISI	FU1343-K0	-	○	
	160	9	10	A505	IUH	CU1343-N0	-	○	
	160,1	5,9	6,3	PTFE B602 / NBR	OMS-MR	24314587	IP		●
145	160,1	5,9	6,3	PTFE GM201 / NBR	OMS-MR	24380689	-		○
	160,1	5,9	6,3	PTFE C104 / NBR	OMS-MR PR	49017742	-		○
	165	9,4	10	PTFE B602	OMS-S	49008072	-		○
	165	9,4	10	PTFE B604	OMS-S	49033900	-		○
	165	9,4	10	PTFE GM201	OMS-S	24138538	-		○
	165	14,6	16	95 AU V142	T 20	24375686	-		○
	165	15	16	94 AU 925	AUN 100	14340	-		○
	165	16	17,5	93 AU V167	TM 23	24354392	-		○
	170	15	16	90 NBR 109	N 1	17117	-		○
	170	19	20	94 U801	IDI	FU2134-F0	-	○	

d [mm]	D [mm]	H [mm]	L [mm]	Material	Design	Part No.	PU ¹⁾	US	EU
145	170	20	21	94 U801	IDI	FU2180-F0	-	○	
	175	15	16	90 NBR 109	N 1	17116	-		○
	175	18	19	90 NBR 109	N 100	17949	-		○
	175	117,4	117,4	BNBR B5B210	V 1000	24067697	-		○
147	162,1	5,9	6,3	PTFE B602/NBR	OMS-MR	24359534	-		○
149,23	164,33	5,9	6,3	PTFE GM201/NBR	OMS-MR	24307664	-		○
150	158	10,9	12	95 AU V142	T 24	24336028	-		○
	160	7	7,5	31BF/70 A305	SPNC	GS2081-F0	-	○	
	165	9	10	U641	ISI	FU1359-K1	-	○	
	165	9	10	U801	ISI	FU1359-K0	-	○	
	165	9	10	A505	IUH	CU1359-N2	-	○	
	165	9	10	A567	IUH	CU1359-N4	-	○	
	165	10	11	94 U801	IDI	FU1360-F0	-	○	
	165	10,5	11	31BF/70 A305	SPNC	GS2080-F0	-	○	
	165,1	5,9	6,3	PTFE 55YF/70 A305	HBTS	GS5072-V6	-	○	
	165,1	5,9	6,3	PTFE B602/NBR	OMS-MR	24179240	IP		●
	165,1	5,9	6,3	PTFE B602/FKM	OMS-MR	24265511	-		○
	165,1	5,9	6,3	PTFE C104/FKM	OMS-MR	49036330	-		○
	165,1	5,9	6,3	PTFE GM201/NBR	OMS-MR	24131219	-		○
	165,1	5,9	6,3	PTFE B602/NBR	OMS-MR PR	49016162	IP		●
	165,1	5,9	6,3	PTFE C104/NBR	OMS-MR PR	49020172	IP		●
	165,1	5,9	6,3	PTFE GM201/NBR	OMS-MR PR	49005153	IP		●
	165,1	5,9	6,3	95 AU V142	SYPRIM SM	24357330	-		○
	165,5	6	6,3	U641/12NM	HBV	FQ0871-F4	-	○	
	165,5	6	6,3	U801/12NM	HBV	FQ0871-F3	-	○	
	165,5	6	6,3	UH05/12NM	HBV	FQ0871-F6	-	○	
	170	9,4	10	PTFE GM201	OMS-S	24096145	IP		●
	170	9,4	10	PTFE GM201	OMS-S	49040644	-		○
	170	9,4	10	PTFE B602	OMS-S PR	529349	-		○
	170	9,8	10	19YF/A305	SPNO	GS2833-V0	-	○	
	170	10	11	90 NBR 109	N 1	17122 40421516	IP SP		● ●
	170	11,8	13	95 AU V142	T 20	24295710	-		○
	170	12	13	94 U801	IDI	FU1361-F0	-	○	
	170	14,6	16	95 AU V142	T 20	24223324 40422276	IP SP		● ●
	170	14,6	16	95 AU V142	T 22	24250872	-		○
	170	15	16	94 AU 925	AUN 100	14330 40421200	IP SP		● ●
	170	15	16	94 AU 925	NI 300	18792 40421599	IP SP		● ●
	170	15	16	70 NBR B209	S 8	24007682	IP		●
	170	16	17	94 U801	IDI	FU1364-F0	-	○	
	170	18	19	94 AU 925	AUN 1	103802	-		○
	175	16	17	94 U801	IDI	FU1366-F0	-	○	
	175	20	21	94 U801	IDI	FU1368-F0	-	○	
180	15	16	94 AU 925	AUN 1	103804	-		○	
180	15	16	90 NBR 109	N 1	17120	-		○	
180	17,3	19	95 AU V142	T 20	24223325	-		○	
180	18	19	90 NBR 109	N 100	17760 40421542	IP SP		● ●	
180	18	19	94 AU 925	NI 300	21522	-		○	

d [mm]	D [mm]	H [mm]	L [mm]	Material	Design	Part No.	PU ¹⁾	US	EU
	180	18	19	80 NBR 878	NI 400	4484	-		○
	180	18	19	80 NBR B246	Seal Set O214	24296304	-		○
	180	45	45	BHNBR B4B246	ES	24061736	IP		●
	180	45	45	BIFKM B4K674	ESV	24220030	-		○
	180	60	60	BHNBR B4B246	ES	24070237	IP		●
	180	60	60	BHNBR B4B246	ES	24170282	-		○
	180	60	60	BIFKM B4K674	ESV	24148030	-		○
150	180	100	100	BHNBR B5B210	V 1000	24086426	-		○
	180	100	100	BHNBR B5B210	V 1000	24144999	-		○
	180	100	100	BHNR B5A151	V 1000	24072331	-		○
	180	120	120	BHNR B5A151	V 1000	24092789	-		○
	180	150	150	BHNBR B5B210	V 1000	24103411	-		○
	190	14	4	88 NBR 101	H MF	10437	-		○
	190	158	158	BHNBR B6B210	V 1000	24105019	-		○
	190	190	190	BHNBR B6B210	V 1000	24082060	-		○
151	166,1	5,9	6,3	PTFE B602 /NBR	OMS-MR	49002207	-		○
	167,5	5,9	6,3	PTFE B602 /NBR	OMS-MR	24301245	-		○
152,4	172,9	7,6	8,1	PTFE B602 /NBR	OMS-MR	24307558	-		○
	177,8	104,7	104,7	BHNR B5A151	V 1000	24098595	-		○
153	173	9,4	10	PTFE B602	OMS-S PR	49018309	-		○
	163	11,4	12	95 AU V142	T 24	24269864	-		○
	170	9	10	U641	ISI	FU1388-K2	-	○	
	170	9	10	U801	ISI	FU1388-K0	-	○	
	170	10,5	11	31BF /70 A305	SPNC	GS2082-F0	-	○	
	170,1	5,9	6,3	PTFE B602 /NBR	OMS-MR	24331789	-		○
	170,1	5,9	6,3	PTFE C104 /NBR	OMS-MR	49018755	-		○
155	170,1	5,9	6,3	PTFE GM201 /NBR	OMS-MR	24343181	-		○
	170,1	5,9	6,3	PTFE C104 /NBR	OMS-MR PR	49018944	-		○
	175	14,6	16	95 AU V142	T 20	49019096	-		○
	175	15	16	70 NBR B209	S 8	24007685	IP		●
	180	19	20	94 U801	IDI	FU1393-F0	-	○	
	180	20	21	94 U801	IDI	FU2181-F0	-	○	
	185	15	16	90 NBR 109	N 1	17131	-		○
156,5	171,6	5,9	6,3	PTFE GM201 /NBR	OMS-MR	24234934	-		○
157	172,1	5,9	6,3	PTFE B602 /NBR	OMS-MR	24359536	-		○
158	178	9,4	10	PTFE GM201	OMS-S	24234939	-		○
158,8	177,8	12,3	13,5	95 AU V142	T 20	24315962	-		○
	190,8	127,5	127,5	BHNR B5A151	V 1000	24103260	-		○
	175	9	10	U641	ISI	FU1406-K1	-	○	
	175	9	10	U801	ISI	FU1406-K0	-	○	
	175	9	10	A505	IUH	CU1406-N1	-	○	
	175	10	11	94 U801	IDI	FU1407-F0	-	○	
	175	10,5	11	31BF /70 A305	SPNC	GS2083-F0	-	○	
160	175	14,6	16	95 AU V142	T 20	24374166	-		○
	175	14,6	16	95 AU V157	TM 23	24308961	-		○
	175	15	16	95 AU V142	NRS-0503	24249242	-		○
	175,1	5,9	6,3	PTFE 55YF /70 A305	HBTS	GS5073-V6	-	○	
	175,1	5,9	6,3	PTFE B602 /NBR	OMS-MR	24179241	IP		●
	175,1	5,9	6,3	PTFE B602 /FKM	OMS-MR	24269037	-		○
	175,1	5,9	6,3	PTFE GM201 /NBR	OMS-MR	24131220	-		○

d [mm]	D [mm]	H [mm]	L [mm]	Material	Design	Part No.	PU ¹⁾	US	EU
160	175,1	5,9	6,3	PTFE B602 / NBR	OMS-MR PR	49015918	IP		●
	175,1	5,9	6,3	PTFE C104 / NBR	OMS-MR PR	49017743	-		○
	175,1	5,9	6,3	95 AU V142	SYPRIM SM	49307657	IP		●
	175,5	6	6,3	U641 / 12NM	HBV	FG0433-F5	-	○	
	175,5	6	6,3	U801 / 12NM	HBV	FG0433-F4	-	○	
	175,5	6	6,3	UH05 / 12NM	HBV	FG0433-F6	-	○	
	180	9,4	10	PTFE B602	OMS-S	24375281	-		○
	180	9,4	10	PTFE B602	OMS-S	49037271	-		○
	180	9,4	10	PTFE GM201	OMS-S	24096146	-		○
	180	9,4	10	PTFE GM201	OMS-S	24367093	IP		●
	180	9,4	10	PTFE B602	OMS-S PR	24376115	-		○
	180	9,8	10	19YF / A305	SPNO	GS2834-V0	-	○	
	180	12	13	94 U801	IDI	FU1409-F0	-	○	
	180	14	15	90 NBR 109	N 1	17137 40421517	IP SP		● ●
	180	14,6	16	94 AU 30000	T 20	49334420	-		○
	180	14,6	16	95 AU V142	T 20	24266878 40422383	IP SP		● ●
	180	14,6	16	93 AU V167	TMP 20	24371779	-		○
	180	15	16	94 AU 925	AUN 100	14320 40421196	IP SP		● ●
	180	15	16	90 NBR 109	N 100	15937 40421335	IP SP		● ●
	180	15	16	94 AU 30000	NI 300	49334508	-		○
	180	15	16	94 AU 925	NI 300	21538 40421658	IP SP		● ●
	180	15	16	70 NBR B209	S 8	24027656	IP		●
	180	16	17	94 U801	IDI	FU1412-F0	-	○	
	180	17,3	19	95 AU V142	T 20	24362611	-		○
	180	40	40	BHFKM B4K674	ESV	24139064	-		○
	185	14,6	16	95 AU V142	NRS-0503	24360091	-		○
	185	14,6	16	95 AU V142	T 20	24223326 40422277 8004-223.326	IP SP -	○	● ●
	185	14,6	16	95 AU V142	T 22	24250873	-		○
	185	15	16	90 NBR 109	N 1	17138	-		○
	185	15	16	94 AU 925	NI 300	401896 40421953	IP SP		● ●
	185	15	16	80 NBR 878	NI 400	4496	-		○
	185	16	17	94 U801	IDI	FU1414-F0	-	○	
	185	19	20	94 U801	IDI	FU2076-F0	-	○	
	185	20	21	94 U801	IDI	FU1416-F0	-	○	
	185	40	40	BHNBR B4B246	ES	24220069	IP		●
	185	40	40	BHFKM B4K674	ESV	24220031	IP		●
	190	15	16	90 NBR 109	N 1	17135	-		○
	190	17,3	19	95 AU V142	T 20	530551	-		○
	190	22	23	85 NBR B247	L 20	24096780	-		○
	190	22	23	90 NBR 109	N 100	17675	-		○
	190	45	45	BHNBR B4B246	ES	24061737	-		○
	190	45	45	BHFKM B4K674	ESV	24220032	-		○
190	50	50	BHFKM B4K674	ESV	24220033	-		○	
190	60	60	BHNBR B4B246	ES	24070238	IP		●	
190	60	60	BHNBR B4B246	ES	24087331	-		○	

d [mm]	D [mm]	H [mm]	L [mm]	Material	Design	Part No.	PU ¹⁾	US	EU
160	190	60	60	BHFKM B4K674	ESV	24107183	IP		●
	190	67	67	MAHPT C9T003	DMS	24293276	-		○
	190	95	95	BHNBR B5B210	V 1000	24074695	-		○
	190	95	95	BHNBR B5B210	V 1000	24095014	-		○
	190	95	95	BHNR B5A151	V 1000	24102041	-		○
	190	95	95	BHNR B5A151	V 1000	24178280	-		○
	190	97	97	BHNBR B5B210	V 1000	24100394	-		○
	190	120	120	BHNBR B5B210	V 1000	24076192	-		○
	190	120	120	BHNBR B5B210	V 1000	24083991	-		○
	190	122	122	BHNBR B5B210	V 1000	24076149	-		○
	190	122	122	BHNR B5A151	V 1000	24095656	-		○
	190	128	128	BHNR B5A151	V 1000	24231977	-		○
	190	145	145	BHNBR B5B210	V 1000	24127917	-		○
	192	120	120	BHNR B5A151	V 1000	24101219	-		○
	200	17	3	88 NBR 101	H MF	10442 40421076 1044211	IP SP -		● ●
165	180	9	10	U641	ISI	FU1429-K1	-	○	
	180	9	10	U801	ISI	FU1429-K0	-	○	
	180	10,5	11	31BF/70 A305	SPNC	GS2084-F0	-	○	
	180	14,6	16	95 AU V142	T 20	24363184	-		○
	180,1	5,9	6,3	PTFE B602/NBR	OMS-MR	24329893	-		○
	180,1	5,9	6,3	PTFE B602/FKM	OMS-MR	24331858	-		○
	180,1	5,9	6,3	PTFE B602/NBR	OMS-MR	49008556	-		○
	180,1	5,9	6,3	PTFE GM201 /FKM	OMS-MR	24245338	-		○
	180,1	5,9	6,3	PTFE GM201 /NBR	OMS-MR	49061412	-		○
	182	14,6	16	93 AU V167	TM 23	24366938	-		○
	185	9,4	10	PTFE GM201	OMS-S	49039714	-		○
	185	14,6	16	95 AU V142	T 20	24370604	-		○
	185	15	16	70 NBR B209	S 8	24007694	IP		●
	195	15	16	90 NBR 109	N 1	17139	-		○
	195	26	27	94 AU 925	AUN 1	103810	-		○
195	99	99	BHNBR B5B210	V 1000	24178047	-		○	
200	121,5	121,5	BHNBR B5B210	V 1000	24144903	-		○	
165,1	197,1	129,6	129,6	BHNR B5A151	V 1000	24093302	-		○
166	206	112	112	BHNR B6A151	V 1000	527301	-		○
167	182,1	5,9	6,3	PTFE B602/NBR	OMS-MR	531319	-		○
168	198	124	124	BHNBR B5B210	V 1000	24338674	-		○
170	185	9	10	U641	ISI	FU1443-K2	-	○	
	185	9	10	U801	ISI	FU1443-K0	-	○	
	185	10	11	94 U801	IDI	FU1444-F0	-	○	
	185	10,5	11	31BF/70 A305	SPNC	GS2085-F0	-	○	
	185	14,6	16	95 AU V142	T 23	24306416	IP		●
	185	14,6	16	93 AU V167	TM 23	24292396	-		○
	185,1	5,9	6,3	PTFE 55YF/70 A305	HBTS	GS5074-V6	-	○	
	185,1	5,9	6,3	PTFE B602/NBR	OMS-MR	24214082	IP		●
	185,1	5,9	6,3	PTFE B602/FKM	OMS-MR	24249007	IP		●
	185,1	5,9	6,3	PTFE C104/NBR	OMS-MR	49018756	-		○
	185,1	5,9	6,3	PTFE GM201 /NBR	OMS-MR	24133133	-		○
	185,1	5,9	6,3	PTFE B602/NBR	OMS-MR PR	49022317	-		○
	185,1	5,9	6,3	PTFE C104/NBR	OMS-MR PR	49018943	-		○

d [mm]	D [mm]	H [mm]	L [mm]	Material	Design	Part No.	PU ¹⁾	US	EU
	185,1	5,9	6,3	PTFE GM201 / NBR	OMS-MR PR	49015207	-		○
	185,1	5,9	6,3	95 AU V142	SYPRIM SM	24357331	-		○
	185,5	6	6,3	U641 / 80NP	HBV	FQ0603-F1	-	○	
	185,5	6	6,3	U801 / 80NP	HBV	FQ0603-F0	-	○	
	190	9,4	10	PTFE GM201	OMS-S	24106817	-		○
	190	9,8	10	19YF / A305	SPNO	GS2835-V0	-	○	
	190	12	13	94 U801	IDI	FU1445-F0	-	○	
	190	12	13	A505	IUH	CU3494-N1	-	○	
	190	12	13	A567	IUH	CU3494-N0	-	○	
	190	12	13	G928	IUH	CU3494-N2	-	○	
	190	14,6	16	95 AU V142	T 20	24338964 40422471	IP SP		● ●
	190	14,6	16	95 AU V142	T 23	24377490	-		○
	190	15	16	94 AU 925	NI 300	21561 40421659	IP SP		● ●
	190	15	16	70 NBR B209	S 8	24091141	IP		●
170	190	16	17	94 U801	IDI	FU1447-F0	-	○	
	195	16	17	94 U801	IDI	FU1449-F0	-	○	
	195	18,5	20	80 NBR B246	Seal Set O214	24299328	-		○
	195	20	21	94 U801	IDI	FU1450-F0	-	○	
	200	12	3	88 NBR 101	H MF	10448	-		○
	200	15	16	90 NBR 109	N 1	17143 40421518	IP SP		● ●
	200	18	19	80 NBR 878	NI 400	3624	-		○
	200	20,9	23	93 AU V167	TMP 20	24368238	-		○
	200	22	23	90 NBR 109	N 100	17721 40421539	IP SP		● ●
	200	22	23	80 NBR B246	Seal Set O214	24294436	-		○
	200	22	23	80 NBR B246	Seal Set O216	24275197	-		○
	200	26	27	94 AU 925	AUN 1	103812	-		○
	200	99	99	BHNR B5B210	V 1000	24124025	-		○
	200	99	99	BHNR B5A151	V 1000	24268170	-		○
	210	20	21	90 NBR 109	N 1	17142	-		○
171	179	10,9	12	95 AU V142	T 24	24308893	-		○
171,5	196,9	126,9	126,9	BHNR B5A151	V 1000	24105616	-		○
173	188,1	5,9	6,3	PTFE B602 / NBR	OMS-MR	24327394	-		○
	20	19	20	94 U801	IDI	FU1463-F0	-	○	
	20	20	21	94 U801	IDI	FU2182-F0	-	○	
	190	9	10	U641	ISI	FU1459-K1	-	○	
	190	9	10	U801	ISI	FU1459-K0	-	○	
	190	10,5	11	31BF / 70 A305	SPNC	GS2086-F0	-	○	
	190,1	5,9	6,3	PTFE B602 / NBR	OMS-MR	24379243	-		○
175	190,1	5,9	6,3	PTFE B602 / NBR	OMS-MR PR	49035947	-		○
	195	9,4	10	PTFE GM201	OMS-S	24187339	-		○
	195	14,6	16	95 AU V142	T 20	49030797	IP		●
	205	15	16	90 NBR 109	N 1	17145	-		○
	205	100	100	BHNR B5B210	V 1000	24329556	-		○
	205	125	125	BHNR B5B210	V 1000	24086139	-		○
	210	139,5	139,5	BHNR B5A151	V 1000	529575	-		○
176,5	191,6	5,9	6,3	PTFE B602 / NBR	OMS-MR	24359537	-		○
177	192,1	5,9	6,3	PTFE B602 / NBR	OMS-MR	24380430	-		○
177,8	192,9	6,3	6,3	PTFE B602 / NBR	OMS-MR	24307537	-		○

d [mm]	D [mm]	H [mm]	L [mm]	Material	Design	Part No.	PU ¹⁾	US	EU
178	210	129,6	129,6	BHNR B5A151	V 1000	24227002	-		○
180	20	9,8	10	19YF/A305	SPNO	GS2836-V0	-	○	
	20	12	13	U641	ISI	FU1483-K1	-	○	
	20	12	13	U801	ISI	FU1483-K0	-	○	
	20	12	13	A505	IUH	CU1483-N2	-	○	
	20	12	13	A567	IUH	CU1483-N3	-	○	
	20	16	17	94 U801	IDI	FU1486-F0	-	○	
	195	10,5	11	31BF/70 A305	SPNC	GS2087-F0	-	○	
	195	11,4	12,5	95 AU V142	T 23	24377491	-		○
	195	14,6	16	93 AU V167	TM 23	24299882	-		○
	195,1	5,9	6,3	PTFE 55YF/70 A305	HBTS	GS5075-V6	-	○	
	195,1	5,9	6,3	PTFE B602/NBR	OMS-MR	24179242	IP		●
	195,1	5,9	6,3	PTFE B602/FKM	OMS-MR	24316384	IP		●
	195,1	5,9	6,3	PTFE C104/NBR	OMS-MR	49018757	-		○
	195,1	5,9	6,3	PTFE C104/FKM	OMS-MR	49024868	-		○
	195,1	5,9	6,3	PTFE GM201/NBR	OMS-MR	24131221	IP		●
	195,1	5,9	6,3	PTFE GM201/FKM	OMS-MR	24239005	-		○
	195,1	5,9	6,3	PTFE B602/NBR	OMS-MR PR	49015919	IP		●
	195,1	5,9	6,3	PTFE C104/NBR	OMS-MR PR	49017744	-		○
	195,1	5,9	6,3	PTFE GM201/FKM	OMS-MR PR	49012616	-		○
	195,1	5,9	6,3	PTFE GM201/NBR	OMS-MR PR	49023809	IP		●
	195,1	5,9	6,3	95 AU V142	SYPRIM SM	24357332	-		○
	195,5	6	6,3	U641/80NP	HBV	FQ0451-F1	-	○	
	195,5	6	6,3	U801/80NP	HBV	FQ0451-F0	-	○	
	195,5	6	6,3	UH05/80NP	HBV	FQ0451-F3	-	○	
	200	9,4	10	PTFE GM201	OMS-S	24096147	IP		●
	200	9,4	10	PTFE GM201	OMS-S	24367094	IP		●
	200	9,4	10	PTFE B602	OMS-S PR	24376116	-		○
	200	9,4	10	PTFE GM201	OMS-S PR	532693	-		○
	200	9,4	10	PTFE GM201	OSES-0277	49012624	-		○
	200	10	11	90 NBR 109	N 1	17151 40421519	IP SP	○	● ●
	200	11,8	13	95 AU V142	T 20	24374656	-		○
	200	14,6	16	94 AU 30000	T 20	49334421	-		○
	200	14,6	16	95 AU V142	T 20	24223327 40422278 8004-223.327	IP SP -	○	● ●
200	14,6	16	93 AU V167	TM 23	24374346	-		○	
200	14,7	16	92 AU 21100	HDR-2C	49310895	IP		●	
200	15	16	94 AU 925	AUN 100	103817 40421848	IP SP		● ●	
200	15	16	94 AU 30000	NI 300	49334509	-		○	
200	15	16	94 AU 925	NI 300	18793 40421600	IP SP	○	● ●	
200	15	16	70 NBR B209	S 8	24007703	IP		●	
200	18	19	94 AU 925	AUN 1	103815	-		○	
200	19,1	21	95 AU V142	T 23	24332132	IP		●	
200	19,1	21	93 AU V167	TM 23	24293702	-		○	
200	40	40	BHFKM B4K674	ESV	24143887	-		○	
204	12	13	90 NBR 109	N 1	17149	-		○	
205	14,6	16	95 AU V142	T 20	24223328 40422279	IP SP		● ●	

d [mm]	D [mm]	H [mm]	L [mm]	Material	Design	Part No.	PU ¹⁾	US	EU
	205	15	16	94 AU 925	NI 300	401907	-		○
	205	15	16	80 NBR 878	NI 400	4503	-		○
	205	16	17	94 U801	IDI	FU1491-F0	-	○	
	205	18,2	20	95 AU V142	T 20	24380944	-		○
	205	18,8	20	70 NBR B209	S 8	24120564	-		○
	205	19	20	94 U801	IDI	FU1492-F0	-	○	
	205	20	21	94 U801	IDI	FU1493-F0	-	○	
	205	40	40	BHNBR B4B246	ES	24220071	IP		●
	205	40	40	BHFKM B4K674	ESV	24220034	-		○
	210	15	16	90 NBR 109	N 1	17150	-		○
	210	17,3	19	95 AU V142	T 20	24375978 8004-375.978	-	○	○
	210	18	19	94 AU 925	NI 300	21569	-		○
	210	18	19	80 NBR B246	Seal Set O214	24245484	-		○
	210	18	19	80 NBR B246	Seal Set O216	24245114	-		○
	210	20,9	23	93 AU V167	TMP 20	24368239	-		○
	210	22	23	90 NBR 109	N 100	17708	-	○	○
180	210	22	23	80 NBR B246	Seal Set O214	24315582	-		○
	210	22,8	25	95 AU V142	T 20	24359904	-		○
	210	45	45	BHNBR B4B246	ES	24061739	IP		●
	210	45	45	BHFKM B4K674	ESV	24149739	-		○
	210	50	50	BHNBR B4B246	ES	24131959	IP		●
	210	50	50	BHFKM B4K674	ESV	24220035	-		○
	210	60	60	BHNBR B4B246	ES	24070239	IP		●
	210	60	60	BHFKM B4K674	ESV	24139298	IP		●
	210	95	95	BHNBR B5B210	V 1000	24073936	-		○
	210	95	95	BHNBR B5B210	V 1000	24102039	-		○
	210	120	120	BHNBR B5B210	V 1000	24079395	-		○
	210	120	120	BHNBR B5B210	V 1000	24118649	-		○
	210	120	120	BHNR B5A151	V 1000	24086603	-		○
	210	125	125	BHNR B5A151	V 1000	24351234	-		○
	210	128	128	BHNR B5A151	V 1000	24095183	-		○
	212	14	4	88 NBR 101	H MF	10458 40421077	IP SP		● ●
	220	20	21	94 AU 925	AUN 1	103813	-		○
	20	10,5	11	31BF/70 A305	SPNC	GS2088-F0	-	○	
185	200	11,4	12,5	95 AU V142	T 20	24373150	-		○
	200	20,6	23	93 AU V167	TM 23	24374555	-		○
	200,1	5,9	6,3	PTFE B602/NBR	OMS-MR	24335093	-		○
	200,1	5,9	6,3	PTFE GM201/NBR	OMS-MR	24292413	-		○
	215	125	125	BHNR B5A151	V 1000	24144468	-		○
185,5	200,6	5,9	6,3	PTFE B602/FKM	OMS-MR	24373690	-		○
187	227	144	144	BHNBR B6B210	V 1000	24310517	-		○
189	204,1	5,9	6,3	PTFE B602/NBR	OMS-MR	49002206	-		○
	205	10,5	11	31BF/70 A305	SPNC	GS2089-F0	-	○	
	205	15	16	95 AU V142	NRS-0503	24187259	-		○
190	205,1	5,9	6,3	PTFE B602/NBR	OMS-MR	24223168	IP		●
	205,1	5,9	6,3	PTFE B602/FKM	OMS-MR	24348307	IP		●
	205,1	5,9	6,3	PTFE C104/NBR	OMS-MR	49035942	IP		●
	205,1	5,9	6,3	PTFE GM201/NBR	OMS-MR	24216295	-		○
	205,1	5,9	6,3	PTFE B602/NBR	OMS-MR PR	49018778	-		○

d [mm]	D [mm]	H [mm]	L [mm]	Material	Design	Part No.	PU ¹⁾	US	EU
	205,1	5,9	6,3	PTFE C104 / NBR	OMS-MR PR	49043085	IP		●
	205,1	5,9	6,3	PTFE GM201 / NBR	OMS-MR PR	49023810	IP		●
	205,5	6	6,3	U641 / 80NP	HBV	FQ0646F1	-	○	
	205,5	6	6,3	U801 / 80NP	HBV	FQ0646F0	-	○	
	210	9,4	10	PTFE GM201	OMS-S PR	49003726	-		○
	210	9,8	10	19YF / A305	SPNO	GS2837-V0	-	○	
	210	12	13	U641	ISI	FU1516K1	-	○	
	210	12	13	U801	ISI	FU1516K0	-	○	
	210	13,7	15	95 AU V142	T 20	24368634	-		○
	210	14,6	16	95 AU V142	T 20	24328527 40422461	IP SP		● ●
	210	14,6	16	93 AU V167	TM 23	24265473	-		○
	210	15	16	94 AU 925	AUN 100	103821 40421849	IP SP		● ●
	210	16	17	94 U801	IDI	FU1518-F0	-	○	
	210,5	7,6	8,1	PTFE GM201 / NBR	OMS-MR	24361227	-		○
190	215	15	3	88 NBR 101	H MF	10463	-		○
	215	16	17	94 U801	IDI	FU1520-F0	-	○	
	215	16	17	A505	IUH	CU3523-N0	-	○	
	215	16	17	A567	IUH	CU3523-N2	-	○	
	215	17,1	18,8	95 AU V142	T 20	24370226	-		○
	215	20	21	94 U801	IDI	FU1521-F0	-	○	
	220	15	16	90 NBR 109	N 1	17158	-		○
	220	22	23	90 NBR 109	N 100	17736	-		○
	220	22	23	80 NBR B246	Seal Set 0214	24262669	-		○
	220	60,5	60,5	BHFKM B4K674	ESV	533505	-		○
	220	100	100	BHNBR B5B210	V 1000	531927	-		○
	220	100	100	BHNBR B5B210	V 1000	24086909	-		○
	220	117,4	117,4	BHNBR B5B210	V 1000	24064507	-		○
	220	120	120	BHNBR B5B210	V 1000	24144248	-		○
	220	120	120	BHNR B5A151	V 1000	24095430	-		○
	230	112	112	BHNBR B6B210	V 1000	24074444	-		○
	230	121	121	BHNBR B6B210	V 1000	24374261	-		○
	210	10,5	11	31BF / 70 A305	SPNC	GS2090-F0	-	○	
	210	14,6	16	93 AU V167	TM 23	24356464	-		○
195	210,1	5,9	6,3	PTFE C104 / NBR	OMS-MR	49038139	-		○
	215	14,6	16	93 AU V167	TM 23	24366936	-		○
	225	15	16	90 NBR 109	N 1	17161	-		○
	235	112	112	BHNBR B6B210	V 1000	24369737	-		○
196,9	228,6	121	121	BHNR B5A151	V 1000	24175026	-		○
	235	98,5	98,5	BHNBR B6B210	V 1000	24334696	-		○
	219	11	12	94 U801	IDI	FU1530-F0	-	○	
199	219	15	16	94 U801	IDI	FU1531-F0	-	○	
	224	16	17	94 U801	IDI	FU1533-F0	-	○	
	224	19	20	94 U801	IDI	FU1535-F0	-	○	
	215	10,5	11	31BF / 70 A305	SPNC	GS2091-F0	-	○	
	215	11,4	12,5	95 AU V142	T 20	24339703	-		○
200	215,1	5,9	6,3	PTFE GM201 / FKM	OMS-MR	24245583	-		○
	220	9,4	10	PTFE B602	OMS-S	525585	-		○
	220	9,4	10	PTFE B602	OMS-S	24352639	-		○
	220	9,4	10	PTFE GM201	OMS-S	24096148	IP		●

d [mm]	D [mm]	H [mm]	L [mm]	Material	Design	Part No.	PU ¹⁾	US	EU
200	220	9,4	10	PTFE GM201	OMS-S	24222590	IP		●
	220	9,4	10	PTFE B602	OMS-S PR	531597	-		○
	220	9,4	10	PTFE GM201	OMS-S PR	49013967	-		○
	220	9,8	10	19YF/A305	SPNO	GS2838-V0	-	○	
	220	12	13	U641	ISI	FU1543-K1	-	○	
	220	12	13	U801	ISI	FU1543-K0	-	○	
	220	14,6	16	94 AU 30000	T 20	49334422	-		○
	220	14,6	16	95 AU V142	T 20	24223329 40422280	IP SP		● ●
	220	15	16	70 NBR B209	S 8	24007710	IP		●
	220	16	17	94 U801	IDI	FU1545-F0	-	○	
	220,5	7,6	8,1	PTFE B602/NBR	OMS-MR	24179243	IP		●
	220,5	7,6	8,1	PTFE B602/FKM	OMS-MR	24258145	IP		●
	220,5	7,6	8,1	PTFE C104/NBR	OMS-MR	49037711	-		○
	220,5	7,6	8,1	PTFE GM201/NBR	OMS-MR	24131222	-		○
	220,5	7,6	8,1	PTFE GM201/FKM	OMS-MR	24238628	-		○
	220,5	7,6	8,1	PTFE B602/NBR	OMS-MR PR	49027562	-		○
	220,5	7,6	8,1	PTFE C104/NBR	OMS-MR PR	49017745	-		○
	220,5	7,6	8,1	PTFE GM201/FKM	OMS-MR PR	49013960	-		○
	220,5	7,6	8,1	PTFE GM201/NBR	OMS-MR PR	49023811	IP		●
	220,5	7,6	8,1	95 AU V142	SYPRIM SM	24357333	-		○
	221	7,7	8	U641/80NP	HBV	FG0830-F2	-	○	
	221	7,7	8	U801/80NP	HBV	FG0830-F0	-	○	
	221	7,7	8	UH05/80NP	HBV	FG0830-F3	-	○	
	225	11,7	12,5	PTFE GM201	OMS-S	49000277	-		○
	225	14,6	16	95 AU V142	T 20	24223330 40422281	IP SP		● ●
	225	15	16	80 NBR 878	NI 400	4506	-		○
	225	16	17	94 U801	IDI	FU1548-F0	-	○	
	225	16	17	A505	IUH	CU1548-N1	-	○	
	225	18,2	20	95 AU V142	T 20	24380945	-		○
	225	19	20	94 U801	IDI	FU2135-F0	-	○	
	225	20	21	94 U801	IDI	FU1550-F0	-	○	
	225	40	40	BHNBR B4B246	ES	24220072	IP		●
	230	15	3	88 NBR 101	H MF	10471	-		○
	230	15	16	94 AU 925	AUN 1	103825	-		○
	230	15	16	90 NBR 109	N 1	17166	-		○
	230	22	23	85 NBR B247	L 20	24096782	-		○
	230	22	23	90 NBR 109	N 100	17813	-		○
	230	22	23	80 NBR B246	Seal Set 0216	24290483	-		○
	230	28	30	95 AU V142	NRS-0503	49045084	-		○
	230	45	45	BHNBR B4B246	ES	24064261	-		○
	230	45	45	BIFKM B4K674	ESV	24173014	-		○
	230	50	50	BHNBR B4B246	ES	24076302	IP		●
230	50	50	BIFKM B4K674	ESV	24220037	-		○	
230	50,5	50,5	BHNBR B4B246	ES	24218873	-		○	
230	50,5	50,5	BHNBR B4B246	ES	24219156	-		○	
230	51,5	50	BHNBR B4B246	ES	24145843	-		○	
230	52	50,5	BHNBR B4B246	ES	24218713	-		○	
230	60	60	BHNBR B4B246	ES	24070240	IP		●	
230	60	60	BHNBR B4B246	ES	24079136	-		○	

d [mm]	D [mm]	H [mm]	L [mm]	Material	Design	Part No.	PU ¹⁾	US	EU
	230	60	60	BHNBR B4B246	ES	24135050	-		○
	230	60	60	BHFKM B4K674	ESV	24107185	IP		●
	230	61,5	60	BHNBR B4B246	ES	24146349	-		○
	230	95	95	BHNBR B5B210	V 1000	24067511	-		○
	230	95	95	BHNBR B5B210	V 1000	24080361	-		○
	230	95	95	BHNBR B5B210	V 1000	24102583	-		○
	230	95	95	BHNR B5A151	V 1000	24117878	-		○
	230	100	100	BHNBR B5B210	V 1000	24079821	-		○
200	230	120	120	BHNBR B5B210	V 1000	24077338	-		○
	230	120	120	BHNBR B5B210	V 1000	24085551	-		○
	230	120	120	BHNBR B5B210	V 1000	24134983	-		○
	230	120	120	BHNR B5A151	V 1000	24103378	-		○
	230	125	125	BHNR B5A151	V 1000	24187569	-		○
	230	145	145	BHNR B5A151	V 1000	24312077	-		○
	240	15	3	88 NBR 101	H MF	10469	-		○
	240	20	21	90 NBR 109	N 1	17167	-		○
	240	112	112	BHNBR B6B210	V 1000	24118009	-		○
	240	144	144	BHNR B6A151	V 1000	24173300	-		○
204	224	12	13	U641	ISI	FU1563-K1	-	○	
	224	12	13	U801	ISI	FU1563-K0	-	○	
	220	10,5	11	31BF/70 A305	SPNC	GS2092-F0	-	○	
205	225,5	7,6	8,1	PTFE B602/NBR	OMS-MR	24335733	-		○
	225,5	7,6	8,1	PTFE GM201/NBR	OMS-MR	24335588	-		○
	225,5	7,6	8,1	PTFE C104/NBR	OMS-MR PR	49042766	-		○
	230	15	16	90 NBR 109	N 1	17172	-		○
	235	21,8	24	95 AU V142	T 20	24361564	-		○
209	224	10,5	11	31BF/70 A305	SPNC	GS2093-F0	-	○	
	225	10,5	11	31BF/70 A305	SPNC	GS2094-F0	-	○	
	230	9,8	10	19YF/A305	SPNO	GS2839-V0	-	○	
	230	12	13	U641	ISI	FU1575-K1	-	○	
	230	12	13	U801	ISI	FU1575-K0	-	○	
	230	14,6	16	95 AU V142	T 20	24337781	-		○
	230	14,6	16	93 AU V167	TM 23	24358106	-		○
	230	16	17	94 U801	IDI	FU1576-F0	-	○	
	230	16	17	70 NBR B209	S 8	24065708	IP		●
	230,5	7,6	8,1	PTFE B602/NBR	OMS-MR	24223171	IP		●
	230,5	7,6	8,1	PTFE B602/FKM	OMS-MR	24344732	-		○
	230,5	7,6	8,1	PTFE GM201/NBR	OMS-MR	24121485	-		○
210	230,5	7,6	8,1	PTFE B602/NBR	OMS-MR PR	49027563	IP		●
	230,5	7,6	8,1	PTFE C104/NBR	OMS-MR PR	49015913	-		○
	230,5	7,6	8,1	PTFE GM201/NBR	OMS-MR PR	49023822	IP		●
	231	7,7	8	U641/80NP	HBV	FQ0824-F2	-	○	
	231	7,7	8	U801/80NP	HBV	FQ0824-F0	-	○	
	231	7,7	8	UH05/80NP	HBV	FQ0824-F3	-	○	
	235	11,7	12,5	PTFE GM201	OMS-S	24374728	-		○
	235	16	17	94 U801	IDI	FU1578-F0	-	○	
	235	16	17	A505	IUH	CU3640-N0	-	○	
	235	19	20	94 U801	IDI	FU1580-F0	-	○	
	235	20	21	94 U801	IDI	FU1581-F0	-	○	
	240	20	21	90 NBR 109	N 1	17178	-		○

d [mm]	D [mm]	H [mm]	L [mm]	Material	Design	Part No.	PU ¹⁾	US	EU
210	240	20,9	23	93 AU V167	TMP 20	24368242	-		○
	240	22	23	80 NBR B246	Seal Set O214	24251000	-		○
	240	22	23	80 NBR B246	Seal Set O216	24275209	-		○
	240	120	120	BHNBR B5B210	V 1000	24295938	-		○
	240	125	125	BHNBR B5B210	V 1000	24145442	-		○
	250	20	21	90 NBR 109	N 1	17177	-		○
	250	34	35	94 AU 925	AUN 1	103831	-		○
	250	112	112	BHNBR B6B210	V 1000	24186699	-		○
215	230	10,5	11	31BF/70 A305	SPNC	GS2095-F0	-	○	
	235	14,6	16	95 AU V142	T 20	24356092	-		○
	235	14,6	16	95 AU V142	T 20	49030353	IP		●
	235,5	7,6	8,1	PTFE B602/FKM	OMS-MR	24350016	-		○
	235,5	7,6	8,1	PTFE B602/NBR	OMS-MR	24355466	-		○
	235,5	7,6	8,1	PTFE C104/NBR	OMS-MR PR	49023880	IP		●
	240	18,2	20	95 AU V142	T 20	24372392	-		○
	245	20,9	23	95 AU V142	T 20	24362845	-		○
215,9	236,4	7,6	8,1	PTFE B602/NBR	OMS-MR	24307567	-		○
	236,4	7,6	8,1	PTFE GM201/NBR	OMS-MR	24307699	-		○
220	235	10,5	11	31BF/70 A305	SPNC	GS2096-F0	-	○	
	235	14,6	16	93 AU V167	TM 23	24262955	-		○
	240	9,8	10	19YF/A305	SPNO	GS2840-V0	-	○	
	240	12	13	U641	ISI	FU1596-K1	-	○	
	240	12	13	U801	ISI	FU1596-K0	-	○	
	240	14,6	16	94 AU 30000	T 20	49334423	-		○
	240	14,6	16	95 AU V142	T 20	24223331 40422282	IP SP		● ●
	240	15	16	94 AU 925	NI 300	21576	IP		●
	240	15	16	70 NBR B209	S 8	24139773	IP		●
	240	16	17	94 U801	IDI	FU1597-F0	-	○	
	240,5	7,6	8,1	PTFE B602/NBR	OMS-MR	24214085	IP		●
	240,5	7,6	8,1	PTFE B602/FKM	OMS-MR	24340955	IP		●
	240,5	7,6	8,1	PTFE C104/NBR	OMS-MR	49016409	IP		●
	240,5	7,6	8,1	PTFE GM201/NBR	OMS-MR	24223690	-		○
	240,5	7,6	8,1	PTFE B602/NBR	OMS-MR PR	49012807	IP		●
	240,5	7,6	8,1	PTFE B604/NBR	OMS-MR PR	49036674	-		○
	240,5	7,6	8,1	PTFE C104/NBR	OMS-MR PR	49017746	-		○
	245	11,7	12,5	PTFE B602	OMS-S	24378030	-		○
	245	11,7	12,5	PTFE B602	OMS-S	49037270	-		○
	245	11,7	12,5	PTFE GM201	OMS-S	24147048	-		○
	245	15	16	80 NBR 878	NI 400	4515	-		○
	245	16	17	94 U801	IDI	FU1598-F0	-	○	
	245	16	17	A505	IUH	CU3630-N0	-	○	
	245	16	17	G928	IUH	CU3630-N1	-	○	
	245	19	20	94 U801	IDI	FU1600-F0	-	○	
	245	20	21	94 U801	IDI	FU1601-F0	-	○	
	250	15	16	90 NBR 109	N 1	17188	-		○
	250	17,3	19	95 AU V142	T 20	24223332 40422283	IP SP		● ●
	250	18	19	80 NBR 878	NI 400	4516	-		○
	250	18,2	20	95 AU V142	T 20	24375979	-		○

d [mm]	D [mm]	H [mm]	L [mm]	Material	Design	Part No.	PU ¹⁾	US	EU
	250	19	20	80 NBR B246	Seal Set O214	24245485	-		○
	250	20,9	23	93 AU V167	TMP 20	24368243	-		○
	250	21,8	24	95 AU V142	T 20	24367393	-		○
	250	22,8	25	95 AU V142	T 20	24380946	-		○
	250	26	27	94 AU 925	AUN 1	103834	-		○
	250	50	50	BHNBR B4B246	ES	24061745	IP		●
	250	50,5	50,5	BHNBR B4B246	ES	24114136	-		○
	250	50,5	50,5	BHNBR B4B246	ES	24219165	-		○
	250	52	50,5	BHNBR B4B246	ES	24218512	-		○
	250	52	50,5	BHNBR B4B246	ES	24218722	-		○
	250	60	60	BHNBR B4B246	ES	24063737	IP		●
	250	60	60	BHNBR B4B246	ES	24218891	-		○
220	250	61,5	60	BHNBR B4B246	ES	24100511	-		○
	250	61,5	60	BHNBR B4B246	ES	24114159	-		○
	250	93	93	BHNBR B5B210	V 1000	24079077	-		○
	250	95	95	BHNBR B5B210	V 1000	24084438	-		○
	250	100	100	BHNBR B5B210	V 1000	24101261	-		○
	250	100	100	BHNR B5A151	V 1000	24104945	-		○
	250	120	120	BHNBR B5B210	V 1000	24079173	-		○
	250	125	125	BHNR B5A151	V 1000	24093699	-		○
	250	150	150	BHNBR B5B210	V 1000	525566	-		○
	260	113	113	BHNBR B6B210	V 1000	24250470	-		○
	260	160	160	BHNR B6A151	V 1000	24134773	-		○
	265	144	144	BHNR B6A151	V 1000	24342198	-		○
	270	15	3	88 NBR 101	H MF	10480	-		○
	270	190	190	BHNBR B6B210	V 1000	24180261	-		○
221,4	246,4	11,7	12,5	PTFE GM201	OMS-S	24234931	-		○
	244	9,8	10	19YF/A305	SPNO	GS2841-V0	-	○	
224	244	11	12	94 U801	IDI	FU1608-F0	-	○	
	244	15	16	94 U801	IDI	FU1610-F0	-	○	
	249	15	16	94 U801	IDI	FU1611-F0	-	○	
	249	18	19	94 U801	IDI	FU1612-F0	-	○	
	249	19	20	94 U801	IDI	FU1613-F0	-	○	
	240	10,5	11	31BF/70 A305	SPNC	GS2097-F0	-	○	
	240	15	16	70 NBR B209	S 8	24100164	-		○
	245	12	13	U641	ISI	FU1621-K1	-	○	
	245	12	13	U801	ISI	FU1621-K0	-	○	
	245	14,6	16	95 AU V142	T 20	24376131	-		○
	245	16	17	94 U801	IDI	FU1622-F0	-	○	
	245,5	7,6	8,1	PTFE B602/NBR	OMS-MR	24335734	-		○
	245,5	7,6	8,1	PTFE GM201/NBR	OMS-MR	24275173	-		○
225	250	16	17	94 U801	IDI	FU1624-F0	-	○	
	250	18	19	90 NBR 109	N 100	17976	-		○
	250	18,2	20	93 AU V167	TM 23	24366939	-		○
	250	19	20	94 U801	IDI	FU1626-F0	-	○	
	250	20	21	94 U801	IDI	FU1627-F0	-	○	
	255	15	16	90 NBR 109	N 1	17189	-		○
	255	50,5	50,5	BHNBR B4B246	ES	24100216	-		○
	255	50,5	50,5	BHNBR B4B246	ES	24218892	-		○
	255	60	60	BHNBR B4B246	ES	24067706	-		○

d [mm]	D [mm]	H [mm]	L [mm]	Material	Design	Part No.	PU ¹⁾	US	EU
225	255	60	60	BHNBR B4B246	ES	24218895	-		○
	255	61,5	60	BHNBR B4B246	ES	24064015	-		○
	255	61,5	60	BHNBR B4B246	ES	24218517	-		○
	255	125	125	BHNR B5A151	V 1000	24260720	-		○
	265	128	128	BHNBR B6B210	V 1000	24080862	-		○
	270	15	3	88 NBR 101	H MF	10484	-		○
228,6	249,1	7,6	8,1	PTFE B602/NBR	OMS-MR	24307568	-		○
	249,1	7,6	8,1	PTFE GM201/NBR	OMS-MR	24307700	-		○
	260,4	128,3	128,3	BHNBR B5B210	V 1000	24087856	-		○
245	10,5	11	31BF/70 A305	SPNC	GS2098-F0	-	○		
250	9,8	10	19YF/A305	SPNO	GS2842-V0	-	○		
250	12	13	U641	ISI	FU1637-K1	-	○		
250	12	13	U801	ISI	FU1637-K0	-	○		
250	14,6	16	95 AU V142	T 20	24223336	-		○	
250	16	17	94 U801	IDI	FU1638-F0	-	○		
230	250,5	7,6	8,1	PTFE B602/NBR	OMS-MR	24223174	IP		●
	250,5	7,6	8,1	PTFE B602/FKM	OMS-MR	24352984	-		○
	250,5	7,6	8,1	PTFE GM201/NBR	OMS-MR	24174789	-		○
	250,5	7,6	8,1	PTFE GM201/FKM	OMS-MR	24262511	-		○
	250,5	7,6	8,1	PTFE B602/NBR	OMS-MR PR	49027564	IP		●
	250,5	7,6	8,1	PTFE GM201/NBR	OMS-MR PR	49004615	-		○
	255	11,7	12,5	PTFE GM201	OMS-S	24224744	IP		●
	255	15	16	90 NBR 109	N 1	17196	-		○
	255	16	17	94 U801	IDI	FU1640-F0	-	○	
	255	19	20	94 U801	IDI	FU1642-F0	-	○	
255	20	21	94 U801	IDI	FU1643-F0	-	○		
260	22	23	90 NBR 109	N 100	17677	-		○	
260	100	100	BHNR B5A151	V 1000	24369140	-		○	
270	20	21	90 NBR 109	N 1	17194	-		○	
270	145	145	BHNR B6A151	V 1000	24097102	-		○	
235	250	10,5	11	31BF/70 A305	SPNC	GS2099-F0	-	○	
	255	14,6	16	95 AU V142	T 20	24366784	-		○
	255	14,6	16	93 AU V167	TM 23	24299884	-		○
	255,5	7,6	8,1	PTFE B602/NBR	OMS-MR	24315039	-		○
	255,5	7,6	8,1	PTFE C104/NBR	OMS-MR PR	49017635	-		○
	275	20	21	90 NBR 109	N 1	15909	-		○
237,2	262,2	11,7	12,5	PTFE GM201	OMS-S	24186690	-		○
240	255	10,5	11	31BF/70 A305	SPNC	GS2100-F0	-	○	
	260	9,8	10	19YF/A305	SPNO	GS2843-V0	-	○	
	260	12	13	U641	ISI	FU1657-K1	-	○	
	260	12	13	U801	ISI	FU1657-K0	-	○	
	260	14,6	16	95 AU V142	T 20	24290247	IP		●
	260	15	16	70 NBR B209	S 8	24091143	IP		●
	260	16	17	94 U801	IDI	FU1658-F0	-	○	
	260,5	7,6	8,1	PTFE B602/NBR	OMS-MR	24223177	IP		●
	260,5	7,6	8,1	PTFE B602/FKM	OMS-MR	24344734	IP		●
	260,5	7,6	8,1	PTFE GM201/NBR	OMS-MR	24105394	-		○
	260,5	7,6	8,1	PTFE GM201/FKM	OMS-MR	24238627	-		○
	260,5	7,6	8,1	PTFE B602/NBR	OMS-MR PR	49016866	IP		●
	260,5	7,6	8,1	PTFE C104/NBR	OMS-MR PR	49018772	-		○

d [mm]	D [mm]	H [mm]	L [mm]	Material	Design	Part No.	PU ¹⁾	US	EU
	265	11,7	12,5	PTFE GM201	OMS-S	24224748	IP		●
	265	11,7	12,5	PTFE GM201	OMS-S PR	533361	-		○
	265	16	17	94 U801	IDI	FU1661-F0	-	○	
	265	19	20	94 U801	IDI	FU1663-F0	-	○	
	265	19	20	A505	IUH	CU3335-N1	-	○	
	265	20	21	94 U801	IDI	FU1664-F0	-	○	
	270	17,3	19	95 AU V142	T 20	24352222	IP		●
	270	18	19,8	95 AU V142	T 20	24314612	-		○
	270	20,9	23	93 AU V167	TMP 20	24367642	-		○
	270	22	23	80 NBR B246	Seal Set 0214	24243972	-		○
	270	50,5	50,5	BHNBR B4B246	ES	24218903	-		○
	270	50,5	50,5	BHNBR B4B246	ES	24219174	-		○
	270	52	50,5	BHNBR B4B246	ES	24218522	-		○
240	270	52	50,5	BHNBR B4B246	ES	24218734	-		○
	270	60	60	BHNBR B4B246	ES	24061635	-		○
	270	60	60	BHNBR B4B246	ES	24177276	-		○
	270	61,5	60	BHNBR B4B246	ES	24083267	-		○
	270	61,5	60	BHNBR B4B246	ES	24083524	-		○
	270	93	93	BHNBR B5B210	V 1000	24068389	-		○
	270	95	95	BHNBR B5B210	V 1000	24083041	-		○
	270	125	125	BHNR B5A151	V 1000	24095660	-		○
	272	16	17	90 NBR 109	N 1	17197	-		○
	272	26	27	94 AU 925	AUN 1	103838	-		○
	280	20	21	90 NBR 109	N 1	11895	-		○
	280	128	128	BHNR B6A151	V 1000	24114248	-		○
	284	145	145	BHNR B6A151	V 1000	24183384	-		○
	299	20	3	88 NBR 101	H MF	10489	-		○
241,3	261,8	7,6	8,1	PTFE B602/NBR	OMS-MR	24307569	-		○
	260	10,5	11	31BF/70 A305	SPNC	GS2101-F0	-	○	
	265,5	7,6	8,1	PTFE B602/NBR	OMS-MR	24377707	-		○
245	267	14,1	15,5	95 AU V142	T 20	24362532	-		○
	270	18,2	20	93 AU V167	TM 23	24314006	-		○
	285	145	145	BHNBR B6B210	V 1000	24088927	-		○
247,7	272,7	11,7	12,5	PTFE GM201	OMS-S	24247181	-		○
	285,8	152,5	152,5	BHNR B6A151	V 1000	24250670	-		○
248	292	113	113	BHNBR B6B210	V 1000	24328802	-		○
	265	10,5	11	31BF/70 A305	SPNC	GS2102-F0	-	○	
	270	9,8	10	19YF/A305	SPNO	GS2844-V0	-	○	
	270	12	13	U641	ISI	FU1678-K1	-	○	
	270	12	13	U801	ISI	FU1678-K0	-	○	
	270	14,6	16	94 AU 30000	T 20	49334424	-		○
	270	14,6	16	95 AU V142	T 20	24291160 40422404	IP SP		● ●
250	270	16	17	94 U801	IDI	FU1679-F0	-	○	
	270,5	7,6	8,1	PTFE B602/NBR	OMS-MR	24214087	IP		●
	270,5	7,6	8,1	PTFE B602/FKM	OMS-MR	24344735	-		○
	270,5	7,6	8,1	PTFE GM201/NBR	OMS-MR	24179920	-		○
	270,5	7,6	8,1	PTFE B602/NBR	OMS-MR PR	49030568	-		○
	270,5	7,6	8,1	PTFE C104/NBR	OMS-MR PR	49017747	IP		●
	270,5	7,6	8,1	PTFE GM201/NBR	OMS-MR PR	49009053	-		○

d [mm]	D [mm]	H [mm]	L [mm]	Material	Design	Part No.	PU ¹⁾	US	EU
	275	11,7	12,5	PTFE B602	OMS-S	24301162	-		○
	275	11,7	12,5	PTFE GM201	OMS-S	24195054	-		○
	275	11,7	12,5	PTFE GM201	OMS-S PR	49004521	-		○
	275	16	17	94 U801	IDI	FU1681-F0	-	○	
	275	19	20	94 U801	IDI	FU1683-F0	-	○	
	275	20	21	94 U801	IDI	FU1684-F0	-	○	
	280	17,3	19	95 AU V142	T 20	24223333 40422284	IP SP		● ●
	280	20,9	23	95 AU V142	T 20	24373997	-		○
	280	20,9	23	93 AU V167	TMP 20	24368244	-		○
	280	22	23	80 NBR B246	Seal Set O214	24265061	-		○
	280	22	23	80 NBR B246	Seal Set O216	24269898	-		○
	280	22,8	25	95 AU V142	T 20	49009475	-		○
	280	25	26	90 NBR 109	N 1	18096	-		○
	280	26	27	94 AU 925	AUN 1	103840	-		○
	280	50,5	50,5	BHNBR B4B246	ES	24100419	-		○
	280	50,5	50,5	BHNBR B4B246	ES	24218910	IP		●
	280	52	50,5	BHNBR B4B246	ES	24218527	-		○
	280	52	50,5	BHNBR B4B246	ES	24218737	-		○
	280	60	60	BHNBR B4B246	ES	24061638	IP		●
250	280	60	60	BHNBR B4B246	ES	24218913	-		○
	280	61,5	60	BHNBR B4B246	ES	24104086	-		○
	280	61,5	60	BHNBR B4B246	ES	24218529	-		○
	280	93,5	93,5	BHNBR B5B210	V 1000	24067783	-		○
	280	95	95	BHNBR B5B210	V 1000	24095018	-		○
	280	95	95	BHNBR B5B210	V 1000	24265123	-		○
	280	98	98	BHNBR B5B210	V 1000	24064546	-		○
	280	100	100	BHNBR B5B210	V 1000	24079929	-		○
	280	100	100	BHNBR B5B210	V 1000	24178563	-		○
	280	100	100	BHNR B5A151	V 1000	24104948	-		○
	280	120	120	BHNBR B5B210	V 1000	24088939	-		○
	280	120	120	BHNR B5A151	V 1000	24187032	-		○
	280	123,5	123,5	BHNBR B5B210	V 1000	24331791	-		○
	280	125	125	BHNBR B5B210	V 1000	24131452	-		○
	280	125	125	BHNBR B5B210	V 1000	24314411	-		○
	280	125	125	BHNR B5A151	V 1000	24259447	-		○
	290	112	112	BHNBR B6B210	V 1000	24351541	-		○
	290	122	122	BHNBR B6B210	V 1000	24361128	-		○
	290	145	145	BHNR B6A151	V 1000	24092915	-		○
	290	186	186	BHNR B6A151	V 1000	24336364	-		○
	310	14	4	88 NBR 101	H MF	10492	-		○
252	292	128	128	BHNR B6A151	V 1000	527305	-		○
	274,5	7,6	8,1	PTFE B602/NBR	OMS-MR	24307570	-		○
254	274,5	7,6	8,1	PTFE GM201/NBR	OMS-MR	24307702	-		○
	274,6	14,6	16	95 AU V142	T 20	24359559	-		○
	292,1	155,6	155,6	BHNBR B6B210	V 1000	24293343	-		○
	270	10,5	11	31BF/70 A305	SPNC	GS2103-F0	-	○	
255	275	14,6	16	95 AU V142	T 20	49004326	-		○
	275,5	7,6	8,1	PTFE B602/NBR	OMS-MR	24358978	-		○
	275,5	7,6	8,1	PTFE B602/NBR	OMS-MR PR	49015011	-		○

d [mm]	D [mm]	H [mm]	L [mm]	Material	Design	Part No.	PU ¹⁾	US	EU
	275	10,5	11	31BF/70 A305	SPNC	GS2104-F0	-	○	
	280	9,8	10	19YF/A305	SPNO	GS2845-V0	-	○	
	280	14,6	16	94 AU 30000	T 20	49334425	-		○
	280	14,6	16	95 AU V142	T 20	24339213 40422472	IP SP		● ●
	280	16,6	18	95 AU V142	T 23	24377505	-		○
	280	16,6	18	93 AU V167	TM 23	24374345	-		○
	284	7,6	8,1	PTFE B602/NBR	OMS-MR	24223180	IP		●
	284	7,6	8,1	PTFE B602/FKM	OMS-MR	24258139	IP		●
	284	7,6	8,1	PTFE GM201/NBR	OMS-MR	24223691	-		○
	284	7,6	8,1	PTFE B602/NBR	OMS-MR PR	49016862	-		○
	284	7,6	8,1	PTFE C104/NBR	OMS-MR PR	49019084	-		○
	284	7,6	8,1	PTFE GM201/FKM	OMS-MR PR	49015687	-		○
	284	8,1	8,1	PTFE GM201/FKM	OMS-MR	49016730	-		○
	285	11,7	12,5	PTFE B602	OMS-S	24371158	-		○
	285	11,7	12,5	PTFE GM201	OMS-S	24177004	-		○
	285	11,7	12,5	PTFE GM201	OMS-S PR	49002343	-		○
	285	11,7	12,5	PTFE GM201	OMS-S PR	49016727	-		○
	285	12	13	90 NBR 109	N 1	11896	-		○
	285	16	17	U641	ISI	FU1704-K1	-	○	
260	285	16	17	U801	ISI	FU1704-K0	-	○	
	285	19	20	94 U801	IDI	FU1705-F0	-	○	
	290	18,2	20	95 AU V142	T 20	526753	-		○
	290	19	20	94 U801	IDI	FU1707-F0	-	○	
	290	20,9	23	95 AU V142	T 20	528155	-		○
	290	22	23	80 NBR B246	Seal Set 0216	24316621	-		○
	290	22	24	95 AU V142	NRS-0503	49064769	-		○
	290	50,5	50,5	BHNBR B4B246	ES	24067374	-		○
	290	50,5	50,5	BHNBR B4B246	ES	24218917	-		○
	290	52	50,5	BHNBR B4B246	ES	24218534	-		○
	290	52	50,5	BHNBR B4B246	ES	24218739	-		○
	290	60	60	BHNBR B4B246	ES	24218920	-		○
	290	60	60	BHNBR B4B246	ES	24219178	-		○
	290	61,5	60	BHNBR B4B246	ES	24101540	-		○
	290	61,5	60	BHNBR B4B246	ES	24218537	-		○
	290	148,5	148,5	BHNR B5A151	V 1000	24146185	-		○
	300	20	21	90 NBR 109	N 1	17203	-		○
	300	128	128	BHNBR B6B210	V 1000	24149020	-		○
	300	145	145	BHNBR B6B210	V 1000	24094118	-		○
	300	145	145	BHNR B6A151	V 1000	24342650	-		○
	300	160	160	BHNBR B6B210	V 1000	24127684	-		○
	280	10,5	11	31BF/70 A305	SPNC	GS2105-F0	-	○	
	285	14,6	16	95 AU V142	T 20	49039551	-		○
	285,5	7,6	8,1	PTFE B602/NBR	OMS-MR	49002205	-		○
	289	7,6	8,1	PTFE B602/NBR	OMS-MR	24275172	-		○
265	289	7,6	8,1	PTFE B602/FKM	OMS-MR	49007307	-		○
	289	7,6	8,1	PTFE C104/NBR	OMS-MR PR	49017636	IP		●
	290	11,7	12,5	PTFE B602	OMS-S	24234339	-		○
	290	18,2	20	95 AU V142	T 23	24377506	-		○
	297	24	25	94 U801	IDI	FU1714-F0	-	○	

d [mm]	D [mm]	H [mm]	L [mm]	Material	Design	Part No.	PU ¹⁾	US	EU
	297	25	26	94 U801	IDI	FU2183-F0	-	○	
265	305	145	145	BHNR B6A151	V 1000	24336149	-		○
	305	177	177	BHNR B6B210	V 1000	24192894	-		○
266,7	298,5	127	127	BHNR B5A151	V 1000	24174946	-		○
269,9	308	127	127	BHNR B6A151	V 1000	24094332	-		○
270	30	19	20	94 U801	IDI	FU1723-F0	-	○	
	30	24	25	94 U801	IDI	FU1725-F0	-	○	
	30	25	26	94 U801	IDI	FU1726-F0	-	○	
	285	10,5	11	31BF/70 A305	SPNC	GS2106-F0	-	○	
	290	9,8	10	19YF/A305	SPNO	GS2846-V0	-	○	
	290	14,6	16	95 AU V142	T 20	24331910	-		○
	294	7,6	8,1	PTFE B602/NBR	OMS-MR	24223183	-		○
	294	7,6	8,1	PTFE B602/FKM	OMS-MR	24344736	-		○
	294	7,6	8,1	PTFE GM201/NBR	OMS-MR	24123234	-		○
	294	7,6	8,1	PTFE B602/NBR	OMS-MR PR	49016776	IP		●
	295	11,7	12,5	PTFE GM201	OMS-S	24224737	-		○
	295	16	17	U641	ISI	FU1720-K1	-	○	
	295	16	17	U801	ISI	FU1720-K0	-	○	
	295	19	20	94 U801	IDI	FU1721-F0	-	○	
	300	17,3	19	95 AU V142	T 20	24361563	-		○
	300	17,3	19	95 AU V142	T 20	49001749	-		○
	300	20,9	23	93 AU V167	TMP 20	24368245	-		○
	300	22	23	90 NBR 109	N 100	18078	-		○
	300	22	23	80 NBR B246	Seal Set 0214	24266413	-		○
	300	22	23	80 NBR B246	Seal Set 0216	24266414	-		○
	300	22,5	24	95 AU V142	T 20	24360583	-		○
	300	123,5	123,5	BHNR B5B210	V 1000	24335561	-		○
	310	160	160	BHNR B6A151	V 1000	24120872	-		○
310	177	177	BHNR B6B210	V 1000	24069270	-		○	
275	290	10,5	11	31BF/70 A305	SPNC	GS2107-F0	-	○	
	300	18,2	20	95 AU V142	T 23	24377507	-		○
	305	17,3	19	95 AU V142	T 20	24327509	-		○
	315	128	128	BHNR B6A151	V 1000	530313	-		○
	315	160	160	BHNR B6A151	V 1000	24112170	-		○
279,4	311,2	114,2	114,2	BHNR B5B210	V 1000	24174288	-		○
	317,5	146,2	146,2	BHNR B6A151	V 1000	24083634	-		○
280	30	9,8	10	19YF/A305	SPNO	GS2847-V0	-	○	
	295	10,5	11	31BF/70 A305	SPNC	GS2108-F0	-	○	
	300	15	16,5	95 AU V142	T 20	24359724	-		○
	304	7,6	8,1	PTFE B602/NBR	OMS-MR	24214089	IP		●
	304	7,6	8,1	PTFE B602/FKM	OMS-MR	24344737	IP		●
	304	7,6	8,1	PTFE C104/NBR	OMS-MR	49035776	-		○
	304	7,6	8,1	PTFE GM201/NBR	OMS-MR	24177957	-		○
	304	7,6	8,1	PTFE GM201/FKM	OMS-MR	24380211	-		○
	304	7,6	8,1	PTFE B602/NBR	OMS-MR PR	49020179	-		○
	304	7,6	8,1	PTFE C104/NBR	OMS-MR PR	49017748	-		○
	305	11,7	12,5	PTFE B602	OMS-S	24378032	-		○
	305	11,7	12,5	PTFE GM201	OMS-S	24192379	IP		●
	305	11,7	12,5	PTFE GM201	OMS-S PR	49017440	-		○
	305	16	17	U641	ISI	FU1733-K1	-	○	

d [mm]	D [mm]	H [mm]	L [mm]	Material	Design	Part No.	PU ¹⁾	US	EU
	305	16	17	U801	ISI	FU1733-K0	-	○	
	305	19	20	94 U801	IDI	FU1734-F0	-	○	
	310	15	16	90 NBR 109	N 1	17209 40421520	IP SP		● ●
	310	17,3	19	95 AU V142	T 20	24223334 40422285	IP SP		● ●
	310	19	20	94 U801	IDI	FU1736-F0	-	○	
	310	20,9	23	93 AU V167	TMP 20	24368246	-		○
	310	22	23	80 NBR B246	Seal Set O214	24265062	-		○
	310	22	23	80 NBR B246	Seal Set O216	24269899	-		○
	310	50,5	50,5	BHNBR B4B246	ES	24219179	-		○
	310	60	60	BHNBR B4B246	ES	24066929	-		○
	310	60	60	BHNBR B4B246	ES	24218933	-		○
	310	61,5	60	BHNBR B4B246	ES	24064013	-		○
	310	61,5	60	BHNBR B4B246	ES	24071155	-		○
	312	24	25	94 U801	IDI	FU2136-F0	-	○	
	312	25	26	94 U801	IDI	FU2184-F0	-	○	
280	320	20	21	90 NBR 109	N 1	17208	-		○
	320	80	80	BHNBR B4B246	ES	24072791	-		○
	320	80	80	BHNBR B4B246	ES	24114214	-		○
	320	81,5	80	BHNBR B4B246	ES	24113699	-		○
	320	81,5	80	BHNBR B4B246	ES	24121893	-		○
	320	128	128	BHNBR B6B210	V 1000	24069570	-		○
	320	128	128	BHNBR B6B210	V 1000	24088941	-		○
	320	142,2	142,2	BHNBR B6B210	V 1000	24073728	-		○
	320	145	145	BHNBR B6B210	V 1000	24147219	-		○
	320	145	145	BHNR B6A151	V 1000	24082121	-		○
	320	160	160	BHNR B6A151	V 1000	24076833	-		○
	320	177	177	BHNBR B6B210	V 1000	24373451	-		○
	320	186	186	BHNBR B6B210	V 1000	24105201	-		○
	320	192	192	BHNBR B6B210	V 1000	24312668	-		○
	324	177	177	BHNBR B5B210	V 1000	24361148	-		○
	330	12	3	88 NBR 101	H MF	10500	-		○
	30	10,5	11	31BF/70 A305	SPNC	GS2109-F0	-	○	
	309	7,6	8,1	PTFE B602/NBR	OMS-MR	24357557	-		○
	309	7,6	8,1	PTFE B602/NBR	OMS-MR PR	49027565	-		○
285	315	17,3	19	95 AU V142	T 20	531811	-		○
	325	128,1	128,1	BHNBR B6B210	V 1000	24296272	-		○
	325	177	177	BHNBR B6B210	V 1000	24173263	-		○
	330	34	35	94 AU 925	AUN 1	103847	-		○
	305	10,5	11	31BF/70 A305	SPNC	GS2110-F0	-	○	
	310	9,8	10	19YF/A305	SPNO	GS2848-V0	-	○	
	314	7,6	8,1	PTFE B602/NBR	OMS-MR	24223186	IP		●
	314	7,6	8,1	PTFE B602/FKM	OMS-MR	24336138	-		○
	314	7,6	8,1	PTFE GM201/NBR	OMS-MR	24223692	-		○
290	314	7,6	8,1	PTFE B602/NBR	OMS-MR PR	49012804	-		○
	315	11,7	12,5	PTFE GM201	OMS-S	24195056	-		○
	315	11,7	12,5	PTFE GM201	OMS-S PR	49031374	-		○
	315	16	17	U641	ISI	FU1748-K1	-	○	
	315	16	17	U801	ISI	FU1748-K0	-	○	
	315	18,2	20	95 AU V142	T 23	24377508	-		○

d [mm]	D [mm]	H [mm]	L [mm]	Material	Design	Part No.	PU ¹⁾	US	EU
290	315	18,2	20	93 AU V167	TM 23	24316205	-		○
	315	19	20	94 U801	IDI	FU1749-F0	-	○	
	320	17,3	19	95 AU V142	T 20	24356384	-		○
	320	19	20	94 U801	IDI	FU1751-F0	-	○	
	330	20	21	90 NBR 109	N 1	17211	-		○
	330	145	145	BHNBR B6B210	V 1000	24100201	-		○
292,1	342,4	152	152	BHNBR B6A151	V 1000	24110184	-		○
	330,2	127	127	BHNBR B6A151	V 1000	24334915	-		○
295	310	10,5	11	31BF/70 A305	SPNC	GS2111-F0	-	○	
	319	7,6	8,1	PTFE B602/NBR	OMS-MR	49027157	-		○
	319	7,6	8,1	PTFE B602/NBR	OMS-MR PR	49037793	-		○
	319	7,6	8,1	PTFE C104/NBR	OMS-MR PR	49017637	-		○
	335	131	131	BHNBR B6B210	V 1000	527357	-		○
300	315	10,5	11	31BF/70 A305	SPNC	GS2112-F0	-	○	
	320	9,8	10	19YF/A305	SPNO	GS2849-V0	-	○	
	320	14,6	16	95 AU V142	NRS-0503	49021013	-		○
	324	7,6	8,1	PTFE B602/NBR	OMS-MR	24214091	IP		●
	324	7,6	8,1	PTFE B602/FKM	OMS-MR	24344739	IP		●
	324	7,6	8,1	PTFE GM201/NBR	OMS-MR	24213516	-		○
	324	7,6	8,1	PTFE GM201/FKM	OMS-MR	24374011	-		○
	324	7,6	8,1	PTFE B602/NBR	OMS-MR PR	49020994	IP		●
	324	7,6	8,1	PTFE C104/NBR	OMS-MR PR	49043086	IP		●
	325	11,7	12,5	PTFE GM201	OMS-S	24208689	IP		●
	325	11,7	12,5	PTFE GM201	OMS-S	24357990	-		○
	325	11,7	12,5	PTFE B602	OMS-S PR	49018104	-		○
	325	11,7	12,5	PTFE GM201	OMS-S PR	49030569	-		○
	325	16	17	U641	ISI	FU1762-K1	-	○	
	325	16	17	U801	ISI	FU1762-K0	-	○	
	325	19	20	94 U801	IDI	FU1763-F0	-	○	
	330	11,7	12,5	PTFE B602	OMS-S	527845	-		○
	330	16	17	90 NBR 109	N 1	17214	-		○
	330	17,3	19	95 AU V142	T 20	24351902	IP		●
	330	19	20	94 U801	IDI	FU1765-F0	-	○	
	330	21,5	23,6	95 AU V142	T 20	24377304	-		○
	330	21,8	24	95 AU V142	T 20	24361028	-		○
	330	22	23	90 NBR 109	N 100	17434	-	○	○
	330	22	23	80 NBR B246	Seal Set 0214	24237123	-		○
	330	22	23	80 NBR B246	Seal Set 0216	24245117	-		○
	330	22	24	95 AU V142	NRS-0503	49033965	-		○
	330	50,5	50,5	BHNBR B4B246	ES	24218941	IP		●
	330	52	50,5	BHNBR B4B246	ES	24121478	-		○
	330	58	58	BHNBR B4B246	ES	24074670	-		○
	330	60	60	BHNBR B4B246	ES	24218944	IP		●
	330	61,5	60	BHNBR B4B246	ES	24071159	-		○
	332	24	25	94 U801	IDI	FU2137-F0	-	○	
	332	25	26	94 U801	IDI	FU2185-F0	-	○	
340	20	21	90 NBR 109	N 100	17216	-	○	○	
340	24	25	80 NBR B246	Seal Set 0214	24245487	-		○	
340	80	80	BHNBR B4B246	ES	24073340	-		○	
340	80	80	BHNBR B4B246	ES	24078123	-		○	

d [mm]	D [mm]	H [mm]	L [mm]	Material	Design	Part No.	PU ¹⁾	US	EU
	340	81,5	80	BHNBR B4B246	ES	24066737	-		○
	340	81,5	80	BHNBR B4B246	ES	24114599	-		○
	340	113	113	BHNBR B6B210	V 1000	24074692	-		○
	340	113	113	BHNBR B6B210	V 1000	24091937	-		○
	340	126	126	BHNBR B6B210	V 1000	24332577	-		○
	340	131	131	BHNBR B6B210	V 1000	24341825	-		○
300	340	131	131	BHNR B6A151	V 1000	24105199	-		○
	340	145	145	BHNBR B6B210	V 1000	24073932	-		○
	340	145	145	BHNR B6A151	V 1000	24114005	-		○
	340	158	158	BHNBR B6B210	V 1000	24073420	-		○
	340	177	177	BHNBR B6B210	V 1000	24129980	-		○
	340	177	177	BHNR B6A151	V 1000	24288296	-		○
	356	20	5	88 NBR 101	H MF	10504	-		○
300,3	324,3	7,6	8,1	PTFE GM201 /FKM	OMS-MR	49041243	-		○
	330,2	18,1	19,8	95 AU V142	T 20	24366949	-		○
304,8	342,9	127,1	127,1	BHNR B6A151	V 1000	24339833	-		○
	342,9	133,4	133,4	BHNBR B6B210	V 1000	24377840	-		○
	342,9	155,7	155,7	BHNR B6A151	V 1000	24103677	-		○
	330	18,2	20	95 AU V142	T 23	24377509	-		○
305	330	18,2	20	93 AU V167	TM 23	24263445	-		○
	336,8	76	76	BHNBR B5B210	V 1000	24145000	-		○
	345	145	145	BHNBR B6B210	V 1000	24223611	-		○
306	331	20	22	95 AU V142	T 20	24361684	-		○
307	331	7,6	8,1	PTFE B602 /NBR	OMS-MR	24359616	-		○
	330	9,8	10	19YF /A305	SPNO	GS2850-V0	-	○	
	334	7,6	8,1	PTFE B602 /NBR	OMS-MR	24223189	-		○
	334	7,6	8,1	PTFE B602 /FKM	OMS-MR	24344740	-		○
	334	7,6	8,1	PTFE B602 /NBR	OMS-MR PR	49054856	-		○
	334	7,6	8,1	PTFE C104 /NBR	OMS-MR PR	49023881	-		○
	340	14	15	PTFE GM201	OMS-S	24194530	-		○
310	340	17,3	19	95 AU V142	T 20	24358215	-		○
	350	20	21	90 NBR 109	N 1	17219 5617219	IP	○	●
	350	113	113	BHNBR B6B210	V 1000	24251438	-		○
	350	145	145	BHNBR B6B210	V 1000	24096028	-		○
	350	145	145	BHNR B6A151	V 1000	24191553	-		○
	350	177	177	BHNR B6A151	V 1000	24108181	-		○
	350	195	195	BHNBR B6B210	V 1000	24292048	-		○
312	356	145	145	BHNR B6A151	V 1000	24339726	-		○
	330	10,5	11	31BF /70 A305	SPNC	GS2113-F0	-	○	
	339	7,6	8,1	PTFE B602 /NBR	OMS-MR	24360278	-		○
	339	7,6	8,1	PTFE GM201 /NBR	OMS-MR	49027877	-		○
315	339	7,6	8,1	PTFE GM201 /NBR	OMS-MR PR	49041460	-		○
	345	14	15	PTFE GM201	OMS-S	24250718	-		○
	355	128	128	BHNBR B6B210	V 1000	24347013	-		○
	355	145	145	BHNBR B6B210	V 1000	24072391	-		○
	355	177	177	BHNBR B6B210	V 1000	24119151	-		○
316,2	346,2	14	15	PTFE B602	OMS-S PR	24118459	-		○
317	341	7,6	8,1	PTFE GM201 /FKM	OMS-MR	49041242	-		○
318	362	145	145	BHNBR B6B210	V 1000	24355004	-		○

d [mm]	D [mm]	H [mm]	L [mm]	Material	Design	Part No.	PU ¹⁾	US	EU
318,7	362,7	177	177	BHNBR B6B210	V 1000	24223370	-		○
	335	10,5	11	31BF/70 A305	SPNC	GS2114F0	-	○	
	340	9,8	10	19YF/A305	SPNO	GS2851-V0	-	○	
	340	14,6	16	95 AU V142	TM 20	24357237	IP		●
	344	7,6	8,1	PTFE B602/NBR	OMS-MR	24214093	IP		●
	344	7,6	8,1	PTFE B602/FKM	OMS-MR	24311132	-		○
	344	7,6	8,1	PTFE GM201/NBR	OMS-MR	24223694	-		○
	344	7,6	8,1	PTFE B602/NBR	OMS-MR PR	49013550	IP		●
	344	7,6	8,1	PTFE C104/NBR	OMS-MR PR	49024658	-		○
	344	7,6	8,1	PTFE GM201/NBR	OMS-MR PR	49055891	-		○
	347,3	8,7	9,5	PTFE B602/NBR	OMS-MR	24360032	-		○
	350	14	15	PTFE B602	OMS-S	24338624	-		○
	350	14	15	PTFE GM201	OMS-S	24209894	IP		●
	350	14	15	PTFE GM201	OMS-S PR	49003542	IP		●
	350	16	17	94 AU 925	AUN 100	103853	-		○
	350	17,3	19	95 AU V142	T 20	24335042	IP		●
	350	22	23	90 NBR 109	N 100	17734	-		○
	350	22	23	80 NBR B246	Seal Set 0216	24269900	-		○
	350	22,8	25	95 AU V142	TM 20	24359549	IP		●
	350	50,5	50,5	BHNBR B4B246	ES	24218956	-		○
	350	52	50,5	BHNBR B4B246	ES	24218559	-		○
	350	60	60	BHNBR B4B246	ES	24218959	-		○
	350	61,5	60	BHNBR B4B246	ES	24071163	-		○
	350	148,5	148,5	BHNR B5A151	V 1000	527010	-		○
320	360	20	3	88 NBR 101	H MF	10509	-		○
	360	20	21	80 NBR B246	Seal Set 0214	24245104	-		○
	360	29,1	32	95 AU V142	TM 20	24359550	-		○
	360	30	32	80 NBR B246	Seal Set 0214	24262827	-		○
	360	30	32	80 NBR B246	Seal Set 0216	24248351	-		○
	360	64,5	63	BHNBR B4B246	ES	24145831	-		○
	360	80	80	BHNBR B4B246	ES	24066450	-		○
	360	80	80	BHNBR B4B246	ES	24218961	-		○
	360	81,5	80	BHNBR B4B246	ES	24084628	-		○
	360	81,5	80	BHNBR B4B246	ES	24111755	-		○
	360	113	113	BHNBR B6B210	V 1000	24081756	-		○
	360	113	113	BHNBR B6B210	V 1000	24198245	-		○
	360	128	128	BHNBR B6B210	V 1000	24329555	-		○
	360	145	145	BHNBR B6B210	V 1000	24083098	-		○
	360	145	145	BHNBR B6B210	V 1000	24090386	-		○
	360	145	145	BHNBR B6B210	V 1000	24134796	-		○
	360	145	145	BHNBR B6B210	V 1000	24308161	-		○
	360	145	145	BHNR B6A151	V 1000	24220676	-		○
	360	160	160	BHNBR B6B210	V 1000	24349309	-		○
	360	163	163	BHNBR B6B210	V 1000	24377739	-		○
	360	163	163	BHNR B6A151	V 1000	24233272	-		○
	364	145	145	BHNR B6A151	V 1000	24337559	-		○
	370	150	150	BHNBR B6B210	V 1000	24068349	-		○
	370	190	190	BHNR B6A151	V 1000	24140308	-		○
	349	7,6	8,1	PTFE B602/NBR	OMS-MR	49003815	-		○
325	355	14	15	PTFE GM201	OMS-S	24294165	-		○

d [mm]	D [mm]	H [mm]	L [mm]	Material	Design	Part No.	PU ¹⁾	US	EU
325	355	20	22	93 AU V167	TM 23	24359407	-		○
327,5	351,5	7,6	8,1	PTFE B602 /FKM	OMS-MR	49041973	-		○
	350	9,8	10	19YF /A305	SPNO	GS2852-V0	-	○	
	354	7,6	8,1	PTFE B602 /NBR	OMS-MR	24223192	-		○
	354	7,6	8,1	PTFE B602 /FKM	OMS-MR	24344741	-		○
	354	7,6	8,1	PTFE GM201 /NBR	OMS-MR	24223695	-		○
	354	7,6	8,1	PTFE B602 /NBR	OMS-MR PR	49012805	IP		●
	354	7,6	8,1	PTFE GM201 /NBR	OMS-MR PR	49004616	-		○
330	360	14	15	PTFE GM201	OMS-S	24141409	IP		●
	360	20,9	23	93 AU V167	TMP 20	49001221	-		○
	360	22,8	25	95 AU V142	TM 20	24359743	-		○
	370	113	113	BHNBR B6B210	V 1000	24376045	-		○
	370	145	145	BHNBR B6B210	V 1000	24352154	-		○
	370	145	145	BHNR B6A151	V 1000	24068708	-		○
	370	177	177	BHNBR B6B210	V 1000	24181589	-		○
	390	20	3	88 NBR 101	H MF	10511	-		○
330,2	354,2	7,6	8,1	PTFE B602 /NBR	OMS-MR	24358310	-		○
	368,3	145	145	BHNBR B6B210	V 1000	24263431	-		○
	350	10,5	11	31BF /70 A305	SPNC	GS2115-F0	-	○	
	359	7,6	8,1	PTFE B602 /NBR	OMS-MR	24351685	-		○
	359	7,6	8,1	PTFE C104 /NBR	OMS-MR PR	49017638	IP		●
335	365	14	15	PTFE GM201	OMS-S	531547	-		○
	375	145	145	BHNBR B6B210	V 1000	24292075	-		○
	375	145	145	BHNR B6A151	V 1000	24227944	-		○
	375	160	160	BHNR B6A151	V 1000	24235542	-		○
	355	10,5	11	31BF /70 A305	SPNC	GS2116-F0	-	○	
	360	9,8	10	19YF /A305	SPNO	GS2853-V0	-	○	
	360	14,6	16	95 AU V142	TM 20	24369208	-		○
	364	7,6	8,1	PTFE B602 /NBR	OMS-MR	24223195	IP		●
	364	7,6	8,1	PTFE B602 /FKM	OMS-MR	24344742	-		○
	364	7,6	8,1	PTFE GM201 /NBR	OMS-MR	24223696	-		○
	364	7,6	8,1	PTFE B602 /NBR	OMS-MR PR	49013224	-		○
	364	7,6	8,1	PTFE C104 /NBR	OMS-MR PR	49021631	-		○
	370	14	15	PTFE GM201	OMS-S	24224735	-		○
	370	14	15	PTFE GM201	OMS-S PR	530525	-		○
	370	20	22	93 AU V167	TM 23	24331187	-		○
	370	22,8	26	95 AU V142	TM 20	24360008	-		○
340	370	50,5	50,5	BHNBR B4B246	ES	24099882	-		○
	370	52	50,5	BHNBR B4B246	ES	24218566	-		○
	370	58	58	BHNBR B4B246	ES	24081906	-		○
	370	60	60	BHNBR B4B246	ES	24218968	-		○
	380	30	32	94 AU 925	NRS-0503	49022624	-		○
	380	80	80	BHNBR B4B246	ES	24063605	-		○
	380	80	80	BHNBR B4B246	ES	24218969	-		○
	380	81,5	80	BHNBR B4B246	ES	24069050	-		○
	380	81,5	80	BHNBR B4B246	ES	24148207	-		○
	380	128	128	BHNBR B6B210	V 1000	24341062	-		○
	380	128	128	BHNR B6A151	V 1000	24111899	-		○
	380	145	145	BHNBR B6B210	V 1000	24104204	-		○
	380	177	177	BHNBR B6B210	V 1000	528836	-		○

d [mm]	D [mm]	H [mm]	L [mm]	Material	Design	Part No.	PU ¹⁾	US	EU
342	382	128	128	BHNR B6A151	V 1000	24354084	-		○
343	381,1	145	145	BHNBR B6B210	V 1000	24264137	-		○
345	365	14,6	16	95 AU V142	TM 20	49002919	-		○
	369	7,6	8,1	PTFE B602/NBR	OMS-MR	24354127	-		○
	385	145	145	BHNBR B6B210	V 1000	24330507	-		○
350	370	9,8	10	19YF/A305	SPNO	GS2854-V0	-	○	
	370	14,6	16	95 AU V142	TM 20	24357238	-		○
	374	7,6	8,1	PTFE B602/NBR	OMS-MR	24223198	-		○
	374	7,6	8,1	PTFE B602/FKM	OMS-MR	24344743	-		○
	374	7,6	8,1	PTFE GM201/NBR	OMS-MR	24223697	-		○
	374	7,6	8,1	PTFE B602/FKM	OMS-MR PR	49018008	-		○
	374	7,6	8,1	PTFE B602/NBR	OMS-MR PR	49036916	-		○
	374	7,6	8,1	PTFE C104/FKM	OMS-MR PR	49013920	-		○
	377,3	8,7	9,5	PTFE B602/FKM	OMS-MR	24380585	-		○
	380	14	15	PTFE B602	OMS-S	24338027	-		○
	380	14	15	PTFE GM201	OMS-S	24214029	-		○
	380	14	15	PTFE B602	OMS-S PR	49038827	-		○
	380	14	15	PTFE C104	OMS-S PR	49040590	-		○
	380	22	24	93 AU V167	NRS-0503	49026704	-		○
	380	22,8	25	95 AU V142	TM 20	24359746	-		○
	380	23,7	26	93 AU V167	TMP 20	24368249	-		○
	380	25	26	80 NBR B246	Seal Set 0214	24248695	-		○
	380	25	26	80 NBR B246	Seal Set 0216	24250321	-		○
	390	30	32	80 NBR B246	Seal Set 0214	49000836	-		○
	390	35	36	90 NBR 109	N 1	17226	-		○
390	128	128	BHNR B6A151	V 1000	49002536	-		○	
390	145	145	BHNR B6A151	V 1000	24080224	-		○	
400	18	5	88 NBR 101	H MF	10516	-		○	
410	150	150	BHNBR B6B210	V 1000	24087674	-		○	
351,6	375,6	7,6	8,1	PTFE GM201/FKM	OMS-MR	49041245	-		○
354	384	14	15	PTFE GM201	OMS-S	24370682	-		○
	394	145	145	BHNR B6A151	V 1000	24170918	-		○
355	370	10,5	11	31BF/70 A305	SPNC	GS2117-F0	-	○	
	379	7,6	8,1	PTFE B602/NBR	OMS-MR	24377705	-		○
	379	7,6	8,1	PTFE B602/NBR	OMS-MR PR	49017650	-		○
	379	7,6	8,1	PTFE C104/NBR	OMS-MR PR	49017750	-		○
360	375	10,5	11	31BF/70 A305	SPNC	GS2118-F0	-	○	
	380	9,8	10	19YF/A305	SPNO	GS2855-V0	-	○	
	380	14,6	16	95 AU V142	TM 20	24359719	IP		●
	384	7,6	8,1	PTFE B602/NBR	OMS-MR	24214095	IP		●
	384	7,6	8,1	PTFE B602/FKM	OMS-MR	24243374	-		○
	384	7,6	8,1	PTFE GM201/NBR	OMS-MR	24196617	-		○
	384	7,6	8,1	PTFE B602/NBR	OMS-MR PR	49014368	IP		●
	384	7,6	8,1	PTFE C104/NBR	OMS-MR PR	49024660	-		○
	384	7,6	8,1	PTFE GM201/NBR	OMS-MR PR	49058183	-		○
	390	14	15	PTFE B602	OMS-S	24338662	-		○
	390	14	15	PTFE GM201	OMS-S	24224746	-		○
	390	14	15	PTFE GM201	OMS-S PR	49035736	-		○
	390	22	23	94 AU 925	AUN 100	103854	-		○
	390	50,5	50,5	BHNBR B4B210	ES	24218979	-		○

d [mm]	D [mm]	H [mm]	L [mm]	Material	Design	Part No.	PU ¹⁾	US	EU
	390	50,5	50,5	BHNBR B4B246	ES	24087305	-		○
	390	52	50,5	BHNBR B4B210	ES	24218577	-		○
	390	58	58	BHNBR B4B246	ES	24097554	-		○
	390	60	60	BHNBR B4B210	ES	24218982	-		○
	390	60	60	BHNBR B4B246	ES	24219196	-		○
	390	61,5	60	BHNBR B4B210	ES	24073530	-		○
	390	61,5	60	BHNBR B4B246	ES	24218775	-		○
	400	20	21	90 NBR 109	N 1	17228	-		○
	400	23	24	80 NBR 878	NI 400	4560	-		○
	400	29,1	32	93 AU V168	TM 20	24359748	-		○
360	400	29,1	32	95 AU V142	TM 20	49022458	-		○
	400	30	32	80 NBR B246	Seal Set O216	24290064	-		○
	400	64,5	63	BHNBR B4B246	ES	24145834	-		○
	400	80	80	BHNBR B4B246	ES	24061644	-		○
	400	80	80	BHNBR B4B246	ES	24084039	-		○
	400	81,5	80	BHNBR B4B246	ES	24068143	-		○
	400	81,5	80	BHNBR B4B246	ES	24123407	-		○
	400	128	128	BHNBR B6B210	V 1000	24086871	-		○
	400	145	145	BHNBR B6B210	V 1000	24078133	-		○
	400	145	145	BHNR B6A151	V 1000	24313949	-		○
	400	160	160	BHNR B6A151	V 1000	24124593	-		○
	410	150	150	BHNBR B6B210	V 1000	24129904	-		○
365	389	7,6	8,1	PTFE B602/NBR	OMS-MR PR	49037296	-		○
	390	9,8	10	19YF/A305	SPNO	GS2856-V0	-	○	
	390	14,6	16	95 AU V142	NRS-0503	49021014	-		○
	394	7,6	8,1	PTFE B602/NBR	OMS-MR	24275719	-		○
	394	7,6	8,1	PTFE B602/FKM	OMS-MR	24344744	-		○
	394	7,6	8,1	PTFE GM201/NBR	OMS-MR	24275883	-		○
	394	7,6	8,1	PTFE B602/NBR	OMS-MR PR	49020995	-		○
	400	14	15	PTFE GM201	OMS-S	24224751	-		○
	400	22,8	25	95 AU V142	TM 20	24359749	-		○
	400	23,7	26	93 AU V167	TMP 20	24368250	-		○
	400	23,8	26	95 AU V142	TM 20	49036122	-		○
370	400	25	26	80 NBR B246	Seal Set O214	24310654	-		○
	400	25	26	80 NBR B246	Seal Set O216	24310655	-		○
	400	50,5	50,5	BHNBR B4B210	ES	24218984	-		○
	400	52	50,5	BHNBR B4B210	ES	24218580	-		○
	400	60	60	BHNBR B4B210	ES	24218987	-		○
	400	61,5	60	BHNBR B4B210	ES	24107401	-		○
	410	80	80	BHNBR B4B246	ES	24099626	-		○
	410	80	80	BHNBR B4B246	ES	24218989	-		○
	410	81,5	80	BHNBR B4B246	ES	24097789	-		○
	410	81,5	80	BHNBR B4B246	ES	24194332	-		○
	410	145	145	BHNBR B6B210	V 1000	24094958	-		○
371,3	395,3	7,6	8,1	PTFE GM201/FKM	OMS-MR	49041244	-		○
373	397	7,6	8,1	PTFE B602/NBR	OMS-MR	24379294	-		○
	390	10,5	11	31BF/70 A305	SPNC	GS2119-F0	-	○	
375	399	7,6	8,1	PTFE B602/NBR	OMS-MR	24297527	-		○
	399	7,6	8,1	PTFE GM201/NBR	OMS-MR	24297525	-		○
	399	7,6	8,1	PTFE C104/NBR	OMS-MR PR	49026725	-		○

d [mm]	D [mm]	H [mm]	L [mm]	Material	Design	Part No.	PU ¹⁾	US	EU
376	420	145	145	BHNBR B6B210	V 1000	24107256	-		○
377	407	14	15	PTFE GM201	OMS-S	24258066	-		○
	40	9,8	10	19YF/A305	SPNO	GS2857-V0	-	○	
	400	14,6	16	95 AU V142	TM 20	24359750	-		○
	404	7,6	8,1	PTFE B602/NBR	OMS-MR	24275731	IP		●
	404	7,6	8,1	PTFE B602/FKM	OMS-MR	24344745	-		○
	404	7,6	8,1	PTFE GM201/NBR	OMS-MR	24275871	-		○
	404	7,6	8,1	PTFE B602/NBR	OMS-MR PR	49012806	-		○
	404	7,6	8,1	PTFE C104/NBR	OMS-MR PR	49017639	-		○
	410	14	15	PTFE B602	OMS-S PR	49027736	-		○
	410	14	15	PTFE GM201	OMS-S PR	49027663	-		○
	410	15	15	PTFE GM201	OMS-S	24182881	IP		●
	410	22,8	25	95 AU V142	TM 20	49001346	-		○
	410	50,5	50,5	BHNBR B4B210	ES	24218990	-		○
	410	60	60	BHNBR B4B210	ES	24218993	-		○
380	410	61,5	60	BHNBR B4B210	ES	24213225	-		○
	420	20	21	90 NBR 109	N 1	17231	-		○
	420	29,1	32	95 AU V142	TM 20	24359751	-		○
	420	30	32	80 NBR B246	Seal Set 0214	24265065	-		○
	420	30	32	80 NBR B246	Seal Set 0216	24275210	-		○
	420	80	80	BHNBR B4B246	ES	24069067	-		○
	420	81,5	80	BHNBR B4B246	ES	24069165	-		○
	420	113	113	BHNBR B6B210	V 1000	24079891	-		○
	420	113	113	BHNR B6A151	V 1000	24208753	-		○
	420	145	145	BHNBR B6B210	V 1000	24079873	-		○
	420	158	158	BHNBR B6B210	V 1000	24073422	-		○
	420	160	160	BHNR B6A151	V 1000	24334129	-		○
	420	177	177	BHNBR B6B210	V 1000	24127561	-		○
	430	30	32	95 AU V142	NRS-0503	524856	-		○
	40	10,5	11	31BF/70 A305	SPNC	GS2120-F0	-	○	
385	415	23,8	26	95 AU V142	TM 20	527751	-		○
	425	160	160	BHNBR B6B210	V 1000	24312117	-		○
	430	144	144	BHNR B6A151	V 1000	24342155	-		○
	414	7,6	8,1	PTFE B602/NBR	OMS-MR	24275745	-		○
	414	7,6	8,1	PTFE GM201/NBR	OMS-MR	24275912	-		○
	414	7,6	8,1	PTFE B602/NBR	OMS-MR PR	49027566	-		○
	415	15	16	90 NBR 109	N 1	17233	-		○
	420	14	15	PTFE GM201	OMS-S	24224739	-		○
	420	22,8	25	95 AU V142	TM 20	24359752	-		○
	420	23	25	95 AU V142	NRS-0503	24371212	-		○
	420	23,7	26	93 AU V167	TMP 20	24368251	-		○
390	420	25	26,5	80 NBR B246	Seal Set 0214	24289371	-		○
	420	25	26,5	80 NBR B246	Seal Set 0216	24289372	-		○
	420	33	35	95 AU V142	NRS-0503	49044818	-		○
	420	50,5	50,5	BHNBR B4B210	ES	24218996	-		○
	420	52	50,5	BHNBR B4B210	ES	24218588	-		○
	420	60	60	BHNBR B4B210	ES	24187142	-		○
	420	61,5	60	BHNBR B4B210	ES	24126556	-		○
	420	123,5	123,5	BHNBR B5B210	V 1000	24373364	-		○
	420	123,5	123,5	BHNR B5A151	V 1000	24291700	-		○

d [mm]	D [mm]	H [mm]	L [mm]	Material	Design	Part No.	PU ¹⁾	US	EU
390	430	80	80	BHNBR B4B210	ES	24145527	-		○
	430	81,5	80	BHNBR B4B210	ES	24100035	-		○
	430	126	126	BHNR B6A151	V 1000	24108188	-		○
392	416	7,6	8,1	PTFE B602/NBR	OMS-MR	49040092	-		○
395	419	7,6	8,1	PTFE B602/NBR	OMS-MR	24328302	-		○
	435	190	190	BHNBR B6B210	V 1000	24244761	-		○
398	428	14	15	PTFE GM201	OMS-S	24349031	-		○
400	420	14,6	16	95 AU V142	TM 20	24359753	-		○
	424	7,6	8,1	PTFE B602/NBR	OMS-MR	24259183	IP		●
	424	7,6	8,1	PTFE B602/FKM	OMS-MR	24357273	-		○
	424	7,6	8,1	PTFE GM201/NBR	OMS-MR	24275913	-		○
	424	7,6	8,1	PTFE B602/FKM	OMS-MR PR	49020262	-		○
	424	7,6	8,1	PTFE B602/NBR	OMS-MR PR	49027567	-		○
	424	7,6	8,1	PTFE C104/NBR	OMS-MR PR	49017751	-		○
	427,3	8,7	9,5	PTFE B602/NBR	OMS-MR	24373987	-		○
	427,3	8,7	9,5	PTFE B602/FKM	OMS-MR	24377936	-		○
	427,3	8,7	9,5	PTFE C104/FKM	OMS-MR PR	49019802	-		○
	430	14	15	PTFE B602	OMS-S	24379065	-		○
	430	14	15	PTFE GM201	OMS-S	24183343	IP		●
	430	14	15	PTFE GM201	OMS-S PR	49017441	-		○
	430	22	23	80 NBR B246	Seal Set O216	24308105	-		○
	430	22	24	94 AU 925	NRS-0503	49019806	-		○
	430	22,8	25	95 AU V142	TM 20	24359755	-		○
	430	23,7	26	93 AU V167	TMP 20	24368252	-		○
	430	25	26	90 NBR 109	N 100	1484	-		○
	430	50,5	50,5	BHNBR B4B210	ES	24219000	-		○
	430	50,5	50,5	BHNBR B4B210	ES	24219197	-		○
	430	52,5	52,5	BHNBR B4B210	ES	24198468	-		○
	430	52,5	52,5	BHNBR B4B210	ES	24219198	-		○
	430	60	60	BHNBR B4B210	ES	24087212	-		○
	430	60	60	BHNBR B4B210	ES	24219200	-		○
	430	61,5	60	BHNBR B4B210	ES	24071209	-		○
	430	61,5	60	BHNBR B4B210	ES	24087903	-		○
	440	20	21	90 NBR 109	N 1	17234 1723400	-		○
	440	29,1	32	95 AU V142	TM 20	24359754	-		○
	440	70	70	BHNBR B4B210	ES	24219002	-		○
	440	70	70	BHNBR B4B210	ES	24219201	-		○
	440	79	79	BHNBR B4B210	ES	24219202	-		○
	440	80	80	BHNBR B4B210	ES	24071557	-		○
	440	80	80	BHNBR B4B210	ES	24219004	-		○
440	81,5	80	BHNBR B4B210	ES	24086147	-		○	
440	81,5	80	BHNBR B4B210	ES	24113319	-		○	
440	89	89	BHNBR B4B210	ES	24219203	-		○	
440	90,5	89	BHNBR B4B210	ES	24218593	-		○	
440	113	113	BHNBR B6B210	V 1000	24100722	-		○	
440	140,5	140,5	BHNR B6A151	V 1000	24260689	-		○	
440	143	143	BHNR B6A151	V 1000	24120783	-		○	
440	143	143	BHNR B6A151	V 1000	24186985	-		○	
440	145	145	BHNBR B6B210	V 1000	24074763	-		○	

d [mm]	D [mm]	H [mm]	L [mm]	Material	Design	Part No.	PU ¹⁾	US	EU
400	440	158	158	BHNBR B6B210	V 1000	24084987	-		○
	440	177	177	BHNBR B6B210	V 1000	24182287	-		○
	450	15	3	88 NBR 101	H MF	10526	-		○
	460	150	150	BHNBR B6B210	V 1000	24067618	-		○
405	445	145	145	BHNBR B6B210	V 1000	527314	-		○
406,4	444,5	138	138	BHNBR B6B210	V 1000	24340035	-		○
	450,9	152,5	152,5	BHNR B6A151	V 1000	24353811	-		○
410	430	14,6	16	95 AU V142	TM 20	24357239	-		○
	434	7,6	8,1	PTFE B602 / NBR	OMS-MR	24275730	-		○
	434	7,6	8,1	PTFE B602 / FKM	OMS-MR	24344748	-		○
	434	7,6	8,1	PTFE GM201 / NBR	OMS-MR	24275910	-		○
	434	7,6	8,1	PTFE B602 / NBR	OMS-MR PR	49007163	-		○
	440	14	15	PTFE GM201	OMS-S	24197943	-		○
	440	14	15	PTFE GM201	OMS-S PR	49045104	-		○
	440	52,5	52,5	BHNBR B4B210	ES	24219006	-		○
	440	54	52,5	BHNBR B4B210	ES	24218594	-		○
	440	60	60	BHNBR B4B210	ES	24219007	-		○
	440	61,5	60	BHNBR B4B210	ES	24116167	-		○
	445	60	60	BHNBR B4B210	ES	24114451	-		○
	450	70	70	BHNBR B4B210	ES	24108466	-		○
	450	70	70	BHNBR B4B210	ES	24219008	-		○
	450	71,5	70	BHNBR B4B210	ES	24140331	-		○
	450	71,5	70	BHNBR B4B210	ES	24218595	-		○
	450	79	79	BHNBR B4B210	ES	24219009	-		○
	450	79	79	BHNBR B4B210	ES	24219204	-		○
	450	80	80	BHNBR B4B210	ES	24196025	-		○
	450	80	80	BHNBR B4B210	ES	24219010	-		○
	450	80,5	79	BHNBR B4B210	ES	24218596	-		○
	450	80,5	79	BHNBR B4B210	ES	24218780	-		○
	450	81,5	80	BHNBR B4B210	ES	24136066	-		○
	450	81,5	80	BHNBR B4B210	ES	24218781	-		○
	450	89	89	BHNBR B4B210	ES	24219011	-		○
	450	89	89	BHNBR B4B210	ES	24219205	-		○
	450	90,5	89	BHNBR B4B210	ES	24218597	-		○
	450	90,5	89	BHNBR B4B210	ES	24218782	-		○
	450	129	129	BHNBR B6B210	V 1000	24349979	-		○
	450	145	145	BHNR B6A151	V 1000	24196194	-		○
	450	158	158	BHNR B6A151	V 1000	24234365	-		○
	460	150	150	BHNBR B6B210	V 1000	526286	-		○
415	439	7,6	8,1	PTFE B602 / NBR	OMS-MR	24379205	-		○
	455	61,5	60	BHNBR B4B210	ES	24267389	-		○
	455	81,5	80	BHNBR B4B210	ES	24128991	-		○
	465	190	190	BHNR B6A151	V 1000	24360861	-		○
416	456	129	129	BHNR B6A151	V 1000	24375513	-		○
419,1	457,2	155	155	BHNBR B6B210	V 1000	24345632	-		○
420	440	14,6	16	95 AU V142	TM 20	24379339	-		○
	444	7,6	8,1	PTFE B602 / NBR	OMS-MR	24275718	-		○
	444	7,6	8,1	PTFE B602 / FKM	OMS-MR	24344749	-		○
	444	7,6	8,1	PTFE GM201 / NBR	OMS-MR	24275882	-		○
	450	14	15	PTFE GM201	OMS-S	24224742	-		○

d [mm]	D [mm]	H [mm]	L [mm]	Material	Design	Part No.	PU ¹⁾	US	EU
	450	14	15	PTFE B602	OMS-S PR	49021387	-		○
	450	14	15	PTFE GM201	OMS-S PR	49010869	-		○
	450	15	16	90 NBR 109	N 1	17239	-		○
	450	23,7	26	93 AU V167	TMP 20	24368253	-		○
	450	23,8	26	95 AU V142	TM 20	24359756	-		○
	450	25	26,5	80 NBR B246	Seal Set 0214	24299742	-		○
	450	25	26,5	80 NBR B246	Seal Set 0216	24299741	-		○
	450	52,5	52,5	BHNBR B4B210	ES	24219012	-		○
	450	54	52,5	BHNBR B4B210	ES	24218598	-		○
	450	60	60	BHNBR B4B210	ES	24219013	-		○
	450	61,5	60	BHNBR B4B210	ES	24071213	-		○
	460	29,1	32	95 AU V142	TM 20	24359757	-		○
	460	60	60	BHNBR B4B210	ES	24098516	-		○
	460	60	60	BHNBR B4B210	ES	24289410	-		○
	460	70	70	BHNBR B4B210	ES	24109496	-		○
	460	70	70	BHNBR B4B210	ES	24134937	-		○
	460	71,5	70	BHNBR B4B210	ES	24069492	-		○
	460	71,5	70	BHNBR B4B210	ES	24074765	-		○
420	460	79	79	BHNBR B4B210	ES	24219014	-		○
	460	79	79	BHNBR B4B210	ES	24219206	-		○
	460	80	80	BHNBR B4B210	ES	24077332	-		○
	460	80	80	BHNBR B4B210	ES	24219015	-		○
	460	80,5	79	BHNBR B4B210	ES	24218599	-		○
	460	80,5	79	BHNBR B4B210	ES	24218783	-		○
	460	81,5	80	BHNBR B4B210	ES	24129597	-		○
	460	81,5	80	BHNBR B4B210	ES	24218784	-		○
	460	81,5	89	BHNBR B4B210	ES	24218785	-		○
	460	89	89	BHNBR B4B210	ES	24219016	-		○
	460	89	89	BHNBR B4B210	ES	24219207	-		○
	460	90,5	89	BHNBR B4B210	ES	24218600	-		○
	460	115	115	BHNBR B6B210	V 1000	24356723	-		○
	460	126	126	BHNBR B6B210	V 1000	24081749	-		○
	460	128	128	BHNBR B6B210	V 1000	24132945	-		○
	460	145	145	BHNBR B6B210	V 1000	24141625	-		○
	460	158	158	BHNBR B6A151	V 1000	24187012	-		○
	460	160	160	BHNBR B6B210	V 1000	24145021	-		○
	470	18	4	88 NBR 101	H MF	10532	-		○
	449	7,6	8,1	PTFE B602/NBR	OMS-MR	24355467	-		○
	465	70	70	BHNBR B4B210	ES	24090496	-		○
425	465	71,5	70	BHNBR B4B210	ES	24121155	-		○
	465	81,5	80	BHNBR B4B210	ES	24083265	-		○
	465	128	128	BHNBR B6B210	V 1000	24089066	-		○
	475	170	170	BHNBR B6B210	V 1000	24328801	-		○
	454	7,6	8,1	PTFE B602/NBR	OMS-MR	24275744	IP		●
	454	7,6	8,1	PTFE B602/FKM	OMS-MR	24344750	-		○
	454	7,6	8,1	PTFE GM201/NBR	OMS-MR	24275870	-		○
430	454	7,6	8,1	PTFE C104/NBR	OMS-MR PR	49043923	-		○
	460	14	15	PTFE GM201	OMS-S	24224749	-		○
	460	22,8	25	95 AU V142	TM 20	24359758	-		○
	460	52,5	52,5	BHNBR B4B210	ES	24219017	-		○

d [mm]	D [mm]	H [mm]	L [mm]	Material	Design	Part No.	PU ¹⁾	US	EU
430	460	54	52,5	BHNBR B4B210	ES	24218601	-		○
	460	60	60	BHNBR B4B210	ES	24219018	-		○
	460	61,5	60	BHNBR B4B210	ES	24218602	-		○
	462	80	80	BHNBR B5B210	V 1000	24290411	-		○
	468,1	137	137	BHNBR B6B210	V 1000	24315093	-		○
	470	60	60	BHNBR B4B210	ES	24298359	-		○
	470	61,5	60	BHNBR B4B210	ES	24082970	-		○
	470	70	70	BHNBR B4B210	ES	24219019	-		○
	470	71,5	70	BHNBR B4B210	ES	24177234	-		○
	470	79	79	BHNBR B4B210	ES	24219020	-		○
	470	80	80	BHNBR B4B210	ES	24219021	-		○
	470	80,5	79	BHNBR B4B210	ES	24218603	-		○
	470	81,5	80	BHNBR B4B210	ES	24097838	-		○
	470	89	89	BHNBR B4B210	ES	24219022	-		○
	470	90,5	89	BHNBR B4B210	ES	24218604	-		○
	470	128	128	BHNBR B6B210	V 1000	24239323	-		○
	470	147	147	BHNR B6A151	V 1000	24290873	-		○
	470	160	160	BHNBR B6B210	V 1000	24241829	-		○
	431,8	455,8	7,6	8,1	PTFE B602 / NBR	OMS-MR	24342999	-	
469,9		117	117	BHNBR B6B210	V 1000	24144244	-		○
469,9		127	127	BHNBR B6B210	V 1000	24112072	-		○
469,9		127	127	BHNR B6A151	V 1000	24195079	-		○
469,9		132,1	132,1	BHNBR B6B210	V 1000	24250380	-		○
469,9		137	137	BHNR B6A151	V 1000	24193039	-		○
435	459	7,6	8,1	PTFE GM201 / NBR	OMS-MR	24308272	-		○
	465	14	15	PTFE GM201	OMS-S	526056	-		○
440	460	14,6	16	95 AU V142	TM 20	24357240	-		○
	464	7,6	8,1	PTFE B602 / NBR	OMS-MR	24275751	-		○
	464	7,6	8,1	PTFE B602 / FKM	OMS-MR	24344751	-		○
	464	7,6	8,1	PTFE GM201 / NBR	OMS-MR	24265249	-		○
	464	7,6	8,1	PTFE B602 / NBR	OMS-MR PR	49019314	-		○
	464	7,6	8,1	PTFE GM201 / NBR	OMS-MR PR	49066592	IP		●
	470	14	15	PTFE GM201	OMS-S	24193472	-		○
	470	14	15	PTFE B602	OMS-S PR	49038828	-		○
	470	22,8	25	95 AU V142	TM 20	24370501	-		○
	470	23,7	26	93 AU V167	TMP 20	526870	-		○
	470	52,5	52,5	BHNBR B4B210	ES	24219023	-		○
	470	54	52,5	BHNBR B4B210	ES	24218605	-		○
	470	60	60	BHNBR B4B210	ES	24219024	-		○
	470	61,5	60	BHNBR B4B210	ES	24218606	-		○
	480	25	26	90 NBR 109	N 1	17242	-	○	○
	480	60	60	BHNBR B4B210	ES	24072171	-		○
	480	61,5	60	BHNBR B4B210	ES	24148125	-		○
	480	70	70	BHNBR B4B210	ES	24099123	-		○
	480	70	70	BHNBR B4B210	ES	24219025	-		○
	480	71,5	70	BHNBR B4B210	ES	24137057	-		○
480	71,5	70	BHNBR B4B210	ES	24218607	-		○	
480	79	79	BHNBR B4B210	ES	24219026	-		○	
480	79	79	BHNBR B4B210	ES	24219208	-		○	
480	80	80	BHNBR B4B210	ES	24073676	-		○	

d [mm]	D [mm]	H [mm]	L [mm]	Material	Design	Part No.	PU ¹⁾	US	EU
440	480	80	80	BHNBR B4B210	ES	24219027	-		○
	480	80,5	79	BHNBR B4B210	ES	24218608	-		○
	480	80,5	79	BHNBR B4B210	ES	24218786	-		○
	480	81,5	80	BHNBR B4B210	ES	24104141	-		○
	480	81,5	80	BHNBR B4B210	ES	24218787	-		○
	480	89	89	BHNBR B4B210	ES	24219028	-		○
	480	89	89	BHNBR B4B210	ES	24219209	-		○
	480	90,5	89	BHNBR B4B210	ES	24218609	-		○
	480	90,5	89	BHNBR B4B210	ES	24218788	-		○
	480	145	145	BHNBR B6B210	V 1000	24105472	-		○
445	469	7,6	8,1	PTFE B602 / NBR	OMS-MR	49006959	-		○
	475	14	15	PTFE GM201	OMS-S	49008473	-		○
450	470	14,6	16	95 AU V142	TM 20	24359760	-		○
	474	7,6	8,1	PTFE B602 / FKM	OMS-MR	24243371	-		○
	474	7,6	8,1	PTFE B602 / NBR	OMS-MR	24275756	IP		●
	474	7,6	8,1	PTFE B602 / NBR	OMS-MR	24346723	-		○
	474	7,6	8,1	PTFE GM201 / NBR	OMS-MR	24275900	-		○
	474	7,6	8,1	PTFE B602 / NBR	OMS-MR PR	49027568	-		○
	480	14	15	PTFE B602	OMS-S	24350806	-		○
	480	14	15	PTFE GM201	OMS-S	24177002	-		○
	480	14	15	PTFE GM201	OMS-S PR	49017442	-		○
	480	22	24	95 AU V142	NRS-0503	49021808	-		○
	480	22,8	25	95 AU V142	TM 20	24359761	-		○
	480	23	25	95 AU V142	NRS-0503	24371213	-		○
	480	23,7	26	93 AU V167	TMP 20	24367970	-		○
	480	25	26	80 NBR B246	Seal Set O216	24274570	-		○
	480	52,5	52,5	BHNBR B4B210	ES	24219029	-		○
	480	54	52,5	BHNBR B4B210	ES	24218610	-		○
	480	60	60	BHNBR B4B210	ES	24219030	-		○
	480	60	60	BHFKM B4K674	ESV	49008946	-		○
	480	61,5	60	BHNBR B4B210	ES	24218611	-		○
	490	29,1	32	95 AU V142	TM 20	24359763	-		○
	490	30	32	80 NBR B246	Seal Set O214	24227265	-		○
	490	30	32	80 NBR B246	Seal Set O216	24228307	-		○
	490	60	60	BHNBR B4B210	ES	24071968	-		○
	490	60	60	BHNBR B4B210	ES	24082110	-		○
	490	61,5	60	BHNBR B4B210	ES	24083442	-		○
	490	61,5	60	BHNBR B4B210	ES	24287165	-		○
	490	70	70	BHNBR B4B210	ES	24072716	-		○
	490	70	70	BHNBR B4B210	ES	24114458	-		○
	490	71,5	70	BHNBR B4B210	ES	24149535	-		○
	490	71,5	70	BHNBR B4B210	ES	24218789	-		○
	490	79	79	BHNBR B4B210	ES	24144269	-		○
	490	79	79	BHNBR B4B210	ES	24219031	-		○
490	80	80	BHNBR B4B210	ES	24066931	-		○	
490	80	80	BHNBR B4B210	ES	24089042	-		○	
490	80,5	79	BHNBR B4B210	ES	24218612	-		○	
490	80,5	79	BHNBR B4B210	ES	24218790	-		○	
490	81,5	80	BHNBR B4B210	ES	24075890	-		○	
490	81,5	80	BHNBR B4B210	ES	24087320	-		○	

d [mm]	D [mm]	H [mm]	L [mm]	Material	Design	Part No.	PU ¹⁾	US	EU
	490	89	89	BHNBR B4B210	ES	24219032	-		○
	490	89	89	BHNBR B4B210	ES	24219210	-		○
	490	90,5	89	BHNBR B4B210	ES	24021861	-		○
	490	90,5	89	BHNBR B4B210	ES	24218791	-		○
	490	115	115	BHNBR B6B210	V 1000	24100244	-		○
	490	142,2	142,2	BHNBR B6B210	V 1000	24065889	-		○
450	490	145	145	BHNBR B6B210	V 1000	24183919	-		○
	490	145	145	BHNBR B6B210	V 1000	49002882	-		○
	490	145	145	BHNR B6A151	V 1000	24082818	-		○
	490	160	160	BHNR B6A151	V 1000	24148090	-		○
	490	177	177	BHNBR B6B210	V 1000	24188288	-		○
	510	150	150	BHNBR B6B210	V 1000	24103806	-		○
	510	150	150	BHNR B6A151	V 1000	24123582	-		○
455	495	145	145	BHNR B6A151	V 1000	24377415	-		○
	495	177	177	BHNBR B6B210	V 1000	528832	-		○
457,2	495,3	141,6	141,6	BHNR B6A151	V 1000	24105140	-		○
458	488	14	15	PTFE GM201	OMS-S	24370976	-		○
	480	14,6	16	95 AU V142	TM 20	49006630	-		○
	484	7,6	8,1	PTFE B602 /NBR	OMS-MR	24275729	IP		●
	484	7,6	8,1	PTFE B602 /FKM	OMS-MR	24344752	-		○
	484	7,6	8,1	PTFE GM201 /NBR	OMS-MR	24275909	-		○
	484	7,6	8,1	PTFE B602 /NBR	OMS-MR PR	49014935	-		○
	490	14	15	PTFE B602	OMS-S	24373024	-		○
	490	14	15	PTFE GM201	OMS-S	24224740	IP		●
	490	52,5	52,5	BHNBR B4B210	ES	24219033	-		○
	490	52,5	52,5	BHNBR B4B210	ES	24219211	-		○
	490	54	52,5	BHNBR B4B210	ES	24218614	-		○
	490	54	52,5	BHNBR B4B210	ES	24218792	-		○
	490	60	60	BHNBR B4B210	ES	24219034	-		○
	490	60	60	BHNBR B4B210	ES	24219212	-		○
	490	61,5	60	BHNBR B4B210	ES	24218615	-		○
	490	61,5	60	BHNBR B4B210	ES	24218793	-		○
	500	20	21	90 NBR 109	N 1	17248	-		○
460	500	29,1	32	95 AU V142	TM 20	24374652	-		○
	500	60	60	BHNBR B4B210	ES	24235023	-		○
	500	60	60	BHNBR B4B210	ES	24355016	-		○
	500	70	70	BHNBR B4B210	ES	24219035	-		○
	500	70	70	BHNBR B4B210	ES	24219213	-		○
	500	71,5	70	BHNBR B4B210	ES	24135172	-		○
	500	71,5	70	BHNBR B4B210	ES	24148439	-		○
	500	79	79	BHNBR B4B210	ES	24138356	-		○
	500	79	79	BHNBR B4B210	ES	24219036	-		○
	500	80	80	BHNBR B4B210	ES	24219037	-		○
	500	80	80	BHNBR B4B210	ES	24219214	-		○
	500	80,5	79	BHNBR B4B210	ES	24218616	-		○
	500	80,5	79	BHNBR B4B210	ES	24218794	-		○
	500	81,5	80	BHNBR B4B210	ES	24076722	-		○
	500	81,5	80	BHNBR B4B210	ES	24188047	-		○
	500	89	89	BHNBR B4B210	ES	24079459	-		○
	500	89	89	BHNBR B4B210	ES	24219038	-		○

d [mm]	D [mm]	H [mm]	L [mm]	Material	Design	Part No.	PU ¹⁾	US	EU
460	500	90,5	89	BHNBR B4B210	ES	24218617	-		○
	500	90,5	89	BHNBR B4B210	ES	24218795	-		○
	500	113	113	BHNBR B6B210	V 1000	24140807	-		○
	500	145	145	BHNBR B6B210	V 1000	24174102	-		○
	504,5	152,5	152,5	BHNR B6A151	V 1000	24231979	-		○
	510	150	150	BHNBR B6B210	V 1000	24073241	-		○
	520	150	150	BHNBR B6B210	V 1000	24339577	-		○
	520	230	230	BHNR B6A151	V 1000	529949	-		○
460,8	510,8	190	190	BHNR B6A151	V 1000	24108621	-		○
469,9	514,4	168,4	168,4	BHNR B6A151	V 1000	24375626	-		○
470	494	7,6	8,1	PTFE B602 / NBR	OMS-MR	24269646	-		○
	494	7,6	8,1	PTFE B602 / FKM	OMS-MR	24327514	-		○
	494	7,6	8,1	PTFE B602 / FKM	OMS-MR	24344753	-		○
	494	7,6	8,1	PTFE GM201 / NBR	OMS-MR	24275881	-		○
	494	7,6	8,1	PTFE B602 / NBR	OMS-MR PR	49014936	-		○
	494	7,6	8,1	PTFE C104 / NBR	OMS-MR PR	49017641	-		○
	500	14	15	PTFE B602	OMS-S	24342901	-		○
	500	14	15	PTFE GM201	OMS-S	24137929	-		○
	500	14	15	PTFE GM201	OMS-S	24315325	-		○
	500	52,5	52,5	BHNBR B4B210	ES	24219043	-		○
	500	54	52,5	BHNBR B4B210	ES	24218622	-		○
	500	60	60	BHNBR B4B210	ES	24114088	-		○
	500	61,5	60	BHNBR B4B210	ES	24218623	-		○
	500	61,5	60	BHNBR B4B210	ES	24218799	-		○
	510	60	60	BHNBR B4B210	ES	24077623	-		○
	510	60	60	BHNBR B4B210	ES	24328827	-		○
	510	61,5	60	BHNBR B4B210	ES	24261800	-		○
	510	70	70	BHNBR B4B210	ES	24086461	-		○
	510	71,5	70	BHNBR B4B210	ES	24218624	-		○
	510	71,5	70	BHNBR B4B210	ES	24218800	-		○
	510	79	79	BHNBR B4B210	ES	24219046	-		○
	510	79	79	BHNBR B4B210	ES	24219219	-		○
	510	80	80	BHNBR B4B210	ES	24086152	-		○
	510	80	80	BHNBR B4B210	ES	24102327	-		○
	510	80,5	79	BHNBR B4B210	ES	24218625	-		○
	510	80,5	79	BHNBR B4B210	ES	24218801	-		○
	510	81,5	80	BHNBR B4B210	ES	24073484	-		○
	510	81,5	80	BHNBR B4B210	ES	24218626	-		○
	510	89	89	BHNBR B4B210	ES	24219220	-		○
	510	90,5	89	BHNBR B4B210	ES	24218627	-		○
	510	90,5	89	BHNBR B4B210	ES	24218802	-		○
	520	102	100	BHNBR B4B210	ES	24195501	-		○
475	499	7,6	8,1	PTFE B602 / NBR	OMS-MR	49018009	-		○
	505	61,5	60	BHNBR B4B210	ES	24350425	-		○
	515	30	32	80 NBR B246	Seal Set 0216	24234174	-		○
	515	61,5	60	BHNBR B4B210	ES	24266457	-		○
	515	71,5	70	BHNBR B4B210	ES	24191587	-		○
	515	81,5	80	BHNBR B4B210	ES	24076698	-		○
476	526	165	165	BHNR B6A151	V 1000	24343744	-		○
476	526	165	165	BHNBR B6B210	V 1000	24268974	-		○

d [mm]	D [mm]	H [mm]	L [mm]	Material	Design	Part No.	PU ¹⁾	US	EU
	500	14,6	16	95 AU V142	TM 20	24357241	IP		●
	504	7,6	8,1	PTFE B602 /NBR	OMS-MR	24268686	IP		●
	504	7,6	8,1	PTFE B602 /FKM	OMS-MR	24344754	-		○
	504	7,6	8,1	PTFE GM201 /NBR	OMS-MR	24268688	-		○
	504	7,6	8,1	PTFE B602 /NBR	OMS-MR PR	49054816	-		○
	504	7,6	8,1	PTFE GM201 /NBR	OMS-MR PR	49054629	IP		●
	510	14	15	PTFE B602	OMS-S	24338028	-		○
	510	14	15	PTFE GM201	OMS-S	24193226	-		○
	510	52,5	52,5	BHNBR B4B210	ES	24219048	-		○
	510	54	52,5	BHNBR B4B210	ES	24218628	-		○
	510	60	60	BHNBR B4B210	ES	24219049	-		○
	510	61,5	60	BHNBR B4B210	ES	24218629	-		○
	520	30	32	80 NBR B246	Seal Set 0214	24245108	-		○
	520	30	32	80 NBR B246	Seal Set 0216	24232822	-		○
	520	60	60	BHNBR B4B210	ES	24067704	-		○
	520	61,5	60	BHNBR B4B210	ES	24234854	-		○
	520	70	70	BHNBR B4B210	ES	24105043	-		○
	520	70	70	BHNBR B4B210	ES	24219050	-		○
480	520	71,5	70	BHNBR B4B210	ES	24088276	-		○
	520	71,5	70	BHNBR B4B210	ES	24218803	-		○
	520	79	79	BHNBR B4B210	ES	24219051	-		○
	520	79	79	BHNBR B4B210	ES	24219221	-		○
	520	80	80	BHNBR B4B210	ES	24073331	-		○
	520	80	80	BHNBR B4B210	ES	24219052	-		○
	520	80,5	79	BHNBR B4B210	ES	24218630	-		○
	520	80,5	79	BHNBR B4B210	ES	24218804	-		○
	520	81,5	80	BHNBR B4B210	ES	24083647	-		○
	520	81,5	80	BHNBR B4B210	ES	24097319	-		○
	520	89	89	BHNBR B4B210	ES	24219053	-		○
	520	89	89	BHNBR B4B210	ES	24219222	-		○
	520	90,5	89	BHNBR B4B210	ES	24218631	-		○
	520	90,5	89	BHNBR B4B210	ES	24218805	-		○
	520	145	145	BHNBR B6B210	V 1000	24181798	-		○
	520	177	177	BHNBR B6B210	V 1000	24297826	-		○
	530	180	180	BHNBR B6B210	V 1000	24358270	-		○
	530	185	185	BHNBR B6B210	V 1000	24343108	-		○
	530	190	190	BHNBR B6B210	V 1000	24346601	-		○
485	509	7,6	8,1	PTFE B602 /NBR	OMS-MR	24352001	-		○
	509	7,6	8,1	PTFE GM201 /NBR	OMS-MR	24344483	-		○
	514	7,6	8,1	PTFE B602 /NBR	OMS-MR	24269412	-		○
	514	7,6	8,1	PTFE B602 /FKM	OMS-MR	24344755	-		○
	514	7,6	8,1	PTFE GM201 /NBR	OMS-MR	24275869	-		○
	514	7,6	8,1	PTFE B602 /NBR	OMS-MR PR	49037293	-		○
	520	14	15	PTFE GM201	OMS-S	24224738	-		○
490	520	14	15	PTFE GM201	OMS-S PR	49022435	-		○
	520	52,5	52,5	BHNBR B4B210	ES	24219054	-		○
	520	54	52,5	BHNBR B4B210	ES	24218632	-		○
	520	60	60	BHNBR B4B210	ES	24219055	-		○
	520	61,5	60	BHNBR B4B210	ES	24149532	-		○
	530	70	70	BHNBR B4B210	ES	24219056	-		○

d [mm]	D [mm]	H [mm]	L [mm]	Material	Design	Part No.	PU ¹⁾	US	EU
490	530	71,5	70	BHNBR B4B210	ES	24218633	-		○
	530	71,5	70	BHNBR B4B210	ES	24218806	-		○
	530	79	79	BHNBR B4B210	ES	24219057	-		○
	530	80	80	BHNBR B4B210	ES	24219058	-		○
	530	80,5	79	BHNBR B4B210	ES	24218634	-		○
	530	80,5	79	BHNBR B4B210	ES	24218807	-		○
	530	81,5	80	BHNBR B4B210	ES	24077972	-		○
	530	81,5	80	BHNBR B4B210	ES	24218808	-		○
	530	89	89	BHNBR B4B210	ES	24219059	-		○
	530	90,5	89	BHNBR B4B210	ES	24218635	-		○
	530	90,5	89	BHNBR B4B210	ES	24218809	-		○
	530	179	179	BHNR B6A151	V 1000	24370249	-		○
	495	519	7,6	8,1	PTFE B602/NBR	OMS-MR	24267645	-	
495,3	533,4	121,3	121,3	BHNBR B6B210	V 1000	24172098	-		○
	533,4	152,4	152,4	BHNBR B6B210	V 1000	24232303	-		○
497	547	190	190	BHNR B6A151	V 1000	24339742	-		○
498	522	7,6	8,1	PTFE B602/NBR	OMS-MR	24358445	-		○
500	520	14,6	16	93 AU V167	TM 20	24359767	-		○
	520	14,6	16	94 AU 925	TM 20	49017450	-		○
	524	7,6	8,1	PTFE B602/NBR	OMS-MR	24264956	IP		●
	524	7,6	8,1	PTFE B602/FKM	OMS-MR	24357274	-		○
	524	7,6	8,1	PTFE C104/NBR	OMS-MR	49055699	-		○
	524	7,6	8,1	PTFE GM201/NBR	OMS-MR	24275911	-		○
	524	7,6	8,1	PTFE B602/NBR	OMS-MR PR	49015337	-		○
	530	14	15	PTFE GM201	OMS-S PR	49008121	-		○
	530	15	15	PTFE GM201	OMS-S	24135188	IP		●
	530	22,8	25	93 AU V168	TM 20	24359768	-		○
	530	23,7	26	93 AU V167	TMP 20	24368255	-		○
	530	25	26,5	80 NBR B246	Seal Set O216	24289342	-		○
	530	54	52,5	BHNBR B4B210	ES	24135092	-		○
	540	29,1	32	93 AU V168	TM 20	24359769	-		○
	540	30	32	80 NBR B246	Seal Set O214	24245110	-		○
	540	60	60	BHNBR B4B210	ES	24073680	-		○
	540	60	60	BHNBR B4B210	ES	24289408	-		○
	540	61,5	60	BHNBR B4B210	ES	24101974	-		○
	540	70	70	BHNBR B4B210	ES	24078095	-		○
	540	70	70	BHNBR B4B210	ES	24219060	-		○
	540	71,5	70	BHNBR B4B210	ES	24071463	-		○
	540	71,5	70	BHNBR B4B210	ES	24122836	-		○
	540	79	79	BHNBR B4B210	ES	24219061	-		○
	540	79	79	BHNBR B4B210	ES	24219223	-		○
	540	80	80	BHNBR B4B210	ES	24069526	-		○
	540	80	80	BHNBR B4B210	ES	24075177	-		○
	540	80,5	79	BHNBR B4B210	ES	24218636	-		○
	540	80,5	79	BHNBR B4B210	ES	24232446	-		○
	540	81,5	80	BHNBR B4B210	ES	24084839	-		○
	540	81,5	80	BHNBR B4B210	ES	24089167	-		○
	540	89	89	BHNBR B4B210	ES	24219062	-		○
	540	89	89	BHNBR B4B210	ES	24219224	-		○
	540	90,5	89	BHNBR B4B210	ES	24218637	-		○

d [mm]	D [mm]	H [mm]	L [mm]	Material	Design	Part No.	PU ¹⁾	US	EU
500	540	90,5	89	BHNBR B4B210	ES	24218810	-		○
	540	145	145	BHNBR B6B210	V 1000	24131965	-		○
	540	179	179	BHNBR B6B210	V 1000	24173186	-		○
	544,4	152,5	152,5	BHNR B6A151	V 1000	24302825	-		○
	550	100	100	BHNBR B4B210	ES	24219064	-		○
	550	102	100	BHNBR B4B210	ES	24021863	-		○
	560	150	150	BHNBR B6B210	V 1000	24096077	-		○
501,7	546,2	181,1	181,1	BHNR B6A151	V 1000	24149032	-		○
508	532	7,6	8,1	PTFE B602/NBR	OMS-MR	24351659	-		○
510	534	7,6	8,1	PTFE B602/NBR	OMS-MR	24275750	-		○
	534	7,6	8,1	PTFE B602/FKM	OMS-MR	24344757	-		○
	534	7,6	8,1	PTFE GM201/NBR	OMS-MR	24275908	-		○
	534	7,6	8,1	PTFE B602/NBR	OMS-MR PR	49038731	-		○
	545	16,4	17,5	PTFE GM201	OMS-S	24199480	-		○
	545	16,4	17,5	PTFE B602	OMS-S PR	49038862	-		○
	550	61,5	60	BHNBR B4B210	ES	24124812	IP		●
	550	70	70	BHNBR B4B210	ES	24111575	-		○
	550	70	70	BHNBR B4B210	ES	24266458	-		○
	550	71,5	70	BHNBR B4B210	ES	24087359	-		○
	550	81,5	80	BHNBR B4B210	ES	24287922	-		○
	560	100	100	BHNBR B4B210	ES	24082070	-		○
	560	100	100	BHNBR B4B210	ES	24219068	-		○
	560	102	100	BHNBR B4B210	ES	24124279	-		○
	560	102	100	BHNBR B4B210	ES	24218642	-		○
570	150	150	BHNBR B6B210	V 1000	24069252	-		○	
515	539	7,6	8,1	PTFE B602/NBR	OMS-MR	24339493	-		○
	565	200	200	BHNBR B6B210	V 1000	24180280	-		○
520	540	14,6	16	94 AU 925	TM 20	49015056	-		○
	544	7,6	8,1	PTFE B602/NBR	OMS-MR	24275716	-		○
	544	7,6	8,1	PTFE B602/FKM	OMS-MR	24344758	-		○
	544	7,6	8,1	PTFE GM201/NBR	OMS-MR	24275899	-		○
	544	7,6	8,1	PTFE B602/NBR	OMS-MR PR	49014937	-		○
	544	7,6	8,1	PTFE GM201/NBR	OMS-MR PR	49058182	-		○
	550	60	60	BHNBR B4B210	ES	24246917	-		○
	555	16,4	17,5	PTFE B602	OMS-S	24349777	-		○
	555	16,4	17,5	PTFE GM201	OMS-S	24198653	-		○
	560	29,1	32	93 AU V168	TM 20	24359770	-		○
	560	61,5	60	BHNBR B4B210	ES	24250502	-		○
	560	70	70	BHNBR B4B210	ES	24219069	-		○
	560	71,5	70	BHNBR B4B210	ES	24098086	-		○
	560	80	80	BHNBR B4B210	ES	24080048	-		○
	560	81,5	80	BHNBR B4B210	ES	24096048	-		○
	570	100	100	BHNBR B4B210	ES	24183857	-		○
	570	102	100	BHNBR B4B210	ES	24218644	-		○
	570	160	160	BHNBR B6B210	V 1000	24339685	-		○
	570	160	160	BHNR B6A151	V 1000	24121575	-		○
570	190	190	BHNBR B6B210	V 1000	24179325	-		○	
580	150	150	BHNBR B6B210	V 1000	24228623	-		○	
525	565	18,7	20	PTFE B602	OMS-S	49002965	-		○
	565	81,5	80	BHNBR B4B210	ES	24147763	-		○

d [mm]	D [mm]	H [mm]	L [mm]	Material	Design	Part No.	PU ¹⁾	US	EU
	554	7,6	8,1	PTFE B602 / NBR	OMS-MR	24275728	-		○
	554	7,6	8,1	PTFE B602 / FKM	OMS-MR	24344759	-		○
	554	7,6	8,1	PTFE B602 / FKM	OMS-MR	24357275	-		○
	554	7,6	8,1	PTFE GM201 / NBR	OMS-MR	24275880	-		○
	554	7,6	8,1	PTFE B602 / NBR	OMS-MR PR	49014247	-		○
	554	7,6	8,1	PTFE GM201 / NBR	OMS-MR PR	49033643	-		○
	560	22,8	25	93 AU V168	TM 20	24359771	-		○
	560	25	26,5	80 NBR B246	Seal Set O214	24293085	-		○
	560	25	26,5	80 NBR B246	Seal Set O216	24293086	-		○
	565	16,4	17,5	PTFE GM201	OMS-S PR	49026032	-		○
	570	60	60	BHNBR B4B210	ES	24214284	-		○
530	570	70	70	BHNBR B4B210	ES	24219071	-		○
	570	70	70	BHNBR B4B210	ES	24219226	-		○
	570	71,5	70	BHNBR B4B210	ES	24109362	-		○
	570	71,5	70	BHNBR B4B210	ES	24218812	-		○
	570	80	80	BHNBR B4B210	ES	24219072	-		○
	570	80	80	BHNBR B4B210	ES	24219227	-		○
	570	81,5	80	BHNBR B4B210	ES	24071221	-		○
	570	81,5	80	BHNBR B4B210	ES	24218813	-		○
	580	100	100	BHNBR B4B210	ES	24114578	-		○
	580	100	100	BHNBR B4B210	ES	24184291	-		○
	580	102	100	BHNBR B4B210	ES	24218815	-		○
	580	190	190	BHNBR B6B210	V 1000	24290849	-		○
531	585	190	190	BHNBR B6B210	V 1000	24372362	-		○
533,4	577,9	184,3	184,3	BHNBR B6B210	V 1000	24259420	-		○
535	575	60	60	BHNBR B4B210	ES	24339801	-		○
	560	14,6	16	94 AU 925	TM 20	49066449	-		○
	564	7,6	8,1	PTFE B602 / NBR	OMS-MR	24261155	-		○
	564	7,6	8,1	PTFE B602 / FKM	OMS-MR	24344760	-		○
	564	7,6	8,1	PTFE GM201 / NBR	OMS-MR	24275868	-		○
	564	7,6	8,1	PTFE B602 / NBR	OMS-MR PR	49034165	-		○
	575	16,4	17,5	PTFE GM201	OMS-S	24224759	IP		●
	575	16,4	17,5	PTFE GM201	OMS-S PR	49030424	-		○
	580	29,1	32	93 AU V168	TM 20	24359772	-		○
	580	30	32	80 NBR B246	Seal Set O216	24288874	-		○
	580	60	60	BHNBR B4B210	ES	24145861	-		○
540	580	61,5	60	BHNBR B4B210	ES	24250612	-		○
	580	70	70	BHNBR B4B210	ES	24219074	-		○
	580	70	70	BHNBR B4B210	ES	24219228	-		○
	580	71,5	70	BHNBR B4B210	ES	24218645	-		○
	580	71,5	70	BHNBR B4B210	ES	24218816	-		○
	580	80	80	BHNBR B4B210	ES	24075336	-		○
	580	80	80	BHNBR B4B210	ES	24170936	-		○
	580	81,5	80	BHNBR B4B210	ES	24076138	-		○
	580	81,5	80	BHNBR B4B210	ES	24218817	-		○
	580	90,5	89	BHNBR B4B210	ES	24251957	-		○
	590	166	166	BHNBR B6B210	V 1000	24314230	-		○
	590	190	190	BHNBR B6B210	V 1000	24240751	-		○
545	569	7,6	8,1	PTFE C104 / NBR	OMS-MR PR	49035524	-		○
	580	16,4	17,5	PTFE GM201	OMS-S	49001641	-		○

d [mm]	D [mm]	H [mm]	L [mm]	Material	Design	Part No.	PU ¹⁾	US	EU
545	585	81,5	80	BHNBR B4B210	ES	24198570	-		○
550	570	14,6	16	93 AU V168	TM 20	24357242	-		○
	574	7,6	8,1	PTFE B602/NBR	OMS-MR	24234533	-		○
	574	7,6	8,1	PTFE B602/FKM	OMS-MR	24344761	-		○
	574	7,6	8,1	PTFE GM201/NBR	OMS-MR	24233563	-		○
	574	7,6	8,1	PTFE B602/NBR	OMS-MR PR	49054769	-		○
	585	16,4	17,5	PTFE B602	OMS-S	24362481	-		○
	585	16,4	17,5	PTFE GM201	OMS-S	24191359	IP		●
	590	29,1	32	93 AU V168	TM 20	24359204	-		○
	590	60	60	BHNBR B4B210	ES	24067721	-		○
	590	61,5	60	BHNBR B4B210	ES	24146457	-		○
	590	70	70	BHNBR B4B210	ES	24099983	-		○
	590	70	70	BHNBR B4B210	ES	24114443	-		○
	590	71,5	70	BHNBR B4B210	ES	24093548	-		○
	590	71,5	70	BHNBR B4B210	ES	24218818	-		○
	590	80	80	BHNBR B4B210	ES	24068523	-		○
	590	80	80	BHNBR B4B210	ES	24076184	-		○
	590	81,5	80	BHNBR B4B210	ES	24092719	-		○
	590	81,5	80	BHNBR B4B210	ES	24118024	-		○
	590	147	147	BHNBR B6B210	V 1000	24232031	-		○
	610	150	150	BHNR B6A151	V 1000	24243658	-		○
610	190	190	BHNR B6A151	V 1000	24198923	-		○	
612	193	193	BHNR B6A151	V 1000	24217533	-		○	
555	579	7,6	8,1	PTFE B602/NBR	OMS-MR	24314953	-		○
	595	70	70	BHNBR B4B210	ES	24219077	-		○
	595	70	70	BHNBR B4B210	ES	24219229	-		○
	595	71,5	70	BHNBR B4B210	ES	24218819	-		○
	595	80	80	BHNBR B4B210	ES	24219078	-		○
	595	80	80	BHNBR B4B210	ES	24219230	-		○
	595	81,5	80	BHNBR B4B210	ES	24218647	-		○
	595	81,5	80	BHNBR B4B210	ES	24218820	-		○
	610	163	163	BHNR B6A151	V 1000	24178288	-		○
	610	200	200	BHNBR B6B210	V 1000	532613	-		○
558	610	198	198	BHNBR B6B210	V 1000	24377386	-		○
	612	190	190	BHNBR B6B210	V 1000	49004105	-		○
558,8	582,8	7,6	8,1	PTFE B602/NBR	OMS-MR	24361618	-		○
560	580	14,6	16	94 AU 925	TM 20	49066450	-		○
	584	7,6	8,1	PTFE B602/FKM	OMS-MR	24263331	-		○
	584	7,6	8,1	PTFE B602/NBR	OMS-MR	24275702	-		○
	584	7,6	8,1	PTFE GM201/NBR	OMS-MR	24243496	-		○
	584	7,6	8,1	PTFE B602/NBR	OMS-MR PR	49033893	-		○
	595	16,4	17,5	PTFE B602	OMS-S	24349743	-		○
	595	16,4	17,5	PTFE GM201	OMS-S	24224747	IP		●
	600	25	26	80 NBR B246	Seal Set 0214	24287009	-		○
	600	25	26	80 NBR B246	Seal Set 0216	24287008	-		○
	600	29,1	32	93 AU V168	TM 20	24359773	-		○
	600	60	60	BHNBR B4B210	ES	24067725	-		○
	600	61,5	60	BHNBR B4B210	ES	24146345	-		○
	600	70	70	BHNBR B4B210	ES	24079662	-		○
	600	70	70	BHNBR B4B210	ES	24219079	-		○

d [mm]	D [mm]	H [mm]	L [mm]	Material	Design	Part No.	PU ¹⁾	US	EU
560	600	71,5	70	BHNBR B4B210	ES	24079390	-		○
	600	71,5	70	BHNBR B4B210	ES	24218821	-		○
	600	80	80	BHNBR B4B210	ES	24066933	-		○
	600	80	80	BHNBR B4B210	ES	24219080	-		○
	600	81,5	80	BHNBR B4B210	ES	24064031	-		○
	600	81,5	80	BHNBR B4B210	ES	24071225	-		○
	600	90,5	89	BHNBR B4B210	ES	24244771	-		○
	610	100	100	BHNBR B4B210	ES	24066944	-		○
	610	102	100	BHNBR B4B210	ES	24218823	-		○
	610	150	150	BHNBR B6B210	V 1000	24099753	-		○
	610	160	160	BHNR B6A151	V 1000	24339092	-		○
	610	190	190	BHNBR B6B210	V 1000	24066993	-		○
	610	190	190	BHNR B6A151	V 1000	24086022	-		○
	610	195	195	BHNBR B6B210	V 1000	24069335	-		○
565	605	147	147	BHNBR B6B210	V 1000	24227111	-		○
568	608	190	190	BHNR B6A151	V 1000	24079970	-		○
570	594	7,6	8,1	PTFE B602 / NBR	OMS-MR	24275715	-		○
	594	7,6	8,1	PTFE B602 / FKM	OMS-MR	24344762	-		○
	594	7,6	8,1	PTFE GM201 / NBR	OMS-MR	24275898	-		○
	594	7,6	8,1	PTFE GM201 / NBR	OMS-MR PR	49041458	-		○
	605	16,4	17,5	PTFE GM201	OMS-S	24224756	-		○
	605	16,4	17,5	PTFE C104	OMS-S PR	49024945	-		○
	605	16,4	17,5	PTFE GM201	OMS-S PR	49017443	-		○
	610	71,5	70	BHNBR B4B210	ES	24243007	-		○
	610	80	80	BHNBR B4B210	ES	24343524	-		○
	610	81,5	80	BHNBR B4B210	ES	24101408	-		○
	614,5	165,2	165,2	BHNR B6A151	V 1000	24340589	-		○
	620	190	190	BHNBR B6B210	V 1000	24097638	-		○
	620	199,5	199,5	BHNR B6A151	V 1000	24217660	-		○
	620	230	230	BHNBR B6B210	V 1000	24102920	-		○
571,5	609,6	152,4	152,4	BHNBR B6B210	V 1000	24144714	-		○
580	600	14,6	16	94 AU 925	TM 20	49066451	-		○
	604	7,6	8,1	PTFE B602 / NBR	OMS-MR	24275732	IP		●
	604	7,6	8,1	PTFE B602 / FKM	OMS-MR	24344763	-		○
	604	7,6	8,1	PTFE GM201 / NBR	OMS-MR	24275907	-		○
	610	22,8	25	93 AU V168	TM 20	49001720	-		○
	615	16,4	17,5	PTFE GM201	OMS-S	24224760	-		○
	615	16,4	17,5	PTFE GM201	OMS-S PR	49015661	-		○
	620	29,1	32	93 AU V168	TM 20	24359774	-		○
	620	30	32	80 NBR B246	Seal Set O214	24245106	-		○
	620	30	32	80 NBR B246	Seal Set O216	24234580	-		○
	620	60	60	BHNBR B4B210	ES	24330921	-		○
	620	60	60	BHNBR B4B210	ES	24340889	-		○
	620	61,5	60	BHNBR B4B210	ES	24268708	-		○
	620	70	70	BHNBR B4B210	ES	24114437	-		○
	620	70	70	BHNBR B4B210	ES	24219083	-		○
	620	71,5	70	BHNBR B4B210	ES	24218824	-		○
	620	71,5	70	BHNBR B4B210	ES	24233518	-		○
	620	80	80	BHNBR B4B210	ES	24114580	-		○
	620	80	80	BHNBR B4B210	ES	24145786	-		○

d [mm]	D [mm]	H [mm]	L [mm]	Material	Design	Part No.	PU ¹⁾	US	EU	
	620	81,5	80	BHNBR B4B210	ES	24218649	-		○	
	620	81,5	80	BHNBR B4B210	ES	24218825	-		○	
	620	143	143	BHNR B6A151	V 1000	24099077	-		○	
580	630	100	100	BHNBR B4B210	ES	24219231	-		○	
	630	102	100	BHNBR B4B210	ES	24107260	-		○	
	630	102	100	BHNBR B4B210	ES	24218827	-		○	
	630	150	150	BHNBR B6B210	V 1000	24214757	-		○	
	630	200	200	BHNBR B6B210	V 1000	24300598	-		○	
	584,2	622,3	160	160	BHNBR B6B210	V 1000	24352074	-		○
		614	7,6	8,1	PTFE B602 /NBR	OMS-MR	24275727	-		○
	614	7,6	8,1	PTFE B602 /FKM	OMS-MR	24316068	-		○	
	614	7,6	8,1	PTFE B602 /FKM	OMS-MR	24344764	-		○	
	614	7,6	8,1	PTFE GM201 /NBR	OMS-MR	24275879	-		○	
	614	7,6	8,1	PTFE C104 /NBR	OMS-MR PR	49020078	-		○	
590	625	16,4	17,5	PTFE B602	OMS-S	24342902	-		○	
	625	16,4	17,5	PTFE GM201	OMS-S	24224753	-		○	
	630	60	60	BHNBR B4B210	ES	24114340	-		○	
	630	70	70	BHNBR B4B210	ES	24091257	-		○	
	630	70	70	BHNBR B4B210	ES	24219084	-		○	
	630	71,5	70	BHNBR B4B210	ES	24218651	-		○	
	630	71,5	70	BHNBR B4B210	ES	24218828	-		○	
	630	80	80	BHNBR B4B210	ES	24083741	-		○	
	630	81,5	80	BHNBR B4B210	ES	24009812	-		○	
	630	81,5	80	BHNBR B4B210	ES	24218829	-		○	
	640	200	200	BHNBR B6B210	V 1000	24331159	-		○	
	596,9	631,9	16,4	17,5	PTFE GM201	OMS-S	24236374	-		○
		620	14,6	16	93 AU V168	TM 20	24359775	-		○
		620	14,6	16	94 AU 925	TM 20	49029053	-		○
	624	7,6	8,1	PTFE B602 /NBR	OMS-MR	24275742	-		○	
	624	7,6	8,1	PTFE B602 /FKM	OMS-MR	24344765	-		○	
	624	7,6	8,1	PTFE GM201 /NBR	OMS-MR	24275867	-		○	
	624	7,6	8,1	PTFE B602 /NBR	OMS-MR PR	49016703	-		○	
	630	22,8	25	93 AU V168	TM 20	24359776	-		○	
	630	25	26	80 NBR B246	Seal Set O216	24275198	-		○	
	630	52,5	52,5	BHNBR B4B210	ES	24199064	-		○	
600	635	16,4	17,5	PTFE B602	OMS-S	24299660	-		○	
	635	16,4	17,5	PTFE GM201	OMS-S	24224745	IP		●	
	640	28	30	94 AU 925	NRS-0503	49032832	-		○	
	640	29,1	32	93 AU V168	TM 20	24359777	-		○	
	640	30	32	80 NBR B246	Seal Set O216	24237292	-		○	
	640	60	60	BHNBR B4B210	ES	24116145	-		○	
	640	70	70	BHNBR B4B210	ES	24078738	-		○	
	640	70	70	BHNBR B4B210	ES	24219086	-		○	
	640	71,5	70	BHNBR B4B210	ES	24063849	-		○	
	640	71,5	70	BHNBR B4B210	ES	24232447	-		○	
	640	80	80	BHNBR B4B210	ES	24219232	-		○	
	640	81,5	80	BHNBR B4B210	ES	24068954	-		○	
	640	81,5	80	BHNBR B4B210	ES	24071227	-		○	
	650	100	100	BHNBR B4B210	ES	24219089	-		○	
	650	102	100	BHNBR B4B210	ES	24132508	-		○	

d [mm]	D [mm]	H [mm]	L [mm]	Material	Design	Part No.	PU ¹⁾	US	EU
600	650	102	100	BHNBR B4B210	ES	24218831	-		○
	650	166	166	BHNBR B6B210	V 1000	24336682	-		○
	650	175	175	BHNBR B6B210	V 1000	526998	-		○
	650	190	190	BHNBR B6B210	V 1000	24367556	-		○
	650	190	190	BHNR B6A151	V 1000	24199286	-		○
	650	200	200	BHNBR B6B210	V 1000	24346636	-		○
	650	230	230	BHNBR B6B210	V 1000	24128599	-		○
605	640	16,4	17,5	PTFE GM201	OMS-S	24377267	-		○
	655	190	190	BHNBR B6B210	V 1000	24187840	-		○
	655	195	195	BHNBR B6B210	V 1000	24297813	-		○
607	660	190	190	BHNBR B6B210	V 1000	24116299	-		○
609,6	654,1	140,7	140,7	BHNBR B6B210	V 1000	24128385	-		○
610	634	7,6	8,1	PTFE B602/NBR	OMS-MR	24275703	-		○
	634	7,6	8,1	PTFE B602/FKM	OMS-MR	24344766	-		○
	634	7,6	8,1	PTFE GM201/NBR	OMS-MR	24275890	-		○
	645	16,4	17,5	PTFE GM201	OMS-S	49068069	-		○
	650	70	70	BHNBR B4B210	ES	24316425	-		○
	650	80	80	BHNBR B4B210	ES	24222956	-		○
	650	81,5	80	BHNBR B4B210	ES	24351998	-		○
	660	170	170	BHNBR B6B210	V 1000	24378950	-		○
620	660	200	200	BHNBR B6B210	V 1000	24135211	-		○
	640	14,6	16	93 AU V168	TM 20	24359551	-		○
	644	7,6	8,1	PTFE B602/NBR	OMS-MR	24275714	-		○
	644	7,6	8,1	PTFE B602/FKM	OMS-MR	24344767	-		○
	644	7,6	8,1	PTFE GM201/NBR	OMS-MR	24275897	-		○
	645	18,2	20	94 AU 925	TM 20	49066482	-		○
	650	52,5	52,5	BHNBR B4B210	ES	24346337	-		○
	655	16,4	17,5	PTFE GM201	OMS-S	24186170	-		○
	655	16,4	17,5	PTFE C104	OMS-S PR	49027857	-		○
	655	16,4	17,5	PTFE GM201	OMS-S PR	49014784	-		○
	660	61,5	60	BHNBR B4B210	ES	24291254	-		○
	660	70	70	BHNBR B4B210	ES	24219092	-		○
	660	71,5	70	BHNBR B4B210	ES	24218655	-		○
	660	80	80	BHNBR B4B210	ES	24219093	-		○
	660	81,5	80	BHNBR B4B210	ES	24087689	-		○
	670	100	100	BHNBR B4B210	ES	24219095	-		○
	670	102	100	BHNBR B4B210	ES	24218657	-		○
	670	200	200	BHNBR B6B210	V 1000	24084988	-		○
	670	200	200	BHNR B6A151	V 1000	24142736	-		○
	630	654	7,6	8,1	PTFE B602/NBR	OMS-MR	24268690	IP	
654		7,6	8,1	PTFE B602/FKM	OMS-MR	24344768	-		○
654		7,6	8,1	PTFE GM201/NBR	OMS-MR	24268692	-		○
654		7,6	8,1	PTFE C104/NBR	OMS-MR PR	49023709	-		○
665		16,4	17,5	PTFE GM201	OMS-S	24356724	-		○
665		16,4	17,5	PTFE GM201	OMS-S PR	49017444	-		○
670		29,1	32	93 AU V168	TM 20	24359778	-		○
670		61,5	60	BHNBR B4B210	ES	24064701	-		○
670		61,5	60	BHNBR B4B210	ES	24106809	-		○
670		70	70	BHNBR B4B210	ES	24084675	-		○
670		70	70	BHNBR B4B210	ES	24219238	-		○

d [mm]	D [mm]	H [mm]	L [mm]	Material	Design	Part No.	PU ¹⁾	US	EU
	670	71,5	70	BHNBR B4B210	ES	24218658	-		○
	670	71,5	70	BHNBR B4B210	ES	24218835	-		○
	670	80	80	BHNBR B4B210	ES	24219096	-		○
	670	80	80	BHNBR B4B210	ES	24219239	-		○
	670	81,5	80	BHNBR B4B210	ES	24218659	-		○
	670	81,5	80	BHNBR B4B210	ES	24218836	-		○
630	680	100	100	BHNBR B4B210	ES	24219098	-		○
	680	102	100	BHNBR B4B210	ES	24218661	-		○
	680	187,6	187,6	BHNBR B6B210	V 1000	24069554	-		○
	680	200	200	BHNBR B6B210	V 1000	24099618	-		○
	680	200	200	BHNBR B6B210	V 1000	24220925	-		○
	680	200	200	BHNBR B6B210	V 1000	24328608	-		○
	682	198	198	BHNBR B6B210	V 1000	49002502	-		○
635	659	7,6	8,1	PTFE B602/NBR	OMS-MR	24376193	-		○
	673,1	127	127	BHNBR B6A151	V 1000	24111999	-		○
	660	14,6	16	93 AU V168	TM 20	24358387	-		○
	664	7,6	8,1	PTFE B602/NBR	OMS-MR	24275726	IP		●
	664	7,6	8,1	PTFE B602/FKM	OMS-MR	24344769	-		○
	664	7,6	8,1	PTFE GM201/NBR	OMS-MR	24275878	-		○
	665	18,2	20	94 AU 925	TM 20	49066483	-		○
	675	16,4	17,5	PTFE GM201	OMS-S	24226250	-		○
	675	16,4	17,5	PTFE C104	OMS-S PR	49046152	-		○
640	680	70	70	BHNBR B4B210	ES	24219099	-		○
	680	71,5	70	BHNBR B4B210	ES	24218662	-		○
	680	80	80	BHNBR B4B210	ES	24087777	-		○
	680	81,5	80	BHNBR B4B210	ES	24218663	-		○
	690	100	100	BHNBR B4B210	ES	24219101	-		○
	690	102	100	BHNBR B4B210	ES	24148978	-		○
	690	195	195	BHNBR B6B210	V 1000	24240577	-		○
	690	200	200	BHNBR B6B210	V 1000	24112670	-		○
	690	200	200	BHNBR B6B210	V 1000	24126349	-		○
	690	230	230	BHNBR B6B210	V 1000	24077702	-		○
646	701	192	192	BHNBR B6B210	V 1000	24264281	-		○
	677,3	8,7	9,5	PTFE B602/NBR	OMS-MR	24275734	IP		●
	677,3	8,7	9,5	PTFE B602/FKM	OMS-MR	24344770	-		○
	677,3	8,7	9,5	PTFE GM201/NBR	OMS-MR	24275866	-		○
	677,3	8,7	9,5	PTFE B602/NBR	OMS-MR PR	49038772	-		○
	685	16,4	17,5	PTFE GM201	OMS-S	24224750	IP		●
	690	70	70	BHNBR B4B210	ES	24219102	-		○
	690	70	70	BHNBR B4B210	ES	24219240	-		○
	690	71,5	70	BHNBR B4B210	ES	24074106	-		○
650	690	71,5	70	BHNBR B4B210	ES	24218839	-		○
	690	80	80	BHNBR B4B210	ES	24081546	-		○
	690	80	80	BHNBR B4B210	ES	24172074	-		○
	690	81,5	80	BHNBR B4B210	ES	24116502	-		○
	690	81,5	80	BHNBR B4B210	ES	24218840	-		○
	690	126	126	BHNBR B6B210	V 1000	24293784	-		○
	690	158	158	BHNBR B6A151	V 1000	24127989	-		○
	690	190	190	BHNBR B6B210	V 1000	24341706	-		○
	700	100	100	BHNBR B4B210	ES	24267972	-		○

d [mm]	D [mm]	H [mm]	L [mm]	Material	Design	Part No.	PU ¹⁾	US	EU
650	700	150	150	BHNBR B6B210	V 1000	24349319	-		○
	700	200	200	BHNR B6A151	V 1000	24328457	-		○
654,1	704,9	203	203	BHNBR B6B210	V 1000	24145955	-		○
655	690	16,4	17,5	PTFE GM201	OMS-S	24374060	-		○
660	685	18,2	20	94 AU 925	TM 20	49064940	-		○
	687,3	8,7	9,5	PTFE B602 / NBR	OMS-MR	24275704	-		○
	687,3	8,7	9,5	PTFE B602 / FKM	OMS-MR	24344771	-		○
	687,3	8,7	9,5	PTFE C104 / FKM	OMS-MR	49030808	-		○
	687,3	8,7	9,5	PTFE GM201 / NBR	OMS-MR	24275889	-		○
	695	16,4	17,5	PTFE GM201	OMS-S	24377265	-		○
	700	70	70	BHNBR B4B210	ES	24219103	-		○
	700	71,5	70	BHNBR B4B210	ES	24218665	-		○
	700	80	80	BHNBR B4B210	ES	24219104	-		○
	700	81,5	80	BHNBR B4B210	ES	24218666	-		○
	700	175,1	175,1	BHNBR B6B210	V 1000	24312114	-		○
	710	80	80	BHNBR B4B210	ES	24197590	-		○
	710	100	100	BHNBR B4B210	ES	24219106	-		○
	710	102	100	BHNBR B4B210	ES	24218668	-		○
	710	230	230	BHNR B6A151	V 1000	24103429	-		○
	712	198	198	BHNBR B6B210	V 1000	24073266	-		○
	670	695	18,2	20	93 AU V168	TM 20	24359552	-	
697,3		8,7	9,5	PTFE B602 / NBR	OMS-MR	24275713	-		○
697,3		8,7	9,5	PTFE B602 / FKM	OMS-MR	24344772	-		○
697,3		8,7	9,5	PTFE GM201 / NBR	OMS-MR	24275896	-		○
697,3		8,7	9,5	PTFE C104 / NBR	OMS-MR PR	49017644	-		○
705		16,4	17,5	PTFE B602	OMS-S	24367550	-		○
705		16,4	17,5	PTFE GM201	OMS-S	24224741	-		○
710		24,9	26	93 AU V168	TMP 20	24368259	-		○
710		25	26,5	80 NBR B246	Seal Set 0216	24293600	-		○
710		29,1	32	93 AU V168	TM 20	24359779	-		○
710		81,5	80	BHNBR B4B210	ES	24071181	-		○
714		199,9	199,9	BHNBR B6B210	V 1000	24175477	-		○
720		100	100	BHNBR B4B210	ES	24176117	-		○
720		100	100	BHNBR B4B210	ES	24219108	-		○
720		102	100	BHNBR B4B210	ES	24218670	-		○
720		102	100	BHNBR B4B210	ES	24218842	-		○
720		142	142	BHNBR B6B210	V 1000	24346269	-		○
720	200	200	BHNBR B6B210	V 1000	24081923	-		○	
673,1	700,4	8,7	9,5	PTFE B602 / NBR	OMS-MR	24370576	-		○
675	725	100	100	BHNBR B4B210	ES	24103976	-		○
	725	230	230	BHNBR B6B210	V 1000	24295867	-		○
680	705	18,2	20	94 AU 925	TM 20	49066484	-		○
	707,3	8,7	9,5	PTFE B602 / NBR	OMS-MR	24269482	-		○
	707,3	8,7	9,5	PTFE B602 / FKM	OMS-MR	24344773	-		○
	707,3	8,7	9,5	PTFE GM201 / NBR	OMS-MR	24275906	-		○
	710	60	60	BHNBR B4B210	ES	24348073	-		○
	715	16,4	17,5	PTFE GM201	OMS-S	24238543	-		○
	715	16,4	17,5	PTFE GM201	OMS-S PR	49026183	-		○
	720	70	70	BHNBR B4B210	ES	24219109	-		○
720	71,5	70	BHNBR B4B210	ES	24218671	-		○	

d [mm]	D [mm]	H [mm]	L [mm]	Material	Design	Part No.	PU ¹⁾	US	EU
680	720	80	80	BHNBR B4B210	ES	24219110	-		○
	720	81,5	80	BHNBR B4B210	ES	24218673	-		○
	720	143	143	BHNBR B6B210	V 1000	24130360	-		○
	730	100	100	BHNBR B4B210	ES	24219112	-		○
	730	102	100	BHNBR B4B210	ES	24218672	-		○
	730	195	195	BHNBR B6B210	V 1000	24079296	-		○
	730	195	195	BHNBR B6B210	V 1000	24233952	-		○
685	725	81,5	80	BHNBR B4B210	ES	24192820	-		○
690	717,3	8,7	9,5	PTFE B602 /NBR	OMS-MR	24275725	-		○
	717,3	8,7	9,5	PTFE B602 /FKM	OMS-MR	24344774	-		○
	717,3	8,7	9,5	PTFE GM201 /NBR	OMS-MR	24275877	-		○
	725	16,4	17,5	PTFE B602	OMS-S	24347090	-		○
	725	16,4	17,5	PTFE GM201	OMS-S	528031	-		○
	730	61,5	60	BHNBR B4B210	ES	24293797	-		○
	730	70	70	BHNBR B4B210	ES	24219113	-		○
	730	70	70	BHNBR B4B210	ES	24219242	-		○
	730	71,5	70	BHNBR B4B210	ES	24218674	-		○
	730	71,5	70	BHNBR B4B210	ES	24218843	-		○
	730	80	80	BHNBR B4B210	ES	24219114	-		○
	730	80	80	BHNBR B4B210	ES	24219243	-		○
	730	81,5	80	BHNBR B4B210	ES	24109229	-		○
	730	81,5	80	BHNBR B4B210	ES	24218844	-		○
	740	176	176	BHNBR B6B210	V 1000	24363225	-		○
695	735	80	80	BHNBR B4B210	ES	24296289	-		○
699	734	16,4	17,5	PTFE GM201	OMS-S	24330038	-		○
700	725	18,2	20	94 AU 925	TM 20	49066485	-		○
	727,3	8,7	9,5	PTFE B602 /NBR	OMS-MR	24275741	-		○
	727,3	8,7	9,5	PTFE B602 /FKM	OMS-MR	24344775	-		○
	727,3	8,7	9,5	PTFE GM201 /NBR	OMS-MR	24275865	-		○
	730	60	60	BHNBR B4B210	ES	24120063	-		○
	740	18,7	20	PTFE B602	OMS-S	24338738	-		○
	740	18,7	20	PTFE GM201	OMS-S	24191357	-		○
	740	60	60	BHNBR B4B210	ES	24106925	-		○
	740	61,5	60	BHNBR B4B210	ES	24193914	-		○
	740	70	70	BHNBR B4B210	ES	24078869	-		○
	740	70	70	BHNBR B4B210	ES	24219115	-		○
	740	71,5	70	BHNBR B4B210	ES	24103215	-		○
	740	71,5	70	BHNBR B4B210	ES	24218845	-		○
	740	80	80	BHNBR B4B210	ES	24219116	-		○
	740	80	80	BHNBR B4B210	ES	24219261	-		○
	740	81,5	80	BHNBR B4B210	ES	24218675	-		○
	740	81,5	80	BHNBR B4B210	ES	24218846	-		○
	740	90,5	89	BHNBR B4B210	ES	24239435	-		○
	740	126	126	BHNBR B6B210	V 1000	24192973	-		○
	750	100	100	BHNBR B4B210	ES	24219118	-		○
	750	102	100	BHNBR B4B210	ES	24128272	-		○
	750	195	195	BHNR B6A151	V 1000	24344128	-		○
	754	160	160	BHNBR B6B210	V 1000	24354734	-		○
760	190	190	BHNBR B6B210	V 1000	528695	-		○	
705,6	749,6	184,1	184,1	BHNR B6A151	V 1000	24268172	-		○

d [mm]	D [mm]	H [mm]	L [mm]	Material	Design	Part No.	PU ¹⁾	US	EU	
706	760	230	230	BHNBR B6B210	V 1000	528900	-		○	
708	758	177	177	BHNR B6A151	V 1000	533685	-		○	
709,5	759,5	200	200	BHNBR B6B210	V 1000	24250895	-		○	
710	737,3	8,7	9,5	PTFE B602 / NBR	OMS-MR	24275705	-		○	
	737,3	8,7	9,5	PTFE B602 / FKM	OMS-MR	24344776	-		○	
	737,3	8,7	9,5	PTFE GM201 / NBR	OMS-MR	24275888	-		○	
	750	18,7	20	PTFE GM201	OMS-S PR	49017446	-		○	
	750	29,1	32	93 AU V168	TM 20	24359780	-		○	
	750	60	60	BHNBR B4B210	ES	24195814	-		○	
	750	61,5	60	BHNBR B4B210	ES	24238814	-		○	
	750	70	70	BHNBR B4B210	ES	24074993	-		○	
	750	70	70	BHNBR B4B210	ES	24219121	-		○	
	750	71,5	70	BHNBR B4B210	ES	24082443	-		○	
	750	71,5	70	BHNBR B4B210	ES	24218679	-		○	
	750	80	80	BHNBR B4B210	ES	24219122	-		○	
	750	80	80	BHNBR B4B210	ES	24219245	-		○	
	750	81,5	80	BHNBR B4B210	ES	24071177	-		○	
	750	81,5	80	BHNBR B4B210	ES	24218849	-		○	
	750	90,5	89	BHNBR B4B210	ES	24129422	-		○	
	750	143	143	BHNBR B6B210	V 1000	24363082	-		○	
	750	170	170	BHNBR B6B210	V 1000	24370546	-		○	
	760	100	100	BHNBR B4B210	ES	24114586	-		○	
	760	100	100	BHNBR B4B210	ES	24186413	-		○	
	760	102	100	BHNBR B4B210	ES	24218680	-		○	
	760	102	100	BHNBR B4B210	ES	24218851	-		○	
	760	129	129	BHNBR B6B210	V 1000	24358000	-		○	
	760	190	190	BHNBR B6B210	V 1000	24099757	-		○	
	760	230	230	BHNBR B6B210	V 1000	24227204	-		○	
	760	230	230	BHNR B6A151	V 1000	24373181	-		○	
	711,2	749,3	154,9	154,9	BHNBR B6B210	V 1000	24144242	-		○
		751,2	155,4	155,4	BHNBR B6B210	V 1000	24350752	-		○
751,2		175	175	BHNBR B6B210	V 1000	24078717	-		○	
762		224	224	BHNBR B6B210	V 1000	24289652	-		○	
718	758	158	158	BHNR B6A151	V 1000	24300575	-		○	
719	769	177	177	BHNR B6A151	V 1000	24295158	-		○	
720	745	18,2	20	93 AU V168	TM 20	49004523	-		○	
	745	18,2	20	94 AU 925	TM 20	49054686	-		○	
	747,3	8,7	9,5	PTFE B602 / NBR	OMS-MR	24275712	-		○	
	747,3	8,7	9,5	PTFE B602 / FKM	OMS-MR	24344777	-		○	
	747,3	8,7	9,5	PTFE GM201 / NBR	OMS-MR	24275895	-		○	
	747,3	8,7	9,5	PTFE GM201 / NBR	OMS-MR PR	49054628	IP		●	
	760	18,7	20	PTFE GM201	OMS-S	24224754	-		○	
	760	18,7	20	PTFE GM201	OMS-S PR	49004522	-		○	
	760	29,1	32	93 AU V168	TM 20	24359781	-		○	
	760	30	32	80 NBR B246	Seal Set 0216	24361403	-		○	
	760	70	70	BHNBR B4B210	ES	24219123	-		○	
	760	71,5	70	BHNBR B4B210	ES	24218681	-		○	
	760	80	80	BHNBR B4B210	ES	24187283	-		○	
	760	143	143	BHNBR B6B210	V 1000	24290043	-		○	
	760	158	158	BHNBR B6B210	V 1000	24306127	-		○	

d [mm]	D [mm]	H [mm]	L [mm]	Material	Design	Part No.	PU ¹⁾	US	EU	
720	770	36,4	40	93 AU V168	TM 20	24357182	-		○	
	770	100	100	BHNBR B4B210	ES	24219125	-		○	
	770	100	100	BHNBR B4B210	ES	24219247	-		○	
	770	102	100	BHNBR B4B210	ES	24218684	-		○	
	770	102	100	BHNBR B4B210	ES	24218853	-		○	
	770	190	190	BHNBR B6B210	V 1000	24239607	-		○	
	770	200	200	BHNBR B6B210	V 1000	24356307	-		○	
	780	205	205	BHNBR B6B210	V 1000	24334188	-		○	
725	775	200	200	BHNBR B6B210	V 1000	24328468	-		○	
730	757,3	8,7	9,5	PTFE B602 / NBR	OMS-MR	24275724	-		○	
	757,3	8,7	9,5	PTFE B602 / FKM	OMS-MR	24344778	-		○	
	757,3	8,7	9,5	PTFE GM201 / NBR	OMS-MR	24275905	-		○	
	757,3	8,7	9,5	PTFE GM201 / FKM	OMS-MR	49003746	-		○	
	757,3	8,7	9,5	PTFE C104 / NBR	OMS-MR PR	49018768	-		○	
	770	18,7	20	PTFE GM201	OMS-S	24263626	-		○	
	770	18,7	20	PTFE GM201	OMS-S PR	49015650	-		○	
	780	129	129	BHNR B6A151	V 1000	24219420	-		○	
	780	160	160	BHNBR B6B210	V 1000	24341821	-		○	
	780	161	161	BHNBR B6B210	V 1000	24072739	-		○	
	780	161	161	BHNR B6A151	V 1000	24209213	-		○	
	780	230	230	BHNR B6A151	V 1000	24258590	-		○	
730,5	794	190,5	190,5	BHNR B6A151	V 1000	524598	-		○	
735	762,3	8,7	9,5	PTFE B602 / NBR	OMS-MR	24350580	-		○	
736,6	787,4	200	200	BHNBR B6B210	V 1000	533195	-		○	
	787,4	230	230	BHNR B6A151	V 1000	24109290	-		○	
740	765	18,2	20	94 AU 925	TM 20	49066486	-		○	
	767,3	8,7	9,5	PTFE B602 / NBR	OMS-MR	24275749	-		○	
	767,3	8,7	9,5	PTFE B602 / FKM	OMS-MR	24344779	-		○	
	767,3	8,7	9,5	PTFE GM201 / NBR	OMS-MR	24275876	-		○	
	780	18,7	20	PTFE GM201	OMS-S	24224763	-		○	
	780	60	60	BHNBR B4B210	ES	24249215	-		○	
	780	70	70	BHNBR B4B210	ES	24219126	-		○	
	780	71,5	70	BHNBR B4B210	ES	24083448	-		○	
	780	80	80	BHNBR B4B210	ES	24219127	-		○	
	780	81,5	80	BHNBR B4B210	ES	24218685	-		○	
	780	143	143	BHNBR B6B210	V 1000	24290757	-		○	
	790	100	100	BHNBR B4B210	ES	24219129	-		○	
	790	102	100	BHNBR B4B210	ES	24218687	-		○	
	790	190	190	BHNBR B6B210	V 1000	24190601	-		○	
	790	230	230	BHNBR B6B210	V 1000	24145292	-		○	
	750	777,3	8,7	9,5	PTFE B602 / NBR	OMS-MR	24275736	IP		●
		777,3	8,7	9,5	PTFE B602 / FKM	OMS-MR	24344780	-		○
		777,3	8,7	9,5	PTFE GM201 / NBR	OMS-MR	24275864	-		○
777,3		8,7	9,5	PTFE B602 / NBR	OMS-MR PR	49020530	-		○	
777,3		8,7	9,5	PTFE C104 / NBR	OMS-MR PR	49017645	-		○	
790		18,7	20	PTFE GM201	OMS-S	24236499	-		○	
790		60	60	BHNBR B4B210	ES	24095999	-		○	
790		61,5	60	BHNBR B4B210	ES	24180151	-		○	
790		70	70	BHNBR B4B210	ES	24219130	-		○	
790		70	70	BHNBR B4B210	ES	24219248	-		○	

d [mm]	D [mm]	H [mm]	L [mm]	Material	Design	Part No.	PU ¹⁾	US	EU
750	790	71,5	70	BHNBR B4B210	ES	24132429	-		○
	790	71,5	70	BHNBR B4B210	ES	24218688	-		○
	790	80	80	BHNBR B4B210	ES	24219131	-		○
	790	80	80	BHNBR B4B210	ES	24219249	-		○
	790	81,5	80	BHNBR B4B210	ES	24213562	-		○
	790	81,5	80	BHNBR B4B210	ES	24218689	-		○
	790	143	143	BHNBR B6B210	V 1000	24351539	-		○
	790	143	143	BHNR B6A151	V 1000	24138734	-		○
	790	190	190	BHNBR B6B210	V 1000	24332683	-		○
	800	32	34	93 AU V168	TMP 20	24368261	-		○
	800	36,4	40	93 AU V168	TM 20	24359782	-		○
	800	100	100	BHNBR B4B210	ES	24193397	-		○
	800	100	100	BHNBR B4B210	ES	24193398	-		○
	800	102	100	BHNBR B4B210	ES	24140930	-		○
	800	102	100	BHNBR B4B210	ES	24218854	-		○
	800	200	200	BHNBR B6B210	V 1000	24075462	-		○
755	795	18,7	20	PTFE GM201	OMS-S	24377266	-		○
760	785	18,2	20	94 AU 925	TM 20	24380543	-		○
	787,3	8,7	9,5	PTFE B602/NBR	OMS-MR	24275706	-		○
	787,3	8,7	9,5	PTFE B602/FKM	OMS-MR	24344781	-		○
	787,3	8,7	9,5	PTFE GM201/NBR	OMS-MR	24275887	-		○
	787,3	8,7	9,5	PTFE B602/NBR	OMS-MR PR	49039345	-		○
	800	18,7	20	PTFE GM201	OMS-S	24224765	-		○
	800	80	80	BHNBR B4B210	ES	24235532	-		○
	810	89	87	BHNBR B4B210	ES	24259129	-		○
	810	190	190	BHNBR B6B210	V 1000	24377920	-		○
	810	190	190	BHNR B6A151	V 1000	49004692	-		○
767	810	230	230	BHNBR B6B210	V 1000	529609	-		○
	810	230	230	BHNR B6A151	V 1000	49005116	-		○
768	794,3	8,7	9,5	PTFE B602/NBR	OMS-MR	24357892	-		○
770	822	212,7	212,7	BHNBR B6B210	V 1000	24355003	-		○
	797,3	8,7	9,5	PTFE B602/NBR	OMS-MR	24275723	-		○
	797,3	8,7	9,5	PTFE B602/FKM	OMS-MR	24344782	-		○
	797,3	8,7	9,5	PTFE C104/NBR	OMS-MR	49055696	-		○
	797,3	8,7	9,5	PTFE GM201/NBR	OMS-MR	24275894	-		○
	797,3	8,7	9,5	PTFE C104/NBR	OMS-MR PR	49055742	-		○
	810	18,7	20	PTFE B602	OMS-S	24343738	-		○
	810	18,7	20	PTFE GM201	OMS-S	24357244	-		○
	820	166	166	BHNBR B6B210	V 1000	24362210	-		○
	820	185	185	BHNBR B6B210	V 1000	24375371	-		○
772	820	200	200	BHNR B6A151	V 1000	24256829	-		○
	830	230	230	BHNBR B6B210	V 1000	24353514	-		○
775	822	230	230	BHNR B6A151	V 1000	24146266	-		○
780	825	71,5	70	BHNBR B4B210	ES	24343719	-		○
	805	18,2	20	94 AU 925	TM 20	49032355	-		○
	807,3	8,7	9,5	PTFE B602/NBR	OMS-MR	24275711	-		○
	807,3	8,7	9,5	PTFE B602/FKM	OMS-MR	24344783	-		○
	807,3	8,7	9,5	PTFE GM201/NBR	OMS-MR	24275904	-		○
	820	18,7	20	PTFE GM201	OMS-S PR	49032356	-		○
820	60	60	BHNBR B4B210	ES	24256704	-		○	

d [mm]	D [mm]	H [mm]	L [mm]	Material	Design	Part No.	PU ¹⁾	US	EU
780	820	61,5	60	BHNBR B4B210	ES	24291255	-		○
	830	100	100	BHNBR B4B210	ES	24239957	-		○
	830	102	100	BHNBR B4B210	ES	24134874	-		○
	830	166	166	BHNR B6A151	V 1000	24369144	-		○
	830	190	190	BHNBR B6B210	V 1000	24226117	-		○
	830	200	200	BHNBR B6B210	V 1000	24148684	-		○
	830	230	230	BHNBR B6B210	V 1000	24342184	-		○
787,4	814,7	8,7	9,5	PTFE B602 / NBR	OMS-MR	24331506	-		○
790	817,3	8,7	9,5	PTFE B602 / NBR	OMS-MR	24275748	-		○
	817,3	8,7	9,5	PTFE B602 / FKM	OMS-MR	24344784	-		○
	817,3	8,7	9,5	PTFE GM201 / NBR	OMS-MR	24275875	-		○
	830	18,7	20	PTFE C104	OMS-S	49026600	-		○
	830	18,7	20	PTFE GM201	OMS-S	49015688	-		○
	830	18,7	20	PTFE GM201	OMS-S PR	49015649	-		○
	830	190	190	BHNBR B6B210	V 1000	24302398	-		○
	840	100	100	BHNBR B4B210	ES	24308317	-		○
	850	180	180	BHNR B6A151	V 1000	24342143	-		○
	850	220	220	BHNR B6A151	V 1000	532413	-		○
	793	853	190	190	BHNR B6A151	V 1000	24311359	-	
795	822,3	8,7	9,5	PTFE B602 / NBR	OMS-MR	24344330	-		○
	850	170	170	BHNBR B6B210	V 1000	24264467	-		○
797	852	202	202	BHNR B6A151	V 1000	24199549	-		○
799	853	230	230	BHNR B6A151	V 1000	528941	-		○
800	825	18,2	20	93 AU V168	TM 20	24359783	-		○
	825	18,2	20	94 AU 925	TM 20	49028614	-		○
	827,3	8,7	9,5	PTFE B602 / NBR	OMS-MR	24275737	-		○
	827,3	8,7	9,5	PTFE B602 / FKM	OMS-MR	24344785	-		○
	827,3	8,7	9,5	PTFE GM201 / NBR	OMS-MR	24275863	-		○
	827,3	8,7	9,5	PTFE B602 / NBR	OMS-MR PR	49003492	-		○
	840	18,7	20	PTFE B602	OMS-S	24380122	-		○
	840	18,7	20	PTFE GM201	OMS-S	24224758	-		○
	840	18,7	20	PTFE GM201	OMS-S PR	49015797	-		○
	840	60	60	BHNBR B4B210	ES	24188792	-		○
	840	60	60	BHNBR B4B210	ES	24339222	-		○
	840	70	70	BHNBR B4B210	ES	24259099	-		○
	840	71,5	70	BHNBR B4B210	ES	24218691	-		○
	840	80	80	BHNBR B4B210	ES	24219134	-		○
	840	80	80	BHNBR B4B210	ES	24259100	-		○
	840	81,5	80	BHNBR B4B210	ES	24071169	-		○
	840	143	143	BHNBR B6B210	V 1000	24377819	-		○
	840	170	170	BHNBR B6B210	V 1000	24227463	-		○
	850	32	34	80 NBR B246	Seal Set 0214	24300506	-		○
	850	32	34	80 NBR B246	Seal Set 0216	24361423	-		○
	850	32	34	93 AU V168	TMP 20	24368262	-		○
	850	70	70	BHNBR B4B210	ES	24192354	-		○
	850	80	80	BHNBR B4B210	ES	24067763	-		○
	850	82	80	BHNBR B4B210	ES	24077894	-		○
	850	100	100	BHNBR B4B210	ES	24066922	-		○
	850	100	100	BHNBR B4B210	ES	24094794	-		○
	850	102	100	BHNBR B4B210	ES	24103851	-		○

d [mm]	D [mm]	H [mm]	L [mm]	Material	Design	Part No.	PU ¹⁾	US	EU
	850	102	100	BHNBR B4B210	ES	24104080	-		○
	850	150	150	BHNR B6A151	V 1000	24378368	-		○
	850	166	166	BHNBR B6B210	V 1000	24343112	-		○
	850	185	185	BHNR B6A151	V 1000	24348887	-		○
	850	190	190	BHNBR B6B210	V 1000	24141357	-		○
800	850	190	190	BHNR B6A151	V 1000	24259890	-		○
	850	200	200	BHNBR B6B210	V 1000	24097696	-		○
	850	200	200	BHNR B6A151	V 1000	24095200	-		○
	850	230	230	BHNBR B6B210	V 1000	24194356	-		○
	850	235	235	BHNBR B6B210	V 1000	24243659	-		○
	860	190	190	BHNBR B6B210	V 1000	24288741	-		○
800,1	850,9	190	190	BHNBR B6B210	V 1000	24175548	-		○
809	866,2	209,5	209,5	BHNBR B6B210	V 1000	24358439	-		○
	837,3	8,7	9,5	PTFE B602 / NBR	OMS-MR	24275707	-		○
	837,3	8,7	9,5	PTFE B602 / FKM	OMS-MR	24344786	-		○
	837,3	8,7	9,5	PTFE GM201 / NBR	OMS-MR	24275886	-		○
810	850	18,7	20	PTFE GM201	OMS-S	24370506	-		○
	850	81,5	80	BHNBR B4B210	ES	24353087	-		○
	860	160	160	BHNBR B6B210	V 1000	24237993	-		○
	870	205	205	BHNBR B6B210	V 1000	24350234	-		○
	857,8	164	164	BHNBR B6B210	V 1000	24183225	-		○
812,8	863,6	208	208	BHNBR B6B210	V 1000	24134805	-		○
	863,6	240	240	BHNBR B6B210	V 1000	24179576	-		○
815	865	200	200	BHNBR B6B210	V 1000	24230733	-		○
	845	18,2	20	94 AU 925	TM 20	49066487	-		○
	847,3	8,7	9,5	PTFE B602 / NBR	OMS-MR	24275722	-		○
	847,3	8,7	9,5	PTFE B602 / FKM	OMS-MR	24344787	-		○
	847,3	8,7	9,5	PTFE GM201 / NBR	OMS-MR	24275893	-		○
	860	18,7	20	PTFE GM201	OMS-S	24224762	-		○
	860	71,5	70	BHNBR B4B210	ES	24263168	-		○
	870	36,4	40	93 AU V168	TM 20	24357250	-		○
820	870	100	100	BHNBR B4B210	ES	24114587	-		○
	870	100	100	BHNBR B4B210	ES	24219137	-		○
	870	102	100	BHNBR B4B210	ES	24218694	-		○
	870	102	100	BHNBR B4B210	ES	24218857	-		○
	870	185	185	BHNBR B6B210	V 1000	24333901	-		○
	870	195	195	BHNBR B6B210	V 1000	24214211	-		○
	870	200	200	BHNBR B6B210	V 1000	24350822	-		○
	880	230	230	BHNBR B6B210	V 1000	24234377	-		○
824	878	198	198	BHNR B6A151	V 1000	24371128	-		○
	875	102	100	BHNBR B4B210	ES	24267024	-		○
825	875	150	150	BHNBR B6B210	V 1000	531138	-		○
	875	200	200	BHNBR B6B210	V 1000	24291827	-		○
	855	18,2	20	93 AU V168	TM 20	49003544	-		○
	857,3	8,7	9,5	PTFE B602 / NBR	OMS-MR	24275747	-		○
	857,3	8,7	9,5	PTFE B602 / FKM	OMS-MR	24344788	-		○
830	857,3	8,7	9,5	PTFE GM201 / NBR	OMS-MR	24275903	-		○
	870	18,7	20	PTFE GM201	OMS-S	24344383	-		○
	870	18,7	20	PTFE GM201	OMS-S PR	49003543	-		○
	880	100	100	BHNBR B4B210	ES	24342533	-		○

d [mm]	D [mm]	H [mm]	L [mm]	Material	Design	Part No.	PU ¹⁾	US	EU	
830	880	190	190	BHNBR B6A151	V 1000	24344986	-		○	
	880	200	200	BHNBR B6B210	V 1000	24261254	-		○	
	880	200	200	BHNBR B6A151	V 1000	24095640	-		○	
	890	190	190	BHNBR B6B210	V 1000	24359689	-		○	
840	865	18,2	20	94 AU 925	TM 20	49066488	-		○	
	867,3	8,7	9,5	PTFE B602 / NBR	OMS-MR	24275752	-		○	
	867,3	8,7	9,5	PTFE B602 / FKM	OMS-MR	24344789	-		○	
	867,3	8,7	9,5	PTFE GM201 / NBR	OMS-MR	24275874	-		○	
	880	81,5	80	BHNBR B4B210	ES	24335687	-		○	
	890	100	100	BHNBR B4B210	ES	24357980	-		○	
	890	235	235	BHNBR B6B210	V 1000	24084158	-		○	
	894	150	150	BHNBR B6A151	V 1000	527151	-		○	
850	877,3	8,7	9,5	PTFE B602 / NBR	OMS-MR	24275738	-		○	
	877,3	8,7	9,5	PTFE B602 / FKM	OMS-MR	24344790	-		○	
	877,3	8,7	9,5	PTFE GM201 / NBR	OMS-MR	24275862	-		○	
	880	123,4	123,4	BHNBR B5B210	V 1000	24148882	-		○	
	890	18,7	20	PTFE GM201	OMS-S	24215728	-		○	
	890	30	32	80 NBR B246	Seal Set O214	24311337	-		○	
	890	30	32	80 NBR B246	Seal Set O216	24311336	-		○	
	890	60	60	BHNBR B4B210	ES	24339224	-		○	
	890	61,5	60	BHNBR B4B210	ES	24263169	-		○	
	890	70	70	BHNBR B4B210	ES	24114461	-		○	
	890	70	70	BHNBR B4B210	ES	24219138	-		○	
	890	71,5	70	BHNBR B4B210	ES	24218695	-		○	
	890	71,5	70	BHNBR B4B210	ES	24218858	-		○	
	890	80	80	BHNBR B4B210	ES	24131119	-		○	
	890	80	80	BHNBR B4B210	ES	24219250	-		○	
	890	81,5	80	BHNBR B4B210	ES	24077013	-		○	
	890	81,5	80	BHNBR B4B210	ES	24218696	-		○	
	900	70	70	BHNBR B4B210	ES	24114382	-		○	
	900	100	100	BHNBR B4B210	ES	24219140	-		○	
	900	100	100	BHNBR B4B210	ES	24219252	-		○	
	900	102	100	BHNBR B4B210	ES	24218698	-		○	
	900	102	100	BHNBR B4B210	ES	24218860	-		○	
	900	190	190	BHNBR B6B210	V 1000	24230005	-		○	
	900	195	195	BHNBR B6B210	V 1000	24094778	-		○	
	900	200	200	BHNBR B6B210	V 1000	24097188	-		○	
	900	230	230	BHNBR B6B210	V 1000	24079681	-		○	
	854	904	240	240	BHNBR B6B210	V 1000	24251339	-		○
	860	885	18,2	20	94 AU 925	TM 20	49066489	-		○
		887,3	8,7	9,5	PTFE B602 / NBR	OMS-MR	24275708	-		○
		887,3	8,7	9,5	PTFE B602 / FKM	OMS-MR	24344791	-		○
		887,3	8,7	9,5	PTFE GM201 / NBR	OMS-MR	24275902	-		○
		900	18,7	20	PTFE GM201	OMS-S	24224755	-		○
900		60	60	BHNBR B4B210	ES	24359911	-		○	
910		102	100	BHNBR B4B210	ES	24199041	-		○	
910		195	195	BHNBR B6B210	V 1000	24339538	-		○	
910		200	200	BHNBR B6B210	V 1000	24378230	-		○	
910		200	200	BHNBR B6A151	V 1000	24100649	-		○	
910	240	240	BHNBR B6B210	V 1000	24217402	-		○		

d [mm]	D [mm]	H [mm]	L [mm]	Material	Design	Part No.	PU ¹⁾	US	EU
863,6	914,4	134	134	BHNBR B6B210	V 1000	24332067	-		○
	914,4	166	166	BHNBR B6B210	V 1000	24241027	-		○
870	897,3	8,7	9,5	PTFE B602 / NBR	OMS-MR	24275721	-		○
	897,3	8,7	9,5	PTFE B602 / FKM	OMS-MR	24344792	-		○
	897,3	8,7	9,5	PTFE GM201 / NBR	OMS-MR	24275892	-		○
	908	12,9	13,8	PTFE C104 / NBR	OMS-MR PR	49018775	-		○
	920	100	100	BHNBR B4B210	ES	24219142	-		○
	920	100	100	BHNBR B4B210	ES	24219254	-		○
	920	102	100	BHNBR B4B210	ES	24117560	-		○
	920	102	100	BHNBR B4B210	ES	24218862	-		○
	920	160	160	BHNR B6A151	V 1000	24173923	-		○
	920	200	200	BHNR B6A151	V 1000	24360862	-		○
875	930	230	230	BHNBR B6B210	V 1000	24353733	-		○
	902,3	8,7	9,5	PTFE B602 / NBR	OMS-MR	528024	-		○
	925	100	100	BHNBR B4B210	ES	24101244	-		○
	925	102	100	BHNBR B4B210	ES	24085902	-		○
880	925	200	200	BHNBR B6B210	V 1000	24083901	-		○
	905	18,2	20	94 AU 925	TM 20	49062164	-		○
	907,3	8,7	9,5	PTFE B602 / NBR	OMS-MR	24275746	-		○
	907,3	8,7	9,5	PTFE B602 / FKM	OMS-MR	24344793	-		○
	907,3	8,7	9,5	PTFE GM201 / NBR	OMS-MR	24275885	-		○
	930	101	99	BHNBR B4B210	ES	24244245	-		○
889	930	195	195	BHNBR B6B210	V 1000	24240904	-		○
	939	240	240	BHNR B6A151	V 1000	24257727	-		○
890	943	230	230	BHNR B6A151	V 1000	24372317	-		○
	917,3	8,7	9,5	PTFE B602 / NBR	OMS-MR	24275753	IP		●
	917,3	8,7	9,5	PTFE B602 / FKM	OMS-MR	24344794	-		○
	917,3	8,7	9,5	PTFE GM201 / NBR	OMS-MR	24275873	-		○
	920	25	26	80 NBR B246	Seal Set 0216	24345895	-		○
	930	18,7	20	PTFE GM201	OMS-S	24264039	-		○
	940	190	190	BHNBR B6B210	V 1000	49002831	-		○
900	940	240	240	BHNR B6A151	V 1000	24288233	-		○
	945	200	200	BHNBR B6B210	V 1000	524754	-		○
	925	18,2	20	93 AU V168	TM 20	24359788	-		○
	925	18,2	20	94 AU 925	TM 20	49066490	-		○
	927,3	8,7	9,5	PTFE B602 / NBR	OMS-MR	24275739	-		○
	927,3	8,7	9,5	PTFE B602 / FKM	OMS-MR	24344795	-		○
	927,3	8,7	9,5	PTFE GM201 / NBR	OMS-MR	24275861	-		○
	927,3	8,7	9,5	PTFE B602 / NBR	OMS-MR PR	49032920	-		○
	940	18,7	20	PTFE B602	OMS-S	24348199	-		○
	940	18,7	20	PTFE GM201	OMS-S	24224764	-		○
	940	18,7	20	PTFE GM201	OMS-S PR	49006257	-		○
	940	70	70	BHNBR B4B210	ES	24219257	-		○
	940	71,5	70	BHNBR B4B210	ES	24218865	-		○
	940	80	80	BHNBR B4B210	ES	24219258	-		○
	940	81,5	80	BHNBR B4B210	ES	24218866	-		○
950	950	36,4	40	93 AU V168	TM 20	24359789	-		○
	950	100	100	BHNBR B4B210	ES	24066945	-		○
	950	100	100	BHNBR B4B210	ES	24219146	-		○
	950	102	100	BHNBR B4B210	ES	24218703	-		○

d [mm]	D [mm]	H [mm]	L [mm]	Material	Design	Part No.	PU ¹⁾	US	EU
900	950	102	100	BHNBR B4B210	ES	24218868	-		○
	950	166	166	BHNBR B6B210	V 1000	24343614	-		○
	950	190	190	BHNBR B6B210	V 1000	24220749	-		○
	950	195	195	BHNBR B6B210	V 1000	24096024	-		○
	950	200	200	BHNBR B6B210	V 1000	24145145	-		○
	950	200	200	BHNR B6A151	V 1000	24082187	-		○
	960	190	190	BHNR B6A151	V 1000	24370250	-		○
901,7	946,7	128	128	BHNBR B6B210	V 1000	24362372	-		○
910	937,3	8,7	9,5	PTFE B602 /NBR	OMS-MR	24275709	-		○
	937,3	8,7	9,5	PTFE B602 /FKM	OMS-MR	24344796	-		○
	937,3	8,7	9,5	PTFE GM201 /NBR	OMS-MR	24275901	-		○
	960	176	176	BHNR B6A151	V 1000	24234729	-		○
	960	185	185	BHNR B6A151	V 1000	24290872	-		○
	960	200	200	BHNR B6A151	V 1000	24260892	-		○
	970	190	190	BHNBR B6B210	V 1000	24258159	-		○
914,4	954,4	18,7	20	PTFE B602	OMS-S	24338739	-		○
	954,4	18,7	20	PTFE GM201	OMS-S	24236526	-		○
	965,2	230	230	BHNR B6A151	V 1000	24187112	-		○
920	945	18,2	20	94 AU 925	TM 20	24378523	-		○
	947,3	8,7	9,5	PTFE B602 /NBR	OMS-MR	24275720	-		○
	947,3	8,7	9,5	PTFE B602 /FKM	OMS-MR	24344797	-		○
	947,3	8,7	9,5	PTFE GM201 /NBR	OMS-MR	24275891	-		○
	960	18,7	20	PTFE GM201	OMS-S	49008662	-		○
	960	18,7	20	PTFE GM201	OMS-S PR	49011973	-		○
	965	200	200	BHNBR B6B210	V 1000	24133244	-		○
	970	147	147	BHNBR B6B210	V 1000	24263048	-		○
	970	190	190	BHNBR B6B210	V 1000	24195149	-		○
	970	192,5	192,5	BHNBR B6B210	V 1000	24078995	-		○
	970	200	200	BHNR B6A151	V 1000	24179853	-		○
	970	235	235	BHNBR B6B210	V 1000	24116351	-		○
	970	235	235	BHNR B6A151	V 1000	24067553	-		○
	970	240	240	BHNBR B6B210	V 1000	24147566	-		○
	980	100	100	BHNBR B6B210	V 1000	24267778	-		○
925	965	126	126	BHNBR B6B210	V 1000	24123320	-		○
	965	130,7	130,7	BHNR B5A151	V 1000	24100969	-		○
	975	100	100	BHNBR B4B210	ES	24351206	-		○
	975	150	150	BHNBR B6B210	V 1000	527802	-		○
	975	230	230	BHNR B6A151	V 1000	24068465	-		○
	980	170	170	BHNR B6A151	V 1000	24379667	-		○
930	957,3	8,7	9,5	PTFE B602 /NBR	OMS-MR	24275754	-		○
	957,3	8,7	9,5	PTFE B602 /FKM	OMS-MR	24344798	-		○
	957,3	8,7	9,5	PTFE GM201 /NBR	OMS-MR	24275884	-		○
	980	102	100	BHNBR B4B210	ES	24261784	-		○
	980	185	185	BHNR B6A151	V 1000	24342147	-		○
	980	195	195	BHNR B6A151	V 1000	24329098	-		○
	984	205,7	205,7	BHNBR B6B210	V 1000	24353065	-		○
935	975	18,7	20	PTFE B602	OMS-S	49002966	-		○
940	965	18,2	20	94 AU 925	TM 20	49022199	-		○
	967,3	8,7	9,5	PTFE B670 /NBR	OMS-MR	24275740	-		○
	967,3	8,7	9,5	PTFE B670 /FKM	OMS-MR	24344799	-		○

d [mm]	D [mm]	H [mm]	L [mm]	Material	Design	Part No.	PU ¹⁾	US	EU
940	967,3	8,7	9,5	PTFE GM201 / NBR	OMS-MR	24275872	-		○
	980	18,7	20	PTFE GM201	OMS-S PR	49022200	-		○
	990	190	190	BHNBR B6B210	V 1000	24343341	-		○
945	1000	170	170	BHNR B6A151	V 1000	24239676	-		○
950	975	18,2	20	93 AU V168	TM 20	24359554	-		○
	977,3	8,7	9,5	PTFE B670 / NBR	OMS-MR	24275710	-		○
	977,3	8,7	9,5	PTFE B670 / FKM	OMS-MR	24344800	-		○
	977,3	8,7	9,5	PTFE GM201 / NBR	OMS-MR	24275860	-		○
	990	18,7	20	PTFE B602	OMS-S	49011622	-		○
	990	18,7	20	PTFE GM201	OMS-S	24261553	-		○
	990	18,7	20	PTFE GM201	OMS-S	24262250	-		○
	1000	91	89	BHNBR B4B210	ES	24214711	-		○
	1000	100	100	BHNBR B4B210	ES	24114590	-		○
	1000	100	100	BHNBR B4B210	ES	24219150	-		○
	1000	102	100	BHNBR B4B210	ES	24218707	-		○
	1000	102	100	BHNBR B4B210	ES	24218870	-		○
	1000	190	190	BHNR B6A151	V 1000	24220704	-		○
	1000	195	195	BHNBR B6B210	V 1000	24262712	-		○
	1000	198	198	BHNBR B6B210	V 1000	24308212	-		○
	1000	200	200	BHNBR B6B210	V 1000	24089122	-		○
	1000	200	200	BHNR B6A151	V 1000	24076810	-		○
1000	230	230	BHNBR B6B210	V 1000	24188679	-		○	
1010	190	190	BHNBR B6B210	V 1000	24220472	-		○	
959,7	1009,70	166	166	BHNR B6A151	V 1000	24081474	-		○
960	990	22,8	25	94 AU 925	TM 20	49066491	-		○
	1000	18,7	20	PTFE GM201	OMS-S PR	49021789	-		○
	1010	100	100	BHNBR B4B210	ES	24073190	-		○
	1010	102	100	BHNBR B4B210	ES	24218709	-		○
	1010	230	230	BHNBR B6B210	V 1000	24192900	-		○
	1020	230	230	BHNBR B6B210	V 1000	24335109	-		○
962	1016	204,7	204,7	BHNR B6A151	V 1000	24250673	-		○
965	1025	230	230	BHNBR B6B210	V 1000	24353519	-		○
965,2	1016	200	200	BHNR B6A151	V 1000	24236771	-		○
970	1010	18,7	20	PTFE GM270	OMS-S	24359666	-		○
	1010	190	190	BHNR B6A151	V 1000	24369150	-		○
	1015	200	200	BHNR B6A151	V 1000	530045	-		○
	1020	150	150	BHNBR B6B210	V 1000	24369275	-		○
	1020	200	200	BHNBR B6B210	V 1000	24241332	-		○
	1020	230	230	BHNBR B6B210	V 1000	24102886	-		○
	1020	240	240	BHNBR B6B210	V 1000	24350502	-		○
	1020	240	240	BHNR B6A151	V 1000	24080866	-		○
972,5	1029,70	254	254	BHNBR B6B210	V 1000	24328803	-		○
975	1015	61,5	60	BHNBR B4B210	ES	24263162	-		○
	1025	37,5	40	80 NBR B246	Seal Set 0216	24361424	-		○
979,5	1035	170	170	BHNR B6A151	V 1000	24091677	-		○
980	1010	22,8	25	94 AU 925	TM 20	49066492	-		○
	1020	81,5	80	BHNBR B4B210	ES	24078616	-		○
	1030	190	190	BHNBR B6B210	V 1000	24295156	-		○
	1030	198	198	BHNR B6A151	V 1000	24174648	-		○
	1030	200	200	BHNBR B6B210	V 1000	24257977	-		○

d [mm]	D [mm]	H [mm]	L [mm]	Material	Design	Part No.	PU ¹⁾	US	EU
980	1030	230	230	BHNBR B6B210	V 1000	24246817	-		○
981,1	1044,60	254,2	254,2	BHNBR B6B210	V 1000	24366792	-		○
984,5	1048	228,6	228,6	BHNR B6A151	V 1000	49004264	-		○
989	1046,20	254	254	BHNBR B6B210	V 1000	24264136	-		○
990	1030	18,7	20	PTFE C104	OMS-S PR	49045107	-		○
1000	1030	22,8	25	93 AU V168	TM 20	24359555	-		○
	1030	22,8	25	94 AU 925	TM 20	49066493	-		○
	1040	18,7	20	PTFE B602	OMS-S	527858	-		○
	1040	18,7	20	PTFE GM201	OMS-S	24224757	-		○
	1040	18,7	20	PTFE GM201	OMS-S PR	49017447	-		○
	1040	61,5	60	BHNBR B4B210	ES	24267847	-		○
	1040	71,5	70	BHNBR B4B210	ES	24218710	-		○
	1040	81,5	80	BHNBR B4B210	ES	24071280	-		○
	1040	158	158	BHNBR B6B210	V 1000	24147569	-		○
	1050	36,4	40	93 AU V168	TM 20	24359792	-		○
	1050	37,5	40	80 NBR B246	Seal Set O214	24293084	-		○
	1050	37,5	40	80 NBR B246	Seal Set O216	24293083	-		○
	1050	100	100	BHNBR B4B210	ES	24114995	-		○
	1050	100	100	BHNBR B4B210	ES	24219155	-		○
	1050	102	100	BHNBR B4B210	ES	24137135	-		○
	1050	102	100	BHNBR B4B210	ES	24218712	-		○
	1050	155	155	BHNBR B6B210	V 1000	24239958	-		○
	1050	190	190	BHNBR B6B210	V 1000	24129229	-		○
	1050	200	200	BHNBR B6B210	V 1000	24086138	-		○
	1050	200	200	BHNBR B6B210	V 1000	24182397	-		○
1050	200	200	BHNR B6A151	V 1000	24116320	-		○	
1050	232	232	BHNBR B6B210	V 1000	24196695	-		○	
1050	240	240	BHNBR B6B210	V 1000	24334284	-		○	
1005	1055	190	190	BHNR B6A151	V 1000	24378180	-		○
	1055	200	200	BHNR B6A151	V 1000	24076148	-		○
	1055	230	230	BHNR B6A151	V 1000	24331235	-		○
1010	1060	200	200	BHNR B6A151	V 1000	24100515	-		○
	1060	240	240	BHNR B6A151	V 1000	24296535	-		○
	1060	240	240	BHNR B6A151	V 1000	24348850	-		○
	1070	190	190	BHNBR B6B210	V 1000	24292054	-		○
1016	1070	166	166	BHNBR B6B210	V 1000	24181632	-		○
1020	1060	158	158	BHNR B6A151	V 1000	24366888	-		○
	1070	102	100	BHNBR B4B210	ES	24343588	-		○
	1070	190	190	BHNBR B6B210	V 1000	24308168	-		○
1030	1080	200	200	BHNBR B6B210	V 1000	24096562	-		○
	1090	190	190	BHNR B6A151	V 1000	24377601	-		○
1039,60	1103,10	228,6	228,6	BHNBR B6B210	V 1000	24314891	-		○
1040	1070	22,8	25	93 AU V168	TM 20	49017258	-		○
	1090	150	150	BHNBR B6B210	V 1000	527294	-		○
	1090	230	230	BHNBR B6B210	V 1000	24290119	-		○
	1100	230	230	BHNBR B6B210	V 1000	24128707	-		○
1045	1095	190	190	BHNBR B6B210	V 1000	532553	-		○
	1100	202	202	BHNBR B6B210	V 1000	24349975	-		○
1050	1100	36,4	40	93 AU V168	TM 20	24359793	-		○
	1100	100	100	BHNBR B4B210	ES	24071553	-		○















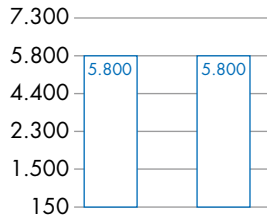
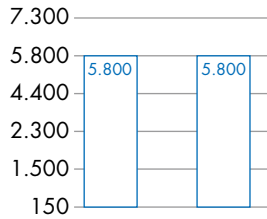
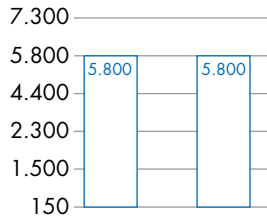
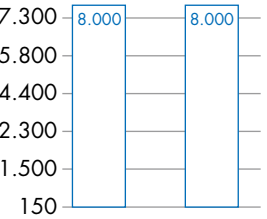
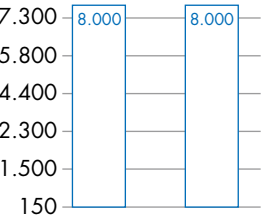
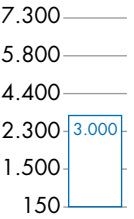

d [mm]	D [mm]	H [mm]	L [mm]	Material	Design	Part No.	PU ¹⁾	US	EU
1050	1100	150	150	BHNBR B6B210	V 1000	24298367	-		○
	1100	200	200	BHNR B6A151	V 1000	24073067	-		○
	1100	240	240	BHNBR B6B210	V 1000	24224913	-		○
	1110	190	190	BHNR B6A151	V 1000	24178267	-		○
1052,10	1098,60	92	92	BHNR B6A151	V 1000	24081728	-		○
1054,10	1094,10	92	92	BHNBR B5B210	V 1000	24312680	-		○
	1111,30	209,5	209,5	BHNR B6A151	V 1000	24112812	-		○
1060	1110	100	100	BHNBR B4B210	ES	24356608	-		○
	1110	200	200	BHNBR B6B210	V 1000	24106993	-		○
	1110	240	240	BHNBR B6B210	V 1000	24259444	-		○
	1120	230	230	BHNBR B6B210	V 1000	24355929	-		○
1062,60	1117,60	170	170	BHNR B6A151	V 1000	24375507	-		○
1065	1125	255	255	BHNBR B6B210	V 1000	24343940	-		○
1066,80	1117,60	134	134	BHNR B6A151	V 1000	24097943	-		○
	1117,60	198	198	BHNBR B6B210	V 1000	24257816	-		○
	1117,60	230	230	BHNBR B6B210	V 1000	24234460	-		○
	1123,80	267	267	BHNR B6A151	V 1000	24080781	-		○
1070	1110	18,7	20	PTFE B602	OMS-S	49020485	-		○
	1120	31	33	80 NBR B246	Seal Set O216	24361426	-		○
	1120	36,4	40	93 AU V168	TM 20	24359794	-		○
	1120	100	100	BHNBR B4B210	ES	24352076	-		○
	1120	198	198	BHNBR B6B210	V 1000	24144487	-		○
	1120	200	200	BHNBR B6B210	V 1000	24247168	-		○
	1120	240	240	BHNBR B6B210	V 1000	527844	-		○
1073,20	1130,20	267	267	BHNR B6A151	V 1000	24088679	-		○
1076,30	1130,30	230	230	BHNR B6A151	V 1000	24079273	-		○
1079,50	1136,50	267	267	BHNBR B6B210	V 1000	24258839	-		○
1080	1130	102	100	BHNBR B4B210	ES	24359160	-		○
	1130	232	232	BHNBR B6B210	V 1000	24181601	-		○
1085,90	1136,70	190	190	BHNBR B6B210	V 1000	531515	-		○
1090	1140	200	200	BHNBR B6B210	V 1000	24267966	-		○
	1150	150	150	BHNBR B6B210	V 1000	24293366	-		○
	1150	230	230	BHNBR B6B210	V 1000	24237917	-		○
1095	1140	200	200	BHNBR B6B210	V 1000	24308237	-		○
1097	1147	166	166	BHNR B6A151	V 1000	24339747	-		○
1100	1140	80	80	BHNBR B4B210	ES	24098392	-		○
	1140	92	92	BHNBR B5B210	V 1000	24330401	-		○
	1150	102	100	BHNBR B4B210	ES	24122700	-		○
	1150	166	166	BHNR B6A151	V 1000	24231177	-		○
	1150	190	190	BHNBR B6B210	V 1000	24258316	-		○
	1150	192	192	BHNBR B6B210	V 1000	24334775	-		○
	1150	200	200	BHNBR B6B210	V 1000	531956	-		○
	1150	240	240	BHNBR B6B210	V 1000	24375373	IP		●
	1155	202	202	BHNBR B6B210	V 1000	24302975	-		○
	1160	120	120	BHNBR B6B210	V 1000	24342314	-		○
	1160	150	150	BHNBR B6B210	V 1000	24308567	-		○
	1160	230	230	BHNBR B4B210	V 1000	24335697	-		○
1104,90	1162	274,6	274,6	BHNBR B6B210	V 1000	24142573	-		○
1109	1163,50	170	170	BHNBR B6B210	V 1000	24359333	-		○
1117,60	1168,40	134	134	BHNBR B6B210	V 1000	24101361	-		○

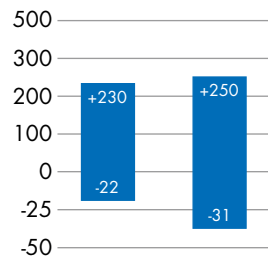
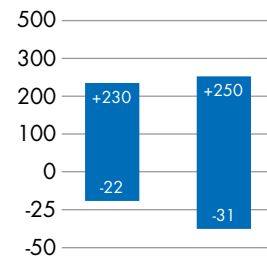
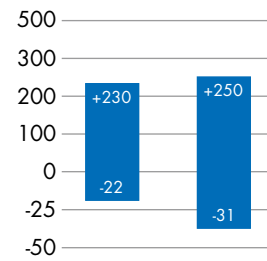
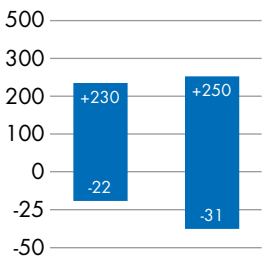
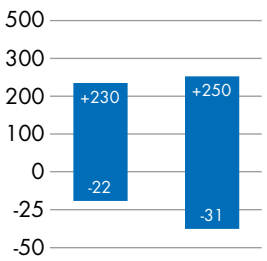
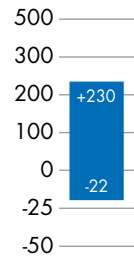
d [mm]	D [mm]	H [mm]	L [mm]	Material	Design	Part No.	PU ¹⁾	US	EU
1117,60	1174,80	228,7	228,7	BHNR B6A151	V 1000	24140474	-		○
1120	1147,30	8,7	9,5	PTFE GM270/NBR	OMS-MR	24368301	-		○
	1158	12,9	13,8	PTFE C104	OSES-0161	49017760	-		○
	1175	202	202	BHNR B6A151	V 1000	24298900	-		○
1125	1175	166	166	BHNR B6A151	V 1000	24360243	-		○
1126	1183	222,5	222,5	BHNR B6A151	V 1000	24333773	-		○
1128	1180,40	203,1	203,1	BHNR B6A151	V 1000	49004452	-		○
1129	1179	230	230	BHNR B6A151	V 1000	24264862	-		○
1130	1170	60	60	BHNR B4B210	ES	24144932	-		○
	1180	200	200	BHNR B6B210	V 1000	24240334	-		○
	1180	200	200	BHNR B6A151	V 1000	24114963	-		○
	1180	230	230	BHNR B6A151	V 1000	24131469	-		○
	1180	240	240	BHNR B6B210	V 1000	24261525	-		○
	1190	230	230	BHNR B6A151	V 1000	24345073	-		○
1135	1185	200	200	BHNR B6B210	V 1000	24221089	-		○
1140	1195	170	170	BHNR B6B210	V 1000	24342446	-		○
	1200	190	190	BHNR B6A151	V 1000	24330168	-		○
	1200	230	230	BHNR B6A151	V 1000	24242440	-		○
1150	1200	36,4	40	93 AU V168	TM 20	24359795	-		○
	1200	70	70	BHNR B4B210	ES	24175251	-		○
	1200	200	200	BHNR B6B210	V 1000	24259601	-		○
	1200	200	200	BHNR B6A151	V 1000	24331570	-		○
	1210	230	230	BHNR B6A151	V 1000	24334683	-		○
1155	1205	192	192	BHNR B6B210	V 1000	24370895	-		○
1155,70	1206,50	123	123	BHNR B6B210	V 1000	24350823	-		○
1160	1220	190	190	BHNR B6B210	V 1000	49002402	-		○
	1220	230	230	BHNR B6B210	V 1000	24145531	-		○
1165	1215	200	200	BHNR B6B210	V 1000	24366916	-		○
1168,40	1219,20	206	206	BHNR B6B210	V 1000	24234270	-		○
	1225,60	228,7	228,7	BHNR B6B210	V 1000	24332345	-		○
	1225,60	254	254	BHNR B6A151	V 1000	49003223	-		○
	1225,60	273,2	273,2	BHNR B6A151	V 1000	24097438	-		○
1170	1220	200	200	BHNR B6B210	V 1000	24107499	-		○
	1230	210	210	BHNR B6B210	V 1000	24334130	-		○
1180	1235	138	138	BHNR B6B210	V 1000	24349940	-		○
1200	1250	36,4	40	93 AU V168	TM 20	24362258	-		○
	1250	190	190	BHNR B6B210	V 1000	24085683	-		○
	1250	190	190	BHNR B6A151	V 1000	24267770	-		○
	1250	200	200	BHNR B6B210	V 1000	24075198	-		○
	1260	230	230	BHNR B6A151	V 1000	24137108	-		○
1206,50	1270	209,7	209,7	BHNR B6A151	V 1000	24350653	-		○
1210	1260	134	134	BHNR B6B210	V 1000	24249176	-		○
	1273,50	228,6	228,6	BHNR B6A151	V 1000	49004267	-		○
1219,10	1271,50	158,7	158,7	BHNR B6A151	V 1000	24329263	-		○
1219,20	1270	123	120	BHNR B6B210	V 1000	24170559	-		○
	1270	200	200	BHNR B6A151	V 1000	24175602	-		○
	1271,60	169,8	169,8	BHNR B6A151	V 1000	24119656	-		○
1220	1260	190	190	BHNR B6B210	V 1000	24239738	-		○
	1270	100	100	BHNR B4B210	ES	24335019	-		○
	1280	230	230	BHNR B6B210	V 1000	24267791	-		○

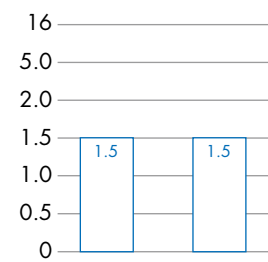
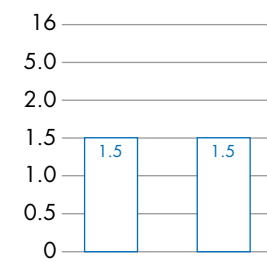
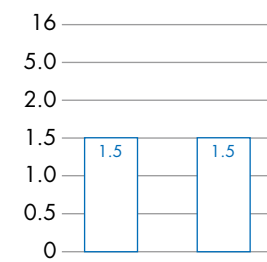
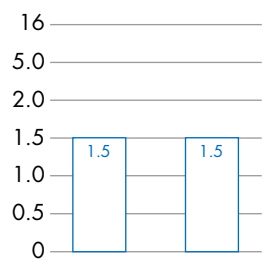
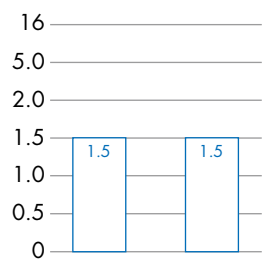
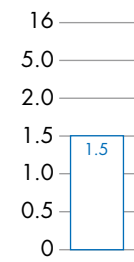
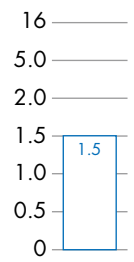
d [mm]	D [mm]	H [mm]	L [mm]	Material	Design	Part No.	PU ¹⁾	US	EU
1225	1275	208	208	BHNBR B6B210	V 1000	24234823	-		○
	1285	190	190	BHNR B6A151	V 1000	49005205	-		○
1230	1270	110	110	BHNBR B5B210	V 1000	528168	-		○
	1280	166	166	BHNBR B6B210	V 1000	24348179	-		○
	1280	176	176	BHNBR B6B210	V 1000	24344206	-		○
	1280	192	192	BHNBR B6B210	V 1000	24236024	-		○
	1280	230	230	BHNBR B6B210	V 1000	530996	-		○
	1290	190	190	BHNBR B6B210	V 1000	24349950	-		○
	1290	190	190	BHNR B6A151	V 1000	24374033	-		○
	1290	230	230	BHNBR B6B210	V 1000	24312116	-		○
1230,30	1287,50	211,1	211,1	BHNR B6A151	V 1000	24291581	-		○
1235	1285	200	200	BHNBR B6B210	V 1000	24263220	-		○
1240	1290	200	200	BHNR B6A151	V 1000	24178335	-		○
	1290	240	240	BHNBR B6B210	V 1000	532513	-		○
	1300	230	230	BHNBR B6B210	V 1000	24137932	-		○
	1300	250	250	BHNBR B6B210	V 1000	24183326	-		○
1248	1308	240	240	BHNBR B6B210	V 1000	24298832	-		○
1250	1290	18,7	20	PTFE GM201	OMS-S PR	49010934	-		○
	1300	36,4	40	93 AU V168	TM 20	24359556	-		○
	1300	150	150	BHNBR B6B210	V 1000	527800	-		○
	1300	200	200	BHNBR B6B210	V 1000	24173519	-		○
1251	1308,20	254	254	BHNBR B6B210	V 1000	24232553	-		○
1260	1300	110	110	BHNBR B5B210	V 1000	24212921	-		○
	1310	200	200	BHNBR B6B210	V 1000	24095757	-		○
1266,80	1324	209,5	209,5	BHNBR B6B210	V 1000	24257818	-		○
1268	1320,40	161,7	161,7	BHNBR B6B210	V 1000	24378200	-		○
1270	1320	200	200	BHNBR B6B210	V 1000	24257632	-		○
	1320	230	230	BHNBR B6B210	V 1000	24093634	-		○
	1330	230	230	BHNBR B6B210	V 1000	24334560	-		○
1285	1335	240	240	BHNBR B6B210	V 1000	24373810	-		○
1295,40	1346,20	149	149	BHNBR B6B210	V 1000	24258445	-		○
1300	1350	190	190	BHNBR B6B210	V 1000	49001278	-		○
	1350	200	200	BHNBR B6B210	V 1000	24199574	-		○
	1360	240	240	BHNR B6A151	V 1000	24261978	-		○
1305	1355	240	240	BHNBR B6B210	V 1000	24315736	-		○
1320	1370	200	200	BHNBR B6B210	V 1000	24360154	-		○
	1370	240	240	BHNBR B6B210	V 1000	525603	-		○
1325	1375	230	230	BHNBR B6B210	V 1000	24244763	-		○
1340	1400	140	140	BHNBR B6B210	V 1000	24104682	-		○
1346	1400	216,3	216,3	BHNR B6A151	V 1000	24100249	-		○
1349,60	1400,40	216	216	BHNR B6A151	V 1000	24089993	-		○
1350	1400	152	152	BHNBR B6B210	V 1000	24369103	-		○
	1400	200	200	BHNBR B6B210	V 1000	24198469	-		○
	1400	230	230	BHNBR B6B210	V 1000	24378450	-		○
	1400	240	240	BHNBR B6B210	V 1000	24315732	-		○
1360	1410	200	200	BHNBR B6B210	V 1000	24356885	-		○
	1410	200	200	BHNR B6A151	V 1000	24378377	-		○
1360,30	1430,30	149	149	BHNR B6A151	V 1000	24132615	-		○
1370	1430	180	180	BHNR B6A151	V 1000	24180183	-		○
1375	1430	170	170	BHNR B6A151	V 1000	24178268	-		○

d [mm]	D [mm]	H [mm]	L [mm]	Material	Design	Part No.	PU ¹⁾	US	EU
	1430	166	166	BHNBR B6B210	V 1000	24314231	-		○
	1430	190	190	BHNR B6A151	V 1000	24348888	-		○
	1430	200	200	BHNBR B6B210	V 1000	24142545	-		○
1380	1430	200	200	BHNR B6A151	V 1000	24340271	-		○
	1430	230	230	BHNBR B6B210	V 1000	24177187	-		○
	1430	230	230	BHNR B6A151	V 1000	24173720	-		○
	1434	190	190	BHNR B6A151	V 1000	24116610	-		○
	1440	190	190	BHNBR B6B210	V 1000	531928	-		○
1384,30	1435,10	190	190	BHNBR B6B210	V 1000	24349941	-		○
1385	1435	240	240	BHNBR B6B210	V 1000	24297822	-		○
1400	1450	200	200	BHNR B6A151	V 1000	24250631	-		○
	1460	190	190	BHNBR B6B210	V 1000	24085195	-		○
1420	1470	200	200	BHNR B6A151	V 1000	24081831	-		○
	1470	240	240	BHNBR B6B210	V 1000	24375863	-		○
1425	1475	190	190	BHNBR B6B210	V 1000	24358494	-		○
1430	1490	250	250	BHNBR B6B210	V 1000	528516	-		○
1447,80	1497,80	230	230	BHNBR B6B210	V 1000	24373815	-		○
1448,50	1503,50	202	202	BHNR B6A151	V 1000	24287873	-		○
	1512	209,7	209,7	BHNR B6A151	V 1000	24359266	-		○
1450	1500	190	190	BHNBR B6B210	V 1000	24334552	-		○
	1500	200	200	BHNBR B6B210	V 1000	49002455	-		○
	1510	210	210	BHNBR B6B210	V 1000	24234563	-		○
	1510	230	230	BHNBR B6B210	V 1000	24302543	-		○
1454,10	1511,30	254	254	BHNBR B6B210	V 1000	24262791	-		○
1457	1517	255	255	BHNBR B6B210	V 1000	24230702	-		○
	1510	200	200	BHNBR B6B210	V 1000	532968	-		○
1460	1510	200	200	BHNR B6A151	V 1000	24087347	-		○
	1520	230	230	BHNBR B6B210	V 1000	530835	-		○
1470	1520	230	230	BHNR B6A151	V 1000	24299585	-		○
1480	1530	200	200	BHNBR B6B210	V 1000	24370971	-		○
1482	1542	240	240	BHNBR B6B210	V 1000	24306013	-		○
1490	1560	184	184	BHNR B6A151	V 1000	525042	-		○
1500	1550	200	200	BHNBR B6B210	V 1000	24194257	-		○
	1560	210	210	BHNR B6A151	V 1000	24362972	-		○
1511,30	1568,50	273,2	273,2	BHNR B6A151	V 1000	24349946	-		○
	1570	200	200	BHNBR B6B210	V 1000	24092672	-		○
1520	1570	200	200	BHNR B6A151	V 1000	24142729	-		○
	1570	200	200	BHNR B6A151	V 1000	24180710	-		○
1524	1576,40	169,8	169,8	BHNR B6A151	V 1000	24102377	-		○
	1600	200	200	BHNBR B6B210	V 1000	24290204	-		○
1550	1600	200	200	BHNR B6A151	V 1000	24137633	-		○
	1600	240	240	BHNBR B6B210	V 1000	24302319	-		○
1560	1620	255	255	BHNR B6A151	V 1000	531076	-		○
1568,50	1638,50	219	219	BHNR B6A151	V 1000	24352619	-		○
1600	1650	200	200	BHNR B6A151	V 1000	24374580	-		○
	1650	240	240	BHNBR B6B210	V 1000	24300926	-		○
1630	1680	200	200	BHNR B6A151	V 1000	24197262	-		○
	1684	213,8	213,8	BHNR B6A151	V 1000	24328710	-		○
1651	1701	120	120	BHNBR B6B210	V 1000	24134928	-		○
1651,10	1701,90	113	113	BHNBR B6B210	V 1000	530694	-		○

d [mm]	D [mm]	H [mm]	L [mm]	Material	Design	Part No.	PU ¹⁾	US	EU
1651,10	1701,90	124	124	BHNBR B6B210	V 1000	24143498	-		○
1660	1720	210	210	BHNBR B6B210	V 1000	24302204	-		○
1670	1730	210	210	BHNR B6A151	V 1000	24263417	-		○
1676,40	1727,20	240	240	BHNBR B6B210	V 1000	24377802	-		○
1700	1760	255	255	BHNBR B6B210	V 1000	24370764	-		○
1701,80	1759	209,5	209,5	BHNBR B6B210	V 1000	24181197	-		○
1727,20	1784,40	273,2	273,2	BHNBR B6B210	V 1000	24182245	-		○
1750	1800	240	240	BHNBR B6B210	V 1000	24332511	-		○
1800	1850	200	200	BHNBR B6B210	V 1000	24148688	-		○
1828,80	1886	228,7	228,7	BHNR B6A151	V 1000	24126941	-		○
1850	1910	255	255	BHNBR B6B210	V 1000	24332316	-		○
1955	2018,50	254	254	BHNBR B6B210	V 1000	531255	-		○
1960	2020	250	250	BHNBR B6B210	V 1000	527794	-		○
	2020	250	250	BHNR B6A151	V 1000	24259162	-		○
2000	2060	190	190	BHNBR B6B210	V 1000	24082656	-		○
	2060	230	230	BHNBR B6B210	V 1000	24294539	-		○
2450	2510	190	190	BHNBR B6B210	V 1000	24378196	-		○

Type	RO		D 300		HBY		SYM	LSU
Standard	AS		AS		AS		AS	AS
Shape								
Compound	Polyurethan 92 AU 9250	Polyurethan 94 AU 30000	Polyurethan 92 AU 9250	Polyurethan 94 AU 30000	Polyurethan / PA 92 AU 9250/80NP	Polyurethan / PA 94 AU 30000/80NP	Polyurethan 92 AU 9250	Polyurethan / NBR 93 AU 2093 N3101
								
								
								
Applications								

Bitte beachten Sie unsere allgemeinen Konstruktionshinweise in → Technisches Handbuch
 Daha detaylı montaj bilgisi için → Bkz. Technical Manual
 W celu zaznajomienia się z ogólnymi uwagami proszę skorzystać z Instrukcji
 Общие технические рекомендации см. → Техническое руководство

STANGEN- UND SYMMETRISCHE DICHTUNGEN | ROD VE SIMETRIK SIZDIRMAZLIK ELEMANLARI USZCZELNIENIA TŁOCZYSKA ORAZ SYMETRYCZNE | ШТОКОВЫЕ И СИММЕТРИЧНЫЕ УПЛОТНЕНИЯ

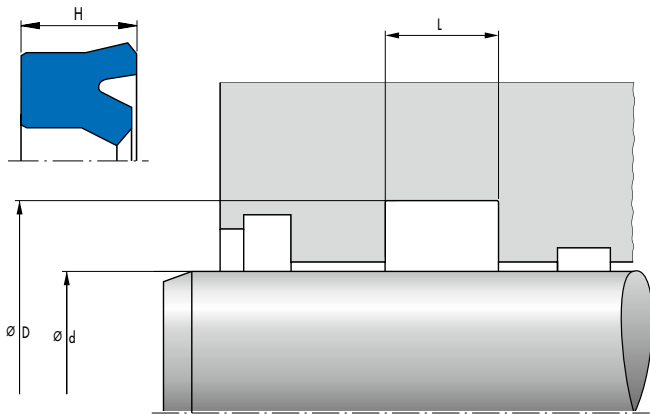

Wenn Sie Ihre Dichtung nicht finden können – Ihre Lösung auf Seite 12
 Aradığınız ürünü bulamadığınız takdirde – çözümünüz sayfa 12
 Jeżeli nie możecie Państwo znaleźć uszczelki – rozwiązanie znajduje się na stronie 12
 Вы не можете подобрать необходимое уплотнение? – Решение на странице 12

1) IP = Industriepackung | Endüstriyel ambalaj | Opakowania przemysłowe | Производственная тара
 SP = Einzelpackung | Tek bir Paketi | Pojedyncze opakowanie | Single Pack

● Auf Lager | Stoklarda mevcuttur | Dostępne w magazynie | Имеется в наличии на складе
 ○ Auf Anfrage | Talep üzerine | Na zapytanie | По запросу

d [inch]	D [inch]	H [inch]	L [inch]	Material	Design	Part No.	PU ¹⁾	US	EU
0,125	0,375	0,125	0,156	92 AU 9250	SYM	5600050030D0A	–	●	
	0,375	0,188	0,218	92 AU 9250	SYM	5600050020D0A	–	○	
	0,375	0,25	0,275	93 AU 2093 / N3101	LSU	12500125250B-2093	–	○	
	0,375	0,25	0,281	92 AU 9250	SYM	5600050010D0A	–	○	
0,187	0,437	0,125	0,138	93 AU 2093 / N3101	LSU	125001875QB-2093	–	○	
	0,562	0,188	0,207	93 AU 2093 / N3101	LSU	18700187-2093	–	●	
	0,438	0,125	0,138	93 AU 2093 / N3101	LSU	12500187-2093	–	○	
0,188	0,438	0,125	0,156	92 AU 9250	SYM	5600050060D0A	–	●	
	0,438	0,188	0,218	92 AU 9250	SYM	5600050050D0A	–	●	
	0,438	0,25	0,275	93 AU 2093 / N3101	LSU	12500187250B-2093	–	●	
	0,438	0,25	0,281	92 AU 9250	SYM	5600050040D0A	–	●	
0,25	0,5	0,125	0,138	93 AU 2093 / N3101	LSU	12500250-2093	–	●	
	0,5	0,125	0,138	93 AU 2093 / N3101	LSU	12500250SQB-2093	–	○	
	0,5	0,125	0,156	92 AU 9250	SYM	5600050090D0A	–	●	
	0,5	0,125	0,156	92 AU 9250	SYM	5600050090S0A	–	○	
	0,5	0,188	0,207	93 AU 2093 / N3101	LSU	12500250187B-2093	–	○	
	0,5	0,188	0,218	92 AU 9250	SYM	5600050080D0A	–	●	
	0,5	0,25	0,275	93 AU 2093 / N3101	LSU	12500250250B-2093	–	○	
	0,5	0,25	0,281	92 AU 9250	SYM	5600050070D0A	–	●	
	0,625	0,188	0,218	92 AU 9250	SYM	560005012000A	–	●	
	0,625	0,25	0,281	92 AU 9250	SYM	560005011000A	–	●	
	0,625	0,313	0,343	92 AU 9250	SYM	560005010000A	–	○	
	0,75	0,25	0,275	93 AU 2093 / N3101	LSU	25000250-2093	–	○	
	0,75	0,313	0,343	92 AU 9250	SYM	560005014000A	–	○	
0,75	0,375	0,406	92 AU 9250	SYM	560005013000A	–	○		
0,312	0,562	0,125	0,138	93 AU 2093 / N3101	LSU	125003125QB-2093	–	○	
	0,562	0,145	0,156	92 AU 9250	SYM	560005018Y00A	–	○	
	0,562	0,25	0,275	93 AU 2093 / N3101	LSU	12500312250B-2093	–	○	
0,313	0,563	0,125	0,138	93 AU 2093 / N3101	LSU	12500312-2093	–	●	
	0,563	0,125	0,156	92 AU 9250	SYM	5600050180D0A	–	●	

d [inch]	D [inch]	H [inch]	L [inch]	Material	Design	Part No.	PU ¹⁾	US	EU	
0,313	0,563	0,125	0,156	92 AU 9250	SYM	5600050180S0A	-	●		
	0,563	0,188	0,218	92 AU 9250	SYM	5600050170D0A	-	●		
	0,563	0,25	0,281	92 AU 9250	SYM	5600050160D0A	-	●		
	0,563	0,25	0,281	92 AU 9250	SYM	5600050160S0A	-	○		
	0,688	0,188	0,207	93 AU 2093 / N3101	LSU	18700312-2093	-	○		
	0,688	0,313	0,344	93 AU 2093 / N3101	LSU	18700312312B-2093	-	○		
	0,813	0,25	0,281	92 AU 9250	SYM	560005021000A	-	○		
0,375	0,625	0,125	0,138	93 AU 2093 / N3101	LSU	12500375-2093	-	●		
	0,625	0,125	0,156	92 AU 9250	SYM	5600050240D0A	-	●		
	0,625	0,125	0,156	92 AU 9250	SYM	5600050240S0A	-	●		
	0,625	0,188	0,207	93 AU 2093 / N3101	LSU	12500375187B-2093	-	●		
	0,625	0,188	0,218	92 AU 9250	SYM	5600050230D0A	-	●		
	0,625	0,188	0,218	92 AU 9250	SYM	5600050230S0A	-	○		
	0,625	0,25	0,275	93 AU 2093 / N3101	LSU	12500375250B-2093	-	○		
	0,625	0,25	0,281	92 AU 9250	SYM	5600050220D0A	-	●		
	0,625	0,25	0,281	92 AU 9250	SYM	5600050220S0A	-	●		
	0,75	0,188	0,207	93 AU 2093 / N3101	LSU	18700375-2093	-	●		
	0,75	0,188	0,218	92 AU 9250	SYM	560005027000A	-	○		
	0,75	0,25	0,281	92 AU 9250	SYM	560005026000A	-	●		
	0,75	0,313	0,343	92 AU 9250	SYM	560005025000A	-	●		
	0,75	0,313	0,344	93 AU 2093 / N3101	LSU	18700375312B-2093	-	○		
	0,875	0,25	0,281	92 AU 9250	SYM	560005030000A	-	○		
	0,875	0,313	0,343	92 AU 9250	SYM	560005029000A	-	○		
	0,875	0,375	0,406	92 AU 9250	SYM	5600050280D0A	-	○		
0,437	1	0,313	0,344	93 AU 2093 / N3101	LSU	31200375-2093	-	○		
0,437	0,812	0,188	0,207	93 AU 2093 / N3101	LSU	18700437-2093	-	●		
	0,688	0,125	0,138	93 AU 2093 / N3101	LSU	12500437-2093	-	○		
	0,688	0,125	0,156	92 AU 9250	SYM	560005033000A	-	○		
	0,688	0,125	0,156	92 AU 9250	SYM	5600050330D0A	-	●		
	0,688	0,188	0,218	92 AU 9250	SYM	5600050320D0A	-	○		
	0,688	0,188	0,218	92 AU 9250	SYM	5600050320S0A	-	○		
	0,688	0,25	0,275	93 AU 2093 / N3101	LSU	12500437250B-2093	-	○		
	0,688	0,25	0,281	92 AU 9250	SYM	5600050310D0A	-	●		
	0,813	0,313	0,344	93 AU 2093 / N3101	LSU	18700437312B-2093	-	○		
0,438	0,938	0,25	0,275	93 AU 2093 / N3101	LSU	25000437-2093	-	○		
	0,938	0,375	0,413	93 AU 2093 / N3101	LSU	25000437375B-2093	-	○		
	0,498	1	0,357	0,392	92 AU 9250	SYM	560005040Y00A	-	●	
	0,5	0,75	0,125	0,138	93 AU 2093 / N3101	LSU	12500500-2093	-	●	
		0,75	0,125	0,156	92 AU 9250	SYM	5600050360D0A	-	●	
		0,75	0,125	0,156	92 AU 9250	SYM	5600050360D0A-H	-	●	
		0,75	0,188	0,218	92 AU 9250	SYM	5600050350D0A	-	●	
		0,75	0,25	0,281	92 AU 9250	SYM	5600050340D0A	-	●	
		0,75	0,25	0,281	92 AU 9250	SYM	5600050340S0A	-	●	
0,875		0,188	0,207	93 AU 2093 / N3101	LSU	18700500-2093	-	○		
0,875		0,188	0,207	93 AU 2093 / N3101	LSU	18700500SQB-2093	-	○		
0,875		0,188	0,218	92 AU 9250	SYM	560005039000A	-	●		
0,875		0,25	0,281	92 AU 9250	SYM	560005038000A	-	○		
0,875		0,313	0,343	92 AU 9250	SYM	560005037000A	-	●		
1		0,25	0,275	93 AU 2093 / N3101	LSU	25000500-2093	-	●		
1		0,25	0,275	93 AU 2093 / N3101	LSU	25000500SQB-2093	-	○		

d [inch]	D [inch]	H [inch]	L [inch]	Material	Design	Part No.	PU ¹⁾	US	EU	
0,5	1	0,25	0,281	92 AU 9250	SYM	560005042000A	-	●		
	1	0,375	0,406	92 AU 9250	SYM	560005040000A	-	○		
	1	0,375	0,413	93 AU 2093 / N3101	LSU	25000500375-2093	-	○		
	1,125	0,313	0,344	93 AU 2093 / N3101	LSU	31200500-2093	-	○		
0,562	0,812	0,125	0,138	93 AU 2093 / N3101	LSU	12500562SQB-2093	-	○		
	0,937	0,188	0,207	93 AU 2093 / N3101	LSU	18700562-2093	-	○		
0,563	0,813	0,125	0,156	92 AU 9250	SYM	5600050450D0A	-	●		
	0,813	0,188	0,218	92 AU 9250	SYM	5600050440D0A	-	○		
	0,813	0,25	0,275	93 AU 2093 / N3101	LSU	12500562250B-2093	-	○		
	0,813	0,25	0,281	92 AU 9250	SYM	5600050430D0A	-	○		
	0,938	0,188	0,218	92 AU 9250	SYM	560005048000A	-	○		
	0,938	0,188	0,218	92 AU 9250	SYM	5600050480D0A	-	○		
	0,938	0,25	0,281	92 AU 9250	SYM	560005047000A	-	○		
	0,938	0,313	0,343	92 AU 9250	RO	560001030000A	-	○		
	0,938	0,313	0,343	92 AU 9250	SYM	560005046000A	-	○		
	0,938	0,313	0,344	93 AU 2093 / N3101	LSU	18700562312B-2093	-	○		
	1,063	0,25	0,275	93 AU 2093 / N3101	LSU	25000562-2093	-	○		
0,625	0,875	0,125	0,138	93 AU 2093 / N3101	LSU	12500625-2093	-	●		
	0,875	0,125	0,138	93 AU 2093 / N3101	LSU	12500625SQB-2093	-	●		
	0,875	0,125	0,156	94 AU 30000	RO	560001035000B	-	●		
	0,875	0,125	0,156	92 AU 9250	SYM	5600050540D0A	-	●		
	0,875	0,14	0,156	92 AU 9250	SYM	560005054ZD0A	-	○		
	0,875	0,188	0,207	93 AU 2093 / N3101	LSU	12500625187-2093	-	●		
	0,875	0,188	0,207	93 AU 2093 / N3101	LSU	12500625187B-2093	-	●		
	0,875	0,188	0,218	92 AU 9250	D 300	560G01384000A	-	○		
	0,875	0,188	0,218	94 AU 30000	RO	560001034000B	-	●		
	0,875	0,188	0,218	92 AU 9250	SYM	5600050530D0A	-	●		
	0,875	0,25	0,281	92 AU 9250	RO	560001033000A	-	●		
	0,875	0,25	0,281	92 AU 9250	SYM	5600050520D0A	-	●		
	1	0,188	0,207	93 AU 2093 / N3101	LSU	18700625-2093	-	●		
	1	0,188	0,207	93 AU 2093 / N3101	LSU	18700625SQB-2093	-	○		
	1	0,188	0,218	92 AU 9250	SYM	560005057000A	-	●		
	1	0,202	0,218	94 AU 30000	RO	560001038000B	-	●		
	1	0,25	0,281	92 AU 9250	RO	560001037000A	-	○		
	1	0,25	0,281	92 AU 9250	SYM	560005056000A	-	●		
	1	0,313	0,343	92 AU 9250	RO	560001036000A	-	○		
	1	0,313	0,343	92 AU 9250	SYM	560005055000A	-	●		
1	0,313	0,344	93 AU 2093 / N3101	LSU	18700625312B-2093	-	○			
0,687	1,125	0,25	0,275	93 AU 2093 / N3101	LSU	25000625-2093	-	●		
	1,125	0,25	0,281	92 AU 9250	SYM	560005060000A	-	●		
	1,125	0,375	0,406	92 AU 9250	SYM	560005058000A	-	●		
	1,125	0,375	0,413	93 AU 2093 / N3101	LSU	25000625375B-2093	-	○		
	0,937	0,25	0,275	93 AU 2093 / N3101	LSU	12500687250B-2093	-	●		
	1,062	0,188	0,207	93 AU 2093 / N3101	LSU	18700687-2093	-	○		
	0,688	0,938	0,125	0,138	93 AU 2093 / N3101	LSU	12500687-2093	-	○	
		1,063	0,188	0,218	92 AU 9250	RO	560001041000A	-	○	
		1,063	0,25	0,281	92 AU 9250	RO	560001040000A	-	○	
		1,063	0,313	0,343	92 AU 9250	RO	560001039000A	-	○	
1,188		0,25	0,275	93 AU 2093 / N3101	LSU	25000687-2093	-	○		
1,188		0,25	0,281	92 AU 9250	SYM	560005067000A	-	○		

d [inch]	D [inch]	H [inch]	L [inch]	Material	Design	Part No.	PU ¹⁾	US	EU
0,688	1,188	0,375	0,406	92 AU 9250	SYM	560005065000A	-	●	
	1,313	0,313	0,344	93 AU 2093 / N3101	LSU	31200687-2093	-	○	
0,75	1	0,125	0,138	93 AU 2093 / N3101	LSU	12500750-2093	-	○	
	1	0,125	0,138	93 AU 2093 / N3101	LSU	12500750SQB-2093	-	○	
	1	0,125	0,156	94 AU 30000	RO	560001044000B	-	●	
	1	0,125	0,156	92 AU 9250	SYM	5600050700D0A	-	●	
	1	0,14	0,156	92 AU 9250	RO	560001044000A-RED	-	○	
	1	0,16	0,218	92 AU 9250	SYM	560005068ZD0A	-	○	
	1	0,171	0,187	92 AU 9250	RO	560001042B00A	-	○	
	1	0,188	0,207	93 AU 2093 / N3101	LSU	12500750187-2093	-	○	
	1	0,188	0,207	93 AU 2093 / N3101	LSU	12500750187B-2093	-	●	
	1	0,188	0,218	92 AU 9250	RO	560001043000A	-	○	
	1	0,188	0,218	92 AU 9250	SYM	5600050690D0A	-	●	
	1	0,25	0,275	93 AU 2093 / N3101	LSU	12500750250-2093	-	○	
	1	0,25	0,275	93 AU 2093 / N3101	LSU	12500750250B-2093	-	○	
	1	0,25	0,281	94 AU 30000	D 300	560G01042000B	-	●	
	1	0,25	0,281	94 AU 30000	RO	560001042000B	-	●	
	1	0,25	0,281	92 AU 9250	SYM	5600050680D0A	-	●	
	1	0,25	0,281	92 AU 9250	SYM	5600050680S0A	-	○	
	1,125	0,156	0,172	93 AU 2093 / N3101	LSU	15600750-2093	-	○	
	1,125	0,188	0,207	93 AU 2093 / N3101	LSU	18700750-2093	-	●	
	1,125	0,188	0,207	93 AU 2093 / N3101	LSU	18700750SQB-2093	-	○	
	1,125	0,188	0,218	92 AU 9250	RO	560001047000A	-	●	
	1,125	0,188	0,218	92 AU 9250	SYM	560005073000A	-	●	
	1,125	0,25	0,275	93 AU 2093 / N3101	LSU	18700750250B-2093	-	○	
	1,125	0,25	0,281	94 AU 30000	D 300	560G01046000B	-	●	
	1,125	0,25	0,281	92 AU 9250	SYM	560005072000A	-	●	
	1,125	0,313	0,343	92 AU 9250	D 300	560G01045000A	-	●	
	1,125	0,313	0,343	94 AU 30000	RO	560001045000B	-	●	
1,125	0,313	0,343	92 AU 9250	SYM	560005071000A	-	○		
1,125	0,313	0,344	93 AU 2093 / N3101	LSU	18700750312B-2093	-	○		
1,25	0,25	0,275	93 AU 2093 / N3101	LSU	25000750-2093	-	●		
1,25	0,25	0,275	93 AU 2093 / N3101	LSU	25000750SQB-2093	-	○		
1,25	0,25	0,281	92 AU 9250	SYM	560005076000A	-	●		
1,25	0,375	0,406	92 AU 9250	SYM	560005074000A	-	○		
1,25	0,375	0,413	93 AU 2093 / N3101	LSU	25000750375B-2093	-	○		
1,375	0,313	0,344	93 AU 2093 / N3101	LSU	31200750-2093	-	○		
1,375	0,5	0,55	93 AU 2093 / N3101	LSU	31200750500B-2093	-	○		
1,5	0,375	0,413	93 AU 2093 / N3101	LSU	37500750-2093	-	○		
0,813	1,063	0,125	0,138	93 AU 2093 / N3101	LSU	12500812-2093	-	○	
	1,063	0,125	0,156	92 AU 9250	SYM	5600050790D0A	-	○	
	1,063	0,188	0,218	94 AU 30000	RO	560001049000B	-	●	
	1,063	0,25	0,275	93 AU 2093 / N3101	LSU	12500812250B-2093	-	○	
	1,063	0,25	0,281	92 AU 9250	SYM	5600050770D0A	-	○	
	1,188	0,188	0,207	93 AU 2093 / N3101	LSU	18700812-2093	-	○	
	1,188	0,25	0,281	92 AU 9250	RO	560001052000A	-	○	
	1,188	0,25	0,281	92 AU 9250	SYM	560005081000A	-	○	
	1,188	0,313	0,343	92 AU 9250	RO	560001051000A	-	●	
	1,313	0,25	0,281	92 AU 9250	SYM	560005085000A	-	○	
1,313	0,375	0,406	92 AU 9250	SYM	560005083000A	-	○		

d [inch]	D [inch]	H [inch]	L [inch]	Material	Design	Part No.	PU ¹⁾	US	EU
0,875	1,125	0,125	0,138	93 AU 2093 / N3101	LSU	12500875-2093	-	○	
	1,125	0,125	0,138	93 AU 2093 / N3101	LSU	12500875SQB-2093	-	○	
	1,125	0,125	0,156	92 AU 9250	RO	560001056000A	-	●	
	1,125	0,125	0,156	92 AU 9250	SYM	5600050880D0A	-	●	
	1,125	0,172	0,187	92 AU 9250	SYM	560005086ZD0A	-	●	
	1,125	0,188	0,207	93 AU 2093 / N3101	LSU	12500875187B-2093	-	●	
	1,125	0,188	0,218	92 AU 9250	RO	560001055000A	-	●	
	1,125	0,188	0,218	92 AU 9250	SYM	5600050870D0A	-	●	
	1,125	0,25	0,275	93 AU 2093 / N3101	LSU	12500875250-2093	-	○	
	1,125	0,25	0,275	93 AU 2093 / N3101	LSU	12500875250B-2093	-	○	
	1,125	0,25	0,281	94 AU 30000	RO	560001054000B	-	●	
	1,125	0,25	0,281	92 AU 9250	SYM	5600050860D0A	-	●	
	1,125	0,25	0,281	92 AU 9250	SYM	5600050860S0A	-	●	
	1,25	0,188	0,207	93 AU 2093 / N3101	LSU	18700875-2093	-	●	
	1,25	0,188	0,207	93 AU 2093 / N3101	LSU	18700875SQB-2093	-	○	
	1,25	0,188	0,218	92 AU 9250	RO	560001059000A	-	●	
	1,25	0,188	0,218	92 AU 9250	SYM	560005091000A	-	○	
	1,25	0,25	0,281	92 AU 9250	RO	560001058000A	-	●	
	1,25	0,25	0,281	92 AU 9250	SYM	560005090000A	-	○	
	1,25	0,25	0,281	92 AU 9250	SYM	5600050900D0A	-	●	
1,25	0,313	0,343	94 AU 30000	RO	560001057000B	-	●		
1,25	0,313	0,343	92 AU 9250	SYM	560005089000A	-	●		
1,25	0,313	0,344	93 AU 2093 / N3101	LSU	18700875312-2093	-	○		
1,25	0,313	0,344	93 AU 2093 / N3101	LSU	18700875312B-2093	-	●		
1,25	0,375	0,413	93 AU 2093 / N3101	LSU	18700875375-2093	-	○		
1,375	0,25	0,275	93 AU 2093 / N3101	LSU	25000875-2093	-	●		
1,375	0,25	0,275	93 AU 2093 / N3101	LSU	25000875SQB-2093	-	○		
1,375	0,25	0,281	92 AU 9250	SYM	560005094000A	-	○		
1,375	0,375	0,406	92 AU 9250	SYM	005092000A	-	○		
1,375	0,375	0,413	93 AU 2093 / N3101	LSU	25000875375B-2093	-	○		
1,5	0,313	0,344	93 AU 2093 / N3101	LSU	31200875-2093	-	○		
0,937	1,187	0,16	0,202	92 AU 9250	SYM	560005096ZD0A	-	○	
0,938	1,188	0,125	0,138	93 AU 2093 / N3101	LSU	12500937-2093	-	○	
	1,188	0,125	0,156	92 AU 9250	SYM	5600050970D0A	-	●	
	1,188	0,188	0,218	92 AU 9250	SYM	5600050960D0A	-	○	
	1,188	0,25	0,275	93 AU 2093 / N3101	LSU	12500937250B-2093	-	○	
	1,188	0,25	0,281	92 AU 9250	SYM	5600050950D0A	-	○	
	1,313	0,188	0,218	92 AU 9250	SYM	560005100000A	-	●	
	1,313	0,313	0,343	92 AU 9250	SYM	005098000A	-	○	
	1,438	0,25	0,275	93 AU 2093 / N3101	LSU	25000937-2093	-	●	
1,438	0,25	0,281	92 AU 9250	SYM	005103000A	-	○		
1,438	0,375	0,406	92 AU 9250	RO	560001066000A	-	●		
1	1,25	0,125	0,138	93 AU 2093 / N3101	LSU	12501000-2093	-	●	
	1,25	0,125	0,138	93 AU 2093 / N3101	LSU	12501000SQB-2093	-	○	
	1,25	0,125	0,156	92 AU 9250	RO	560001071000A	-	●	
	1,25	0,125	0,156	92 AU 9250	SYM	5600051060D0A	-	●	
	1,25	0,156	0,187	92 AU 9250	SYM	560005105BD0A	-	●	
	1,25	0,171	0,187	92 AU 9250	RO	560001069B00A	-	○	
	1,25	0,188	0,207	93 AU 2093 / N3101	LSU	12501000187B-2093	-	●	
	1,25	0,188	0,218	92 AU 9250	RO	560001070000A	-	●	

d [inch]	D [inch]	H [inch]	L [inch]	Material	Design	Part No.	PU ¹⁾	US	EU
	1,25	0,188	0,218	92 AU 9250	SYM	5600051050D0A	-	●	
	1,25	0,25	0,275	93 AU 2093 / N3101	LSU	12501000250-2093	-	○	
	1,25	0,25	0,275	93 AU 2093 / N3101	LSU	12501000250B-2093	-	●	
	1,25	0,25	0,281	94 AU 30000	D 300	560G01069000B	-	●	
	1,25	0,25	0,281	94 AU 30000	RO	560001069000B	-	●	
	1,25	0,25	0,281	92 AU 9250	SYM	5600051040D0A	-	●	
	1,313	0,218	0,24	92 AU 9250	D 300	560G01405000A	-	●	
	1,375	0,156	0,172	93 AU 2093 / N3101	LSU	156010005QB-2093	-	●	
	1,375	0,188	0,207	93 AU 2093 / N3101	LSU	15601000187B-2093	-	○	
	1,375	0,188	0,207	93 AU 2093 / N3101	LSU	18701000-2093	-	●	
	1,375	0,188	0,207	93 AU 2093 / N3101	LSU	187010005QB-2093	-	●	
	1,375	0,188	0,218	92 AU 9250	RO	560001074000A	-	○	
	1,375	0,188	0,218	92 AU 9250	SYM	560005109000A	-	●	
	1,375	0,25	0,275	93 AU 2093 / N3101	LSU	18701000250B-2093	-	●	
	1,375	0,25	0,281	92 AU 9250	D 300	560G01073000A	-	●	
	1,375	0,25	0,281	94 AU 30000	RO	560001073000B	-	●	
	1,375	0,25	0,281	92 AU 9250	SYM	560005108000A	-	●	
	1,375	0,313	0,343	92 AU 9250	D 300	560G01072000A	-	●	
1	1,375	0,313	0,343	92 AU 9250	RO	560001072000A	-	●	
	1,375	0,313	0,343	92 AU 9250	SYM	560005107000A	-	●	
	1,375	0,313	0,344	93 AU 2093 / N3101	LSU	18701000312-2093	-	○	
	1,375	0,313	0,344	93 AU 2093 / N3101	LSU	18701000312B-2093	-	●	
	1,375	0,375	0,413	93 AU 2093 / N3101	LSU	18701000375B-2093	-	●	
	1,5	0,25	0,275	93 AU 2093 / N3101	LSU	25001000-2093	-	●	
	1,5	0,25	0,275	93 AU 2093 / N3101	LSU	250010005QB-2093	-	○	
	1,5	0,25	0,281	92 AU 9250	RO	560001077000A	-	●	
	1,5	0,25	0,281	92 AU 9250	SYM	560005112000A	-	●	
	1,5	0,313	0,343	92 AU 9250	RO	560001076000A	-	○	
	1,5	0,313	0,343	92 AU 9250	SYM	560005111000A	-	○	
	1,5	0,375	0,406	94 AU 30000	D 300	560G01075000B	-	●	
	1,5	0,375	0,406	94 AU 30000	RO	560001075000B	-	●	
	1,5	0,375	0,406	92 AU 9250	SYM	560005110000A	-	●	
	1,5	0,375	0,413	93 AU 2093 / N3101	LSU	25001000375-2093	-	○	
	1,5	0,375	0,413	93 AU 2093 / N3101	LSU	25001000375B-2093	-	○	
	1,625	0,313	0,344	93 AU 2093 / N3101	LSU	31201000-2093	-	○	
	1,75	0,375	0,413	93 AU 2093 / N3101	LSU	37501000-2093	-	○	
1,062	1,312	0,125	0,138	93 AU 2093 / N3101	LSU	125010625QB-2093	-	○	
	1,437	0,188	0,207	93 AU 2093 / N3101	LSU	18701062-2093	-	○	
	1,313	0,125	0,138	93 AU 2093 / N3101	LSU	12501062-2093	-	○	
1,063	1,313	0,25	0,275	93 AU 2093 / N3101	LSU	12501062250B-2093	-	●	
	1,438	0,313	0,343	92 AU 9250	RO	560001079000A	-	●	
	0,75	0,25	0,281	92 AU 9250	RO	560001046000A	-	○	
	1,375	0,125	0,138	93 AU 2093 / N3101	LSU	12501125-2093	-	○	
	1,375	0,125	0,138	93 AU 2093 / N3101	LSU	125011255QB-2093	-	●	
	1,375	0,125	0,156	92 AU 9250	SYM	560005119AD0A	-	●	
1,125	1,375	0,187	0,218	92 AU 9250	SYM	560005119CD0A	-	○	
	1,375	0,188	0,207	93 AU 2093 / N3101	LSU	12501125187B-2093	-	●	
	1,375	0,25	0,275	93 AU 2093 / N3101	LSU	12501125250-2093	-	○	
	1,375	0,25	0,275	93 AU 2093 / N3101	LSU	12501125250B-2093	-	○	
	1,375	0,25	0,281	92 AU 9250	D 300	560G01352000A	-	○	

d [inch]	D [inch]	H [inch]	L [inch]	Material	Design	Part No.	PU ¹⁾	US	EU
1,125	1,375	0,25	0,281	92 AU 9250	SYM	5600051190D0A	-	●	
	1,5	0,188	0,207	93 AU 2093 / N3101	LSU	18701125-2093	-	●	
	1,5	0,188	0,218	92 AU 9250	SYM	560005120C00A	-	●	
	1,5	0,25	0,275	93 AU 2093 / N3101	LSU	18701125250B-2093	-	●	
	1,5	0,25	0,281	92 AU 9250	D 300	560G01086000A	-	●	
	1,5	0,25	0,281	92 AU 9250	RO	560001086000A	-	○	
	1,5	0,25	0,281	92 AU 9250	SYM	560005121000A	-	●	
	1,5	0,25	0,281	92 AU 9250	SYM	560005121Y00A	-	○	
	1,5	0,313	0,343	94 AU 30000	D 300	560G01085000B	-	●	
	1,5	0,313	0,343	94 AU 30000	RO	560001085000B	-	●	
	1,5	0,313	0,343	92 AU 9250	SYM	560005120000A	-	●	
	1,5	0,313	0,344	93 AU 2093 / N3101	LSU	18701125312-2093	-	●	
	1,5	0,313	0,344	93 AU 2093 / N3101	LSU	18701125312B-2093	-	●	
	1,5	0,375	0,406	92 AU 9250	RO	560001084000A	-	●	
	1,5	0,375	0,413	93 AU 2093 / N3101	LSU	18701125375B-2093	-	○	
	1,625	0,25	0,275	93 AU 2093 / N3101	LSU	25001125-2093	-	○	
	1,625	0,25	0,281	92 AU 9250	RO	560001089000A	-	○	
	1,625	0,25	0,281	92 AU 9250	SYM	560005124000A	-	○	
	1,625	0,281	0,312	92 AU 9250	SYM	560005123F00A	-	○	
	1,625	0,313	0,343	92 AU 9250	SYM	560005123000A	-	○	
1,625	0,375	0,406	94 AU 30000	RO	560001087000B	-	●		
1,625	0,375	0,406	92 AU 9250	SYM	005122000A	-	●		
1,625	0,375	0,413	93 AU 2093 / N3101	LSU	25001125375B-2093	-	○		
1,75	0,313	0,344	93 AU 2093 / N3101	LSU	31201125-2093	-	○		
1,75	0,313	0,344	93 AU 2093 / N3101	LSU	31201125SQB-2093	-	○		
1,75	0,375	0,413	93 AU 2093 / N3101	LSU	31201125375B-2093	-	○		
1,187	1,437	0,188	0,207	93 AU 2093 / N3101	LSU	12501187187B-2093	-	○	
	1,562	0,156	0,172	93 AU 2093 / N3101	LSU	15601187-2093	-	●	
	1,562	0,188	0,207	93 AU 2093 / N3101	LSU	18701187-2093	-	●	
	1,562	0,25	0,275	93 AU 2093 / N3101	LSU	18701187250B-2093	-	○	
	1,562	0,313	0,344	93 AU 2093 / N3101	LSU	18701187312B-2093	-	○	
	1,687	0,25	0,275	93 AU 2093 / N3101	LSU	25001187SQB-2093	-	○	
1,188	1,438	0,125	0,138	93 AU 2093 / N3101	LSU	12501187-2093	-	○	
	1,438	0,25	0,275	93 AU 2093 / N3101	LSU	12501187250B-2093	-	○	
	1,563	0,25	0,281	94 AU 30000	RO	560001092000B	-	●	
	1,563	0,313	0,343	92 AU 9250	SYM	560005127000A	-	○	
	1,688	0,25	0,275	93 AU 2093 / N3101	LSU	25001187-2093	-	○	
	1,688	0,25	0,281	92 AU 9250	SYM	5600051310D0A	-	●	
	1,688	0,313	0,343	92 AU 9250	SYM	560005130000A	-	●	
	1,688	0,375	0,413	93 AU 2093 / N3101	LSU	25001187375B-2093	-	○	
1,25	1,5	0,125	0,138	93 AU 2093 / N3101	LSU	12501250-2093	-	○	
	1,5	0,125	0,138	93 AU 2093 / N3101	LSU	12501250SQB-2093	-	○	
	1,5	0,135	0,156	92 AU 9250	SYM	560005132AD0A	-	●	
	1,5	0,156	0,188	92 AU 9250	SYM	560005132BD0A	-	●	
	1,5	0,187	0,218	92 AU 9250	SYM	560005132CD0A	-	●	
	1,5	0,188	0,207	93 AU 2093 / N3101	LSU	12501250187-2093	-	○	
	1,5	0,188	0,207	93 AU 2093 / N3101	LSU	12501250187B-2093	-	●	
	1,5	0,25	0,275	93 AU 2093 / N3101	LSU	12501250250B-2093	-	○	
	1,5	0,25	0,281	94 AU 30000	D 300	560G01093000B	-	●	
	1,5	0,25	0,281	92 AU 9250	SYM	5600051320D0A	-	●	

d [inch]	D [inch]	H [inch]	L [inch]	Material	Design	Part No.	PU ¹⁾	US	EU
	1,625	0,187	0,218	92 AU 9250	SYM	560005133C00A	-	○	
	1,625	0,188	0,207	93 AU 2093 / N3101	LSU	18701250-2093	-	●	
	1,625	0,188	0,207	93 AU 2093 / N3101	LSU	18701250SQB-2093	-	○	
	1,625	0,25	0,275	93 AU 2093 / N3101	LSU	18701250250B-2093	-	○	
	1,625	0,25	0,281	92 AU 9250	D 300	560G01096000A	-	●	
	1,625	0,25	0,281	92 AU 9250	RO	560001096000A	-	●	
	1,625	0,25	0,281	92 AU 9250	SYM	560005134000A	-	●	
	1,625	0,313	0,343	94 AU 30000	D 300	560G01095000B	-	●	
	1,625	0,313	0,343	94 AU 30000	RO	560001095000B	-	●	
	1,625	0,313	0,343	92 AU 9250	SYM	560005133000A	-	●	
	1,625	0,313	0,344	93 AU 2093 / N3101	LSU	18701250312-2093	-	○	
	1,625	0,313	0,344	93 AU 2093 / N3101	LSU	18701250312B-2093	-	●	
	1,625	0,375	0,406	92 AU 9250	D 300	560G01094000A	-	●	
	1,625	0,375	0,406	92 AU 9250	RO	560001094000A	-	●	
	1,625	0,375	0,413	93 AU 2093 / N3101	LSU	18701250375B-2093	-	○	
	1,75	0,25	0,275	93 AU 2093 / N3101	LSU	25001250-2093	-	●	
	1,75	0,25	0,275	93 AU 2093 / N3101	LSU	25001250SQB-2093	-	○	
	1,75	0,25	0,281	94 AU 30000	RO	560001099000B	-	●	
1,25	1,75	0,25	0,281	92 AU 9250	SYM	560005137000A	-	●	
	1,75	0,313	0,343	92 AU 9250	RO	560001098000A	-	●	
	1,75	0,313	0,343	92 AU 9250	SYM	560005136000A	-	●	
	1,75	0,375	0,406	94 AU 30000	D 300	560G01097000B	-	●	
	1,75	0,375	0,406	92 AU 9250	RO	560001097000A	-	●	
	1,75	0,375	0,406	92 AU 9250	SYM	560005135000A	-	●	
	1,75	0,375	0,413	93 AU 2093 / N3101	LSU	25001250375B-2093	-	○	
	1,819	0,122	0,14	92 AU 9250 / PA	HBV	560501212000A	-	●	
	1,875	0,312	0,343	92 AU 9250	SYM	560005138G00A	-	●	
	1,875	0,375	0,406	92 AU 9250	SYM	560005140000A	-	○	
	1,875	0,375	0,413	93 AU 2093 / N3101	LSU	31201250375B-2093	-	○	
	1,875	0,438	0,468	92 AU 9250	RO	560001101000A	-	○	
	1,875	0,5	0,531	92 AU 9250	SYM	560005138000A	-	○	
	2	0,375	0,406	92 AU 9250	SYM	005143000A	-	●	
	2	0,375	0,413	93 AU 2093 / N3101	LSU	37501250-2093	-	○	
	2	0,375	0,413	93 AU 2093 / N3101	LSU	37501250SQB-2093	-	○	
	2	0,5	0,531	92 AU 9250	SYM	005141000A	-	●	
	2	0,625	0,688	93 AU 2093 / N3101	LSU	37501250625-2093	-	○	
	2	0,625	0,688	93 AU 2093 / N3101	LSU	37501250625B-2093	-	○	
1,312	1,562	0,188	0,207	93 AU 2093 / N3101	LSU	12501312187B-2093	-	○	
	1,562	0,25	0,275	93 AU 2093 / N3101	LSU	12501312250B-2093	-	○	
	1,563	0,125	0,138	93 AU 2093 / N3101	LSU	12501312-2093	-	○	
	1,563	0,25	0,281	92 AU 9250	SYM	0051440D0A	-	○	
	1,688	0,313	0,343	92 AU 9250	SYM	005145000A	-	○	
1,313	1,688	0,313	0,344	93 AU 2093 / N3101	LSU	18701312312B-2093	-	○	
	1,813	0,375	0,406	92 AU 9250	RO	001103000A	-	○	
	1,813	0,375	0,406	92 AU 9250	SYM	560005146000A	-	○	
	1,813	0,375	0,413	93 AU 2093 / N3101	LSU	25001312375B-2093	-	○	
	1,938	0,313	0,344	93 AU 2093 / N3101	LSU	31201312-2093	-	○	
1,375	1,625	0,125	0,138	93 AU 2093 / N3101	LSU	12501375-2093	-	○	
	1,625	0,125	0,138	93 AU 2093 / N3101	LSU	12501375SQB-2093	-	○	
	1,625	0,188	0,207	93 AU 2093 / N3101	LSU	12501375187B-2093	-	●	

d [inch]	D [inch]	H [inch]	L [inch]	Material	Design	Part No.	PU ¹⁾	US	EU
1,375	1,625	0,25	0,275	93 AU 2093 / N3101	LSU	12501375250-2093	-	●	
	1,625	0,25	0,275	93 AU 2093 / N3101	LSU	12501375250B-2093	-	○	
	1,625	0,25	0,281	92 AU 9250	SYM	5600051510D0A	-	○	
	1,625	0,25	0,281	92 AU 9250	SYM	5600051510S0A	-	●	
	1,688	0,219	0,24	92 AU 9250	D 300	560G01425000A	-	●	
	1,688	0,313	0,343	92 AU 9250	D 300	560G01410000A	-	○	
	1,75	0,156	0,172	93 AU 2093 / N3101	LSU	15601375-2093	-	●	
	1,75	0,156	0,172	93 AU 2093 / N3101	LSU	15601375SQB-2093	-	○	
	1,75	0,188	0,207	93 AU 2093 / N3101	LSU	18701375-2093	-	○	
	1,75	0,188	0,207	93 AU 2093 / N3101	LSU	18701375SQB-2093	-	○	
	1,75	0,25	0,275	93 AU 2093 / N3101	LSU	18701375250B-2093	-	○	
	1,75	0,25	0,281	92 AU 9250	SYM	560005152E00A	-	●	
	1,75	0,313	0,343	94 AU 30000	D 300	560G01106000B	-	●	
	1,75	0,313	0,343	94 AU 30000	RO	560001106000B	-	●	
	1,75	0,313	0,343	92 AU 9250	SYM	560005152000A	-	●	
	1,75	0,313	0,344	93 AU 2093 / N3101	LSU	18701375312-2093	-	○	
	1,75	0,313	0,344	93 AU 2093 / N3101	LSU	18701375312B-2093	-	○	
	1,75	0,375	0,406	92 AU 9250	RO	560001105000A	-	○	
	1,75	0,375	0,413	93 AU 2093 / N3101	LSU	18701375375B-2093	-	○	
	1,875	0,25	0,275	93 AU 2093 / N3101	LSU	25001375-2093	-	●	
	1,875	0,25	0,275	93 AU 2093 / N3101	LSU	25001375SQB-2093	-	○	
	1,875	0,25	0,281	92 AU 9250	SYM	560005153E00A	-	●	
	1,875	0,313	0,343	92 AU 9250	RO	560001108000A	-	○	
	1,875	0,313	0,343	92 AU 9250	SYM	560005154000A	-	○	
	1,875	0,375	0,406	94 AU 30000	D 300	560G01107000B	-	●	
	1,875	0,375	0,406	92 AU 9250	RO	560001107000A	-	●	
	1,875	0,375	0,406	92 AU 9250	SYM	560005153000A	-	●	
	1,875	0,375	0,413	93 AU 2093 / N3101	LSU	25001375375-2093	-	○	
	1,875	0,375	0,413	93 AU 2093 / N3101	LSU	25001375375B-2093	-	●	
	2	0,312	0,343	92 AU 9250	SYM	560005155G00A	-	●	
	2	0,313	0,344	93 AU 2093 / N3101	LSU	31201375-2093	-	●	
	2	0,375	0,406	92 AU 9250	RO	560001111000A	-	●	
2	0,375	0,406	92 AU 9250	SYM	560005157000A	-	●		
2	0,375	0,413	93 AU 2093 / N3101	LSU	31201375375B-2093	-	○		
1,437	1,812	0,25	0,281	92 AU 9250	SYM	005159E00A	-	○	
1,438	1,813	0,313	0,343	92 AU 9250	SYM	005159000A	-	○	
	1,813	0,313	0,344	93 AU 2093 / N3101	LSU	18701437312B-2093	-	○	
1,5	1,25	0,25	0,281	94 AU 30000	RO	560001093000B	-	●	
	1,75	0,125	0,138	93 AU 2093 / N3101	LSU	12501500-2093	-	●	
	1,75	0,125	0,138	93 AU 2093 / N3101	LSU	12501500SQB-2093	-	○	
	1,75	0,188	0,207	93 AU 2093 / N3101	LSU	12501500187B-2093	-	○	
	1,75	0,25	0,275	93 AU 2093 / N3101	LSU	12501500250-2093	-	○	
	1,75	0,25	0,275	93 AU 2093 / N3101	LSU	12501500250B-2093	-	○	
	1,75	0,25	0,281	92 AU 9250	SYM	5600051630D0A	-	●	
	1,875	0,188	0,207	93 AU 2093 / N3101	LSU	18701500-2093	-	○	
	1,875	0,188	0,207	93 AU 2093 / N3101	LSU	18701500SQB-2093	-	●	
	1,875	0,188	0,218	92 AU 9250	SYM	560005164C00A	-	●	
	1,875	0,25	0,275	93 AU 2093 / N3101	LSU	18701500250B-2093	-	●	
	1,875	0,25	0,281	92 AU 9250	D 300	560G01114000A	-	●	
	1,875	0,25	0,281	94 AU 30000	RO	560001114000B	-	●	

d [inch]	D [inch]	H [inch]	L [inch]	Material	Design	Part No.	PU ¹⁾	US	EU
	1,875	0,25	0,281	92 AU 9250	SYM	560005164E00A	-	●	
	1,875	0,275	0,303	93 AU 2093 / N3101	LSU	18701500275B-2093	-	○	
	1,875	0,313	0,343	92 AU 9250	D 300	560G01113000A	-	●	
	1,875	0,313	0,343	92 AU 9250	RO	560001113000A	-	●	
	1,875	0,313	0,343	92 AU 9250	SYM	560005165000A	-	●	
	1,875	0,313	0,344	93 AU 2093 / N3101	LSU	15601500312B-2093	-	○	
	1,875	0,313	0,344	93 AU 2093 / N3101	LSU	18701500312-2093	-	○	
	1,875	0,313	0,344	93 AU 2093 / N3101	LSU	18701500312B-2093	-	○	
	1,875	0,375	0,406	94 AU 30000	D 300	560G01112000B	-	●	
	1,875	0,375	0,406	92 AU 9250	RO	560001112000A	-	●	
	1,875	0,375	0,406	92 AU 9250	SYM	560005164000A	-	●	
	1,875	0,375	0,413	93 AU 2093 / N3101	LSU	18701500375B-2093	-	○	
	2	0,25	0,275	93 AU 2093 / N3101	LSU	25001500-2093	-	○	
	2	0,25	0,275	93 AU 2093 / N3101	LSU	25001500SQB-2093	-	○	
	2	0,25	0,281	94 AU 30000	D 300	560G01115000B	-	●	
	2	0,25	0,281	92 AU 9250	SYM	560005167E00A	-	●	
1,5	2	0,313	0,343	92 AU 9250	RO	560001116000A	-	●	
	2	0,313	0,343	92 AU 9250	SYM	560005167000A	-	●	
	2	0,375	0,406	94 AU 30000	RO	560001115000B	-	●	
	2	0,375	0,406	92 AU 9250	SYM	560005166000A	-	●	
	2	0,375	0,413	93 AU 2093 / N3101	LSU	25001500375-2093	-	○	
	2	0,375	0,413	93 AU 2093 / N3101	LSU	25001500375B-2093	-	○	
	2	0,5	0,55	93 AU 2093 / N3101	LSU	25001500500B-2093	-	○	
	2,067	0,122	0,14	92 AU 9250 / PA	HBY	560501213000A	-	●	
	2,125	0,375	0,406	92 AU 9250	SYM	560005170000A	-	○	
	2,125	0,375	0,413	93 AU 2093 / N3101	LSU	31201500375B-2093	-	●	
	2,125	0,438	0,469	92 AU 9250	SYM	560005169000A	-	○	
	2,125	0,5	0,531	92 AU 9250	SYM	560005168000A	-	○	
	2,125	0,5	0,55	93 AU 2093 / N3101	LSU	31201500500B-2093	-	○	
	2,25	0,375	0,406	92 AU 9250	SYM	560005173000A	-	○	
	2,25	0,375	0,413	93 AU 2093 / N3101	LSU	37501500-2093	-	○	
	2,25	0,5	0,531	92 AU 9250	SYM	560005171000A	-	○	
	2,5	0,5	0,55	93 AU 2093 / N3101	LSU	50001500-2093	-	○	
1,563	1,938	0,188	0,207	93 AU 2093 / N3101	LSU	18701562-2093	-	○	
	1,875	0,125	0,138	93 AU 2093 / N3101	LSU	12501625-2093	-	○	
	2	0,188	0,207	93 AU 2093 / N3101	LSU	18701625-2093	-	●	
	2	0,188	0,207	93 AU 2093 / N3101	LSU	18701625SQB-2093	-	●	
	2	0,25	0,275	93 AU 2093 / N3101	LSU	18701625250B-2093	-	●	
	2	0,25	0,281	92 AU 9250	SYM	560005174E00A	-	●	
	2	0,265	0,281	92 AU 9250	RO	560001120E00A	-	○	
	2	0,313	0,343	94 AU 30000	RO	560001121000B	-	●	
1,625	2	0,313	0,343	92 AU 9250	SYM	560005175000A	-	●	
	2	0,313	0,344	93 AU 2093 / N3101	LSU	18701625312-2093	-	○	
	2	0,313	0,344	93 AU 2093 / N3101	LSU	18701625312B-2093	-	○	
	2	0,375	0,406	92 AU 9250	D 300	560G01120000A	-	●	
	2	0,375	0,406	92 AU 9250	RO	560001120000A	-	●	
	2	0,375	0,406	92 AU 9250	SYM	560005174000A	-	●	
	2	0,375	0,413	93 AU 2093 / N3101	LSU	18701625375-2093	-	●	
	2	0,375	0,413	93 AU 2093 / N3101	LSU	18701625375B-2093	-	○	
	2,125	0,313	0,343	92 AU 9250	RO	560001123000A	-	○	

d [inch]	D [inch]	H [inch]	L [inch]	Material	Design	Part No.	PU ¹⁾	US	EU
1,625	2,125	0,375	0,406	94 AU 30000	RO	560001122000B	-	●	
	2,125	0,375	0,406	92 AU 9250	SYM	560005176000A	-	○	
	2,25	0,312	0,343	92 AU 9250	SYM	005180G00A	-	○	
	2,25	0,313	0,344	93 AU 2093 / N3101	LSU	31201625-2093	-	○	
	2,25	0,375	0,406	92 AU 9250	SYM	560005180000A	-	●	
	2,25	0,375	0,413	93 AU 2093 / N3101	LSU	31201625375B-2093	-	○	
	2,375	0,375	0,406	92 AU 9250	SYM	005183000A	-	○	
	2,375	0,375	0,413	93 AU 2093 / N3101	LSU	37501625-2093	-	○	
	2,375	0,5	0,531	92 AU 9250	SYM	005182000A	-	○	
	2,375	0,625	0,688	93 AU 2093 / N3101	LSU	37501625625B-2093	-	○	
1,688	2,063	0,188	0,207	93 AU 2093 / N3101	LSU	18701687-2093	-	○	
1,689	2,187	0,312	0,33	92 AU 9250	RO	560001404000A	-	○	
1,75	2	0,125	0,138	93 AU 2093 / N3101	LSU	12501750SQB-2093	-	○	
	2	0,188	0,207	93 AU 2093 / N3101	LSU	12501750187B-2093	-	○	
	2	0,25	0,275	93 AU 2093 / N3101	LSU	12501750250B-2093	-	○	
	2,125	0,188	0,207	93 AU 2093 / N3101	LSU	18701750-2093	-	○	
	2,125	0,188	0,207	93 AU 2093 / N3101	LSU	18701750SQB-2093	-	●	
	2,125	0,188	0,218	92 AU 9250	SYM	560005184CD0A	-	○	
	2,125	0,23	0,253	93 AU 2093 / N3101	LSU	18701750230B-2093	-	○	
	2,125	0,25	0,275	93 AU 2093 / N3101	LSU	18701750250-2093	-	○	
	2,125	0,25	0,275	93 AU 2093 / N3101	LSU	18701750250B-2093	-	○	
	2,125	0,25	0,281	92 AU 9250	D 300	560G01127E00A	-	○	
	2,125	0,25	0,281	92 AU 9250	SYM	560005184E00A	-	●	
	2,125	0,265	0,281	94 AU 30000	RO	560001127E00B	-	●	
	2,125	0,275	0,303	93 AU 2093 / N3101	LSU	18701750275B-2093	-	○	
	2,125	0,313	0,343	94 AU 30000	D 300	560G01128000B	-	●	
	2,125	0,313	0,343	94 AU 30000	RO	560001128000B	-	●	
	2,125	0,313	0,343	92 AU 9250	SYM	560005185000A	-	○	
	2,125	0,313	0,344	93 AU 2093 / N3101	LSU	18701750312-2093	-	○	
	2,125	0,313	0,344	93 AU 2093 / N3101	LSU	18701750312B-2093	-	●	
	2,125	0,375	0,406	94 AU 30000	D 300	560G01127000B	-	●	
	2,125	0,375	0,406	92 AU 9250	RO	560001127000A	-	●	
	2,125	0,375	0,406	92 AU 9250	SYM	560005184000A	-	●	
	2,125	0,375	0,413	93 AU 2093 / N3101	LSU	18701750375-2093	-	●	
	2,125	0,375	0,413	93 AU 2093 / N3101	LSU	18701750375B-2093	-	○	
	2,25	0,25	0,275	93 AU 2093 / N3101	LSU	25001750-2093	-	○	
	2,25	0,25	0,281	92 AU 9250	SYM	560005186E00A	-	●	
	2,25	0,265	0,281	92 AU 9250	RO	560001129E00A	-	○	
	2,25	0,312	0,343	92 AU 9250	SYM	560005187000A	-	○	
	2,25	0,313	0,343	92 AU 9250	D 300	560G01130000A	-	●	
	2,25	0,313	0,343	92 AU 9250	RO	560001130000A	-	●	
	2,25	0,313	0,344	93 AU 2093 / N3101	LSU	25001750312B-2093	-	○	
	2,25	0,375	0,406	94 AU 30000	D 300	560G01129000B	-	●	
	2,25	0,375	0,406	94 AU 30000	RO	560001129000B	-	●	
	2,25	0,375	0,406	92 AU 9250	SYM	560005186000A	-	●	
	2,25	0,375	0,413	93 AU 2093 / N3101	LSU	25001750375-2093	-	●	
	2,25	0,375	0,413	93 AU 2093 / N3101	LSU	25001750375B-2093	-	○	
	2,319	0,122	0,14	92 AU 9250 / PA	HBY	560501214000A	-	●	
2,375	0,312	0,343	92 AU 9250	SYM	560005188G00A	-	○		
2,375	0,313	0,344	93 AU 2093 / N3101	LSU	31201750-2093	-	○		

d [inch]	D [inch]	H [inch]	L [inch]	Material	Design	Part No.	PU ¹⁾	US	EU
1,75	2,375	0,375	0,406	92 AU 9250	D 300	560G01133000A	-	●	
	2,375	0,375	0,406	94 AU 30000	RO	560001133000B	-	●	
	2,375	0,375	0,406	92 AU 9250	SYM	005190000A	-	●	
	2,375	0,5	0,531	92 AU 9250	D 300	560G01131000A	-	●	
	2,375	0,5	0,531	92 AU 9250	RO	560001131000A	-	●	
	2,375	0,5	0,531	92 AU 9250	SYM	560005188000A	-	●	
	2,5	0,375	0,406	92 AU 9250	SYM	005193000A	-	○	
	2,5	0,375	0,413	93 AU 2093 / N3101	LSU	37501750-2093	-	○	
	2,5	0,5	0,531	92 AU 9250	SYM	005192000A	-	●	
	2,5	0,5	0,55	93 AU 2093 / N3101	LSU	37501750500B-2093	-	○	
	2,5	0,593	0,624	92 AU 9250	SYM	005191QB0A	-	○	
	2,5	0,625	0,656	92 AU 9250	SYM	005191000A	-	●	
	2,5	0,625	0,688	93 AU 2093 / N3101	LSU	37501750625B-2093	-	○	
	2,75	0,5	0,55	93 AU 2093 / N3101	LSU	50001750-2093	-	○	
1,875	2,125	0,125	0,138	93 AU 2093 / N3101	LSU	12501875-2093	-	○	
	2,25	0,188	0,207	93 AU 2093 / N3101	LSU	18701875-2093	-	●	
	2,25	0,188	0,218	92 AU 9250	SYM	560005194C00A	-	●	
	2,25	0,25	0,275	93 AU 2093 / N3101	LSU	18701875250B-2093	-	○	
	2,25	0,313	0,343	94 AU 30000	RO	560001135000B	-	●	
	2,25	0,313	0,343	92 AU 9250	SYM	560005195000A	-	●	
	2,25	0,313	0,344	93 AU 2093 / N3101	LSU	18701875312B-2093	-	○	
	2,25	0,375	0,406	92 AU 9250	D 300	560G01134000A	-	●	
	2,25	0,375	0,406	92 AU 9250	RO	560001134000A	-	○	
	2,25	0,375	0,406	92 AU 9250	SYM	560005194000A	-	●	
	2,25	0,375	0,413	93 AU 2093 / N3101	LSU	18701875375B-2093	-	○	
	2,375	0,313	0,343	92 AU 9250	RO	560001137000A	-	○	
	2,375	0,375	0,413	93 AU 2093 / N3101	LSU	25001875375B-2093	-	○	
	2,5	0,312	0,343	92 AU 9250	SYM	560005196G00A	-	●	
	2,5	0,313	0,344	93 AU 2093 / N3101	LSU	31201875-2093	-	○	
	2,5	0,375	0,406	92 AU 9250	SYM	560005198000A	-	●	
	2,5	0,375	0,413	93 AU 2093 / N3101	LSU	31201875375B-2093	-	○	
	2,5	0,5	0,531	92 AU 9250	SYM	560005196000A	-	●	
	2,5	0,5	0,55	93 AU 2093 / N3101	LSU	31201875500-2093	-	○	
	2,625	0,375	0,413	93 AU 2093 / N3101	LSU	37501875-2093	-	○	
2,625	0,625	0,688	93 AU 2093 / N3101	LSU	37501875625-2093	-	●		
2,875	0,625	0,656	92 AU 9250	SYM	5600055230B0A	-	●		
1,938	2,563	0,313	0,344	93 AU 2093 / N3101	LSU	31201937-2093	-	○	
2	2,25	0,125	0,138	93 AU 2093 / N3101	LSU	12502000-2093	-	○	
	2,25	0,25	0,275	93 AU 2093 / N3101	LSU	12502000250B-2093	-	○	
	2,375	0,188	0,207	93 AU 2093 / N3101	LSU	18702000-2093	-	●	
	2,375	0,188	0,207	93 AU 2093 / N3101	LSU	18702000SQB-2093	-	●	
	2,375	0,25	0,275	93 AU 2093 / N3101	LSU	18702000250B-2093	-	●	
	2,375	0,25	0,281	92 AU 9250	D 300	560G01412000A	-	●	
	2,375	0,25	0,281	92 AU 9250	SYM	560005202E00A	-	●	
	2,375	0,265	0,281	92 AU 9250	RO	560001141E00A	-	●	
	2,375	0,275	0,303	93 AU 2093 / N3101	LSU	18702000275B-2093	-	○	
	2,375	0,296	0,309	92 AU 9250	RO	560001142G00A	-	○	
	2,375	0,313	0,343	92 AU 9250	D 300	560G01142000A	-	●	
	2,375	0,313	0,343	92 AU 9250	RO	560001142000A	-	●	
	2,375	0,313	0,343	92 AU 9250	SYM	560005203000A	-	●	

d [inch]	D [inch]	H [inch]	L [inch]	Material	Design	Part No.	PU ¹⁾	US	EU
	2,375	0,313	0,344	93 AU 2093 / N3101	LSU	18702000312B-2093	-	○	
	2,375	0,375	0,406	94 AU 30000	D 300	560G01141000B	-	●	
	2,375	0,375	0,406	94 AU 30000	RO	560001141000B	-	●	
	2,375	0,375	0,406	92 AU 9250	SYM	560005202000A	-	●	
	2,375	0,375	0,413	93 AU 2093 / N3101	LSU	18702000375-2093	-	○	
	2,375	0,375	0,413	93 AU 2093 / N3101	LSU	18702000375B-2093	-	●	
	2,375	0,375	0,413	93 AU 2093 / N3101	LSU	18702000375L-2093	-	○	
	2,5	0,25	0,275	93 AU 2093 / N3101	LSU	25002000-2093	-	○	
	2,5	0,25	0,275	93 AU 2093 / N3101	LSU	25002000SQB-2093	-	○	
	2,5	0,25	0,281	92 AU 9250	RO	560001143E00A	-	●	
	2,5	0,25	0,281	92 AU 9250	SYM	560005204E00A	-	●	
	2,5	0,313	0,343	92 AU 9250	RO	560001144000A	-	●	
	2,5	0,313	0,344	93 AU 2093 / N3101	LSU	25002000312B-2093	-	●	
	2,5	0,375	0,406	94 AU 30000	D 300	560G01143000B	-	●	
	2,5	0,375	0,406	94 AU 30000	RO	560001143000B	-	●	
	2,5	0,375	0,406	92 AU 9250	SYM	560005204000A	-	●	
	2,5	0,375	0,413	93 AU 2093 / N3101	LSU	25002000375-2093	-	○	
	2,5	0,375	0,413	93 AU 2093 / N3101	LSU	25002000375B-2093	-	●	
	2,5	0,5	0,55	93 AU 2093 / N3101	LSU	25002000500B-2093	-	○	
	2,567	0,122	0,14	94 AU 30000	HBV	560501215000B	-	●	
	2,625	0,25	0,281	92 AU 9250	SYM	005206E00A	-	○	
	2,625	0,312	0,343	92 AU 9250	SYM	005206G00A	-	●	
2	2,625	0,313	0,344	93 AU 2093 / N3101	LSU	31202000-2093	-	●	
	2,625	0,375	0,406	92 AU 9250	RO	560001147000A	-	●	
	2,625	0,375	0,406	92 AU 9250	SYM	005208000A	-	●	
	2,625	0,375	0,413	93 AU 2093 / N3101	LSU	31202000375B-2093	-	○	
	2,625	0,437	0,481	93 AU 2093 / N3101	LSU	31202000437B-2093	-	○	
	2,625	0,5	0,531	92 AU 9250	D 300	560G01145000A	-	●	
	2,625	0,5	0,531	92 AU 9250	RO	560001145000A	-	●	
	2,625	0,5	0,531	92 AU 9250	SYM	005206000A	-	○	
	2,625	0,5	0,55	93 AU 2093 / N3101	LSU	31202000500-2093	-	○	
	2,625	0,5	0,55	93 AU 2093 / N3101	LSU	31202000500B-2093	-	○	
	2,75	0,375	0,406	94 AU 30000	RO	560001150000B	-	●	
	2,75	0,375	0,406	92 AU 9250	SYM	560005211000A	-	●	
	2,75	0,375	0,413	93 AU 2093 / N3101	LSU	37502000-2093	-	○	
	2,75	0,375	0,413	93 AU 2093 / N3101	LSU	37502000SQB-2093	-	●	
	2,75	0,5	0,531	92 AU 9250	RO	560001149000A	-	●	
	2,75	0,5	0,531	92 AU 9250	SYM	560005210000A	-	●	
	2,75	0,5	0,55	93 AU 2093 / N3101	LSU	37502000500-2093	-	○	
	2,75	0,5	0,55	93 AU 2093 / N3101	LSU	37502000500B-2093	-	○	
	2,75	0,563	0,618	93 AU 2093 / N3101	LSU	37502000562B-2093	-	○	
	2,75	0,625	0,656	92 AU 9250	RO	560001148000A	-	○	
	2,75	0,625	0,656	92 AU 9250	SYM	560005209000A	-	○	
	2,75	0,625	0,688	93 AU 2093 / N3101	LSU	37502000625B-2093	-	○	
	3	0,5	0,55	93 AU 2093 / N3101	LSU	50002000-2093	-	○	
	2,375	0,25	0,275	93 AU 2093 / N3101	LSU	12502125250B-2093	-	●	
2,125	2,5	0,188	0,207	93 AU 2093 / N3101	LSU	18702125-2093	-	●	
	2,5	0,188	0,207	93 AU 2093 / N3101	LSU	18702125SQB-2093	-	○	
	2,5	0,188	0,218	92 AU 9250	SYM	560005212C00A	-	●	
	2,5	0,25	0,275	93 AU 2093 / N3101	LSU	18702125250-2093	-	○	

d [inch]	D [inch]	H [inch]	L [inch]	Material	Design	Part No.	PU ¹⁾	US	EU
2,125	2,5	0,25	0,275	93 AU 2093 / N3101	LSU	18702125250B-2093	-	○	
	2,5	0,25	0,281	92 AU 9250	SYM	560005212E00A	-	●	
	2,5	0,313	0,343	92 AU 9250	SYM	560005213000A	-	●	
	2,5	0,313	0,344	93 AU 2093 / N3101	LSU	18702125312B-2093	-	●	
	2,5	0,37	0,406	92 AU 9250	D 300	560G01151000A	-	○	
	2,5	0,375	0,406	92 AU 9250	SYM	560005212000A	-	●	
	2,5	0,375	0,413	93 AU 2093 / N3101	LSU	18702125375-2093	-	○	
	2,5	0,375	0,413	93 AU 2093 / N3101	LSU	18702125375B-2093	-	○	
	2,625	0,188	0,218	92 AU 9250	SYM	560005219C00A	-	○	
	2,625	0,25	0,275	93 AU 2093 / N3101	LSU	25002125-2093	-	○	
	2,625	0,25	0,281	92 AU 9250	SYM	560005214E00A	-	○	
	2,625	0,313	0,343	92 AU 9250	RO	560001154000A	-	○	
	2,625	0,375	0,406	92 AU 9250	RO	560001153000A	-	●	
	2,625	0,375	0,406	92 AU 9250	SYM	560005214000A	-	●	
	2,625	0,375	0,413	93 AU 2093 / N3101	LSU	25002125375B-2093	-	○	
	2,625	0,39	0,406	92 AU 9250	D 300	560G01153000A	-	○	
	2,75	0,312	0,343	92 AU 9250	SYM	560005216G00A	-	○	
	2,75	0,313	0,344	93 AU 2093 / N3101	LSU	31202125-2093	-	○	
	2,75	0,375	0,406	92 AU 9250	SYM	560005218000A	-	●	
	2,75	0,5	0,531	92 AU 9250	SYM	560005216000A	-	○	
2,875	0,375	0,413	93 AU 2093 / N3101	LSU	37502125-2093	-	○		
2,875	0,625	0,688	93 AU 2093 / N3101	LSU	37502125625B-2093	-	○		
2,25	2,5	0,125	0,138	93 AU 2093 / N3101	LSU	12502250-2093	-	○	
	2,5	0,25	0,275	93 AU 2093 / N3101	LSU	12502250250B-2093	-	○	
	2,625	0,188	0,207	93 AU 2093 / N3101	LSU	18702250-2093	-	○	
	2,625	0,188	0,207	93 AU 2093 / N3101	LSU	18702250SQB-2093	-	○	
	2,625	0,268	0,299	92 AU 9250	D 300	560G01156Z00A	-	●	
	2,625	0,313	0,343	92 AU 9250	SYM	560005220000A	-	●	
	2,625	0,313	0,344	93 AU 2093 / N3101	LSU	18702250312B-2093	-	○	
	2,625	0,375	0,406	94 AU 30000	D 300	560G01155000B	-	●	
	2,625	0,375	0,406	92 AU 9250	RO	001155000A	-	●	
	2,625	0,375	0,406	92 AU 9250	SYM	560005219000A	-	●	
	2,75	0,25	0,275	93 AU 2093 / N3101	LSU	25002250-2093	-	○	
	2,75	0,25	0,275	93 AU 2093 / N3101	LSU	25002250SQB-2093	-	○	
	2,75	0,313	0,343	92 AU 9250	RO	560001158000A	-	○	
	2,75	0,313	0,343	92 AU 9250	SYM	005222000A	-	●	
	2,75	0,375	0,406	94 AU 30000	D 300	560G01157000B	-	●	
	2,75	0,375	0,406	94 AU 30000	RO	560001157000B	-	●	
	2,75	0,375	0,406	92 AU 9250	SYM	560005221000A	-	●	
	2,75	0,375	0,413	93 AU 2093 / N3101	LSU	25002250375-2093	-	○	
	2,875	0,25	0,281	92 AU 9250	SYM	560005223E00A	-	○	
	2,875	0,312	0,343	92 AU 9250	SYM	560005223G00A	-	○	
	2,875	0,375	0,406	92 AU 9250	RO	560001161000A	-	●	
	2,875	0,375	0,406	92 AU 9250	SYM	560005225000A	-	●	
	2,875	0,5	0,531	92 AU 9250	RO	560001159000A	-	●	
	2,875	0,5	0,531	92 AU 9250	SYM	560005223000A	-	●	
	2,875	0,5	0,55	93 AU 2093 / N3101	LSU	31202250500B-2093	-	○	
	2,929	0,217	0,234	92 AU 9250 / PA	HBY	8012160001	-	●	
	3	0,375	0,406	92 AU 9250	SYM	005228000A	-	●	
	3	0,375	0,413	93 AU 2093 / N3101	LSU	37502250-2093	-	○	

d [inch]	D [inch]	H [inch]	L [inch]	Material	Design	Part No.	PU ¹⁾	US	EU
2,25	3	0,375	0,413	93 AU 2093 / N3101	LSU	375022505QB-2093	-	○	
	3	0,5	0,531	92 AU 9250	SYM	005227000A	-	●	
	3	0,5	0,55	93 AU 2093 / N3101	LSU	37502250500B-2093	-	●	
	3	0,625	0,656	92 AU 9250	SYM	005226000A	-	●	
	3	0,625	0,688	93 AU 2093 / N3101	LSU	37502250625B-2093	-	○	
	3,25	0,5	0,55	93 AU 2093 / N3101	LSU	50002250-2093	-	○	
2,375	2,75	0,188	0,207	93 AU 2093 / N3101	LSU	18702375-2093	-	●	
	2,75	0,375	0,406	92 AU 9250	SYM	560005229000A	-	●	
	2,75	0,375	0,413	93 AU 2093 / N3101	LSU	18702375375-2093	-	○	
	2,75	0,375	0,413	93 AU 2093 / N3101	LSU	18702375375B-2093	-	●	
	2,875	0,313	0,343	92 AU 9250	RO	560001165000A	-	○	
	2,875	0,375	0,406	94 AU 30000	D 300	560G01164000B	-	●	
	2,875	0,375	0,406	92 AU 9250	RO	560001164000A	-	●	
	2,875	0,375	0,406	92 AU 9250	SYM	005231000A	-	●	
	2,875	0,375	0,413	93 AU 2093 / N3101	LSU	25002375375B-2093	-	○	
	3	0,313	0,343	92 AU 9250	SYM	560005233G00A	-	○	
	3	0,313	0,344	93 AU 2093 / N3101	LSU	31202375-2093	-	●	
	3	0,375	0,406	94 AU 30000	RO	560001168000B	-	●	
	3	0,375	0,406	92 AU 9250	SYM	560005235000A	-	●	
	3	0,5	0,531	92 AU 9250	RO	001166000A	-	○	
	3	0,5	0,531	92 AU 9250	SYM	560005233000A	-	●	
	3	0,5	0,55	93 AU 2093 / N3101	LSU	31202375500B-2093	-	○	
	3,125	0,375	0,413	93 AU 2093 / N3101	LSU	37502375-2093	-	○	
	2,5	2,75	0,125	0,138	93 AU 2093 / N3101	LSU	12502500-2093	-	○
2,875		0,188	0,207	93 AU 2093 / N3101	LSU	18702500-2093	-	●	
2,875		0,188	0,207	93 AU 2093 / N3101	LSU	187025005QB-2093	-	○	
2,875		0,25	0,275	93 AU 2093 / N3101	LSU	18702500250B-2093	-	○	
2,875		0,25	0,281	92 AU 9250	SYM	560005239E00A	-	●	
2,875		0,313	0,343	92 AU 9250	RO	560001170000A	-	●	
2,875		0,313	0,344	93 AU 2093 / N3101	LSU	18702500312B-2093	-	○	
2,875		0,375	0,406	94 AU 30000	D 300	560G01169000B	-	●	
2,875		0,375	0,406	94 AU 30000	RO	560001169000B	-	●	
2,875		0,375	0,406	92 AU 9250	SYM	560005239000A	-	●	
2,875		0,375	0,413	93 AU 2093 / N3101	LSU	18702500375-2093	-	○	
2,875		0,375	0,413	93 AU 2093 / N3101	LSU	18702500375B-2093	-	○	
2,937		0,289	0,309	92 AU 9250	D 300	560G01406000A	-	○	
2,938		0,281	0,309	92 AU 9250	D 300	560G01413000A	-	○	
3		0,25	0,275	93 AU 2093 / N3101	LSU	25002500-2093	-	●	
3		0,25	0,275	93 AU 2093 / N3101	LSU	250025005QB-2093	-	○	
3		0,25	0,281	92 AU 9250	SYM	560005240E00A	-	●	
3		0,265	0,281	92 AU 9250	RO	560001171E00A	-	●	
3		0,313	0,343	92 AU 9250	SYM	560005241000A	-	●	
3		0,327	0,343	92 AU 9250	RO	560001172000A	-	●	
3		0,375	0,406	94 AU 30000	D 300	560G01171000B	-	●	
3		0,375	0,406	94 AU 30000	RO	560001171000B	-	●	
3		0,375	0,406	92 AU 9250	SYM	560005240000A	-	●	
3		0,375	0,413	93 AU 2093 / N3101	LSU	25002500375-2093	-	○	
3		0,375	0,413	93 AU 2093 / N3101	LSU	25002500375B-2093	-	○	
3		0,5	0,55	93 AU 2093 / N3101	LSU	25002500500B-2093	-	○	
3,125		0,313	0,343	92 AU 9250	SYM	560005242G00A	-	○	

d [inch]	D [inch]	H [inch]	L [inch]	Material	Design	Part No.	PU ¹⁾	US	EU	
2,5	3,125	0,313	0,344	93 AU 2093 / N3101	LSU	31202500-2093	-	○		
	3,125	0,313	0,344	93 AU 2093 / N3101	LSU	31202500SQB-2093	-	○		
	3,125	0,375	0,406	92 AU 9250	RO	560001175000A	-	○		
	3,125	0,375	0,406	92 AU 9250	SYM	560005244000A	-	○		
	3,125	0,438	0,468	92 AU 9250	RO	560001174000A	-	○		
	3,125	0,5	0,531	92 AU 9250	D 300	560G01173000A	-	●		
	3,125	0,5	0,531	92 AU 9250	RO	560001173000A	-	●		
	3,125	0,5	0,531	92 AU 9250	SYM	560005242000A	-	●		
	3,125	0,5	0,55	93 AU 2093 / N3101	LSU	31202500500B-2093	-	○		
	3,125	0,625	0,688	93 AU 2093 / N3101	LSU	31202500625B-2093	-	○		
	3,177	0,217	0,234	92 AU 9250 / PA	HBV	8012170001	-	●		
	3,25	0,375	0,406	92 AU 9250	SYM	560005247000A	-	●		
	3,25	0,375	0,413	93 AU 2093 / N3101	LSU	37502500-2093	-	●		
	3,25	0,375	0,413	93 AU 2093 / N3101	LSU	37502500SQB-2093	-	○		
	3,25	0,5	0,531	92 AU 9250	SYM	560005246000A	-	●		
	3,25	0,5	0,55	93 AU 2093 / N3101	LSU	37502500500B-2093	-	○		
	3,25	0,625	0,656	92 AU 9250	SYM	560005245000A	-	●		
	3,25	0,625	0,688	93 AU 2093 / N3101	LSU	37502500625-2093	-	○		
	3,25	0,625	0,688	93 AU 2093 / N3101	LSU	37502500625B-2093	-	○		
	3,5	0,5	0,55	93 AU 2093 / N3101	LSU	50002500-2093	-	○		
3,5	0,75	0,825	93 AU 2093 / N3101	LSU	50002500750-2093	-	○			
2,563	3,063	0,375	0,413	93 AU 2093 / N3101	LSU	25002562375B-2093	-	○		
2,625	2,875	0,125	0,138	93 AU 2093 / N3101	LSU	12502625-2093	-	○		
	3	0,188	0,207	93 AU 2093 / N3101	LSU	18702625-2093	-	●		
	3	0,25	0,281	92 AU 9250	SYM	560005248E00A	-	●		
	3	0,281	0,312	92 AU 9250	SYM	560005248F00A	-	○		
	3	0,312	0,343	92 AU 9250	SYM	560005248G00A	-	○		
	3	0,375	0,406	92 AU 9250	D 300	560G01383000A	-	○		
	3	0,375	0,406	92 AU 9250	SYM	560005248000A	-	●		
	3	0,375	0,413	93 AU 2093 / N3101	LSU	18702625375B-2093	-	○		
	3,125	0,25	0,281	92 AU 9250	SYM	560005249E00A	-	○		
	3,125	0,375	0,406	92 AU 9250	RO	560001176000A	-	●		
	3,125	0,375	0,406	92 AU 9250	SYM	560005249000A	-	●		
	3,25	0,375	0,406	92 AU 9250	SYM	560005251000A	-	●		
	3,25	0,5	0,531	92 AU 9250	SYM	560005250000A	-	○		
	3,25	0,5	0,55	93 AU 2093 / N3101	LSU	31202625500B-2093	-	○		
	3,375	0,375	0,406	92 AU 9250	SYM	560005254000A	-	○		
	3,375	0,5	0,531	92 AU 9250	SYM	560005253000A	-	○		
	3,375	0,625	0,656	92 AU 9250	SYM	560005252000A	-	○		
	2,688	3,188	0,375	0,406	92 AU 9250	D 300	560G01401000A	-	●	
	2,75	3	0,25	0,275	93 AU 2093 / N3101	LSU	12502750250B-2093	-	○	
		3,125	0,188	0,207	93 AU 2093 / N3101	LSU	18702750-2093	-	○	
3,125		0,375	0,413	93 AU 2093 / N3101	LSU	18702750375-2093	-	○		
3,125		0,375	0,413	93 AU 2093 / N3101	LSU	18702750375B-2093	-	○		
3,25		0,25	0,275	93 AU 2093 / N3101	LSU	25002750-2093	-	○		
3,25		0,25	0,275	93 AU 2093 / N3101	LSU	25002750SQB-2093	-	●		
3,25		0,25	0,281	92 AU 9250	SYM	560005255E00A	-	○		
3,25		0,375	0,406	94 AU 30000	D 300	560G01182000B	-	●		
3,25		0,375	0,406	94 AU 30000	RO	560001182000B	-	●		
3,25		0,375	0,406	92 AU 9250	SYM	560005255000A	-	●		

d [inch]	D [inch]	H [inch]	L [inch]	Material	Design	Part No.	PU ¹⁾	US	EU
2,75	3,25	0,375	0,413	93 AU 2093 / N3101	LSU	25002750375B-2093	-	●	
	3,375	0,313	0,344	93 AU 2093 / N3101	LSU	31202750-2093	-	○	
	3,375	0,375	0,406	92 AU 9250	RO	560001184000A	-	●	
	3,375	0,5	0,531	92 AU 9250	D 300	560G01183000A	-	●	
	3,375	0,5	0,531	92 AU 9250	RO	560001183000A	-	●	
	3,402	0,217	0,234	92 AU 9250 / PA	HBV	8012180001	-	●	
	3,5	0,375	0,406	92 AU 9250	SYM	560005259000A	-	●	
	3,5	0,375	0,413	93 AU 2093 / N3101	LSU	37502750-2093	-	●	
	3,5	0,375	0,413	93 AU 2093 / N3101	LSU	37502750SQB-2093	-	○	
	3,5	0,44	0,469	92 AU 9250	SYM	560005258Z00A	-	○	
	3,5	0,5	0,531	92 AU 9250	SYM	005258000A	-	●	
	3,5	0,5	0,55	93 AU 2093 / N3101	LSU	37502750500B-2093	-	○	
	3,5	0,625	0,656	92 AU 9250	RO	560001185000A	-	○	
	3,5	0,625	0,656	92 AU 9250	SYM	005257000A	-	●	
	3,5	0,625	0,688	93 AU 2093 / N3101	LSU	37502750625B-2093	-	●	
2,875	3,25	0,188	0,207	93 AU 2093 / N3101	LSU	18702875-2093	-	○	
	3,25	0,188	0,218	92 AU 9250	SYM	560005260C00A	-	○	
	3,25	0,25	0,275	93 AU 2093 / N3101	LSU	18702875250B-2093	-	○	
	3,25	0,25	0,281	92 AU 9250	SYM	560005260E00A	-	●	
	3,25	0,375	0,406	92 AU 9250	SYM	005260000A	-	●	
	3,375	0,25	0,275	93 AU 2093 / N3101	LSU	25002875-2093	-	○	
	3,375	0,375	0,406	92 AU 9250	SYM	005261000A	-	●	
	3,5	0,375	0,406	92 AU 9250	SYM	005263000A	-	●	
	3,5	0,5	0,531	92 AU 9250	SYM	005262000A	-	○	
	3,5	0,5	0,55	93 AU 2093 / N3101	LSU	31202875500B-2093	-	○	
3	3,25	0,125	0,138	93 AU 2093 / N3101	LSU	12503000-2093	-	○	
	3,375	0,125	0,156	92 AU 9250	RO	560001399000A	-	○	
	3,375	0,188	0,207	93 AU 2093 / N3101	LSU	18703000-2093	-	○	
	3,375	0,25	0,275	93 AU 2093 / N3101	LSU	18703000250-2093	-	○	
	3,375	0,25	0,275	93 AU 2093 / N3101	LSU	18703000250B-2093	-	○	
	3,375	0,375	0,406	92 AU 9250	SYM	560005267000A	-	●	
	3,375	0,375	0,413	93 AU 2093 / N3101	LSU	18703000375-2093	-	○	
	3,375	0,375	0,413	93 AU 2093 / N3101	LSU	18703000375B-2093	-	○	
	3,438	0,281	0,309	92 AU 9250	D 300	560G01414000A	-	●	
	3,5	0,25	0,275	93 AU 2093 / N3101	LSU	25003000-2093	-	●	
	3,5	0,25	0,275	93 AU 2093 / N3101	LSU	25003000SQB-2093	-	○	
	3,5	0,25	0,281	92 AU 9250	SYM	560005268E00A	-	●	
	3,5	0,375	0,406	94 AU 30000	D 300	560G01191000B	-	●	
	3,5	0,375	0,406	92 AU 9250	RO	560001191000A	-	●	
	3,5	0,375	0,406	92 AU 9250	SYM	560005268000A	-	●	
	3,5	0,375	0,413	93 AU 2093 / N3101	LSU	25003000375-2093	-	●	
	3,5	0,375	0,413	93 AU 2093 / N3101	LSU	25003000375B-2093	-	○	
	3,625	0,313	0,344	93 AU 2093 / N3101	LSU	31203000-2093	-	●	
	3,625	0,375	0,406	92 AU 9250	RO	560001193000A	-	●	
	3,625	0,375	0,406	92 AU 9250	SYM	005270000A	-	●	
	3,625	0,375	0,413	93 AU 2093 / N3101	LSU	31203000375B-2093	-	○	
	3,625	0,5	0,531	92 AU 9250	D 300	560G01192000A	-	●	
	3,625	0,5	0,531	94 AU 30000	RO	560001192000B	-	●	
3,625	0,5	0,531	92 AU 9250	SYM	005269000A	-	●		
3,625	0,5	0,55	93 AU 2093 / N3101	LSU	31203000500-2093	-	○		

d [inch]	D [inch]	H [inch]	L [inch]	Material	Design	Part No.	PU ¹⁾	US	EU
3	3,649	0,217	0,234	92 AU 9250 / PA	HBV	8012190001	-	●	
	3,75	0,375	0,406	94 AU 30000	RO	560001196000B	-	●	
	3,75	0,375	0,406	92 AU 9250	SYM	005273000A	-	●	
	3,75	0,375	0,413	93 AU 2093 / N3101	LSU	37503000-2093	-	●	
	3,75	0,375	0,413	93 AU 2093 / N3101	LSU	37503000SQB-2093	-	○	
	3,75	0,5	0,531	92 AU 9250	D 300	560G01195000A	-	●	
	3,75	0,5	0,531	92 AU 9250	RO	560001195000A	-	●	
	3,75	0,5	0,531	92 AU 9250	SYM	560005272000A	-	●	
	3,75	0,5	0,55	93 AU 2093 / N3101	LSU	37503000500B-2093	-	●	
	3,75	0,625	0,656	92 AU 9250	RO	560001194000A	-	●	
	3,75	0,625	0,656	92 AU 9250	SYM	005271000A	-	○	
	3,75	0,625	0,688	93 AU 2093 / N3101	LSU	37503000625-2093	-	○	
	3,75	0,625	0,688	93 AU 2093 / N3101	LSU	37503000625B-2093	-	○	
	4	0,5	0,531	92 AU 9250	SYM	560005524000A	-	●	
	4	0,5	0,55	93 AU 2093 / N3101	LSU	50003000-2093	-	○	
	4	0,5	0,55	93 AU 2093 / N3101	LSU	50003000SQB-2093	-	○	
	4	0,625	0,688	93 AU 2093 / N3101	LSU	50003000625B-2093	-	○	
	4	0,75	0,825	93 AU 2093 / N3101	LSU	50003000750B-2093	-	○	
3,125	3,5	0,188	0,207	93 AU 2093 / N3101	LSU	18703125-2093	-	○	
	3,5	0,188	0,207	93 AU 2093 / N3101	LSU	18703125SQB-2093	-	○	
	3,5	0,375	0,406	92 AU 9250	D 300	560G01403000A	-	○	
	3,5	0,375	0,406	92 AU 9250	SYM	560005274000A	-	●	
	3,5	0,375	0,413	93 AU 2093 / N3101	LSU	18703125375B-2093	-	○	
	3,625	0,375	0,406	92 AU 9250	RO	001197000A	-	○	
	3,75	0,375	0,406	92 AU 9250	RO	560001199000A	-	○	
	3,75	0,375	0,406	92 AU 9250	SYM	005277000A	-	●	
	3,75	0,5	0,531	92 AU 9250	SYM	005276000A	-	●	
3,25	3,875	0,625	0,688	93 AU 2093 / N3101	LSU	37503125625B-2093	-	○	
	3,625	0,375	0,406	92 AU 9250	SYM	005278000A	-	○	
	3,625	0,375	0,413	93 AU 2093 / N3101	LSU	18703250375B-2093	-	○	
	3,75	0,25	0,275	93 AU 2093 / N3101	LSU	25003250-2093	-	○	
	3,75	0,375	0,406	94 AU 30000	D 300	560G01203000B	-	●	
	3,75	0,375	0,406	94 AU 30000	RO	560001203000B	-	●	
	3,75	0,375	0,406	92 AU 9250	SYM	560005279000A	-	●	
	3,75	0,375	0,413	93 AU 2093 / N3101	LSU	25003250375B-2093	-	●	
	3,875	0,313	0,344	93 AU 2093 / N3101	LSU	31203250-2093	-	○	
	3,875	0,5	0,531	92 AU 9250	D 300	560G01204000A	-	○	
	3,875	0,5	0,531	92 AU 9250	RO	560001204000A	-	●	
	3,875	0,5	0,55	93 AU 2093 / N3101	LSU	31203250500B-2093	-	○	
	4	0,375	0,406	92 AU 9250	SYM	005284000A	-	●	
	4	0,375	0,413	93 AU 2093 / N3101	LSU	37503250-2093	-	●	
	4	0,375	0,413	93 AU 2093 / N3101	LSU	37503250SQB-2093	-	●	
	4	0,5	0,531	92 AU 9250	SYM	005283000A	-	●	
	4	0,5	0,55	93 AU 2093 / N3101	LSU	37503250500B-2093	-	○	
	4	0,625	0,656	92 AU 9250	SYM	005282000A	-	●	
4	0,625	0,688	93 AU 2093 / N3101	LSU	37503250625B-2093	-	○		
3,375	3,75	0,188	0,207	93 AU 2093 / N3101	LSU	18703375-2093	-	○	
	3,75	0,375	0,406	92 AU 9250	SYM	005285000A	-	●	
	3,75	0,375	0,413	93 AU 2093 / N3101	LSU	18703375375B-2093	-	○	
	3,875	0,25	0,275	93 AU 2093 / N3101	LSU	25003375SQB-2093	-	●	

d [inch]	D [inch]	H [inch]	L [inch]	Material	Design	Part No.	PU ¹⁾	US	EU
3,375	3,875	0,375	0,406	92 AU 9250	D 300	560G01209000A	-	○	
	3,875	0,375	0,406	92 AU 9250	RO	001209000A	-	○	
	3,875	0,375	0,406	92 AU 9250	SYM	005286000A	-	●	
	4	0,313	0,344	93 AU 2093 / N3101	LSU	31203375-2093	-	○	
	4	0,5	0,531	92 AU 9250	RO	001210000A	-	○	
	4	0,5	0,55	93 AU 2093 / N3101	LSU	31203375500-2093	-	○	
3,5	4	0,5	0,55	93 AU 2093 / N3101	LSU	31203375500B-2093	-	○	
	3,875	0,188	0,207	93 AU 2093 / N3101	LSU	18703500-2093	-	○	
	3,875	0,25	0,275	93 AU 2093 / N3101	LSU	18703500250B-2093	-	○	
	3,875	0,375	0,406	92 AU 9250	SYM	560005292000A	-	●	
	3,875	0,375	0,413	93 AU 2093 / N3101	LSU	18703500375-2093	-	○	
	3,875	0,375	0,413	93 AU 2093 / N3101	LSU	18703500375B-2093	-	●	
	4	0,188	0,207	93 AU 2093 / N3101	LSU	25003500187B-2093	-	○	
	4	0,25	0,275	93 AU 2093 / N3101	LSU	25003500-2093	-	●	
	4	0,25	0,275	93 AU 2093 / N3101	LSU	25003500SQB-2093	-	●	
	4	0,25	0,281	92 AU 9250	SYM	560005293E00A	-	●	
	4	0,312	0,343	92 AU 9250	SYM	560005293G00A	-	○	
	4	0,313	0,343	92 AU 9250	D 300	560G01415000A	-	●	
	4	0,375	0,406	94 AU 30000	D 300	560G01212000B	-	●	
	4	0,375	0,406	94 AU 30000	RO	560001212000B	-	●	
	4	0,375	0,406	92 AU 9250	SYM	560005293000A	-	●	
	4	0,375	0,413	93 AU 2093 / N3101	LSU	25003500375-2093	-	○	
	4	0,375	0,413	93 AU 2093 / N3101	LSU	25003500375B-2093	-	●	
	4	0,5	0,55	93 AU 2093 / N3101	LSU	25003500500-2093	-	○	
	4	0,5	0,55	93 AU 2093 / N3101	LSU	25003500500B-2093	-	●	
	4,125	0,375	0,406	92 AU 9250	SYM	005295000A	-	●	
	4,125	0,5	0,531	92 AU 9250	SYM	005294000A	-	●	
	4,125	0,5	0,55	93 AU 2093 / N3101	LSU	31203500500B-2093	-	○	
	4,169	0,217	0,234	92 AU 9250 / PA	HBY	8012200001	-	●	
	4,25	0,375	0,406	92 AU 9250	RO	560001215Y00A	-	○	
	4,25	0,375	0,406	92 AU 9250	RO	560001217000A	-	●	
	4,25	0,375	0,406	92 AU 9250	SYM	005298000A	-	●	
	4,25	0,375	0,413	93 AU 2093 / N3101	LSU	37503500-2093	-	○	
	4,25	0,375	0,413	93 AU 2093 / N3101	LSU	37503500SQB-2093	-	○	
	4,25	0,5	0,531	92 AU 9250	RO	560001216000A	-	●	
	4,25	0,5	0,531	92 AU 9250	SYM	005297000A	-	●	
	4,25	0,5	0,55	93 AU 2093 / N3101	LSU	37503500500-2093	-	○	
	4,25	0,625	0,656	92 AU 9250	D 300	560G01215000A	-	●	
4,25	0,625	0,656	92 AU 9250	RO	560001215000A	-	●		
4,25	0,625	0,656	92 AU 9250	SYM	560005296000A	-	●		
4,25	0,625	0,688	93 AU 2093 / N3101	LSU	37503500625B-2093	-	○		
4,5	0,5	0,531	92 AU 9250	SYM	005301000A	-	●		
4,5	0,5	0,55	93 AU 2093 / N3101	LSU	50003500-2093	-	●		
4,5	0,625	0,656	92 AU 9250	RO	001219000A	-	○		
4,5	0,625	0,656	92 AU 9250	SYM	005300000A	-	○		
4,5	0,656	0,687	92 AU 9250	SYM	560005299S00A	-	○		
4,5	0,75	0,781	92 AU 9250	RO	001218000A	-	○		
4,5	0,75	0,825	93 AU 2093 / N3101	LSU	50003500750B-2093	-	●		
3,625	4	0,188	0,207	93 AU 2093 / N3101	LSU	18703625-2093	-	●	
	4	0,188	0,207	93 AU 2093 / N3101	LSU	18703625SQB-2093	-	○	

d [inch]	D [inch]	H [inch]	L [inch]	Material	Design	Part No.	PU ¹⁾	US	EU
3,625	4	0,25	0,281	92 AU 9250	SYM	560005302E00A	-	○	
	4	0,375	0,406	92 AU 9250	SYM	560005302000A	-	●	
	4	0,375	0,413	93 AU 2093 / N3101	LSU	18703625375-2093	-	○	
	4	0,375	0,413	93 AU 2093 / N3101	LSU	18703625375B-2093	-	○	
	4,125	0,375	0,406	92 AU 9250	SYM	005303000A	-	○	
	4,125	0,375	0,413	93 AU 2093 / N3101	LSU	25003625375B-2093	-	○	
	4,25	0,313	0,344	93 AU 2093 / N3101	LSU	31203625-2093	-	○	
	4,25	0,375	0,406	92 AU 9250	SYM	005305000A	-	●	
	4,25	0,5	0,55	93 AU 2093 / N3101	LSU	31203625500B-2093	-	○	
	4,375	0,375	0,406	92 AU 9250	RO	560001226000A	-	○	
	4,375	0,5	0,531	92 AU 9250	RO	560001225000A	-	○	
	4,375	0,5	0,55	93 AU 2093 / N3101	LSU	37503625500B-2093	-	○	
	4,375	0,625	0,688	93 AU 2093 / N3101	LSU	37503625625B-2093	-	○	
	3,75	4,125	0,188	0,207	93 AU 2093 / N3101	LSU	18703750-2093	-	○
4,125		0,375	0,406	92 AU 9250	SYM	560005307000A	-	●	
4,125		0,375	0,413	93 AU 2093 / N3101	LSU	18703750375B-2093	-	○	
4,25		0,25	0,275	93 AU 2093 / N3101	LSU	25003750-2093	-	○	
4,25		0,375	0,406	94 AU 30000	D 300	560G01227000B	-	●	
4,25		0,375	0,406	92 AU 9250	RO	560001227000A	-	●	
4,25		0,375	0,406	92 AU 9250	SYM	560005308000A	-	●	
4,25		0,375	0,413	93 AU 2093 / N3101	LSU	25003750375-2093	-	○	
4,25		0,375	0,413	93 AU 2093 / N3101	LSU	25003750375B-2093	-	●	
4,25		0,5	0,55	93 AU 2093 / N3101	LSU	25003750500B-2093	-	○	
4,375		0,313	0,344	93 AU 2093 / N3101	LSU	31203750-2093	-	○	
4,375		0,375	0,406	92 AU 9250	RO	560001229000A	-	○	
4,375		0,375	0,413	93 AU 2093 / N3101	LSU	31203750375B-2093	-	○	
4,375		0,5	0,531	92 AU 9250	RO	560001228000A	-	○	
4,375		0,5	0,55	93 AU 2093 / N3101	LSU	31203750500B-2093	-	○	
4,375		0,625	0,688	93 AU 2093 / N3101	LSU	31203750625B-2093	-	○	
4,5		0,375	0,406	92 AU 9250	SYM	560005313000A	-	●	
4,5		0,375	0,413	93 AU 2093 / N3101	LSU	37503750-2093	-	●	
4,5		0,5	0,531	92 AU 9250	D 300	560G01231000A	-	○	
4,5		0,5	0,531	92 AU 9250	RO	560001231000A	-	●	
4,5		0,5	0,531	92 AU 9250	SYM	560005312000A	-	●	
4,5		0,5	0,55	93 AU 2093 / N3101	LSU	37503750500B-2093	-	○	
4,5		0,625	0,656	92 AU 9250	SYM	560005311000A	-	●	
4,5		0,625	0,688	93 AU 2093 / N3101	LSU	37503750625-2093	-	○	
4,5	0,625	0,688	93 AU 2093 / N3101	LSU	37503750625B-2093	-	○		
5	0,625	0,688	93 AU 2093 / N3101	LSU	62503750-2093	-	○		
3,875	4,25	0,375	0,406	92 AU 9250	SYM	005516000A	-	○	
	4,25	0,375	0,413	93 AU 2093 / N3101	LSU	18703875375B-2093	-	○	
	4,5	0,375	0,406	92 AU 9250	SYM	005316000A	-	●	
	4,5	0,5	0,531	92 AU 9250	SYM	005315000A	-	●	
	4,5	0,5	0,55	93 AU 2093 / N3101	LSU	31203875500-2093	-	○	
	4,625	0,375	0,413	93 AU 2093 / N3101	LSU	37503875-2093	-	○	
	4,75	0,75	0,825	93 AU 2093 / N3101	LSU	43703875750B-2093	-	○	
4	4,25	0,125	0,138	93 AU 2093 / N3101	LSU	12504000-2093	-	○	
	4,375	0,188	0,207	93 AU 2093 / N3101	LSU	18704000-2093	-	○	
	4,375	0,25	0,275	93 AU 2093 / N3101	LSU	18704000250B-2093	-	○	
	4,375	0,375	0,406	92 AU 9250	SYM	560005322000A	-	●	

d [inch]	D [inch]	H [inch]	L [inch]	Material	Design	Part No.	PU ¹⁾	US	EU
4	4,375	0,375	0,413	93 AU 2093 / N3101	LSU	18704000375B-2093	-	○	
	4,5	0,25	0,275	93 AU 2093 / N3101	LSU	25004000-2093	-	●	
	4,5	0,25	0,275	93 AU 2093 / N3101	LSU	25004000SQB-2093	-	●	
	4,5	0,265	0,281	92 AU 9250	RO	560001236E00A	-	○	
	4,5	0,312	0,343	92 AU 9250	SYM	560005517G00A	-	○	
	4,5	0,313	0,343	92 AU 9250	D 300	560G01408000A	-	●	
	4,5	0,375	0,406	94 AU 30000	D 300	560G01236I00B	-	●	
	4,5	0,375	0,406	92 AU 9250	RO	560001236I00A	-	●	
	4,5	0,375	0,406	92 AU 9250	SYM	560005517I00A	-	●	
	4,5	0,375	0,413	93 AU 2093 / N3101	LSU	25004000375-2093	-	●	
	4,5	0,375	0,413	93 AU 2093 / N3101	LSU	25004000375B-2093	-	●	
	4,5	0,5	0,55	93 AU 2093 / N3101	LSU	25004000500B-2093	-	○	
	4,5	0,563	0,593	92 AU 9250	D 300	560G01236000A	-	●	
	4,5	0,563	0,593	92 AU 9250	RO	560001236000A	-	●	
	4,5	0,563	0,593	92 AU 9250	SYM	560005517000A	-	●	
	4,5	0,563	0,618	93 AU 2093 / N3101	LSU	25004000562-2093	-	○	
	4,5	0,563	0,618	93 AU 2093 / N3101	LSU	25004000562B-2093	-	○	
	4,5	0,625	0,688	93 AU 2093 / N3101	LSU	25004000625-2093	-	○	
	4,625	0,313	0,344	93 AU 2093 / N3101	LSU	31204000-2093	-	●	
	4,625	0,375	0,406	92 AU 9250	D 300	560G01238000A	-	●	
	4,625	0,375	0,406	94 AU 30000	RO	560001238000B	-	●	
	4,625	0,375	0,406	92 AU 9250	SYM	005325000A	-	●	
	4,625	0,375	0,413	93 AU 2093 / N3101	LSU	31204000375-2093	-	○	
	4,625	0,5	0,531	92 AU 9250	RO	001237000A	-	●	
	4,625	0,5	0,55	93 AU 2093 / N3101	LSU	31204000500B-2093	-	○	
	4,625	0,563	0,618	93 AU 2093 / N3101	LSU	31204000562B-2093	-	○	
	4,669	0,217	0,234	92 AU 9250 / PA	HBV	8012210001	-	●	
	4,75	0,375	0,406	92 AU 9250	RO	560001241000A	-	●	
	4,75	0,375	0,406	92 AU 9250	SYM	560005328000A	-	●	
	4,75	0,375	0,413	93 AU 2093 / N3101	LSU	37504000SQB-2093	-	○	
	4,75	0,437	0,469	92 AU 9250	SYM	005326K00A	-	○	
	4,75	0,5	0,531	92 AU 9250	D 300	560G01240000A	-	●	
4,75	0,5	0,531	92 AU 9250	RO	560001240000A	-	●		
4,75	0,5	0,531	92 AU 9250	SYM	560005327000A	-	●		
4,75	0,5	0,55	93 AU 2093 / N3101	LSU	37504000500B-2093	-	○		
4,75	0,625	0,656	94 AU 30000	D 300	560G01239000B	-	●		
4,75	0,625	0,656	92 AU 9250	RO	001239000A	-	●		
4,75	0,625	0,656	92 AU 9250	SYM	005326000A	-	●		
4,75	0,625	0,688	93 AU 2093 / N3101	LSU	37504000625B-2093	-	●		
5	0,5	0,55	93 AU 2093 / N3101	LSU	50004000-2093	-	●		
5	0,75	0,825	93 AU 2093 / N3101	LSU	50004000750-2093	-	○		
5	0,75	0,825	93 AU 2093 / N3101	LSU	50004000750B-2093	-	○		
4,125	4,5	0,188	0,207	93 AU 2093 / N3101	LSU	18704125-2093	-	●	
	4,5	0,375	0,413	93 AU 2093 / N3101	LSU	18704125375-2093	-	○	
	4,5	0,375	0,413	93 AU 2093 / N3101	LSU	18704125375B-2093	-	○	
	4,625	0,25	0,275	93 AU 2093 / N3101	LSU	25004125-2093	-	○	
	4,625	0,563	0,593	92 AU 9250	SYM	005330000A	-	○	
	4,75	0,5	0,531	92 AU 9250	SYM	005332000A	-	●	
4,75	0,563	0,593	92 AU 9250	SYM	005331000A	-	○		
4,75	0,563	0,618	93 AU 2093 / N3101	LSU	31204125562B-2093	-	●		

d [inch]	D [inch]	H [inch]	L [inch]	Material	Design	Part No.	PU ¹⁾	US	EU
4,125	4,875	0,375	0,413	93 AU 2093 / N3101	LSU	37504125-2093	-	○	
	4,875	0,5	0,531	92 AU 9250	RO	560001245000A	-	○	
	4,875	0,625	0,656	92 AU 9250	SYM	005334000A	-	○	
	5,125	0,5	0,55	93 AU 2093 / N3101	LSU	50004125-2093	-	○	
	5,125	0,75	0,825	93 AU 2093 / N3101	LSU	50004125750B-2093	-	○	
4,25	4,625	0,188	0,207	93 AU 2093 / N3101	LSU	18704250-2093	-	○	
	4,75	0,25	0,275	93 AU 2093 / N3101	LSU	25004250-2093	-	●	
	4,75	0,25	0,275	93 AU 2093 / N3101	LSU	25004250SQB-2093	-	○	
	4,75	0,375	0,406	92 AU 9250	SYM	56000533700A	-	●	
	4,75	0,563	0,593	92 AU 9250	RO	560001247000A	-	●	
	4,75	0,563	0,593	92 AU 9250	SYM	005337000A	-	●	
	4,75	0,563	0,618	93 AU 2093 / N3101	LSU	25004250562B-2093	-	●	
	4,875	0,313	0,344	93 AU 2093 / N3101	LSU	31204250-2093	-	○	
	4,875	0,563	0,618	93 AU 2093 / N3101	LSU	31204250562B-2093	-	○	
	5	0,375	0,406	92 AU 9250	SYM	56000534100A	-	●	
	5	0,375	0,413	HT 2053 / N3101	LSU	37504250-2053	-	○	
	5	0,375	0,413	93 AU 2093 / N3101	LSU	37504250-2093	-	●	
	5	0,375	0,413	93 AU 2093 / N3101	LSU	37504250SQB-2093	-	○	
	5	0,5	0,531	92 AU 9250	RO	001249000A	-	○	
	5	0,5	0,531	92 AU 9250	SYM	560005342000A	-	●	
	5	0,5	0,55	93 AU 2093 / N3101	LSU	37504250500-2093	-	○	
	5	0,5	0,55	93 AU 2093 / N3101	LSU	37504250500B-2093	-	●	
	5	0,625	0,656	92 AU 9250	D 300	560G01248000A	-	○	
	5	0,625	0,656	92 AU 9250	SYM	560005341000A	-	●	
	5	0,625	0,688	93 AU 2093 / N3101	LSU	37504250625-2093	-	●	
5	0,625	0,688	93 AU 2093 / N3101	LSU	37504250625B-2093	-	●		
5,5	0,625	0,688	93 AU 2093 / N3101	LSU	62504250-2093	-	○		
4,375	4,75	0,188	0,207	93 AU 2093 / N3101	LSU	18704375-2093	-	○	
	4,75	0,375	0,406	92 AU 9250	SYM	005343000A	-	○	
	4,75	0,375	0,413	93 AU 2093 / N3101	LSU	18704375375-2093	-	○	
	4,75	0,375	0,413	93 AU 2093 / N3101	LSU	18704375375B-2093	-	○	
	4,875	0,25	0,275	93 AU 2093 / N3101	LSU	25004375-2093	-	○	
	5	0,313	0,344	93 AU 2093 / N3101	LSU	31204375-2093	-	●	
	5	0,375	0,406	92 AU 9250	SYM	560005346000A	-	●	
	5	0,5	0,531	92 AU 9250	SYM	560005345000A	-	●	
	5	0,5	0,55	93 AU 2093 / N3101	LSU	31204375500-2093	-	○	
	5	0,563	0,593	92 AU 9250	SYM	560005344000A	-	●	
	5	0,563	0,618	93 AU 2093 / N3101	LSU	31204375562B-2093	-	●	
	5	0,625	0,688	93 AU 2093 / N3101	LSU	31204375625B-2093	-	○	
	5,125	0,375	0,413	93 AU 2093 / N3101	LSU	37504375-2093	-	○	
	5,125	0,5	0,531	92 AU 9250	RO	001251000A	-	●	
	5,125	0,625	0,688	93 AU 2093 / N3101	LSU	37504375625B-2093	-	○	
5,375	0,5	0,55	93 AU 2093 / N3101	LSU	50004375-2093	-	○		
4,5	4,875	0,188	0,207	93 AU 2093 / N3101	LSU	18704500-2093	-	○	
	4,875	0,375	0,406	92 AU 9250	SYM	005349000A	-	○	
	4,875	0,375	0,413	93 AU 2093 / N3101	LSU	18704500375-2093	-	○	
	5	0,25	0,275	93 AU 2093 / N3101	LSU	25004500-2093	-	●	
	5	0,313	0,343	92 AU 9250	D 300	560G01417000A	-	○	
	5	0,313	0,344	93 AU 2093 / N3101	LSU	25004500312B-2093	-	○	
	5	0,375	0,406	92 AU 9250	SYM	00535000A	-	●	

d [inch]	D [inch]	H [inch]	L [inch]	Material	Design	Part No.	PU ¹⁾	US	EU
	5	0,375	0,413	93 AU 2093 / N3101	LSU	25004500375-2093	-	●	
	5	0,375	0,413	93 AU 2093 / N3101	LSU	25004500375B-2093	-	●	
	5	0,5	0,531	92 AU 9250	SYM	560005350M00A	-	●	
	5	0,5	0,55	93 AU 2093 / N3101	LSU	25004500500-2093	-	○	
	5	0,5	0,55	93 AU 2093 / N3101	LSU	25004500500B-2093	-	●	
	5	0,563	0,593	92 AU 9250	D 300	560G01252000A	-	●	
	5	0,563	0,593	92 AU 9250	RO	560001252000A	-	●	
	5	0,563	0,593	92 AU 9250	SYM	560005350000A	-	●	
	5	0,563	0,618	93 AU 2093 / N3101	LSU	25004500562B-2093	-	○	
	5	0,625	0,688	93 AU 2093 / N3101	LSU	25004500625B-2093	-	○	
	5,125	0,313	0,344	93 AU 2093 / N3101	LSU	31204500-2093	-	○	
	5,125	0,375	0,406	92 AU 9250	RO	001254000A	-	●	
	5,125	0,375	0,406	92 AU 9250	SYM	005353000A	-	○	
4,5	5,125	0,5	0,531	92 AU 9250	RO	001253000A	-	○	
	5,125	0,5	0,55	93 AU 2093 / N3101	LSU	31204500500B-2093	-	○	
	5,125	0,625	0,656	92 AU 9250	SYM	005351000A	-	○	
	5,125	0,625	0,688	93 AU 2093 / N3101	LSU	31204500625B-2093	-	○	
	5,25	0,375	0,413	93 AU 2093 / N3101	LSU	37504500-2093	-	○	
	5,25	0,375	0,413	93 AU 2093 / N3101	LSU	37504500SQB-2093	-	○	
	5,25	0,5	0,531	92 AU 9250	RO	001256000A	-	●	
	5,25	0,5	0,531	92 AU 9250	SYM	560005355000A	-	●	
	5,25	0,625	0,656	94 AU 30000	D 300	560G01255000B	-	●	
	5,25	0,625	0,656	92 AU 9250	RO	001255000A	-	●	
	5,25	0,625	0,656	92 AU 9250	SYM	005354000A	-	●	
	5,25	0,625	0,688	93 AU 2093 / N3101	LSU	37504500625B-2093	-	○	
	5,5	0,5	0,55	93 AU 2093 / N3101	LSU	50004500-2093	-	○	
	5,5	0,75	0,825	93 AU 2093 / N3101	LSU	50004500750B-2093	-	○	
	5	0,375	0,413	93 AU 2093 / N3101	LSU	18704625375B-2093	-	○	
4,625	5,125	0,563	0,618	93 AU 2093 / N3101	LSU	25004625562B-2093	-	○	
	5,25	0,625	0,688	93 AU 2093 / N3101	LSU	31204625625B-2093	-	○	
	5,375	0,5	0,531	92 AU 9250	RO	560001258000A	-	○	
	5,375	0,5	0,531	92 AU 9250	SYM	005361000A	-	●	
	5,375	0,625	0,688	93 AU 2093 / N3101	LSU	37504625625B-2093	-	○	
	5,125	0,188	0,207	93 AU 2093 / N3101	LSU	18704750-2093	-	○	
	5,25	0,25	0,275	93 AU 2093 / N3101	LSU	25004750-2093	-	○	
	5,25	0,375	0,406	92 AU 9250	SYM	560005362I00A	-	●	
	5,25	0,375	0,413	93 AU 2093 / N3101	LSU	25004750375B-2093	-	○	
	5,25	0,563	0,593	92 AU 9250	D 300	560G01259000A	-	●	
	5,25	0,563	0,593	92 AU 9250	RO	001259000A	-	●	
	5,25	0,563	0,593	92 AU 9250	SYM	560005362000A	-	●	
	5,25	0,563	0,618	93 AU 2093 / N3101	LSU	25004750562-2093	-	○	
4,75	5,25	0,625	0,688	93 AU 2093 / N3101	LSU	25004750625B-2093	-	○	
	5,375	0,375	0,406	92 AU 9250	SYM	005365000A	-	○	
	5,375	0,5	0,531	92 AU 9250	SYM	005364000A	-	○	
	5,375	0,625	0,656	92 AU 9250	SYM	005363000A	-	○	
	5,5	0,375	0,413	93 AU 2093 / N3101	LSU	37504750-2093	-	○	
	5,5	0,375	0,413	93 AU 2093 / N3101	LSU	37504750SQB-2093	-	○	
	5,5	0,39	0,406	92 AU 9250	RO	001260I00A	-	●	
	5,5	0,5	0,531	92 AU 9250	RO	001261000A	-	○	
	5,5	0,5	0,531	92 AU 9250	SYM	005367000A	-	●	

d [inch]	D [inch]	H [inch]	L [inch]	Material	Design	Part No.	PU ¹⁾	US	EU	
4,75	5,5	0,5	0,55	93 AU 2093 / N3101	LSU	37504750500-2093	-	○		
	5,5	0,5	0,55	93 AU 2093 / N3101	LSU	37504750500B-2093	-	○		
	5,5	0,625	0,656	92 AU 9250	RO	001260000A	-	●		
	5,5	0,625	0,656	92 AU 9250	SYM	005366000A	-	●		
	5,5	0,625	0,688	93 AU 2093 / N3101	LSU	37504750625-2093	-	○		
	5,5	0,625	0,688	93 AU 2093 / N3101	LSU	37504750625B-2093	-	●		
	5,75	0,5	0,55	93 AU 2093 / N3101	LSU	50004750-2093	-	●		
	6	0,625	0,688	93 AU 2093 / N3101	LSU	625047501000-2093	-	○		
4,875	5,375	0,25	0,275	93 AU 2093 / N3101	LSU	25004875-2093	-	○		
	5,375	0,563	0,618	93 AU 2093 / N3101	LSU	25004875562B-2093	-	○		
	5,5	0,313	0,344	93 AU 2093 / N3101	LSU	31204875-2093	-	○		
	5,5	0,375	0,406	92 AU 9250	SYM	005371000A	-	●		
	5,5	0,5	0,531	92 AU 9250	SYM	005370000A	-	○		
	5,625	0,5	0,531	92 AU 9250	RO	001263000A	-	●		
	5,625	0,5	0,531	92 AU 9250	SYM	005373000A	-	○		
	5,625	0,625	0,656	92 AU 9250	RO	560001262000A	-	○		
5	5,625	0,625	0,688	93 AU 2093 / N3101	LSU	37504875625B-2093	-	○		
	5,375	0,188	0,207	93 AU 2093 / N3101	LSU	18705000-2093	-	○		
	5,375	0,375	0,413	93 AU 2093 / N3101	LSU	18705000375B-2093	-	○		
	5,5	0,25	0,275	93 AU 2093 / N3101	LSU	25005000-2093	-	●		
	5,5	0,25	0,275	93 AU 2093 / N3101	LSU	25005000SQB-2093	-	●		
	5,5	0,375	0,413	93 AU 2093 / N3101	LSU	25005000375-2093	-	●		
	5,5	0,375	0,413	93 AU 2093 / N3101	LSU	25005000375B-2093	-	●		
	5,5	0,5	0,55	93 AU 2093 / N3101	LSU	25005000500B-2093	-	○		
	5,5	0,563	0,618	93 AU 2093 / N3101	LSU	25005000562B-2093	-	○		
	5,563	0,344	0,376	92 AU 9250	D 300	560G01418000A	-	●		
	5,625	0,313	0,344	93 AU 2093 / N3101	LSU	31205000-2093	-	○		
	5,625	0,375	0,406	92 AU 9250	RO	001266000A	-	●		
	5,75	0,375	0,413	93 AU 2093 / N3101	LSU	37505000-2093	-	○		
	5,75	0,375	0,413	93 AU 2093 / N3101	LSU	37505000SQB-2093	-	○		
	5,75	0,5	0,531	92 AU 9250	D 300	560G01268000A	-	●		
	5,75	0,5	0,531	92 AU 9250	RO	001268000A	-	○		
	5,75	0,5	0,55	93 AU 2093 / N3101	LSU	37505000500B-2093	-	○		
	5,75	0,625	0,656	94 AU 30000	D 300	560G01267000B	-	●		
	5,75	0,625	0,656	92 AU 9250	RO	560001267000A	-	●		
	5,75	0,625	0,688	93 AU 2093 / N3101	LSU	37505000625-2093	-	○		
5,75	0,625	0,688	93 AU 2093 / N3101	LSU	37505000625B-2093	-	○			
5,125	6	0,5	0,55	93 AU 2093 / N3101	LSU	50005000-2093	-	●		
	6	0,5	0,55	93 AU 2093 / N3101	LSU	50005000SQB-2093	-	○		
	6	0,75	0,825	93 AU 2093 / N3101	LSU	50005000750B-2093	-	●		
	6,25	0,625	0,688	93 AU 2093 / N3101	LSU	62505000-2093	-	○		
	5,75	0,313	0,344	93 AU 2093 / N3101	LSU	31205125-2093	-	○		
	5,75	0,375	0,406	92 AU 9250	SYM	005383000A	-	○		
	5,75	0,5	0,531	92 AU 9250	SYM	005382000A	-	○		
	5,875	0,375	0,413	93 AU 2093 / N3101	LSU	37505125-2093	-	○		
	5,75	0,25	0,275	93 AU 2093 / N3101	LSU	25005250-2093	-	○		
	5,75	0,375	0,413	93 AU 2093 / N3101	LSU	25005250375B-2093	-	●		
	5,25	5,75	0,563	0,593	92 AU 9250	RO	001269000A	-	●	
	5,75	0,563	0,593	92 AU 9250	SYM	005386000A	-	●		
5,75	0,563	0,618	93 AU 2093 / N3101	LSU	25005250562-2093	-	○			

d [inch]	D [inch]	H [inch]	L [inch]	Material	Design	Part No.	PU ¹⁾	US	EU
5,25	5,75	0,563	0,618	93 AU 2093 / N3101	LSU	25005250562B-2093	-	○	
	5,875	0,375	0,406	92 AU 9250	SYM	005389000A	-	○	
	5,875	0,5	0,531	92 AU 9250	SYM	005388000A	-	○	
	6	0,375	0,406	92 AU 9250	SYM	005390100A	-	●	
	6	0,375	0,406	92 AU 9250	SYM	005391100A	-	○	
	6	0,375	0,413	93 AU 2093 / N3101	LSU	37505250-2093	-	○	
	6	0,375	0,413	93 AU 2093 / N3101	LSU	37505250SQB-2093	-	●	
	6	0,5	0,531	92 AU 9250	SYM	005391000A	-	●	
	6	0,5	0,55	93 AU 2093 / N3101	LSU	37505250500-2093	-	●	
	6	0,5	0,55	93 AU 2093 / N3101	LSU	37505250500B-2093	-	○	
	6	0,625	0,656	92 AU 9250	RO	560001272000A	-	●	
	6	0,625	0,656	92 AU 9250	SYM	005390000A	-	●	
	6	0,625	0,688	93 AU 2093 / N3101	LSU	37505250625-2093	-	●	
	6	0,625	0,688	93 AU 2093 / N3101	LSU	37505250625B-2093	-	●	
5,375	5,875	0,25	0,275	93 AU 2093 / N3101	LSU	25005375-2093	-	○	
	5,875	0,375	0,406	92 AU 9250	SYM	005392100A	-	○	
	6	0,313	0,344	93 AU 2093 / N3101	LSU	31205375-2093	-	●	
	6	0,313	0,344	93 AU 2093 / N3101	LSU	31205375SQB-2093	-	○	
	6	0,375	0,406	92 AU 9250	SYM	005395000A	-	●	
	6	0,5	0,531	92 AU 9250	SYM	005394000A	-	○	
	6	0,625	0,656	92 AU 9250	SYM	005393000A	-	●	
	6	0,625	0,688	93 AU 2093 / N3101	LSU	31205375625-2093	-	○	
	6,125	0,5	0,531	92 AU 9250	SYM	005397000A	-	○	
6,125	0,625	0,656	92 AU 9250	RO	560001276000A	-	○		
5,5	5,875	0,375	0,413	93 AU 2093 / N3101	LSU	18705500375B-2093	-	●	
	6	0,25	0,275	93 AU 2093 / N3101	LSU	25005500-2093	-	○	
	6	0,25	0,275	93 AU 2093 / N3101	LSU	25005500SQB-2093	-	○	
	6	0,375	0,413	93 AU 2093 / N3101	LSU	25005500375-2093	-	○	
	6	0,375	0,413	93 AU 2093 / N3101	LSU	25005500375B-2093	-	●	
	6	0,39	0,406	92 AU 9250	RO	560001278100A	-	○	
	6	0,5	0,55	93 AU 2093 / N3101	LSU	25005500500-2093	-	○	
	6	0,563	0,593	92 AU 9250	D 300	560G01278000A	-	●	
	6	0,563	0,593	92 AU 9250	RO	560001278000A	-	○	
	6	0,563	0,618	93 AU 2093 / N3101	LSU	25005500562-2093	-	○	
	6	0,563	0,618	93 AU 2093 / N3101	LSU	25005500562B-2093	-	○	
	6,125	0,313	0,344	93 AU 2093 / N3101	LSU	31205500-2093	-	○	
	6,125	0,375	0,406	92 AU 9250	D 300	560G01421000A	-	○	
	6,125	0,375	0,406	92 AU 9250	RO	560001280000A	-	●	
	6,125	0,375	0,406	92 AU 9250	SYM	005400000A	-	○	
	6,125	0,375	0,413	93 AU 2093 / N3101	LSU	31205500375-2093	-	○	
	6,125	0,5	0,531	92 AU 9250	RO	001279000A	-	○	
	6,125	0,625	0,656	92 AU 9250	SYM	005398000A	-	○	
	6,25	0,375	0,406	92 AU 9250	SYM	005402100A	-	●	
	6,25	0,375	0,413	93 AU 2093 / N3101	LSU	37505500-2093	-	○	
	6,25	0,5	0,531	92 AU 9250	RO	001282000A	-	○	
6,25	0,5	0,531	92 AU 9250	SYM	005402000A	-	●		
6,25	0,625	0,656	92 AU 9250	RO	001281000A	-	●		
6,5	0,5	0,55	93 AU 2093 / N3101	LSU	50005500-2093	-	○		
6,5	0,75	0,825	93 AU 2093 / N3101	LSU	50005500750B-2093	-	○		
5,625	6,125	0,25	0,275	93 AU 2093 / N3101	LSU	25005625-2093	-	○	

d [inch]	D [inch]	H [inch]	L [inch]	Material	Design	Part No.	PU ¹⁾	US	EU
5,625	6,125	0,375	0,406	92 AU 9250	SYM	005403100A	-	○	
	6,125	0,563	0,618	93 AU 2093 / N3101	LSU	25005625562B-2093	-	○	
	6,25	0,5	0,531	92 AU 9250	SYM	005405000A	-	●	
	6,25	0,625	0,656	92 AU 9250	SYM	005404000A	-	○	
	6,375	0,625	0,656	92 AU 9250	SYM	005407000A	-	○	
5,75	6,25	0,25	0,275	93 AU 2093 / N3101	LSU	25005750-2093	-	○	
	6,25	0,563	0,593	92 AU 9250	RO	001287000A	-	○	
	6,25	0,625	0,656	92 AU 9250	SYM	560005522000A	-	○	
	6,5	0,375	0,413	93 AU 2093 / N3101	LSU	37505750-2093	-	○	
	6,5	0,5	0,531	92 AU 9250	SYM	005413000A	-	●	
	6,5	0,625	0,656	92 AU 9250	RO	001288000A	-	●	
	6,5	0,625	0,656	92 AU 9250	SYM	005412000A	-	●	
	6,5	0,625	0,688	93 AU 2093 / N3101	LSU	37505750625B-2093	-	○	
	6,75	0,5	0,55	93 AU 2093 / N3101	LSU	50005750-2093	-	○	
	6,75	0,75	0,825	93 AU 2093 / N3101	LSU	50005750750B-2093	-	○	
5,875	7	1	1,1	93 AU 2093 / N3101	LSU	625057501000B-2093	-	○	
5,875	6,5	0,375	0,406	92 AU 9250	SYM	005417000A	-	○	
6	6,5	0,25	0,275	93 AU 2093 / N3101	LSU	25006000-2093	-	●	
	6,5	0,25	0,275	93 AU 2093 / N3101	LSU	25006000SQB-2093	-	○	
	6,5	0,375	0,406	92 AU 9250	SYM	005420100A	-	●	
	6,5	0,375	0,413	93 AU 2093 / N3101	LSU	25006000375B-2093	-	○	
	6,5	0,45	0,495	93 AU 2093 / N3101	LSU	25006000450-2093	-	○	
	6,5	0,563	0,593	92 AU 9250	RO	001292000A	-	●	
	6,5	0,563	0,593	92 AU 9250	SYM	005420000A	-	●	
	6,5	0,563	0,618	93 AU 2093 / N3101	LSU	25006000562B-2093	-	○	
	6,625	0,313	0,344	93 AU 2093 / N3101	LSU	31206000-2093	-	○	
	6,75	0,5	0,531	92 AU 9250	RO	001294000A	-	●	
	6,75	0,625	0,656	92 AU 9250	RO	560001293000A	-	●	
	6,75	0,625	0,688	93 AU 2093 / N3101	LSU	37506000625B-2093	-	●	
	7	0,5	0,55	93 AU 2093 / N3101	LSU	50006000-2093	-	○	
	7	0,5	0,55	93 AU 2093 / N3101	LSU	50006000SQB-2093	-	○	
	7	0,625	0,656	92 AU 9250	SYM	005422000A	-	●	
	7	0,75	0,781	92 AU 9250	SYM	005421000A	-	●	
7	0,75	0,825	93 AU 2093 / N3101	LSU	50006000750B-2093	-	○		
6,25	6,75	0,25	0,275	93 AU 2093 / N3101	LSU	25006250-2093	-	○	
	6,75	0,5	0,531	92 AU 9250	SYM	005423M00A	-	○	
	6,75	0,563	0,593	92 AU 9250	SYM	005423000A	-	○	
	7	0,5	0,531	92 AU 9250	SYM	005425000A	-	●	
	7	0,5	0,55	93 AU 2093 / N3101	LSU	37506250500B-2093	-	○	
	7	0,625	0,656	92 AU 9250	RO	001295000A	-	●	
	7	0,625	0,656	92 AU 9250	SYM	005424000A	-	●	
	7	0,625	0,688	93 AU 2093 / N3101	LSU	37506250625B-2093	-	○	
6,375	7	0,313	0,344	93 AU 2093 / N3101	LSU	31206375-2093	-	○	
6,5	7	0,25	0,275	93 AU 2093 / N3101	LSU	25006500-2093	-	●	
	7	0,25	0,275	93 AU 2093 / N3101	LSU	25006500SQB-2093	-	○	
	7	0,375	0,406	92 AU 9250	SYM	005428100A	-	●	
	7	0,375	0,413	93 AU 2093 / N3101	LSU	25006500375B-2093	-	○	
	7	0,5	0,531	92 AU 9250	SYM	005428M00A	-	●	
	7	0,563	0,593	92 AU 9250	SYM	005428000A	-	○	
	7	0,563	0,593	92 AU 9250	SYM	005428000A	-	○	

d [inch]	D [inch]	H [inch]	L [inch]	Material	Design	Part No.	PU ¹⁾	US	EU
6,5	7,25	0,375	0,413	93 AU 2093 / N3101	LSU	37506500-2093	-	○	
	7,25	0,5	0,531	92 AU 9250	RO	560001299000A	-	●	
	7,25	0,5	0,531	92 AU 9250	SYM	005430000A	-	○	
	7,25	0,5	0,55	93 AU 2093 / N3101	LSU	37506500500-2093	-	○	
	7,25	0,625	0,656	92 AU 9250	RO	001298000A	-	●	
	7,25	0,625	0,656	92 AU 9250	SYM	005429000A	-	●	
	7,25	0,625	0,688	93 AU 2093 / N3101	LSU	37506500625B-2093	-	●	
	7,5	0,5	0,55	93 AU 2093 / N3101	LSU	50006500-2093	-	○	
	7,5	0,75	0,781	92 AU 9250	RO	001300000A	-	○	
	7,5	0,75	0,781	92 AU 9250	SYM	005431000A	-	○	
6,625	7,5	0,75	0,825	93 AU 2093 / N3101	LSU	50006500750B-2093	-	●	
	7,25	0,313	0,344	93 AU 2093 / N3101	LSU	31206625-2093	-	○	
6,75	7,25	0,25	0,275	93 AU 2093 / N3101	LSU	25006750-2093	-	○	
	7,25	0,563	0,593	92 AU 9250	SYM	005433000A	-	○	
	7,25	0,563	0,618	93 AU 2093 / N3101	LSU	25006750562B-2093	-	○	
	7,375	0,625	0,688	93 AU 2093 / N3101	LSU	31206750625B-2093	-	○	
	7,5	0,5	0,531	92 AU 9250	SYM	005435000A	-	●	
	7,75	0,75	0,825	93 AU 2093 / N3101	LSU	50006750750B-2093	-	○	
7	7,5	0,563	0,593	92 AU 9250	SYM	005438000A	-	●	
	7,5	0,563	0,618	93 AU 2093 / N3101	LSU	25007000562B-2093	-	○	
	7,625	0,375	0,406	92 AU 9250	D 300	560G01422000A	-	○	
	7,75	0,5	0,531	92 AU 9250	RO	001308000A	-	●	
	7,75	0,5	0,531	92 AU 9250	SYM	005440000A	-	●	
	7,75	0,625	0,656	92 AU 9250	RO	001307000A	-	●	
	7,75	0,625	0,656	92 AU 9250	SYM	005439000A	-	●	
	7,75	0,625	0,688	93 AU 2093 / N3101	LSU	37507000625B-2093	-	○	
	8	0,5	0,55	93 AU 2093 / N3101	LSU	50007000-2093	-	○	
	8	0,625	0,656	92 AU 9250	RO	001310000A	-	○	
	8	0,625	0,656	92 AU 9250	SYM	005442000A	-	○	
	8	0,75	0,781	92 AU 9250	SYM	005441000A	-	○	
	8	0,75	0,825	93 AU 2093 / N3101	LSU	50007000750-2093	-	●	
	8	0,75	0,825	93 AU 2093 / N3101	LSU	50007000750B-2093	-	○	
7,25	7,75	0,563	0,593	92 AU 9250	SYM	005443000A	-	○	
	8	0,375	0,413	93 AU 2093 / N3101	LSU	37507250-2093	-	○	
	8	0,5	0,531	92 AU 9250	SYM	005445000A	-	●	
	8	0,5	0,55	93 AU 2093 / N3101	LSU	37507250500-2093	-	○	
	8	0,625	0,656	92 AU 9250	RO	001311000A	-	●	
	8	0,625	0,656	92 AU 9250	SYM	005444000A	-	○	
	8	0,625	0,688	93 AU 2093 / N3101	LSU	37507250625B-2093	-	○	
7,375	8	0,313	0,344	93 AU 2093 / N3101	LSU	31207375-2093	-	○	
7,5	8	0,25	0,275	93 AU 2093 / N3101	LSU	25007500-2093	-	●	
	8	0,25	0,275	93 AU 2093 / N3101	LSU	25007500SQB-2093	-	○	
	8	0,375	0,413	93 AU 2093 / N3101	LSU	25007500375B-2093	-	●	
	8	0,563	0,593	92 AU 9250	SYM	005448000A	-	○	
	8	0,563	0,618	93 AU 2093 / N3101	LSU	25007500562-2093	-	●	
	8	0,563	0,618	93 AU 2093 / N3101	LSU	25007500562B-2093	-	○	
	8,25	0,375	0,413	93 AU 2093 / N3101	LSU	37507500-2093	-	○	
	8,25	0,625	0,656	92 AU 9250	RO	001315000A	-	○	
	8,25	0,625	0,688	93 AU 2093 / N3101	LSU	37507500625B-2093	-	○	
	8,5	0,75	0,781	92 AU 9250	SYM	005451000A	-	●	

d [inch]	D [inch]	H [inch]	L [inch]	Material	Design	Part No.	PU ¹⁾	US	EU
7,75	8,25	0,563	0,618	93 AU 2093 / N3101	LSU	25007750562B-2093	-	○	
	8,5	0,375	0,413	93 AU 2093 / N3101	LSU	37507750-2093	-	○	
	8,5	0,5	0,531	92 AU 9250	SYM	005455000A	-	●	
	8,75	0,75	0,781	92 AU 9250	SYM	005456000A	-	○	
7,875	8,5	0,625	0,688	93 AU 2093 / N3101	LSU	31207875625B-2093	-	○	
	8,5	0,25	0,275	93 AU 2093 / N3101	LSU	25008000-2093	-	○	
	8,5	0,25	0,275	93 AU 2093 / N3101	LSU	25008000SQB-2093	-	○	
	8,5	0,375	0,413	93 AU 2093 / N3101	LSU	25008000375B-2093	-	○	
	8,5	0,563	0,593	92 AU 9250	SYM	005458000A	-	○	
	8,5	0,563	0,618	93 AU 2093 / N3101	LSU	25008000562B-2093	-	○	
	8,75	0,5	0,531	92 AU 9250	SYM	005460000A	-	●	
	8,75	0,5	0,55	93 AU 2093 / N3101	LSU	37508000500B-2093	-	○	
	8,75	0,625	0,656	92 AU 9250	D 300	560G01420000A	-	○	
	8,75	0,625	0,688	93 AU 2093 / N3101	LSU	37508000625B-2093	-	○	
8	9	0,5	0,55	93 AU 2093 / N3101	LSU	50008000-2093	-	○	
	9	0,5	0,55	93 AU 2093 / N3101	LSU	50008000SQB-2093	-	○	
	9	0,625	0,656	92 AU 9250	SYM	005462000A	-	●	
	9	0,75	0,781	92 AU 9250	SYM	005461000A	-	●	
	9	0,75	0,825	93 AU 2093 / N3101	LSU	50008000750B-2093	-	○	
	9	0,5	0,531	92 AU 9250	SYM	005465000A	-	●	
	9	0,625	0,688	93 AU 2093 / N3101	LSU	37508250625B-2093	-	○	
	9,25	0,5	0,55	93 AU 2093 / N3101	LSU	50008250-2093	-	○	
	9	0,25	0,275	93 AU 2093 / N3101	LSU	25008500-2093	-	○	
	9	0,375	0,406	92 AU 9250	SYM	005468100A	-	○	
8,5	9,25	0,375	0,413	93 AU 2093 / N3101	LSU	37508500-2093	-	○	
	9,25	0,625	0,656	92 AU 9250	SYM	005469000A	-	○	
	9,25	0,625	0,688	93 AU 2093 / N3101	LSU	37508500625B-2093	-	○	
	9,5	0,594	0,625	92 AU 9250	SYM	005471Q00A	-	○	
	9,5	0,75	0,825	93 AU 2093 / N3101	LSU	50008500750B-2093	-	○	
	9,25	0,25	0,275	93 AU 2093 / N3101	LSU	25008750-2093	-	○	
8,75	9,75	0,75	0,825	93 AU 2093 / N3101	LSU	50008750750B-2093	-	○	
	9,5	0,25	0,275	93 AU 2093 / N3101	LSU	25009000-2093	-	○	
9	9,75	0,375	0,413	93 AU 2093 / N3101	LSU	37509000-2093	-	○	
	9,75	0,625	0,688	93 AU 2093 / N3101	LSU	37509000625B-2093	-	○	
	10	0,5	0,55	93 AU 2093 / N3101	LSU	50009000-2093	-	○	
	10	0,59	0,625	92 AU 9250	SYM	005487Q00A	-	○	
	10	0,625	0,656	92 AU 9250	RO	001326000A	-	○	
	10	0,625	0,656	92 AU 9250	SYM	005481000A	-	●	
	10	0,75	0,781	92 AU 9250	SYM	005480000A	-	○	
	10	0,75	0,825	93 AU 2093 / N3101	LSU	50009000750-2093	-	●	
	10	0,75	0,825	93 AU 2093 / N3101	LSU	50009000750B-2093	-	●	
	9,75	0,25	0,275	93 AU 2093 / N3101	LSU	25009250-2093	-	○	
9,25	10	0,375	0,413	93 AU 2093 / N3101	LSU	37509250-2093	-	●	
	10	0,5	0,55	93 AU 2093 / N3101	LSU	37509250500B-2093	-	○	
	10	0,625	0,688	93 AU 2093 / N3101	LSU	37509250625-2093	-	○	
	10	0,625	0,688	93 AU 2093 / N3101	LSU	37509250625B-2093	-	●	
9,375	10	0,625	0,688	93 AU 2093 / N3101	LSU	31209375625B-2093	-	○	
9,5	10	0,25	0,275	93 AU 2093 / N3101	LSU	25009500-2093	-	●	
	10	0,563	0,618	93 AU 2093 / N3101	LSU	25009500562-2093	-	○	
	10	0,563	0,618	93 AU 2093 / N3101	LSU	25009500562B-2093	-	○	

d [inch]	D [inch]	H [inch]	L [inch]	Material	Design	Part No.	PU ¹⁾	US	EU
9,5	10,25	0,625	0,688	93 AU 2093 / N3101	LSU	37509500625B-2093	-	○	
	10,5	0,625	0,656	92 AU 9250	RO	001328000A	-	○	
	10,5	0,75	0,825	93 AU 2093 / N3101	LSU	50009500750B-2093	-	○	
10	10,5	0,563	0,618	93 AU 2093 / N3101	LSU	25010000562B-2093	-	●	
	11	0,625	0,656	92 AU 9250	RO	001330000A	-	●	
	11	0,625	0,656	92 AU 9250	SYM	005488000A	-	○	
	11	0,75	0,781	92 AU 9250	RO	001329000A	-	●	
	11	0,75	0,781	92 AU 9250	SYM	005487000A	-	●	
	11	0,75	0,825	93 AU 2093 / N3101	LSU	50010000750B-2093	-	●	
11	11,5	0,25	0,275	93 AU 2093 / N3101	LSU	25011000-2093	-	○	
	12	0,5	0,55	93 AU 2093 / N3101	LSU	50011000-2093	-	●	
	12	0,59	0,625	92 AU 9250	SYM	005489000A	-	●	
	12	0,75	0,781	92 AU 9250	SYM	005489000A	-	●	
	12	0,75	0,825	93 AU 2093 / N3101	LSU	50011000750B-2093	-	○	
11,25	12	0,375	0,413	93 AU 2093 / N3101	LSU	37511250-2093	-	●	
	12	0,625	0,688	93 AU 2093 / N3101	LSU	37511250625-2093	-	○	

MONTAGEHILFE | MONTAJ YARDIM POMOC MONTAŻOWA | РУКОВОДСТВО ПО МОНТАЖУ

DE STANGENDICHTUNGEN

Was nützt die beste Dichtung, wenn sie nicht richtig eingebaut oder beim Einbau beschädigt wird? Damit dies nicht passiert, stellt Ihnen Freudenberg Sealing Technologies eine maßgeschneiderte Palette von Montagewerkzeugen zur Verfügung. Die einwandfreie Montage ist entscheidend für die Leistungsfähigkeit und Standzeit einer Dichtung und stellt damit ein wesentliches Qualitätsmerkmal dar. Mit den Einbauhilfen von Freudenberg Sealing Technologies

- vermeiden Sie grundlegende Einbaufehler,
- vermeiden Sie Beschädigungen der Dichtkante bei der Montage,
- erhöhen Sie die Standzeit der Dichtung,
- sparen Sie Zeit und Kosten.

Für Stangendichtungen bieten sich je nach Werkstoff unterschiedliche Montagewerkzeuge an.

1. Stangendichtungen aus Elastomer

1A. Der Allrounder unter den Einbauhilfen ist die **Montagezange**. Mit ihr gelingt der Einbau kleiner und großer Dichtungsabmessungen in axial zugängliche Einbauräume schnell und sicher im Handumdrehen.

Hierzu:

- Die Zangengriffe vollständig öffnen und die Dichtung über die Bolzen aufnehmen (Einbaurichtung beachten!).
- Die Zangengriffe auf Anschlag schließen: Die Dichtung verformt sich dadurch nierenförmig.
- Die Dichtung in die Einbaunut einführen.
- Den Zangengriff lösen und die Zange entfernen. Die Dichtung schnappt nun in der Regel selbstständig in die Nut ein. Bei Bedarf manuell mit dem Finger nachhelfen.

1B. Ebenfalls bewährt hat sich der Einbau von Stangendichtungen mittels **Pusher, Konushülse und Gegenhalter**.

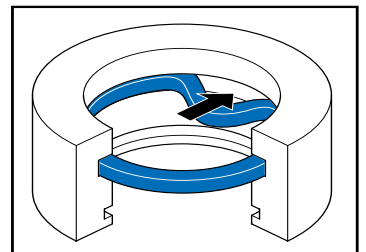
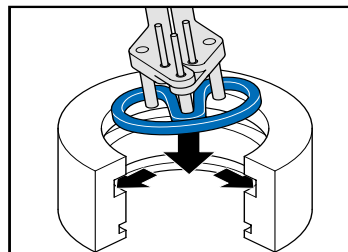
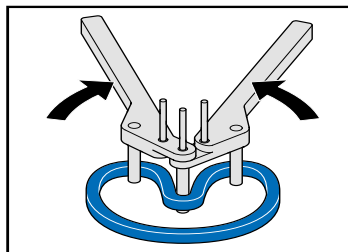
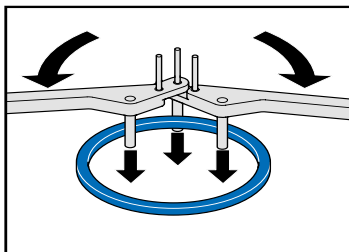

1A. Einbau mit Montagezange | Montaj pensesi ile montaj | Instalacja za pomocą szczypiec | Установка с помощью монтажного инструмента

Hierzu:

- Den Gegenhalter in den Einbauraum einsetzen.
- Den Konus auf den Einbauraum aufsetzen.
- Die Stangendichtung einfügen.
- Die Dichtung mit dem Pusher eindrücken.

2. Stangendichtungen aus PTFE

Stangendichtungen aus PTFE bestehen in der Regel aus zwei Komponenten: einem O-Ring und einem Gleitring. Beide lassen sich in nur drei Schritten funktionsfertig einbauen. Hierzu bieten sich als Hilfsmittel Spreizdorn, Konushülse, Kalibrierdorn, Gegenhalter sowie ein Haltewerkzeug (nur für die O-Ring-Montage) an.

Schritt 1: O-Ring-Montage

- Den Zylinder auf dem Gegenhalter fixieren.
- Die Konushülse aufsetzen.
- Den O-Ring zusammendrücken und in das Haltewerkzeug einführen.
- Den O-Ring in die Nut einführen und aus dem Haltewerkzeug drücken.
- Mit dem Haltewerkzeug den noch aus der Nut herausragenden Teil des O-Rings in die Nut eindrücken.

Schritt 2: Gleitring-Montage

- Den Zylinder auf dem Gegenhalter fixieren.
- Die Konushülse aufsetzen.
- Den Kegel vom Spreizdorn entfernen und den Gleitring in die Nut des Spreizdorns einlegen.
- Den Spreizdorn in die Konushülse einfügen und gleichmäßig durch die Konushülse drücken.
- Den Spreizdorn aus der Konushülse ziehen.
- Den Zylinder vom Gegenhalter entfernen.

Schritt 3: Kalibrieren

- Den eingöhlten Kalibrierdorn durch den vormontierten Gleitring schieben.

TR ROD SIZDIRMAZLIK ELEMANLARI

Doğru montaj yapılmayan ve ya montaj sırasında hasar gören sızdırmazlık elemanları en iyi sızdırmazlık elemanları olsa bile neye yarar? Bunun olmaması için Freudenberg Sealing Technologies size özel hazırlanmış montaj takımları sunmaktadır. Bir sızdırmazlık elemanının performansı ve dayanım süresi için kusursuz montaj çok önemlidir ve önemli bir kalite özelliğidir. Freudenberg Sealing Technologies montaj yardımcıları ile:

- temel montaj hatalarından kaçınabilirsiniz.
- montaj sırasında sızdırmazlık dudağına zarar vermeyi önlersiniz.
- sızdırmazlık elemanının dayanım süresini artırarak
- zamandan ve maliyetten tasarruf etmiş olursunuz.

Malzemeye bağlı olarak rod sızdırmazlık elemanları için değişik montaj aletleri sunulmaktadır.

1. Elastomer rod sızdırmazlık elemanları

1A. Çok amaçlı montaj yardımcılarında birisi montaj pensesidir. Bununla küçük ve büyük sızdırmazlık elemanlarını bile aksenel erişimli montaj alanlarında hızlı ve güvenli olarak monte etmek mümkündür.

Bunun için:

- Pensenin ağzını açınız ve sızdırmazlık elemanını pensenin pimleriyle kavrayınız (montaj yönüne dikkat ediniz!).
- Pensenin saplarını bir miktar sıkınız: Sızdırmazlık elemanı bu sırada böbrek şekli alır.
- Sızdırmazlık elemanını yuvaya geçiriniz.
- Pensayı açınız ve pensayı çıkartınız. Artık sızdırmazlık elemanı kendiliğinden yuvaya oturmuş olur. Gerekirse el yardımı ile sızdırmazlık elemanının yuvaya tam oturmasına yardımcı olun.

1B. Ayrıca rod sızdırmazlık elemanı itici, konik kovan ve karşı tutucu ile de monte edilebilmektedir.

Bunun için:

- Karşı tutucuyu montaj alanına konumlandırınız.
- Koniye montaj alanına geçiriniz.
- Sızdırmazlık elemanını takınız.
- Sızdırmazlık elemanını itici ile içe bastırınız.

2. PTFE Rod sızdırmazlık elemanları

PTFE rod sızdırmazlık elemanları prensip olarak iki bileşenden oluşmaktadır: bir O-Ring ve bir elastomer kayıcı ring. Her ikisi de sadece üç adımda kullanıma hazır halde montajı yapılabilir. Bunun için uygun yardımcı araçlar genişletme aparatı, konik kovan, kalibrasyon zımbası, karşı tutucu ve tutma takımı (sadece O-Ring montajı için).

Adım 1: O-ring montajı

- Silindiri, karşı tutucunun üzerine sabitleyiniz.
- Konik kovana geçiriniz.
- O-ring'i bastırınız ve tutma takımına geçiriniz.
- O ring'i yuvaya sokunuz ve tutma takımından dışarıya bastırınız.
- Tutma takımı ile yuvaya dışarıya taşan O-Ring kısmını yuvanın içerisine bastırınız.

Adım 2: Elastomer kayıcı ring montajı

- Silindiri, karşı tutucunun üzerine sabitleyiniz.
- Konik kovana geçiriniz.
- Genişletme aparatının konisini çıkarınız ve kayıcı ring'i genişletme aparatının yuvasına takınız.
- Germe zımbasını konik kovana geçiriniz ve dengeli olarak konik kovandan bastırarak geçiriniz.
- Germe zımbasını konik kovandan çekiniz.
- Karşı tutucudaki silindiri çıkarınız.

Adım 3: Kalibrasyon

- Yağlanmış kalibrasyon pimini, önceden monte edilen kayar halkadan iterek geçiriniz.

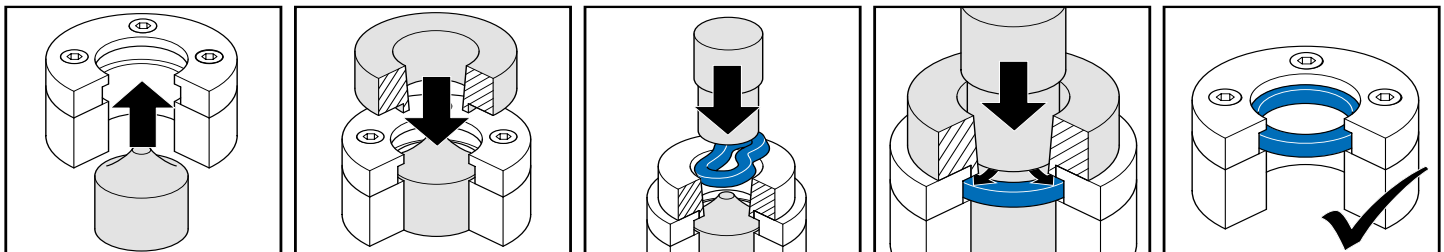

1B. Einbau mit Pusher, Konushülse und Gegenhalter | İtici, konik kol ve tutucu ile montaj |

Instalacja za pomocą popychacza, rękawa stożkowego, blokad | Установка с помощью толкателя, конусной втулки и контрупора

PL USZCZELNIENIA TŁOCZYSKA

Cóż jest warta nawet najlepsza uszczelka, jeśli nie zostanie prawidłowo zainstalowana lub ulegnie uszkodzeniu podczas montażu? Aby tak się nie stało, firma Freudenberg Sealing Technologies udostępnia Państwu specjalistyczny zestaw narzędzi montażowych. Prawidłowy montaż jest kluczowym czynnikiem wpływającym na funkcjonowanie uszczelniania oraz jego długą żywotność. Dzięki narzędziom do montażu oferowanym przez firmę Freudenberg Sealing Technologies

- unika się podstawowych błędów montażowych,
- unika się uszkodzenia krawędzi uszczelniających podczas montażu,
- wydłuża się żywotność uszczelnienia,
- w konsekwencji oszczędza się czas i ogranicza koszty.

Do montażu uszczelnień tłoczków, w zależności od tworzywa oferowane są różne narzędzia montażowe.

1. Uszczelnienia tłoczek z Elastomeru

1A. Podstawowym narzędziem pomocnym w zabudowie są szczypce montażowe. Za ich pomocą montaż uszczelnień, zarówno o mniejszych jak i większych średnicach przebiega szybko i pewnie.

W tym celu należy:

- Szczypce rozewrzeć i ująć uszczelnienie za pomocą bolców (zwrócić uwagę na kierunek zabudowy!).
- Zamknąć szczypce do oporu: uszczelnienie deformuje się i przybiera kształt nerki.
- Uszczelnienie wprowadzić do rowka służącego do zabudowy.
- Szczypce zwolnić i usunąć. Teraz uszczelnienie z reguły samodzielnie wskakuje w rowek. W razie potrzeby ułożyć je palcem.

1B. Przy montażu uszczelnień tłoczków sprawdzają się, także takie narzędzia jak popychacz, tulejka prowadząca i uchwyt

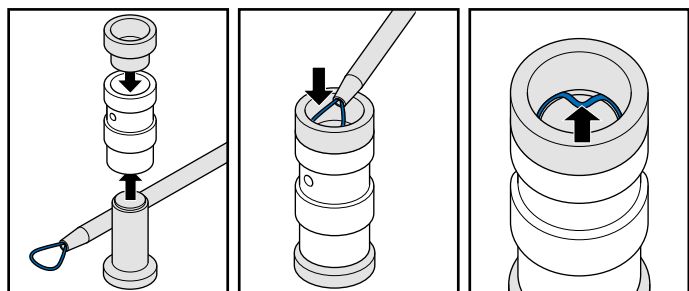

2. O-Ring-Montage | O-ring montaji | Montaż o-ringa |
Установка кольца круглого сечения

W tym celu:

- Zamocować cylinder w uchwycie
- Tuleję prowadzącą nasadzić na cylinder
- Wprowadzić uszczelnienie tłoczyśka
- Uszczelnienie wcisnąć za pomocą popychacza.

2. Uszczelnienia tłoczek z PTFE

Uszczelnienia tłoczek z PTFE składają się z reguły z dwóch komponentów: jednego pierścienia typu o-ring i jednego pierścienia ślizgowego. Oba te elementy można skutecznie zamontować w zaledwie trzech krokach. W tym celu dostępne są następujące narzędzia pomocnicze: popychacz, tuleja prowadząca, stożek kalibracyjny, chwytacz oraz uchwyt mocujący (tylko do montażu pierścieni typu o-ring).

Krok 1: Montaż pierścienia typu o-ring

- Zamocować cylinder w uchwycie.
- Zamocować tuleję prowadzącą na cylindrze.
- Ściśnięty o-ring i uchwycić za pomocą chwytacza
- Wprowadzić o-ring do rowka i zwolnić z chwytacza.
- Za pomocą chwytacza docisnąć wystające z rowka fragmenty o-ringa.

Krok 2: Montaż pierścienia ślizgowego

- Zamocować cylinder w uchwycie.
- Zamocować tuleję prowadzącą na cylindrze.
- Nałożyć pierścień ślizgowy na popychacz
- Równomiernie dociskając wprowadzić popychacz do tulei prowadzącej
- Wyciągnąć popychacz z tulei prowadzącej.
- Usunąć cylinder z uchwytu.

Krok 3: Kalibracja

- Stożek kalibracyjny przesunąć nad zamontowanym wstępnie pierścieniem ślizgowym.

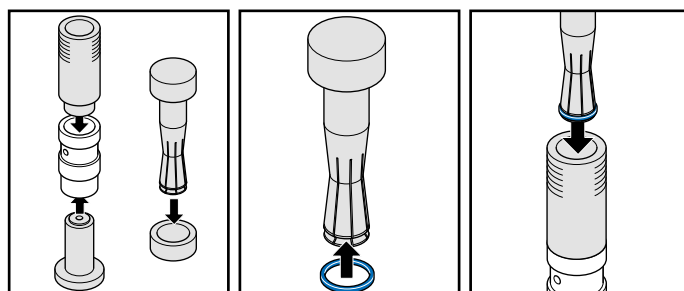

2. Gleitring-Montage | Kayar halka montaji | Montaż pierścienia ślizgowego |
Установка контактного уплотнительного кольца

RU ШТОКОВЫЕ УПЛОТНЕНИЯ

Какая польза от самого лучшего уплотнения, если оно неправильно установлено или повреждено при монтаже? Чтобы этого не случилось, «Фройденберг Силинг Технолоджис» предлагает Вам ассортимент монтажных инструментов. Безупречный монтаж в решающей степени влияет на эффективность и срок службы уплотнения и является, тем самым, существенным показателем качества. Монтажные инструменты «Фройденберг Силинг Технолоджис» позволяют Вам

- не допускать основных ошибок при монтаже,
- избегать при монтаже повреждения уплотняющей кромки,
- продлить срок службы уплотнения,
- сэкономить время и затраты.

Для монтажа штоковых уплотнений мы предлагаем различные инструменты, выбор которых зависит от материалов уплотнений.

1. Штоковые уплотнения из эластомеров

1А. Щипцы – универсальный монтажный инструмент. Они помогают быстро и надежно устанавливать уплотнения большого и малого диаметров в аксиально доступные канавки.

Для этого необходимо:

- Полностью раскрыть ручки щипцов и «пальцами» взяться за уплотнение (учитывайте направление монтажа!).
- До упора закрыть ручки щипцов. Уплотнение деформируется и приобретает почкообразную форму.
- Установить уплотнение в канавку.
- Ослабить ручки щипцов и вытащить их. Как правило, уплотнение само встает в канавку. При необходимости, поправить уплотнение пальцем.

1В. Не менее полезными инструментами при монтаже штоковых уплотнений являются толкатель, конусная втулка и контрупор.

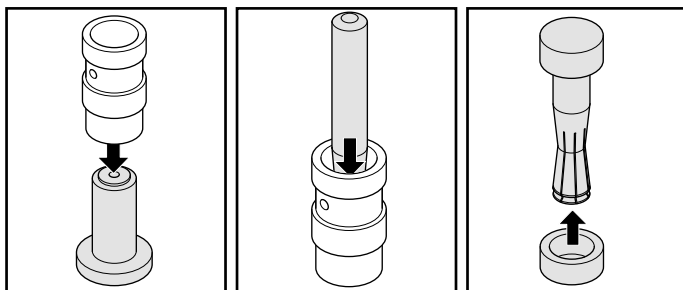

2. Kalibrieren | Kalibrasyon | kalibrowanie | Калибровка

При монтаже необходимо:

- Вставить контрупор в монтажное пространство
- Установить конус на монтажное пространство
- Вставить штоковое уплотнение
- Вдавить уплотнение толкателем

2. Штоковые уплотнения из ПТФЭ

Уплотнения из ПТФЭ, как правило, состоят из двух элементов: кольца круглого сечения и контактного уплотнительного кольца. Полный монтаж обоих элементов производится всего в три этапа. Для этого в качестве вспомогательных приспособлений используются адаптер расширения, конусная втулка, калибровочная втулка, контрупор и держатель (только для монтажа кольца круглого сечения).

Этап 1: монтаж кольца круглого сечения

- Зафиксировать цилиндр контрупором
- Установить конусную втулку
- Сжать кольцо круглого сечения и вставить его в держатель
- Вставить кольцо круглого сечения в канавку и вытолкнуть кольцо из держателя
- Вдавить держателем в канавку еще выступающую часть кольца круглого сечения.

Этап 2: монтаж контактного уплотнительного кольца

- Зафиксировать цилиндр контрупором
- Установить конусную втулку
- Снять конус с адаптера расширения и вложить контактное уплотнительное кольцо в паз адаптера расширения
- Вставить адаптер расширения в конусную втулку и равномерно протолкнуть через него адаптер расширения
- Вытащить адаптер расширения из конусной втулки.
- Снять цилиндр с контрупора.





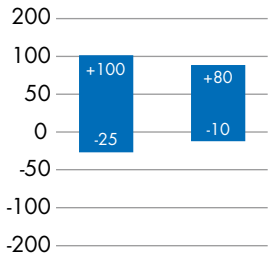
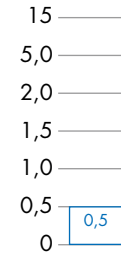







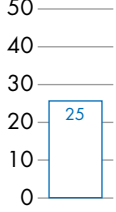
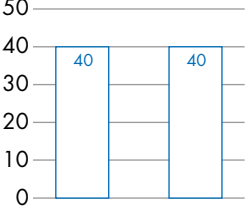
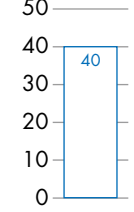
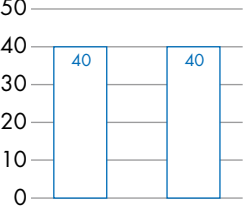
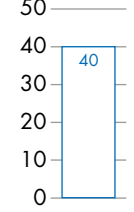
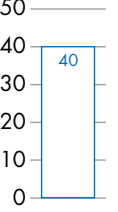

Этап 3: калибровка

- Смазанную смазкой калибровочную втулку протолкнуть через установленное контактное уплотнительное кольцо.

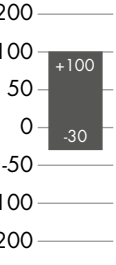
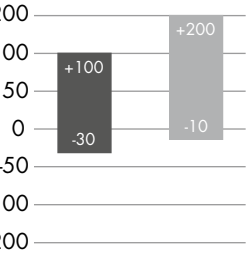
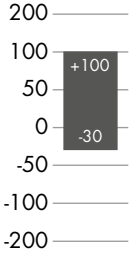
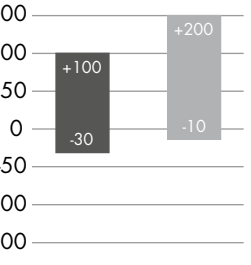
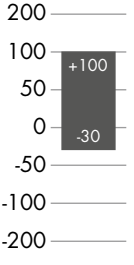
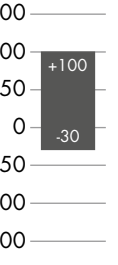
Type	NA 150	NA 250	NA 300	NA 400	TM 21		TMP 21	
Standard	ISO	ISO	ISO	ISO	ISO		ISO	
Shape								
Compound	NBR 80 NBR 878	NBR / POM 80 NBR 878 PO992020	Polyurethane 94 AU 925	NBR / POM 80 NBR 878 PO992020	Polyurethane 95 AU V142	Polyurethane 93 AU V167	Polyurethane 93 AU V167	Polyurethane 93 AU V168
								
								
								
Applications								

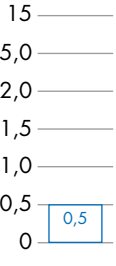
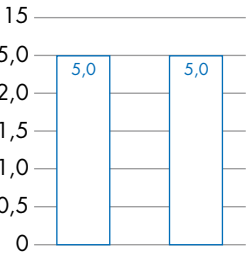
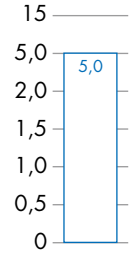
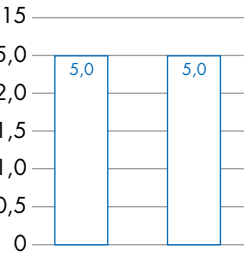
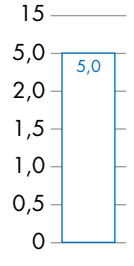
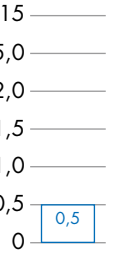
Bitte beachten Sie unsere allgemeinen Konstruktionshinweise in → Technisches Handbuch
 Daha detaylı montaj bilgisi için → Bkz. Technical Manual
 W celu zaznajomienia się z ogólnymi uwagami proszę skorzystać z Instrukcji
 Общие технические рекомендации см. → Техническое руководство

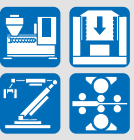
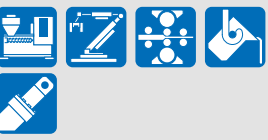
N 1 / AUN 1		N 100 / AUN 100		T 18	T 42	T 44	0215	0217
ISO		ISO		ISO	ISO	ISO	ISO	ISO
NBR 90 NBR 109	Polyurethane 94 AU 925	NBR 90 NBR 109	Polyurethane 94 AU 925	Polyurethane/POM 95 AU V142 PO202	Polyurethane/ NBR/POM 93 AU V167 NBR/PO202	Polyurethane/ NBR/POM 93 AU V167 NBR/PO202	NBR/POM/PA 80 NBR B246 PO202 PA 6.G200	NBR/POM/PA 80 NBR B246 PO202 PA 6.G200

Type	OMK-PU	OMK-E		OMK-ES	OMK-MR		OMK-S	Simko 300
Standard	ISO	ISO		ISO	ISO		ISO	ISO
Shape								
Compound	Polyurethane/NBR 95 AU V142 B276	PTFE/NBR GM201/B275 B602/B276	PTFE/FKM B602/K566	PTFE/NBR B602/B246 GM201/B246	PTFE/NBR B602/B276 GM201/B276	PTFE/FKM B602/K655	PTFE/NBR B602/B246 GM201/B246	Polyurethan/NBR 98 AU 928/B72 98 AU 928/709
								
								
								
Applications								

Bitte beachten Sie unsere allgemeinen Konstruktionshinweise in → Technisches Handbuch
 Daha detaylı montaj bilgisi için → Bkz. Technical Manual
 W celu zaznajomienia się z ogólnymi uwagami proszę skorzystać z Instrukcji
 Общие технические рекомендации см. → Техническое руководство

HDP 330	Simko 320 X2	Simko 520	L 27	L 43	T 19	TFMA	TDUOH	T MF
ISO	ISO	ISO	ISO	ISO	ISO	ISO	ISO	ISO
Polyamide / NBR PA 4112 / 177605	NBR / PA 80 NBR 878 / PA	NBR / POM 80 NBR PO992020	PTFE / NBR / POM B602 / B247 / PO202 B602 / B203 / PO202	NBR / TPE / PA 70 NBR B281 TP1 13 PA6501	Polyurethan / POM 95 AU V142 PO202	PTFE / NBR 177023 / NBR	NBR 90 NBR 109	NBR 88 NBR 101

Type	T OF	EK / EKV		FOA	CPH	CPI	ODI	OSI
Standard	ISO	ISO		ISO	JIS	JIS	JIS	JIS
Shape								
Compound	NBR 88 NBR 101	NBR BHNBR	FKM BHFKM	PTFE 10/F56110	NBR 70 A 102/70 A 103 70 A 104/70 A 505	Polyurethan 94 U801	Polyurethan 94 U801	Polyurethan 94 U801
Applications								

Bitte beachten Sie unsere allgemeinen Konstruktionshinweise in → Technisches Handbuch
 Daha detaylı montaj bilgisi için → Bkz. Technical Manual
 W celu zaznajomienia się z ogólnymi uwagami proszę skorzystać z Instrukcji
 Общие технические рекомендации см. → Техническое руководство

OUHR		OUIS		SPG		SPGC	
JIS		JIS		JIS		JIS	
NBR 90 A505	NBR 82 A567	Polyurethan 94 U801	Polyurethan 94 U641	PTFE/NBR 19YF/80 A980	PTFE/FKM 19YF/70 F201	PTFE/NBR 31BF/70 A305	PTFE/FKM 31BF/70 F201

Type	SPGO		SPGW		
Standard	JIS		JIS		
Shape					
Compound	PTFE / NBR 19YF / 70 A305	PTFE / FKM 19YF / 70 F201	PTFE / NBR 19YF / 80 A980	PTFE / FKM 19YF / 70 F201	PTFE / HNBR 19YF / 85 G928
 MPa					
 Celsius					
 m/s					
Applications					

Bitte beachten Sie unsere allgemeinen Konstruktionshinweise in → Technisches Handbuch

Daha detaylı montaj bilgisi için → Bkz. Technical Manual

W celu zaznajomienia się z ogólnymi uwagami proszę skorzystać z Instrukcji

Общие технические рекомендации см. → Техническое руководство

KOLBEN- UND SYMMETRISCHE DICHTUNGEN | PISTON VE SIMETRIK SIZDIRMAZLIK ELEMANLARI USZCZELNIENIA TŁOKA ORAZ SYMETRYCZNE | ПОРШНЕВЫЕ И СИММЕТРИЧНЫЕ УПЛОТНЕНИЯ

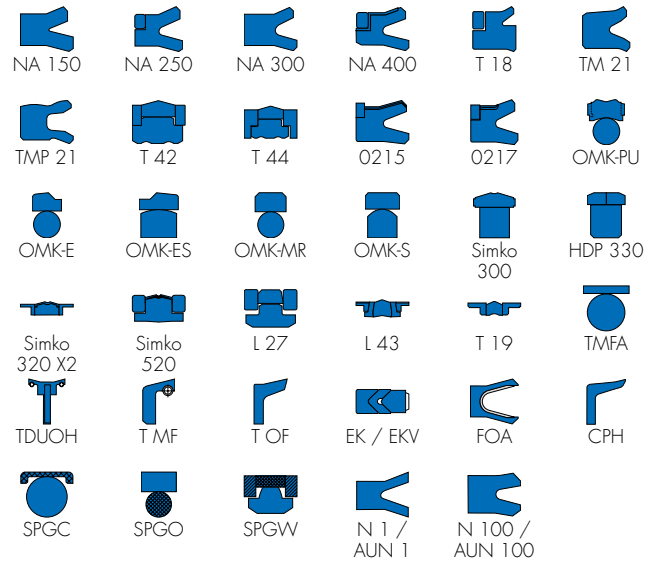
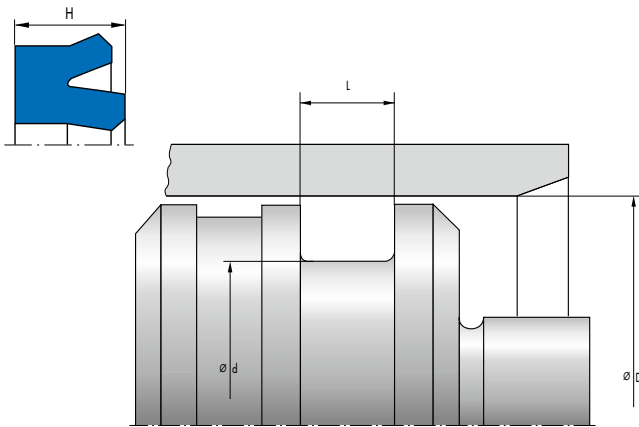

Wenn Sie Ihre Dichtung nicht finden können – Ihre Lösung auf Seite 12
Aradığınız ürünü bulamadığınız takdirde – çözümünüz sayfa 12
Jeżeli nie możecie Państwo znaleźć uszczelki – rozwiązanie znajduje się na stronie 12
Вы не можете подобрать необходимое уплотнение? – Решение на странице 12

1) IP = Industriepackung | Endüstriyel ambalaj | Opakowania przemysłowe | Производственная тара
SP = Einzelpackung | Tek bir Paketi | Pojedyncze opakowanie | Single Pack

● Auf Lager | Stoklarda mevcuttur | Dostępne w magazynie | Имеется в наличии на складе
○ Auf Anfrage | Talep üzerine | Na zapytanie | По запросу

D [mm]	d [mm]	H [mm]	L [mm]	Material	Design	Part No.	PU ¹⁾	US	EU
6	3	2,3	2,5	31BF / 70 A305	SPGC	GS1000-F0	–	○	
7	3	5	6	90 NBR 109	N 1	15949 40421339	IP SP		● ●
	4	2,3	2,5	31BF / 70 A305	SPGC	GS1001-F0	–	○	
	3,1	2	2,2	PTFE B602 / FKM	OMK-E	24262428	–		○
8	3,1	2	2,2	PTFE B602 / NBR	OMK-E	24275916	–		○
	3,1	2	2,2	PTFE GM201 / NBR	OMK-E	24276238	–		○
	3,1	2	2,2	PTFE GM201 / NBR	OMK-MR	24213518	–		○
	3,1	2	2,2	PTFE B602 / NBR	OMK-MR	24213753	–		○
	3,1	2	2,2	PTFE B602 / FKM	OMK-MR	24348353	–		○
8,5	5	2,3	2,5	31BF / 70 A305	SPGC	GS1002-F0	–	○	
	3	4	4,7	90 NBR 109	N 1	15948 40421338	IP SP		● ●
	4,1	2	2,2	PTFE GM201 / NBR	OMK-MR	24232096	–		○
9	4,1	2	2,2	PTFE GM201 / FKM	OMK-MR	24268208	–		○
	6	2,3	2,5	31BF / 70 A305	SPGC	GS1003-F0	–	○	
10	2	3,8	4,5	90 NBR 109	N 1	15946 40421337	IP SP	○	● ● ●
	3,9	3	3,2	PTFE 177023	TFMA	96028	–		○
	4	3	1	88 NBR 101	T OF	14689	–		○
	4	4	4,7	94 AU 925	AUN 1	13916 40421155	IP SP		● ● ●
	4	4	4,7	90 NBR 109	N 1	15956 40421340	IP SP		● ● ●
	5,1	2	2,2	PTFE B602 / NBR	OMK-E	24275925	IP		●
	5,1	2	2,2	PTFE GM201 / NBR	OMK-E	24276247	–		○
	5,1	2	2,2	PTFE B602 / FKM	OMK-E	24345101	–		○

D [mm]	d [mm]	H [mm]	L [mm]	Material	Design	Part No.	PU ¹⁾	US	EU
10	5,1	2	2,2	PTFE GM201 / NBR	OMK-MR	24213519	-		○
	5,1	2	2,2	PTFE B602 / NBR	OMK-MR	24213755	IP		●
	5,1	2	2,2	PTFE GM201 / FKM	OMK-MR	24241133	-		○
	5,1	2	2,2	PTFE B602 / FKM	OMK-MR	24330049	-		○
	7	2,3	2,5	31BF / 70 A305	SPGC	GS1004-F0	-	○	
	7,1	2,1	2,4	PTFE F56110	FOA	422091	IP		●
11	4	8	1,5	88 NBR 101	T OF	14701	-		○
	5	5	6	90 NBR 109	N 1	15980 40421344	IP SP		● ●
	8	2,3	2,5	31BF / 70 A305	SPGC	GS1005-F0	-	○	
12	0	8	4	88 NBR 101	T OF	14715	IP		●
	3	6	1,5	88 NBR 101	T OF	14712	-		○
	4	4	4,7	90 NBR 109	N 1	15957 40421341	IP SP		● ●
	4	6	2	88 NBR 101	T OF	14708	-		○
	5	5	6	94 AU 925	AUN 1	14307 40421193	IP SP		● ●
	5	5	6	90 NBR 109	N 1	15974 40421342	IP SP		● ●
	5,9	3	3,2	PTFE 177023	TFMA	98533	-		○
	6	4	4,5	80 NBR 878	NA 150	84515 40421754	IP SP		● ●
	6	4	4,7	90 NBR 109	N 1	15999 40421347	IP SP		● ●
	6	6	7	94 AU 925	AUN 1	14401 40421239	IP SP		● ●
	6	6	7	90 NBR 109	N 1	16007 40421349	IP SP		● ●
	7,1	2	2,2	PTFE B602 / NBR	OMK-E	24275944	IP		●
	7,1	2	2,2	PTFE GM201 / NBR	OMK-E	24276265	-		○
	7,1	2	2,2	PTFE B602 / FKM	OMK-E	24345102	-		○
7,1	2	2,2	PTFE GM201 / NBR	OMK-MR	24213520	-		○	
7,1	2	2,2	PTFE B602 / NBR	OMK-MR	24213757	IP		●	
7,1	2	2,2	PTFE B602 / FKM	OMK-MR	24237996	-		○	
9	2,3	2,5	31BF / 70 A305	SPGC	GS1006-F0	-	○		
9,1	2,1	2,4	PTFE F56110	FOA	435978	IP		●	
13	0	6	2	88 NBR 101	T OF	14721	-		○
	10	2,3	2,5	31BF / 70 A305	SPGC	GS1007-F0	-	○	
14	0	8	4	88 NBR 101	T OF	14727	-		○
	5	4,5	5,2	90 NBR 109	N 1	11657 40421078	IP SP		● ●
	5	8	2	88 NBR 101	T OF	13336	-		○
	6	5	1,5	88 NBR 101	T OF	14728 40421253	IP SP		● ●
	7	3,5	4	90 NBR 109	N 1	16020 40421351	IP SP		● ●
	8	4	4,7	90 NBR 109	N 1	16039 40421355	IP SP		● ●
	8	6	7	94 AU 925	AUN 1	11768 40421085	IP SP	○	● ●
	8	6	7	90 NBR 109	N 1	16033 40421354	IP SP		● ●
	9,1	2	2,2	PTFE B602 / NBR	OMK-E	24256812	IP		●
	9,1	2	2,2	PTFE GM201 / NBR	OMK-E	24276368	-		○
	9,1	2	2,2	PTFE B602 / FKM	OMK-E	24345103	-		○
	9,5	2,1	3,6	PTFE F56110	FOA	417777	-		○
	10	3	3,2	31BF / 70 A305	SPGC	GS1008-F0	-	○	
	14,3	9,4	2	2,2	PTFE B602 / NBR	OMK-MR	24289786	-	
14,5	9,6	2	2,2	PTFE B602 / NBR	OMK-MR	24288827	-		○

D [mm]	d [mm]	H [mm]	L [mm]	Material	Design	Part No.	PU ¹⁾	US	EU
15	5	5	6	90 NBR 109	N 1	15977 40421343	IP SP		● ●
	6	5	1,5	88 NBR 101	T OF	14732 40421254	IP SP		● ●
	6	5	6	90 NBR 109	N 1	16001 40421348	IP SP		● ●
	6	7	3	88 NBR 101	T OF	14730	-		○
	6	8	9	94 AU 925	AUN 1	11760 40421083	IP SP		● ●
	7	5	6	90 NBR 109	N 1	16019 40421350	IP SP		● ●
	7	7	8	94 AU 925	AUN 1	13626 40421141	IP SP		● ●
	7,5	3	3,2	PTFE GM201 / NBR	OMK-MR	24213521	-		○
	7,5	3	3,2	PTFE B602 / NBR	OMK-MR	24213759	IP		●
	7,5	3	3,2	PTFE B602 / FKM	OMK-MR	24348843	-		○
	8	6	7	90 NBR 109	N 1	16030 40421353	IP SP		● ●
	8,9	3	3,2	PTFE 177023	TFMA	97882	-		○
	10	5	6	90 NBR 109	N 1	16062 40421360	IP SP		● ●
	10	5	6	90 NBR 109	N 1	16075 40421365	IP SP		● ●
	10,1	2	2,2	PTFE B602 / NBR	OMK-E	24276002	-		○
	10,1	2	2,2	PTFE GM201 / NBR	OMK-E	24276346	-		○
	10,1	2	2,2	PTFE B602 / FKM	OMK-E	24345104	-		○
	11	3	3,2	31BF / 70 A305	SPGC	GS1009F0	-	○	
	15,2	11,2	3	3,2	31BF / 70 A305	SPGC	GS1010F0	-	○
16	0	6	2	88 NBR 101	T OF	14748	-		○
	6	5	6	90 NBR 109	N 1	15996 40421346	IP SP		● ●
	6	8	9	94 AU 925	NA 300	21658 40421660	IP SP		● ●
	7	6,5	2	88 NBR 101	T OF	14746 40421255	IP SP		● ●
	8	4	4,7	90 NBR 109	N 1	16040 40421356	IP SP		● ●
	8	6	7	94 AU 925	AUN 1	11766 40421084	IP SP		● ●
	8	6	7	90 NBR 109	N 1	16029 40421352	IP SP		● ●
	8	8	9	90 NBR 109	N 100	18047 40421574	IP SP		● ●
	8,5	3	3,2	PTFE GM201 / NBR	OMK-MR	24208135	-		○
	8,5	3	3,2	PTFE B602 / NBR	OMK-MR	24213761	IP		●
	8,5	3	3,2	PTFE B602 / FKM	OMK-MR	24260916	-		○
	9,9	3	3,2	PTFE 177023	TFMA	98699	IP		●
	10	4	4,5	80 NBR 878	NA 150	84516 40421755	IP SP		● ●
	10	4	4,7	90 NBR 109	N 1	16070 40421363	IP SP		● ●
	10	5	6	90 NBR 109	N 1	16078 40421366	IP SP		● ●
	10	6	7	94 AU 925	AUN 1	13641 40421144	IP SP		● ●
	11	2	2,2	PTFE B602 / NBR	OMK-E	49062023	-		○
	11	2	2,2	PTFE GM201 / NBR	OMK-E	49062024	-		○
	11	2	2,2	PTFE B602 / FKM	OMK-E	49062478	-		○
11,1	2	2,2	PTFE B602 / NBR	OMK-E	24275929	-		○	

D [mm]	d [mm]	H [mm]	L [mm]	Material	Design	Part No.	PU ¹⁾	US	EU
16	11,1	2	2,2	PTFE GM201 / NBR	OMK-E	24276250	-		○
	11,1	2	2,2	PTFE B602 / NBR	OMK-E	49008573	-		○
	11,5	3,2	3,6	PTFE F56110	FOA	372523	IP		●
	12	3	3,2	31BF / 70 A305	SPGC	GS1011-F0	-	○	
16,5	12,5	3	31BF / 70 A305	SPGC	GS1012-F0	-	○		
17	6,5	5,5	1,5	88 NBR 101	T OF	14753	-		○
	8	6	7	90 NBR 109	N 1	16044 40421358	IP SP		● ●
	8	7	1,5	88 NBR 101	T OF	14759 40421256	IP SP		● ●
	9	6	7	90 NBR 109	N 1	16049 40421359	IP SP		● ●
	9,5	3	3,2	PTFE B602 / NBR	OMK-MR	24328303	-		○
	18	5	5	2	88 NBR 101	T OF	14762 40421258	IP SP	
5		7	3	88 NBR 101	T OF	14761 40421257	IP SP		● ●
6		8	9	90 NBR 109	N 1	15992 40421345	IP SP		● ●
8		7,5	8,5	94 U801	ODI	FU2150-H0	-	○	
8		8	9	90 NBR 109	N 1	16042 40421357	IP SP		● ●
10		5	6	90 NBR 109	N 1	16068 40421362	IP SP	○	● ●
10		8	9	94 AU 925	AUN 1	13640 40421143	IP SP		● ●
10,5		3	3,2	PTFE GM201 / NBR	OMK-MR	24213522	IP		●
10,5		3	3,2	PTFE B602 / NBR	OMK-MR	24213763	IP		●
10,5		3	3,2	PTFE B602 / FKM	OMK-MR	24348354	-		○
10,7		3	3,2	PTFE B602 / NBR	OMK-E	24275921	-		○
10,7		3	3,2	PTFE GM201 / NBR	OMK-E	24276243	-		○
10,7		3	3,2	PTFE B602 / FKM	OMK-E	24345106	-		○
11,9		3	3,2	PTFE 177023	TFMA	97889	IP		●
12		4	4,7	90 NBR 109	N 1	16104 40421369	IP SP		● ●
12		5	6	90 NBR 109	N 1	16109 40421370	IP SP		● ●
12		6	7	94 AU 925	AUN 1	13658 40421147	IP SP	○	● ●
14		3	3,2	31BF / 70 A305	SPGC	GS1013-F0	-	○	
19	0	6	2	88 NBR 101	T OF	14773	-		○
	15	3	3,2	31BF / 70 A305	SPGC	GS1014-F0	-	○	
19,1	11,6	3	3,2	PTFE B602 / FKM	OMK-MR	24274993	-		○
19,2	11,2	5	5,7	94 U801	ODI	FU0202-H0	-	○	
20	6	8	9	90 NBR 109	N 1	15991	-		○
	8	5	1,5	88 NBR 101	T OF	14780	-		○
	8	6,5	3	88 NBR 101	T OF	14779 40421260	IP SP		● ●
	10	5	2	88 NBR 101	T OF	14778 40421259	IP SP		● ●
	10	6	7	94 U801	ODI	FU0205-H0	-	○	
	10	7,5	8,5	94 U801	ODI	FU0206-H0	-	○	
	10	8	2,5	88 NBR 101	T OF	14781 40421261	IP SP		● ●
	10	8	9	94 AU 925	AUN 1	13642 40421145	IP SP		● ●

D [mm]	d [mm]	H [mm]	L [mm]	Material	Design	Part No.	PU ¹⁾	US	EU
20	10	8	9	94 AU 925	AUN 100	14343 40421202	IP SP		● ●
	10	8	9	90 NBR 109	N 100	17744 40421540	IP SP		● ●
	10	8	9	94 AU 925	NA 300	21663 40421661	IP SP		● ●
	10	8	9	94 U801	ODI	FU0207-H0	-	○	
	12	5	5,7	94 U801	ODI	FU0208-H0	-	○	
	12	5,5	6	80 NBR 878	NA 150	84517 40421756	IP SP	○	● ●
	12	8	9	94 AU 925	AUN 1	14273 40421188	IP SP		● ●
	12	8	9	90 NBR 109	N 1	18035 40421573	IP SP		● ●
	12,5	3	3,2	PTFE B602 / FKM	OMK-E	49062025	-		○
	12,5	3	3,2	PTFE B602 / NBR	OMK-E	49062026	-		○
	12,5	3	3,2	PTFE GM201 / NBR	OMK-E	49062027	-		○
	12,5	3	3,2	PTFE GM201 / NBR	OMK-MR	24131850	IP		●
	12,5	3	3,2	PTFE B602 / NBR	OMK-MR	24178456	IP		●
	12,5	3	3,2	PTFE GM201 / FKM	OMK-MR	24306618	-		○
	12,5	3	3,2	PTFE B602 / FKM	OMK-MR	24348355	-		○
	12,5	3	3,2	95 AU V142	OMK-PU	24341354	-		○
	12,5	3	3,2	98 AU 928	SK 300	417924	IP		●
	12,7	3	3,2	PTFE GM201 / NBR	OMK-E	24231905	-		○
	12,7	3	3,2	PTFE B602 / NBR	OMK-E	24248890	IP		●
	12,7	3	3,2	PTFE B602 / FKM	OMK-E	24339788	-		○
13	3	3,6	90 NBR 109	N 1	16143 40421375	IP SP		● ●	
13,9	3	3,2	PTFE 177023	TFMA	98990	IP		●	
14	3	3,2	19YF / 70 A305	SPGO	GS1800-V0	-	○		
14	4	4,7	90 NBR 109	N 1	16152 40421377	IP SP	○	● ●	
15	3	3,6	90 NBR 109	N 1	16179 40421384	IP SP		● ●	
15,5	3,2	3,6	PTFE F56110	FOA	366331	IP		●	
16	3	3,2	31BF / 70 A305	SPGC	GS1015-F0	-	○		
20,4	10	8	2,5	88 NBR 101	T MF	14787 40421262	IP SP		● ●
20,6	13,1	3	3,2	PTFE B602 / FKM	OMK-MR	24274991	-		○
22	6	7	2	88 NBR 101	T OF	14794 40421263	IP SP		● ●
	6	8	9	90 NBR 109	N 1	16000	-		○
	8	8	9	94 AU 925	AUN 1	14041	-		○
	8	8	9	90 NBR 109	N 1	16037	-		○
	9	7,5	2,5	88 NBR 101	T OF	14795 40421264	IP SP	○	● ●
	10	6	7	94 AU 925	AUN 1	13639 40421142	IP SP		● ●
	10	6	7	90 NBR 109	N 1	16064 40421361	IP SP		● ●
	10	8	9	94 AU 925	AUN 100	14344 40421203	IP SP		● ●
	10	8	9	90 NBR 109	N 100	17982 40421569	IP SP		● ●
	12	5	6	94 AU 925	AUN 1	13660	-		○
12	5	6	90 NBR 109	N 1	16117 40421372	IP SP		● ●	

D [mm]	d [mm]	H [mm]	L [mm]	Material	Design	Part No.	PU ¹⁾	US	EU
22	12	7	8	90 NBR 109	N 1	16120 40421373	IP SP		● ●
	12	8	9	94 AU 925	AUN 1	13655 40421146	IP SP		● ●
	12	8	9	94 AU 925	AUN 100	14345 40421204	IP SP		● ●
	12	8	9	94 AU 925	NA 300	21668 40421662	– SP	○	● ●
	14	4	4,7	90 NBR 109	N 1	16151 40421376	IP SP		● ●
	14	5	5,7	94 U801	ODI	FU0242-H0	–	○	
	14	6	7	94 AU 925	AUN 1	14059 40421157	IP SP		● ●
	14	6	7	90 NBR 109	N 1	16156 40421380	IP SP		● ●
	14	8	9	94 AU 925	AUN 1	13667 40421148	IP SP		● ●
	14	8	9	90 NBR 109	N 1	16155 40421379	IP SP	○	● ●
	14,5	3	3,2	PTFE GM201 / NBR	OMK-MR	24131851	IP		●
	14,5	3	3,2	PTFE B602 / NBR	OMK-MR	24178457	IP		●
	14,5	3	3,2	PTFE B602 / FKM	OMK-MR	24257623	–		○
	14,7	3	3,2	PTFE B602 / NBR	OMK-E	24275923	–		○
	14,7	3	3,2	PTFE GM201 / NBR	OMK-E	24276245	–		○
14,7	3	3,2	PTFE B602 / FKM	OMK-E	24345107	–		○	
23	15	4	4,7	90 NBR 109	N 1	16180 40421385	IP SP		● ●
	15,9	3	3,2	PTFE 177023	TFMA	98386	IP		●
	16	4	4,7	94 AU 925	AUN 1	11803 40421088	IP SP	○	● ●
	16	4	4,7	90 NBR 109	N 1	16201 40421390	IP SP		● ●
	16	6	7	90 NBR 109	N 1	16194 40421387	IP SP		● ●
	18	3	3,2	31BF / 70 A305	SPGC	GS1016-F0	–	○	
	23,5	15,5	3	3,2	PTFE B602 / NBR	OMK-MR	24345587	–	
24	12	6	7	90 NBR 109	N 1	16102 40421368	IP SP		● ●
	12	9	10	94 AU 925	AUN 1	14256 40421185	IP SP		● ●
	12	10	11	90 NBR 109	N 100	17978 40421568	IP SP		● ●
	12,8	7	2	88 NBR 101	T OF	14811	–		○
	13	6	7	90 NBR 109	N 1	16139 40421374	IP SP		● ●
	14	7,5	8,5	94 U801	ODI	FU2151-H0	–	○	
	14	8	9	94 AU 925	AUN 100	14347 40421206	IP SP		● ●
	15	7	8	90 NBR 109	N 1	16177 40421383	IP SP		● ●
	16,5	3	3,2	PTFE GM201 / NBR	OMK-MR	24191844	–		○
	16,5	3	3,2	PTFE B602 / NBR	OMK-MR	24213766	–		○
	16,5	3	3,2	PTFE B602 / FKM	OMK-MR	24348356	–		○
	18	4	4,7	90 NBR 109	N 1	16233 40421396	IP SP		● ●
	18	5	6	90 NBR 109	N 1	16230 40421394	IP SP		● ●
	19,5	3,2	3,6	PTFE F56110	FOA	525886	–		○
	20	3	3,2	31BF / 70 A305	SPGC	GS1017-F0	–	○	

D [mm]	d [mm]	H [mm]	L [mm]	Material	Design	Part No.	PU ¹⁾	US	EU
25	0	7	3	88 NBR 101	T OF	14821 40421267	IP SP		● ●
	8	6	1,5	88 NBR 101	T OF	14822 40421268	IP SP		● ●
	8	6	7	94 AU 925	AUN 1	13630	–		○
	8	22		90 NBR 109	TDUOH	9620	IP		●
	9	8	2,5	88 NBR 101	T OF	14819 40421266	IP SP		● ●
	10	6	7	90 NBR 109	N 1	16072 40421364	IP SP		● ●
	10	8	9	90 NBR 109	N 1	16069	–		○
	10	10	2,4	94 U801	CPI	FC0013-C0	–	○	
	10	10	11	90 NBR 109	N 100	17912 40421559	IP SP		● ●
	12	7	2,5	88 NBR 101	T OF	14823 40421269	IP SP		● ●
	12	8	9	94 AU 925	AUN 1	14053 40421156	IP SP		● ●
	12	8	9	90 NBR 109	N 1	16110 40421371	IP SP		● ●
	12	10	11	94 AU 925	AUN 100	14346 40421205	IP SP		● ●
	15	5	1,5	88 NBR 101	T OF	14817 40421265	IP SP		● ●
	15	5	6	90 NBR 109	N 1	16174 40421381	IP SP		● ●
	15	6	7	94 U801	ODI	FU0273-H0	–	○	
	15	8	9	94 AU 925	AUN 1	11797 40421086	IP SP		● ●
	15	8	9	94 AU 925	AUN 100	11799 40421087	IP SP		● ●
	15	8	9	94 AU 925	NA 300	21675 40421663	– SP	○	● ●
	15	8	9	80 NBR 878	NA 400	25279	–		○
	15	8	9	94 U801	ODI	FU0274-H0	–	○	
	16	5	6	90 NBR 109	N 1	16216 40421392	IP SP		● ●
	16,2	6	2	88 NBR 101	T OF	14818	–		○
	17	5	5,7	94 U801	ODI	FU0275-H0	–	○	
	17	5,5	6	80 NBR 878	NA 150	84518 40421757	IP SP		● ●
	17	9,3	10	95 AU V142	T 19	24314979	–		○
	17	19,9	19,9	80 NBR 878	SK 320	10600	IP		●
	17,5	3	3,2	PTFE GM201 / NBR	OMK-E	24218024	–		○
	17,5	3	3,2	PTFE B602 / FKM	OMK-E	49062028	–		○
	17,5	3	3,2	PTFE B602 / NBR	OMK-E	49062029	–		○
	17,5	3	3,2	PTFE GM201 / NBR	OMK-MR	24131852	IP		●
	17,5	3	3,2	PTFE B602 / NBR	OMK-MR	24178458	IP		●
17,5	3	3,2	PTFE B602 / FKM	OMK-MR	24258030	–		○	
17,5	3	3,2	PTFE C104 / NBR	OMK-MR	49036116	–		○	
17,5	3	3,2	98 AU 928	SK 300	416478	IP	○	●	
17,7	3	3,2	PTFE B602 / NBR	OMK-E	24260930	IP		●	
17,7	3	3,2	PTFE B602 / FKM	OMK-E	24260932	–		○	
17,7	3	3,2	PTFE GM201 / NBR	OMK-E	24275717	–		○	
17,8	3,8	4	PTFE 177023	TFMA	95440	IP		●	
18	4	4,7	90 NBR 109	N 1	16232 40421395	IP SP		● ●	

D [mm]	d [mm]	H [mm]	L [mm]	Material	Design	Part No.	PU ¹⁾	US	EU
25	19	3	3,2	19YF / 70 A305	SPGO	GS1801-V0	-	○	
	20,5	3,2	3,6	PTFE F56110	FOA	366333	IP		●
	21	3	3,2	31BF / 70 A305	SPGC	GS1018-F0	-	○	
25,4	0	5	1,5	88 NBR 101	T OF	14843 40421270	IP SP		● ●
	0	7	2,5	88 NBR 101	T OF	14848 40421272	IP SP	○	● ●
26	8	22		90 NBR 109	TDUOH	9622	-		○
	8,2	8	2,2	88 NBR 101	T OF	14847 40421271	IP SP		● ●
	10	8	9	90 NBR 109	N 1	16067	-		○
	12	8	9	90 NBR 109	N 1	16098	-		○
	12	10	11	90 NBR 109	N 100	18056 40421575	IP SP		● ●
	16	5	6	94 AU 925	AUN 1	14078 40421158	IP SP		● ●
	16	5	6	90 NBR 109	N 1	16192 40421386	IP SP		● ●
	16	7,5	8,5	94 U801	ODI	FU2152-H0	-	○	
	16	8	9	94 AU 925	AUN 100	14420 40421243	IP SP		● ●
	18	4	4,7	90 NBR 109	N 1	16235 40421397	IP SP		● ●
	18	5	5,7	94 U801	ODI	FU0310-H0	-	○	
	18,5	3	3,2	PTFE GM201 / NBR	OMK-MR	24231122	-		○
	18,5	3	3,2	PTFE B602 / NBR	OMK-MR	24257967	-		○
	19	5	6	90 NBR 109	N 1	16273 40421400	IP SP		● ●
	22	3	3,2	31BF / 70 A305	SPGC	GS1020-F0	-	○	
27	11	8	3	88 NBR 101	T OF	14860	-		○
	19,5	2,95	3,2	PA 4112	HDP 330	49055230	-		○
28	10	8	9	90 NBR 109	N 1	16059	-		○
	10	9	10	94 AU 925	AUN 1	11780	-		○
	10	10	2	88 NBR 101	T MF	14866	-		○
	10	10	2,4	94 U802	CPI	FC0015-C0	-	○	
	12	10	11	90 NBR 109	N 1	16100 40421367	IP SP		● ●
	14	10	11	90 NBR 109	N 100	17805 40421549	IP SP		● ●
	15	10	11	94 AU 925	AUN 100	11800	-		○
	15	10	11	90 NBR 109	N 1	16172	-		○
	15	10	11	90 NBR 109	N 100	17783 40421546	IP SP		● ●
	15	10	11	94 U801	ODI	FU2153-H0	-	○	
	16	6	1,5	88 NBR 101	T OF	14865 40421273	IP SP		● ●
	16	6	7	94 AU 925	AUN 1	13679 40421149	IP SP		● ●
	16	8	2,5	88 NBR 101	T OF	14868	-		○
	17,3	4	4,2	PTFE B602 / NBR	OMK-E	24275935	-		○
	17,3	4	4,2	PTFE GM201 / NBR	OMK-E	24276256	-		○
17,3	4	4,2	PTFE B602 / FKM	OMK-E	24345108	-		○	
18	8	9	94 AU 925	AUN 1	13689 40421151	IP SP		● ●	
18	8	9	94 AU 925	AUN 100	11812 40421089	IP SP		● ●	
18	8	9	90 NBR 109	N 1	17422 40421523	IP SP		● ●	

D [mm]	d [mm]	H [mm]	L [mm]	Material	Design	Part No.	PU ¹⁾	US	EU
28	20	4	4,7	90 NBR 109	N 1	16294 40421405	IP SP	○	● ●
	20	5	5,7	94 U801	ODI	FU2138-H0	-	○	
	20	8	9	94 AU 925	AUN 1	11818 40421092	IP SP		● ●
	20,5	3	3,2	PTFE GM201 / NBR	OMK-MR	24131853	IP		●
	20,5	3	3,2	PTFE B602 / NBR	OMK-MR	24178459	IP		●
	20,5	3	3,2	PTFE B602 / FKM	OMK-MR	24348377	-		○
	20,8	3,8	4	PTFE 177023	TFMA	98534	IP		●
	22	4,4	4,7	31BF / 70 A305	SPGC	GS1019-F0	-	○	
	22	5	6	90 NBR 109	N 1	16339 40421412	IP SP		● ●
	22	8	9	94 AU 925	AUN 1	11834	-		○
28,4	22,4	4,4	4,7	31BF / 70 A305	SPGC	GS1021-F0	-	○	
28,6	21,1	3	3,2	PTFE B602 / NBR	OMK-MR	24269612	-		○
29	16	6	7	90 NBR 109	N 1	16200 40421389	IP SP		● ●
30	8	8	2,5	88 NBR 101	T OF	14885	-		○
	8	17	3	88 NBR 101	T OF	14883	-		○
	10	6	2	88 NBR 101	T OF	14884	-		○
	10	10	2,5	88 NBR 101	T OF	14890 40421275	IP SP		● ●
	10	10	3	88 NBR 101	T MF	14888	-		○
	10	10	11	90 NBR 109	N 1	16060	-		○
	12	9	10	94 AU 925	AUN 1	14052	-		○
	12	9	10	90 NBR 109	N 1	16105	-		○
	12	10	2,4	94 U803	CPI	FC0020-C0	-	○	
	12	10	2,5	70 NBR A103	CPH	CC0020-C0	-	○	
	13	8	2,5	80 NBR 104	CPH	CC0019-C3	-	○	
	13	10	11	90 NBR 109	N 1	16135	-		○
	14	6	2	88 NBR 101	T OF	14887 40421274	IP SP		● ●
	14	8	9	94 AU 925	AUN 1	13664	-		○
	14	8	9	90 NBR 109	N 1	16154 40421378	IP SP		● ●
	15	8	9	94 AU 925	AUN 1	13675	-		○
	15	8	9	90 NBR 109	N 1	16176 40421382	IP SP		● ●
	15	10	2,5	60 NBR A102	CPH	CC0020-C1	-	○	
	15	10	11	90 NBR 109	N 100	11909 40421103	IP SP		● ●
	16	6	7	90 NBR 109	N 1	16207 40421391	IP SP		● ●
18	6	7	90 NBR 109	N 1	16238 40421398	IP SP		● ●	
18	8	9	94 AU 925	AUN 1	14088 40421160	IP SP		● ●	
18	8	9	94 AU 925	AUN 100	11813 40421090	IP SP		● ●	
18	10	11	90 NBR 109	N 100	17580 40421527	IP SP		● ●	
19,3	4	4,2	PTFE B602 / NBR	OMK-E	24275926	IP		●	
19,3	4	4,2	PTFE GM201 / NBR	OMK-E	24276248	-		○	
19,3	4	4,2	PTFE B602 / FKM	OMK-E	24316411	-		○	
20	5	5,7	94 U801	ODI	FU0351-H0	-	○		
20	6	7	94 U801	ODI	FU0352-H0	-	○		

D [mm]	d [mm]	H [mm]	L [mm]	Material	Design	Part No.	PU ¹⁾	US	EU
30	20	8	9	94 AU 925	AUN 1	11817 40421091	IP SP	○	● ●
	20	8	9	94 AU 925	AUN 100	11829 40421093	IP SP		● ●
	20	8	9	90 NBR 109	N 1	16289 40421403	IP SP		● ●
	20	8	9	94 AU 925	NA 300	21679 40421664	– SP	○	● ●
	20	8	9	94 U801	ODI	FU0353-H0	–	○	
	20	10	11	94 AU 925	AUN 100	11830 40421094	IP SP		● ●
	20,5	4,3	4,5	19YF / 80 A980	SPG	GS0327-V0	–	○	
	21,5	3,8	4	19YF / 70 A305	SPGO	GS1802-V0	–	○	
	22	6	7	94 AU 925	AUN 1	11833 40421095	IP SP		● ●
	22	6	7	90 NBR 109	N 1	16321 40421408	IP SP		● ●
	22	19,9	19,9	80 NBR 878	SK 320	10605	IP		●
	22,4	5	5,7	94 U801	ODI	FU2139-H0	–	○	
	22,5	3	3,2	PTFE GM201 / NBR	OMK-MR	24131854	IP		●
	22,5	3	3,2	PTFE B602 / NBR	OMK-MR	24178460	IP		●
	22,5	3	3,2	PTFE B602 / FKM	OMK-MR	24300913	–		○
	22,5	3	3,2	PTFE C104 / NBR	OMK-MR	49030546	–		○
	22,5	3	3,2	98 AU 928	SK 300	416479	IP		●
	22,7	3	3,2	PTFE B602 / NBR	OMK-E	24378825	–		○
	22,7	3,2	3,2	PTFE GM201 / NBR	OMK-E	24174967	–		○
	22,8	3,8	4	PTFE 177023	TFMA	97436	IP	○	●
	23,8	4,3	4,8	PTFE F56110	FOA	366335	IP		●
	24	4,4	4,7	31BF / 70 A305	SPGC	GS1022-F0	–	○	
	24	5	6	90 NBR 109	N 1	16383 40421417	IP SP		● ●
	31	8	8	2	88 NBR 101	T OF	14901	–	
18		10	11	94 U801	ODI	FU2154-H0	–	○	
24		5	6	94 AU 925	AUN 1	11849 40421098	IP SP		● ●
24		5	6	90 NBR 109	N 1	16378 40421415	IP SP		● ●
25		4,4	4,7	31BF / 70 A305	SPGC	GS1023-F0	–	○	
31,5	14	10	2,4	94 U804	CPI	FC0022-C0	–	○	
	18,5	8	9	94 U801	ODI	FU0377-H0	–	○	
	18,5	10	11	94 U801	ODI	FU0378-H0	–	○	
	21,5	6	7	94 U801	ODI	FU0379-H0	–	○	
	21,5	8	9	94 U801	ODI	FU0380-H0	–	○	
	22	4,3	4,5	19YF / 80 A980	SPG	GS0328-V0	–	○	
	23	3,8	4	19YF / 70 A305	SPGO	GS1803-V0	–	○	
	23,5	5	5,7	94 U801	ODI	FU0381-H0	–	○	
25,5	4,4	4,7	31BF / 70 A305	SPGC	GS1024-F0	–	○		
32	6,2	11,5	1,8	88 NBR 101	T OF	14917	–		○
	10	10	11	90 NBR 109	N 1	16076	–		○
	12	10	3	88 NBR 101	T MF	14911	–		○
	14	10	11	90 NBR 109	N 1	16150	–		○
	16	8	2,5	88 NBR 101	T OF	14907	–		○
	16	8	9	94 AU 925	AUN 1	13680 40421150	IP SP		● ●
	16	8	9	90 NBR 109	N 1	16199 40421388	IP SP		● ●

D [mm]	d [mm]	H [mm]	L [mm]	Material	Design	Part No.	PU ¹⁾	US	EU
32	16	10	11	90 NBR 109	N 100	17802 40421548	IP SP		● ●
	16	11	12	90 NBR 109	N 1	16190	-		○
	17	10	11	94 AU 925	NA 300	21681 40421665	IP SP		● ●
	17	10	11	80 NBR 878	NA 400	25287	-		○
	18	7	2	88 NBR 101	T OF	14918 40421276	IP SP		● ●
	18	7	8	94 AU 925	AUN 1	14084 40421159	IP SP		● ●
	18	7	8	90 NBR 109	N 1	16234	-		○
	20	7,5	8,5	94 AU 925	AUN 1	14098 40421162	IP SP		● ●
	20	7,5	8,5	90 NBR 109	N 1	16297 40421406	IP SP		● ●
	20	8	9	94 AU 925	AUN 100	14404 40421240	IP SP		● ●
	20	10	11	80 NBR 878	NA 250	4429	-		○
	21	4	4,2	PTFE B602 / FKM	OMK-E	49062031	-		○
	21	4	4,2	PTFE B602 / NBR	OMK-E	49062042	-		○
	21	4	4,2	PTFE GM201 / NBR	OMK-E	49062044	-		○
	21	4	4,2	95 AU V142	OMK-PU	24341356	-		○
	21,3	4	4,2	PTFE B602 / NBR	OMK-E	24258449	-		○
	21,3	4	4,2	PTFE GM201 / NBR	OMK-E	24276370	-		○
	21,3	4	4,2	PTFE B602 / FKM	OMK-E	24345109	-		○
	22	5	6	90 NBR 109	N 1	16334 40421411	IP SP		● ●
	22	8	9	94 AU 925	AUN 100	11838 40421096	IP SP		● ●
	22	10	11	94 AU 925	NA 300	21682 40421666	IP SP		● ●
	22,5	4,3	4,5	19YF / 80 A980	SPG	GS0329-V0	-	○	
	23	5	6	90 NBR 109	N 1	16366 40421414	IP SP		● ●
	23,5	3,8	4	19YF / 70 A305	SPGO	GS1804-V0	-	○	
	24	4	4,7	90 NBR 109	N 1	16379 40421416	IP SP		● ●
	24	5	5,7	A505	OUHR	CU2683-Q2	-	○	
	24	5	5,7	A567	OUHR	CU2683-Q3	-	○	
	24	5,5	6	80 NBR 878	NA 150	84519 40421758	IP SP	○	● ●
	24	5,7	6,7	94 AU 925	NA 300	401144 40421941	IP SP		● ●
	24	7	8	94 AU 925	AUN 1	11850 40421099	IP SP		● ●
	24	9,3	10	95 AU V142	T 19	24306315	IP		●
	24	21,9	21,9	80 NBR 878	SK 320	10607	IP		●
24,5	2,95	3,2	PA 4112	HDP 330	49084151	IP		●	
24,5	3	3,2	PTFE B602 / NBR	OMK-E	24380941	-		○	
24,5	3	3,2	PTFE B602 / FKM	OMK-E	24380942	-		○	
24,5	3	3,2	PTFE GM201 / NBR	OMK-MR	24102892	IP		●	
24,5	3	3,2	PTFE B602 / NBR	OMK-MR	24178461	IP		●	
24,5	3	3,2	PTFE B602 / FKM	OMK-MR	24257477	-		○	
24,5	3	3,2	PTFE C104 / NBR	OMK-MR	49030548	-		○	
24,5	3	3,2	98 AU 928	SK 300	416480	IP	○	●	
24,8	3,8	4	PTFE 177023	TFMA	97878	IP		●	

D [mm]	d [mm]	H [mm]	L [mm]	Material	Design	Part No.	PU ¹⁾	US	EU
32	25,8	4,3	4,8	PTFE F56110	FOA	366336	IP		●
	26	4,4	4,7	31BF / 70 A305	SPGC	GS1025-F0	-	○	
33	20	6	7	90 NBR 109	N 1	16293 40421404	IP SP		● ●
	20	10	11	94 U801	ODI	FU2155-H0	-	○	
	25	5	5,7	94 U801	ODI	FU2140-H0	-	○	
	25	7	8	90 NBR 109	N 1	16400 40421424	IP SP	○	● ●
	25,5	2,9	3,2	PA 4112	HDP 330	49055231	-		○
	25,5	3	3,2	PTFE B602 / NBR	OMK-MR	24301061	-		○
34	12	10	11	90 NBR 109	N 1	16112	-		○
	18	8	9	94 AU 925	AUN 1	11808	-		○
	18	8	9	90 NBR 109	N 1	16227	-		○
	18	10	3	88 NBR 101	T OF	14928	-		○
	19	8	9	90 NBR 109	N 1	16272 40421399	IP SP		● ●
	22	6	7	94 AU 925	AUN 1	11832	-		○
	22	6	7	90 NBR 109	N 1	16333 40421410	IP SP		● ●
	22	10	11	90 NBR 109	N 100	17846 40421550	IP SP		● ●
	24	5	6	90 NBR 109	N 1	16384 40421418	IP SP		● ●
	26,5	3	3,2	PA 4112	HDP 330	49055251	IP		●
	26,5	3	3,2	PTFE GM201 / NBR	OMK-MR	24231120	-		○
	26,5	3	3,2	PTFE GM201 / FKM	OMK-MR	24356421	-		○
	26,5	3	3,2	PTFE B602 / NBR	OMK-MR	49005393	-		○
	26,5	3	3,2	PTFE C104 / NBR	OMK-MR	49014548	-		○
28	4,4	4,7	31BF / 70 A305	SPGC	GS1026-F0	-	○		
35	0	9	2,5	88 NBR 101	T OF	14942 40421278	IP SP		● ●
	8	26		90 NBR 109	TDUOH	9634	IP		●
	10	8	2,5	88 NBR 101	T OF	14937	-		○
	10	10	3	88 NBR 101	T MF	14946	-		○
	10	12	3	88 NBR 101	T OF	14943 40421279	IP SP		● ●
	14	10	4	88 NBR 101	T OF	14947	-		○
	15	10	11	90 NBR 109	N 1	16173	-		○
	16	9	10	94 AU 925	AUN 1	14076	-		○
	16	10	2,4	94 U805	CPI	FC0026-C0	-	○	
	17	6	1,5	88 NBR 101	T MF	8387	-		○
	17	6	1,5	88 NBR 101	T OF	14944	-		○
	17	10	11	94 AU 925	AUN 1	14080	-		○
	18	8,5	9,5	94 AU 925	AUN 1	14086	-		○
	18	8,5	9,5	90 NBR 109	N 1	16241	-		○
	18	10	2,5	60 NBR A102	CPH	CC0026-C0	-	○	
	18	12	13	90 NBR 109	N 100	17807	-		○
	20	10	11	90 NBR 109	N 1	17965 40421567	IP SP		● ●
	20	10	11	90 NBR 109	N 100	16314 40421407	IP SP		● ●
	21	8	2,5	88 NBR 101	T OF	14941 40421277	IP SP		● ●
	22	7	8	90 NBR 109	N 1	16340 40421413	IP SP		● ●

D [mm]	d [mm]	H [mm]	L [mm]	Material	Design	Part No.	PU ¹⁾	US	EU	
35	22	8	9	94 AU 925	AUN 1	14106 40421163	IP SP		● ●	
	22	10	11	94 AU 925	AUN 100	14349 40421207	IP SP		● ●	
	22	10	11	80 NBR 878	NA 250	18426	-		○	
	22	10	11	94 U801	ODI	FU2156-H0	-	○		
	23	10	11	94 AU 925	AUN 1	11844 40421097	IP SP		● ●	
	23	10	11	90 NBR 109	N 1	16364	-		○	
	24	4	4,2	98 AU 928	SK 300	410747	-		○	
	24,3	4	4,2	PTFE B602 / NBR	OMK-E	24257786	-		○	
	24,3	4	4,2	PTFE GM201 / NBR	OMK-E	24276369	-		○	
	24,3	4	4,2	PTFE B602 / FKM	OMK-E	24339868	-		○	
	25	5	6	94 AU 925	AUN 1	11856 40421102	IP SP		● ●	
	25	5	6	90 NBR 109	N 1	16399 40421423	IP SP		● ●	
	25	6	7	94 U801	ODI	FU0418-H0	-	○		
	25	7,3	8,3	94 AU 925	NA 300	401159 40421942	IP SP		● ●	
	25	8	9	94 AU 925	AUN 1	11854 40421101	IP SP		● ●	
	25	8	9	94 AU 925	AUN 100	12304 40421113	IP SP		● ●	
	25	8	9	90 NBR 109	N 1	18116 40421579	IP SP		● ●	
	25	8	9	94 U801	ODI	FU0419-H0	-	○		
	25,5	4,3	4,5	19YF / 80 A980	SPG	GS0330-V0	-	○		
	26,5	3,8	4	19YF / 70 A305	SPGO	GS1805-V0	-	○		
	27	5	5,7	94 U801	OSI	FU0420-L0	-	○		
	27	21,9	21,9	80 NBR 878	SK 320	10613	IP		●	
	27,5	3	3,2	PTFE GM201 / NBR	OMK-MR	24106354	IP		●	
	27,5	3	3,2	PTFE B602 / NBR	OMK-MR	24178462	IP		●	
	27,5	3	3,2	PTFE B602 / FKM	OMK-MR	24300835	-		○	
	27,5	3	3,2	PTFE C104 / NBR	OMK-MR	49005012	-		○	
	27,8	3,8	4	PTFE 177023	TFMA	98405	IP		●	
	28,8	4,3	4,8	PTFE F56110	FOA	371930	IP		●	
	29	4,4	4,7	31BF / 70 A305	SPGC	GS1027-F0	-	○		
	35,4	22,4	10	11	94 U801	ODI	FU2157-H0	-	○	
	35,5	16	10	2,4	94 U806	CPI	FC0398-C0	-	○	
		22,5	8	9	94 U801	ODI	FU0446-H0	-	○	
22,5		10	11	94 U801	ODI	FU0447-H0	-	○		
25,5		6	7	94 U801	ODI	FU0448-H0	-	○		
25,5		8	9	94 U801	ODI	FU0449-H0	-	○		
26		4,3	4,5	19YF / 80 A980	SPG	GS0331-V0	-	○		
27		3,8	4	19YF / 70 A305	SPGO	GS1806-V0	-	○		
27,5		5	5,7	94 U801	OSI	FU0450-L0	-	○		
28		5	5,7	94 U801	OSI	FU2141-L0	-	○		
29,5		4,4	4,7	31BF / 70 A305	SPGC	GS1028-F0	-	○		
36	12	10	3	88 NBR 101	T MF	14955	-		○	
	16	10	11	90 NBR 109	N 1	16197	-		○	
	18	6	2	88 NBR 101	T OF	14954	-		○	
	20	8	9	94 AU 925	AUN 1	14378 40421234	IP SP		● ●	

D [mm]	d [mm]	H [mm]	L [mm]	Material	Design	Part No.	PU ¹⁾	US	EU
36	20	8	9	90 NBR 109	N 1	16279 40421401	IP SP		● ●
	20	10	11	90 NBR 109	N 100	17857	-		○
	22	8	9	90 NBR 109	N 1	16341	-		○
	25,3	4	4,2	PTFE B602 / NBR	OMK-E	24276021	-		○
	25,3	4	4,2	PTFE GM201 / NBR	OMK-E	24276364	-		○
	25,3	4	4,2	PTFE B602 / FKM	OMK-E	24345110	-		○
	27	6	7	90 NBR 109	N 1	16444 40421427	IP SP		● ●
	28,5	3	3,2	PTFE GM201 / NBR	OMK-MR	24131855	-		○
	28,5	3	3,2	PTFE B602 / NBR	OMK-MR	24178463	IP		●
	28,5	3	3,2	PTFE B602 / FKM	OMK-MR	24348357	-		○
36,5	30	4,4	4,7	31BF / 70 A305	SPGC	GS1029F0	-	○	
	29	3	3,2	PTFE B602 / FKM	OMK-MR	24274964	-		○
37	24	6	7	90 NBR 109	N 1	16386 40421419	IP SP		● ●
	26	7	1,5	88 NBR 101	T OF	14966	-		○
	30	8	9	94 AU 925	AUN 1	12319 40421115	IP SP		● ●
	30	8	9	90 NBR 109	N 1	16487 40421434	IP SP		● ●
	31	4,4	4,7	31BF / 70 A305	SPGC	GS1030F0	-	○	
37,5	31,5	4,4	4,7	31BF / 70 A305	SPGC	GS1031F0	-	○	
38	12	8	2,5	88 NBR 101	T OF	14969	-		○
	16	8	2,5	88 NBR 101	T OF	14970 40421280	IP SP		● ●
	18	10	11	90 NBR 109	N 1	16228 40421393	IP SP		● ●
	22	8	9	90 NBR 109	N 1	16324 40421409	IP SP		● ●
	22	10	11	90 NBR 109	N 100	17934 40421562	IP SP		● ●
	25	7	8	90 NBR 109	N 1	16401 40421425	IP SP		● ●
	25	10	11	94 AU 925	AUN 100	14351 40421208	IP SP		● ●
	25	10	11	80 NBR 878	NA 250	18429	-		○
	25	10	11	94 AU 925	NA 300	401189	-		○
	25	10	11	94 U801	ODI	FU0466-H0	-	○	
	26	6	7	90 NBR 109	N 1	16428 40421426	IP SP		● ●
	27,3	4	4,2	PTFE B602 / NBR	OMK-E	24275930	-		○
	27,3	4	4,2	PTFE GM201 / NBR	OMK-E	24276251	-		○
	27,3	4	4,2	PTFE B602 / FKM	OMK-E	24345111	-		○
	28	5	6	90 NBR 109	N 1	16461 40421430	IP SP		● ●
	28	8	9	94 AU 925	AUN 1	14131 40421166	IP SP		● ●
	30,5	3	3,2	PA 4112	HDP 330	49055272	IP	○	●
	30,5	3	3,2	PTFE GM201 / NBR	OMK-MR	24193507	-		○
	30,5	3	3,2	PTFE B602 / NBR	OMK-MR	24260938	-		○
30,5	3	3,2	PTFE C104 / NBR	OMK-MR	49036117	-		○	
30,8	3,8	4	PTFE 177023	TFMA	94313	-		○	
32	4,4	4,7	31BF / 70 A305	SPGC	GS1032F0	-	○		
38,1	0	9,4	3	88 NBR 101	T OF	14984 40421281	IP SP		● ●

D [mm]	d [mm]	H [mm]	L [mm]	Material	Design	Part No.	PU ¹⁾	US	EU
40	0	6	2	88 NBR 101	T OF	14995 40421283	IP SP		● ●
	0	10	2	88 NBR 101	T MF	14992	-		○
	10	25		90 NBR 109	TDUOH	9640	IP		●
	13	13	4	88 NBR 101	T OF	14999 40421285	IP SP	○	● ●
	16	8	2,5	80 NBR 104	CPH	CC0034-C1	-	○	
	16	10	2	88 NBR 101	T OF	15000 40421286	IP SP		● ●
	18	6	2	88 NBR 101	T OF	14994 40421282	IP SP		● ●
	18	15	3	88 NBR 101	T MF	15003 40421287	IP SP		● ●
	20	10	2,4	94 U807	CPI	FC0035-C0	-	○	
	20	10	2,5	60 NBR A102	CPH	CC0035-C0	-	○	
	20	10	11	94 AU 925	AUN 1	14091 40421161	IP SP		● ●
	20	10	11	90 NBR 109	N 1	16288 40421402	IP SP		● ●
	20	12	13	90 NBR 109	N 100	17933 40421561	IP SP		● ●
	21	9	3	88 NBR 101	T OF	14998 40421284	IP SP		● ●
	22	10	11	94 AU 925	AUN 1	14104	-		○
	22	10	11	90 NBR 109	N 1	16322	-		○
	24	8	2	88 NBR 101	T OF	15004	-	○	○
	24	8	9	94 AU 925	AUN 1	14255 40421184	IP SP		● ●
	24	8	9	90 NBR 109	N 1	16377	-		○
	24	10	11	90 NBR 109	N 100	17664 40421531	IP SP		● ●
	24	18,4	18,4	80 NBR B281	L 43	24251786	IP		●
	24,5	6	6,3	98 AU 928	SK 300	416483	-		○
	25	6	7	90 NBR 109	N 1	16397 40421422	IP SP		● ●
	25	9	10	94 U801	ODI	FU0485-H0	-	○	
	25	9,3	9,5	95 AU V142	T 18	24245851	IP		●
	25	9,3	10	95 AU V142	T 18	24245876	IP		●
	25	10	11	94 AU 925	AUN 100	14391 40421237	IP SP		● ●
	25	10	11	90 NBR 109	N 100	17762 40421543	IP SP		● ●
	25	10	11	80 NBR 878	NA 250	18432	IP		●
	25	10	11	94 AU 925	NA 300	21691 40421667	IP SP		● ●
	25	10	11	80 NBR 878	NA 400	25289	-		○
	25	10	11	94 U801	ODI	FU0486-H0	-	○	
	25	11	11,5	BHNBR B3B246	EK	24070153	IP		●
	25	11	11,5	BHFKM B3K674	EKV	24101339	IP		●
	25	11	12	94 AU 925	AUN 1	11853 40421100	IP SP		● ●
	26	15,5	15,5	80 NBR B281	L 43	24251780	IP		●
	27	8	9	94 U801	ODI	FU0488-H0	-	○	
	27	10	11	94 U801	ODI	FU0489-H0	-	○	
	28	10	11	94 AU 925	AUN 100	14352 40421209	- SP	○	● ●
	29	3,95	4,2	PA 4112	HDP 330	49066777	IP		●

D [mm]	d [mm]	H [mm]	L [mm]	Material	Design	Part No.	PU ¹⁾	US	EU
	29	4	4,2	PTFE B602 / FKM	OMK-E	49062045	-		○
	29	4	4,2	PTFE B602 / NBR	OMK-E	49062046	-		○
	29	4	4,2	PTFE GM201 / NBR	OMK-E	49062047	-		○
	29	4	4,2	PTFE GM201 / NBR	OMK-MR	24106357	IP		●
	29	4	4,2	PTFE B602 / NBR	OMK-MR	24178464	IP		●
	29	4	4,2	PTFE B602 / FKM	OMK-MR	24260917	IP		●
	29	4	4,2	PTFE GM201 / FKM	OMK-MR	24262348	-		○
	29	4	4,2	PTFE C104 / NBR	OMK-MR	49013955	-		○
	29	4	4,2	95 AU V142	OMK-PU	24341357	-		○
	29	4	4,2	98 AU 928	SK 300	416481	IP		●
	29,3	4	4,2	PTFE B602 / NBR	OMK-E	24249194	IP		●
	29,3	4	4,2	PTFE GM201 / NBR	OMK-E	24276367	-		○
	29,3	4	4,2	PTFE B602 / FKM	OMK-E	24316410	IP		●
	30	4,3	4,5	19YF / 80 A980	SPG	GS0332-V0	-	○	
	30	5	6	94 AU 925	AUN 1	12322 40421116	IP SP		● ●
	30	5	6	90 NBR 109	N 1	16493 40421436	IP SP		● ●
	30	6	7	94 U801	OSI	FU0490-L0	-	○	
	30	6	7	A505	OUHR	CU2684-Q3	-	○	
	30	6	7	A567	OUHR	CU2684-Q5	-	○	
40	30	6	7	94 U641	OUIS	FU0490-P0	-	○	
	30	6	7	94 U801	OUIS	FU0490-P1	-	○	
	30	7	7,5	80 NBR 878	NA 150	84520 40421759	IP SP	○	● ●
	30	8	9	94 U801	ODI	FU0491-H0	-	○	
	30	10	11	94 AU 925	AUN 100	14353 40421210	- SP	○	● ●
	30	10	11	94 AU 925	NA 300	21692 40421668	IP SP		● ●
	30	16,4	16,4	80 NBR B281	L 43	529742	-		○
	31,5	3,8	4	19YF / 70 A305	SPGO	GS1807-V0	-	○	
	32	4	4,7	90 NBR 109	N 1	16510 40421440	IP SP		● ●
	32	7	8	90 NBR 109	N 1	16517 40421445	IP SP		● ●
	32	9	9,5	80 NBR 878	SK 520	141475	IP		●
	32	9,3	10	95 AU V142	T 19	24264801	IP		●
	32	21,9	21,9	80 NBR 878	SK 320	10618	IP	○	●
	32,7	3	3,2	PTFE B602 / NBR	OMK-E	49009352	-		○
	32,8	3,8	4	PTFE 177023	TFMA	97022	IP		●
	33,8	4,3	4,8	PTFE F56110	FOA	366337	IP		●
	34	4,4	4,7	31BF / 70 A305	SPGC	GS1033-F0	-	○	
41	18	18	5	88 NBR 101	T OF	15018	-		○
	28	10	11	94 U801	ODI	FU2158-H0	-	○	
	30	8	9	90 NBR 109	N 1	16497	-		○
	35	4,4	4,7	31BF / 70 A305	SPGC	GS1034-F0	-	○	
41,5	31,5	6	7	94 U801	OSI	FU2142-L0	-	○	
	35,5	4,4	4,7	31BF / 70 A305	SPGC	GS1035-F0	-	○	
42	16,2	6	2	88 NBR 101	T OF	15021 40421288	IP SP		● ●
	22	10	11	80 NBR 878	NA 250	32166	-		○
	23	12	3	90 NBR A505	CPH	CC0040-C0	-	○	
	25	8,5	9,5	94 AU 925	AUN 1	14116 40421165	IP SP		● ●

D [mm]	d [mm]	H [mm]	L [mm]	Material	Design	Part No.	PU ¹⁾	US	EU
42	25	8,5	9,5	90 NBR 109	N 1	16395 40421421	IP SP		● ●
	25	13	2,5	88 NBR 101	T OF	15022 40421289	IP SP		● ●
	26	8	9	90 NBR 109	N 1	16422	-		○
	30	10	11	94 AU 925	AUN 100	14354 40421211	IP SP		● ●
	30	10	11	90 NBR 109	N 100	17782 40421545	IP SP		● ●
	30	10	11	80 NBR 878	NA 250	18434	-		○
	31	4	4,2	PTFE GM201 / NBR	OMK-MR	24131856	IP		●
	31	4	4,2	PTFE B602 / NBR	OMK-MR	24178465	IP		●
	31	4	4,2	PTFE B602 / FKM	OMK-MR	24306482	-		○
	31,3	4	4,2	PTFE B602 / NBR	OMK-E	24275932	-		○
	31,3	4	4,2	PTFE GM201 / NBR	OMK-E	24276253	-		○
	31,3	4	4,2	PTFE B602 / FKM	OMK-E	24345112	-		○
	34,8	3,8	4	PTFE 177023	TFMA	98536	IP		●
	35,8	4,3	4,8	PTFE F56110	FOA	434448	IP		●
	36	4,4	4,7	31BF / 70 A305	SPGC	GS1036F0	-	○	
42,5	35,2	3	3,2	PTFE GM201 / NBR	OMK-E	49004234	-		○
43	15	10	3	88 NBR 101	T OF	15027 40421290	IP SP		● ●
	23	10	11	90 NBR 109	N 1	16363	-		○
	30	10	11	94 U801	ODI	FU2159H0	-	○	
	32	4	4,2	PTFE B602 / NBR	OMK-MR	24308874	-		○
44	33	6	7	90 NBR 109	N 1	16534 40421446	IP SP		● ●
	24	10	11	90 NBR 109	N 1	16385	-		○
	28	8	9	94 AU 925	AUN 1	12310	-		○
	28	8	9	90 NBR 109	N 1	16464 40421431	IP SP		● ●
	32	6	7	90 NBR 109	N 1	16512 40421442	IP SP		● ●
	33	4	4,2	PTFE B602 / NBR	OMK-MR	24244703	-		○
	33	4	4,2	PTFE GM201 / NBR	OMK-MR	24355423	-		○
44,5	38	4,4	4,7	31BF / 70 A305	SPGC	GS1037F0	-	○	
	31,5	10	11	94 U801	ODI	FU2160H0	-	○	
	33,5	4	4,2	PTFE GM201 / FKM	OMK-MR	24300837	-		○
45	33,5	4	4,2	PTFE B602 / FKM	OMK-MR	24300874	-		○
	10	25		90 NBR 109	TDUOH	9651 9651-SIM	IP -	○	●
	20	10	3	88 NBR 101	T OF	15045 40421293	IP SP		● ●
	20	12	2,9	94 U808	CPI	FC0046-C0	-	○	
	20	12	13	94 AU 925	AUN 1	14093	-		○
	20	12	13	90 NBR 109	N 1	17458 40421525	IP SP		● ●
	22	14	4	88 NBR 101	T OF	15038	-		○
	25	10	2,5	60 NBR A102	CPH	CC0044-C0	-	○	
	25	10	2,5	88 NBR 101	T MF	15040 40421292	IP SP		● ●
	25	10	11	94 AU 925	AUN 1	11852	-		○
	25	10	11	90 NBR 109	N 1	16393 40421420	IP SP		● ●
	25	12	13	90 NBR 109	N 100	17892 40421556	IP SP		● ●
	26,5	18	3	88 NBR 101	T OF	15044	-		○

D [mm]	d [mm]	H [mm]	L [mm]	Material	Design	Part No.	PU ¹⁾	US	EU
	27	10	2,5	88 NBR 101	T OF	15047 40421294	IP SP		● ●
	29	8	9	90 NBR 109	N 1	16479	-		○
	30	6	1,5	88 NBR 101	T OF	15048	-		○
	30	9	10	94 U801	ODI	FU0559-H0	-	○	
	30	9,3	9,5	95 AU V142	T 18	24245852	IP	○	●
	30	9,3	10	95 AU V142	T 18	24245877	IP		●
	30	10	11	94 AU 925	AUN 1	12317 40421114	IP SP		● ●
	30	10	11	94 AU 925	AUN 100	14355 40421212	IP SP		● ●
	30	10	11	90 NBR 109	N 1	16490 40421435	IP SP		● ●
	30	10	11	90 NBR 109	N 100	17694 40421534	IP SP		● ●
	30	10	11	80 NBR 878	NA 250	18436	-		○
	30	10	11	94 AU 925	NA 300	362912 40421931	IP SP		● ●
	30	10	11	80 NBR 878	NA 400	4561	IP		●
	30	10	11	94 U801	ODI	FU0560-H0	-	○	
	30	11	11,5	BHNBR B3B246	EK	24070155	-		○
	30	11	11,5	BHFKM B3K674	EKV	24148048	-		○
	31	15,5	15,5	80 NBR B281	L 43	24265145	IP		●
	32	6,5	7,5	94 AU 925	AUN 1	14147	-		○
	32	6,5	7,5	90 NBR 109	N 1	16511 40421441	IP SP		● ●
	32	8	9	94 U801	ODI	FU0561-H0	-	○	
45	32	10	11	94 AU 925	AUN 100	14356 40421213	IP SP		● ●
	32	10	11	90 NBR 109	N 100	17547 40421526	IP SP		● ●
	32	10	11	94 U801	ODI	FU0562-H0	-	○	
	34	4	4,2	PA 4112	HDP 330	49055273	IP	○	●
	34	4	4,2	PTFE GM201 / NBR	OMK-MR	24108643	IP		●
	34	4	4,2	PTFE B602 / NBR	OMK-MR	24178466	IP		●
	34	4	4,2	PTFE GM201 / FKM	OMK-MR	24236601	-		○
	34	4	4,2	PTFE B602 / FKM	OMK-MR	24348358	IP		●
	34	4	4,2	95 AU V142	OMK-PU	24341025	-		○
	34	4	4,2	98 AU 928	SK 300	416484	IP		●
	34	4,2	4,2	PTFE C104 / NBR	OMK-MR	49021489	-		○
	34	7	8	94 AU 925	AUN 1	12341	-		○
	34,3	4	4,2	PTFE B602 / FKM	OMK-E	24269472	-		○
	34,3	4	4,2	PTFE B602 / NBR	OMK-E	24275914	IP		●
	34,3	4	4,2	PTFE GM201 / NBR	OMK-E	24276236	-		○
	35	4,3	4,5	19YF / 80 A980	SPG	GS0333-V0	-	○	
	35	6	7	90 NBR 109	N 1	16547 40421447	IP SP		● ●
	35	6	7	90 NBR 109	N 1	16552 40421450	IP SP		● ●
	35	6	7	94 U801	OSI	FU0563-L0	-	○	
	35	6	7	94 U641	OUIS	FU0563-P0	-	○	
	35	6	7	94 U801	OUIS	FU0563-P1	-	○	
	35	8	9	94 AU 925	AUN 1	12344 40421117	IP SP		● ●
	35	8	9	94 U801	ODI	FU0564-H0	-	○	

D [mm]	d [mm]	H [mm]	L [mm]	Material	Design	Part No.	PU ¹⁾	US	EU
45	35	10	11	94 AU 925	AUN 100	14357 40421214	IP SP		● ●
	35,5	6	7	94 U801	OSI	FU2143-L0	-	○	
	36,5	3,8	4	19YF / 70 A305	SPGO	GS1808-V0	-	○	
	37	21,9	21,9	80 NBR 878	SK 320	10636	IP		●
	37,7	3	3,2	PTFE B602 / NBR	OMK-E	24378828	-		○
	37,8	3,8	4	PTFE 177023	TFMA	97023	IP		●
	38,8	4,3	4,8	PTFE F56110	FOA	371448	IP		●
	39	4	4,7	90 NBR 109	N 1	16600	-		○
	39	4,4	4,7	31BF / 70 A305	SPGC	GS1038-F0	-	○	
46	0	10	2	88 NBR 101	T OF	15061	-		○
	11	9	1,5	88 NBR 101	T OF	15059 40421295	IP SP		● ●
	22	12	13	90 NBR 109	N 1	16332	-		○
	27	11	3,5	88 NBR 101	T OF	15060	-		○
	28	10	11	94 AU 925	AUN 1	14127	-		○
	28	10	11	90 NBR 109	N 1	16456 40421428	IP SP		● ●
	35	4	4,2	PTFE B602 / NBR	OMK-MR	49037746	-		○
	36	6	7	90 NBR 109	N 1	16571 40421455	IP SP		● ●
	40	4	4,7	90 NBR 109	N 1	16619 40421461	IP SP		● ●
40	4,4	4,7	31BF / 70 A305	SPGC	GS1039-F0	-	○		
47	41	4,4	4,7	31BF / 70 A305	SPGC	GS1040-F0	-	○	
48	28	10	11	90 NBR 109	N 1	16459 40421429	IP SP		● ●
	28	12	13	90 NBR 109	N 100	17916 40421560	IP SP		● ●
	28	12	13	94 AU 925	NA 300	401210	-		○
	30	9	2,5	88 NBR 101	T OF	15076 40421296	IP SP		● ●
	30	9	10	90 NBR 109	N 1	16496	-		○
	32	8	9	90 NBR 109	N 1	16506 40421438	IP SP		● ●
	32	8	9	90 NBR 109	N 1	16514 40421443	IP SP		● ●
	35	10	11	94 AU 925	AUN 100	12262 40421110	IP SP		● ●
	35	10	11	94 AU 925	NA 300	401230	-		○
	36	6	7	90 NBR 109	N 1	16568 40421454	IP SP		● ●
	37	4	4,2	PTFE GM201 / NBR	OMK-MR	24251038	IP		●
	37	4	4,2	PTFE B602 / NBR	OMK-MR	24301063	-		○
	37	4	4,2	PTFE C104 / NBR	OMK-MR	49021959	-		○
	37,3	4	4,2	PTFE B602 / NBR	OMK-E	24275934	-		○
	37,3	4	4,2	PTFE GM201 / NBR	OMK-E	24276255	-		○
	37,3	4	4,2	PTFE B602 / FKM	OMK-E	24345113	-		○
	38,6	6,6	7,1	PTFE F56110	FOA	422093	-		○
40	8	9	90 NBR 109	N 1	16629 40421464	IP SP		● ●	
40,8	3,8	4	PTFE 177023	TFMA	98537	-	○	○	
42	4,4	4,7	31BF / 70 A305	SPGC	GS1041-F0	-	○		
50	0	12	3	88 NBR 101	T MF	15103 40421301	IP SP		● ●
	0	15	4,5	88 NBR 101	T OF	15101 40421300	IP SP		● ●
	6	7	2	88 NBR 101	T OF	15097	-		○

D [mm]	d [mm]	H [mm]	L [mm]	Material	Design	Part No.	PU ¹⁾	US	EU
	8	12	3	88 NBR 101	T OF	15088	-		○
	10	25		90 NBR 109	TDUOH	9654 965456	IP -	○	●
	10,5	18	3,5	88 NBR 101	T MF	15086	-		○
	12	10	2,5	88 NBR 101	T OF	15092	-		○
	16	19	4	88 NBR 101	T OF	15089	-		○
	16	23		90 NBR 109	TDUOH	9656	-		○
	18	10	2	88 NBR 101	T OF	15096 40421299	IP SP		● ●
	22	12	2,9	94 U809	CPI	FC0055-C0	-	○	
	24	12	13	94 AU 925	AUN 1	14111 40421164	IP SP		● ●
	24	12	13	90 NBR 109	N 1	16380	-		○
	25	12	3	80 NBR 104	CPH	CC0055-C1	-	○	
	25	12	3	88 NBR 101	T OF	15099	-		○
	25	12	13	94 AU 925	AUN 1	14115	-		○
	25	12	13	90 NBR 109	N 1	16391	-		○
	25,4	12	2,5	88 NBR 101	T MF	15095 40421298	IP SP	○	● ●
	28	7	2	88 NBR 101	T OF	15094	-		○
	28	12	3	88 NBR 101	T OF	15105	-		○
	30	10	11	94 AU 925	AUN 1	14137 40421167	IP SP		● ●
	30	10	11	90 NBR 109	N 1	16486 40421433	IP SP		● ●
	30	12	13	94 AU 925	AUN 100	14141 40421168	IP SP		● ●
50	30	12	13	90 NBR 109	N 100	16504 40421437	IP SP		● ●
	30	12	13	80 NBR 878	NA 250	18443	-		○
	30	12	13	94 AU 925	NA 300	21701 40421669	IP SP		● ●
	30	12	13	80 NBR 878	NA 400	25325	IP	○	●
	32	7	2	88 NBR 101	T OF	15083 40421297	IP SP		● ●
	32	10	11	94 AU 925	AUN 1	14149 40421169	IP SP		● ●
	32	10	11	90 NBR 109	N 1	16516 40421444	IP SP		● ●
	32	12	13	90 NBR 109	N 100	17784 40421547	IP SP		● ●
	34	10	11	94 U801	ODI	FU0608-H0	-	○	
	34	12	13	94 U801	ODI	FU0609-H0	-	○	
	34	18,4	18,4	80 NBR B281	L 43	24251792	IP		●
	34	20,5	20,5	80 NBR B281	L 43	24251797	IP		●
	34,5	6	6,3	95 AU V142	OMK-PU	24341045	-		○
	34,5	6	6,3	98 AU 928	SK 300	416486 1674004	IP -	●	●
	35	7,2	10	PTFE GM201	OMK-S	24096095	-		○
	35	8	9	90 NBR 109	N 1	16553 40421451	- SP	○	● ●
	35	9	10	94 U801	ODI	FU0610-H0	-	○	
	35	9,3	9,5	95 AU V142	T 18	24245853	IP		●
	35	9,3	10	95 AU V142	T 18	24245878	IP		●
	35	10	11	94 AU 925	AUN 100	14390 40421236	- SP	○	● ●

D [mm]	d [mm]	H [mm]	L [mm]	Material	Design	Part No.	PU ¹⁾	US	EU
50	35	10	11	90 NBR 109	N 100	17910 40421558	IP SP		● ●
	35	10	11	80 NBR 878	NA 250	18442	IP		●
	35	10	11	94 AU 925	NA 300	21705 40421670	IP SP		● ●
	35	10	11	80 NBR 878	NA 400	25306	IP		●
	35	10	11	94 U801	ODI	FU0611-H0	-	○	
	35	11	11,5	BHNBR B3B246	EK	24070156	IP		●
	35	11	11,5	BHFKM B3K674	EKV	24139300	IP		●
	35	12	13	94 U801	ODI	FU2161-H0	-	○	
	36	7	2	88 NBR 101	T OF	15090	-		○
	36	7	8	90 NBR 109	N 1	16573 40421456	IP SP		● ●
	36	8,5	9	19YF / 80 NBR A980 / PA 12NM	SPGW	GS0535-V5	-	○	
	38	6	1,5	88 NBR 101	T OF	15098	-		○
	38	6	7	90 NBR 109	N 1	16586 40421457	IP SP		● ●
	38	9	10	94 AU 925	AUN 1	13758 40421152	- SP	○	● ●
	38	9	10	PTFE B602	L 27	24361313	IP		●
	38	11	11,5	80 NBR 878	SK 520	316637	-		○
	38	14	14,5	80 NBR 878	SK 520	125346	IP		●
	38	28,9	28,9	80 NBR 878	SK 320	10642	IP		●
	39	3,95	4,2	PA 4112	HDP 330	49036076	IP		●
	39	4	4,2	PTFE B602 / FKM	OMK-E	49062048	-		○
	39	4	4,2	PTFE B602 / NBR	OMK-E	49062049	-		○
	39	4	4,2	PTFE GM201 / NBR	OMK-E	49062062	-		○
	39	4	4,2	PTFE GM201 / NBR	OMK-MR	24109476	IP		●
	39	4	4,2	PTFE GM201 / FKM	OMK-MR	24170829	-		○
	39	4	4,2	PTFE B602 / NBR	OMK-MR	24178467	IP		●
	39	4	4,2	PTFE B602 / FKM	OMK-MR	24246484	IP		●
	39	4	4,2	95 AU V142	OMK-PU	24341050	-		○
	39	4	4,2	98 AU 928	SK 300	417293	IP		●
	39	4,2	4,2	PTFE C104 / NBR	OMK-MR	49015912	-		○
	39,3	4	4,2	PTFE GM201 / NBR	OMK-E	24258849	-		○
	39,3	4	4,2	PTFE B602 / NBR	OMK-E	24258850	IP		●
	39,3	4	4,2	PTFE B602 / FKM	OMK-E	24345114	-		○
	40	4,3	4,5	19YF / 80 A980	SPG	GS0334-V0	-	○	
	40	5	6	90 NBR 109	N 1	16615 40421460 1661535	IP SP -		● ●
	40	6	7	94 U801	OSI	FU0613-L0	-	○	
	40	6	7	A505	OUHR	CU2604-Q3	-	○	
	40	6	7	A567	OUHR	CU2604-Q4	-	○	
	40	6	7	94 U641	OUIS	FU0613-P0	-	○	
	40	6	7	94 U801	OUIS	FU0613-P1	-	○	
	40	7	7,5	80 NBR 878	NA 150	84521 40421760	IP SP		● ●
40	8	9	94 AU 925	AUN 1	14179 40421176	IP SP		● ●	
40	8	9	94 U801	ODI	FU0614-H0	-	○		
40	9	10	90 NBR 109	N 100	18024 40421572	IP SP		● ●	

D [mm]	d [mm]	H [mm]	L [mm]	Material	Design	Part No.	PU ¹⁾	US	EU
50	40	10	11	94 AU 925	AUN 100	14398 40421238	– SP	○	● ●
	40	10	11	94 AU 925	NA 300	21710 40421671	IP SP		● ●
	40	11,6	12,5	95 AU V142	T 19	24269657	IP		●
	40,6	6,6	7,1	PTFE F56110	FOA	366338	IP		●
	41,5	3,8	4	19YF / 70 A305	SPGO	GS1809-V0	–	○	
	42	6	7	90 NBR 109	N 1	16654 40421468 1665464	IP SP –	○	● ●
	42,8	3,8	4	PTFE 177023	TFMA	96867	IP		●
	44	4,4	4,7	31BF / 70 A305	SPGC	GS1042-F0	–	○	
51	35	8	9	90 NBR 109	N 1	16549 40421448	IP SP		● ●
	45	4,4	4,7	31BF / 70 A305	SPGC	GS1043-F0	–	○	
51,5	35,5	12	13	94 U801	ODI	FU2162-H0	–	○	
51,6	40,6	4	4,2	PTFE GM201 / NBR	OMK-MR	24217901	–		○
52	20	8	2,5	88 NBR 101	T OF	15122	–		○
	32	10	11	94 AU 925	AUN 1	14145	–		○
	32	10	11	90 NBR 109	N 1	16508 40421439	IP SP		● ●
	35	12	13	90 NBR 109	N 100	18074 40421578	IP SP		● ●
	40	8	9	90 NBR 109	N 1	16627 40421463	IP SP		● ●
	41	4	4,2	PTFE B602 / NBR	OMK-MR	24288829	–		○
	44,8	3,8	4	PTFE 177023	TFMA	98538	–		○
	45	8	9	90 NBR 109	N 1	16672 40421470	IP SP		● ●
	46	4,4	4,7	31BF / 70 A305	SPGC	GS1044-F0	–	○	
	53	25	12	2,9	94 U810	CPI	FC0064-C0	–	○
53	42	4	4,2	PTFE B602 / NBR	OMK-MR	24290123	–		○
	44,5	3,8	4	19YF / 70 A305	SPGO	GS1810-V0	–	○	
	16	16	4	88 NBR 101	T OF	15125	–		○
54	38,5	5,9	6,3	PTFE GM201 / NBR	OMK-MR	49003793	–		○
	43	4	4,2	PTFE C104 / NBR	OMK-MR	49039871	–		○
	43	4	4,2	PTFE B602 / NBR	OMK-MR	529873	–		○
	43,3	4	4,2	PTFE B602 / NBR	OMK-E	24369298	–		○
	48	4,4	4,7	31BF / 70 A305	SPGC	GS1046-F0	–	○	
	10	25		90 NBR 109	TDUOH	9664	–	○	○
55	12	20	5	88 NBR 101	T OF	15130	–		○
	13	15	4	88 NBR 101	T OF	15139 40421304	IP SP		● ●
	16	10	3	88 NBR 101	T OF	15129 40421302	IP SP		● ●
	18	10	2	88 NBR 101	T OF	15137 40421303	IP SP		● ●
	25	12	2,9	94 U811	CPI	FC0068-C0	–	○	
	30	12	13	90 NBR 109	N 1	16485 40421432	IP SP		● ●
	30	15	16	90 NBR 109	N 1	16484	–		○
	35	10	11	94 AU 925	AUN 1	14152 40421170	IP SP		● ●
	35	10	11	90 NBR 109	N 1	11664 40421079	IP SP		● ●
	35	10	11	90 NBR 109	N 100	16563 40421452	IP SP		● ●

D [mm]	d [mm]	H [mm]	L [mm]	Material	Design	Part No.	PU ¹⁾	US	EU
55	35	12	13	94 AU 925	AUN 100	14318 40421195	IP SP		● ●
	35	12	13	90 NBR 109	N 100	17649	-		○
	35	12	13	94 AU 925	NA 300	401253	-		○
	36	10	3,2	88 NBR 101	T OF	15146 40421305	IP SP		● ●
	36	10	11	90 NBR 109	N 1	16566 40421453	IP SP		● ●
	38	10	11	94 AU 925	AUN 100	14323 40421199	- SP	○	● ●
	39	18,4	18,4	80 NBR B281	L 43	529744	-		○
	39	20,5	20,5	80 NBR B281	L 43	24251802	IP		●
	39,5	6	6,3	95 AU V142	OMK-PU	24361251	-		○
	39,5	6	6,3	98 AU 928	SK 300	417294	IP	○	●
	40	7,2	7,5	PTFE GM201	OMK-S	24096097	-		○
	40	9	10	94 U801	ODI	FU0689-H0	-	○	
	40	9,3	9,5	95 AU V142	T 18	24245854	IP		●
	40	9,3	10	95 AU V142	T 18	24245879	IP		●
	40	9,5	10,5	90 NBR 109	N 100	18063 40421576	IP SP		● ●
	40	10	3	70 NBR A103	CPH	CC0067-C0	-	○	
	40	10	11	94 AU 925	AUN 100	14358 40421215	IP SP		● ●
	40	10	11	90 NBR 109	N 1	16630 40421465	IP SP		● ●
	40	10	11	80 NBR 878	NA 250	18446	IP		●
	40	10	11	80 NBR 878	NA 400	4565	IP	○	●
	40	10	11	94 U801	ODI	FU0690-H0	-	○	
	40	11	11,5	BH-NBR B3B246	EK	24070157	-		○
	40	11	11,5	BHFKM B3K674	EKV	24148049	-		○
	42	6,5	7,5	90 NBR 109	N 1	16649 40421466	IP SP		● ●
	44	4	4,2	PTFE GM201 / NBR	OMK-MR	24131857	IP		●
	44	4	4,2	PTFE B602 / NBR	OMK-MR	24178468	IP		●
	44	4	4,2	PTFE GM201 / FKM	OMK-MR	24236605	-		○
	44	4	4,2	PTFE B602 / FKM	OMK-MR	24260918	-		○
	44	4	4,2	PTFE C104 / NBR	OMK-MR	49013986	-		○
	44	4	4,2	95 AU V142	OMK-PU	24341026	-		○
	44	6	7	90 NBR 109	N 1	16661 40421469	IP SP		● ●
	44,3	4	4,2	PTFE B602 / NBR	OMK-E	24275936	IP		●
	44,3	4	4,2	PTFE GM201 / NBR	OMK-E	24276257	-		○
	44,3	4	4,2	PTFE B602 / FKM	OMK-E	24334506	-		○
	45	4,3	4,5	19YF / 80 A980	SPG	GS0335-V0	-	○	
	45	6	7	94 U801	OSI	FU0692-L0	-	○	
	45	6	7	A505	OUHR	CU2697-Q1	-	○	
	45	8	9	94 U801	ODI	FU0693-H0	-	○	
	45	10	11	94 AU 925	AUN 100	14359 40421216	- SP	○	● ●
	46,5	3,8	4	19YF / 70 A305	SPGO	GS1811-V0	-	○	
	45,6	6,6	7,1	PTFE F56110	FOA	422322	IP		●
	47,8	3,8	4	PTFE 177023	TFMA	96882	IP		●
49	4,4	4,7	31BF / 70 A305	SPGC	GS1047-F0	-	○		
56	25	12	2,9	94 U812	CPI	FC0070-C0	-	○	
	35	10	11	90 NBR 109	N 1	16559	-		○

D [mm]	d [mm]	H [mm]	L [mm]	Material	Design	Part No.	PU ¹⁾	US	EU	
56	40	8	9	90 NBR 109	N 1	16611 40421459	IP SP		● ●	
	40	10	11	94 AU 925	AUN 1	14177 40421175	IP SP		● ●	
	40	10	11	90 NBR 109	N 1	16621 40421462	IP SP		● ●	
	40	10	11	90 NBR 109	N 100	17662 40421530	IP SP		● ●	
	40	10	11	94 U801	ODI	FU0716-H0	-	○		
	40	12	13	94 U801	ODI	FU0717-H0	-	○		
	41	7,2	10	PTFE GM201	OMK-S	24096099	-		○	
	41	9	10	94 U801	ODI	FU0718-H0	-	○		
	41	10	11	94 U801	ODI	FU0719-H0	-	○		
	41	11	11,5	BH-NBR B3B246	EK	24070158	-		○	
	41	11	11,5	BHFKM B3K674	EKV	24148050	-		○	
	45	4	4,2	PTFE GM201 / NBR	OMK-MR	24131858	-		○	
	45	4	4,2	PTFE B602 / NBR	OMK-MR	24178469	IP		●	
	45	4	4,2	PTFE B602 / FKM	OMK-MR	24348359	-		○	
	45,3	4	4,2	PTFE B602 / NBR	OMK-E	24276014	-		○	
	45,3	4	4,2	PTFE GM201 / NBR	OMK-E	24276358	-		○	
	45,3	4	4,2	PTFE B602 / FKM	OMK-E	24345115	-		○	
	46	4,3	4,5	19YF / 80 A980	SPG	GS0336-V0	-	○		
	46	6	7	94 U801	OSI	FU0720-H0	-	○		
	46	8	9	94 U801	ODI	FU0721-H0	-	○		
	46,6	6,6	7,1	PTFE F56110	FOA	422323	IP		●	
	47,5	3,8	4	19YF / 70 A305	SPGO	GS1812-V0	-	○		
	50	4,4	4,7	31BF / 70 A305	SPGC	GS1049-F0	-	○		
	50	8	9	90 NBR 109	N 1	11666 40421080	IP SP		● ●	
	57	45	6	7	90 NBR 109	N 1	16679 40421474	IP SP		● ●
	58	32	14	4	88 NBR 101	T OF	15161	-		○
38		10	11	94 AU 925	AUN 1	14165 40421171	IP SP		● ●	
38		10	11	90 NBR 109	N 1	16587	IP		●	
38		12	13	90 NBR 109	N 100	17789	-		○	
45		6,5	7,5	90 NBR 109	N 1	16677 40421473	IP SP		● ●	
45		10	11	90 NBR 109	N 100	17858 40421553	IP SP		● ●	
47		4	4,2	PTFE B602 / NBR	OMK-MR	24329145	-		○	
48		7	7,5	31BF / 70 A305	SPGC	GS1045-F0	-	○		
59	17	20	4	88 NBR 101	T OF	15163	-		○	
60	0	16	4	88 NBR 101	T OF	15183 40421307	IP SP		● ●	
	16	11	3	88 NBR 101	T OF	15171	-		○	
	24	12	3	88 NBR 101	T OF	15180	-		○	
	25	20	3	88 NBR 101	T OF	15166	-		○	
	30	12	2,9	94 U813	CPI	FC0077-C0	-	○		
	30	12	3	90 NBR A505	CPH	CC0077-C0	-	○		
	30	13	3	88 NBR 101	T OF	15185	-		○	
	35	12	3	88 NBR 101	T MF	15168 40421306	IP SP		● ●	
	35	12	3,5	88 NBR 101	T MF	15182	-		○	
	35	12	13	94 AU 925	AUN 1	14154	-		○	

D [mm]	d [mm]	H [mm]	L [mm]	Material	Design	Part No.	PU ¹⁾	US	EU
60	35	12	13	90 NBR 109	N 1	16550 40421449	IP SP		● ●
	38	12	13	90 NBR 109	N 1	16593	-		○
	40	10	11	94 AU 925	AUN 1	14174 40421173	IP SP		● ●
	40	10	11	90 NBR 109	N 1	16610 40421458	IP SP		● ●
	40	12	13	90 NBR 109	N 100	17698 40421536	IP SP		● ●
	40	12	13	80 NBR 878	NA 250	18450	-		○
	40	12	13	94 AU 925	NA 300	21712 40421672	IP SP		● ●
	40	12	13	80 NBR 878	NA 400	30008	-		○
	40	13	14	94 AU 925	AUN 100	14169 40421172	IP SP		● ●
	40,5	8	2,5	70 NBR A103	CPH	CC0074-CO	-	○	
	40,5	8	2,5	88 NBR 101	T OF	15164	-		○
	42	8	2,5	88 NBR 101	T OF	13392	-		○
	44	18,4	18,4	80 NBR B281	L 43	24251781	IP		●
	44	19	20,5	93 AU V167	T 42	24367984	-		○
	44	20,5	20,5	80 NBR B281	L 43	24251787	IP		●
	44,5	6	6,3	98 AU 928	SK 300	417295 1449485	IP -	●	●
	44,9	5,9	6,3	PTFE GM201 / NBR	OMK-E	24269473	-		○
	44,9	5,9	6,3	PTFE B602 / NBR	OMK-E	24275938	IP		●
	44,9	5,9	6,3	PTFE B602 / FKM	OMK-E	24290446	-		○
	45	7,2	7,5	PTFE GM201	OMK-S	24096100	-		○
	45	9	10	94 U801	ODI	FU0740-H0	-	○	
	45	9,3	9,5	95 AU V142	T 18	24245855	IP		●
	45	9,3	10	95 AU V142	T 18	24245880	IP		●
	45	10	11	94 AU 925	AUN 100	14360 40421217	IP SP	○	● ●
	45	10	11	90 NBR 109	N 100	35153 40421745	IP SP		● ●
	45	10	11	80 NBR 878	NA 250	18449	IP		●
	45	10	11	94 AU 925	NA 300	21713 40421673	IP SP		● ●
	45	10	11	94 U801	ODI	FU0741-H0	-	○	
	45	11	11,5	BHNBR B3B246	EK	24070159	IP		●
	45	11	11,5	BHFKM B3K674	EKV	24139297	-		○
	46	8,5	9	19YF / 80 NBR A980 / PA 12NM	SPGW	GS0528-V5	-	○	
	47,8	7,3	7,5	PTFE 177023	TFMA	97024	IP		●
	48	6	7	90 NBR 109	N 1	16707 40421476	IP SP		● ●
	48	9	10	94 AU 925	AUN 1	13789 40421153	IP SP		● ●
	48	28,9	28,9	80 NBR 878	SK 320	10647	IP		●
	49	3,95	4,2	PA 4112	HDP 330	49036073	IP		●
	49	4	4,2	PTFE GM201 / NBR	OMK-MR	24131859	IP		●
	49	4	4,2	PTFE B602 / NBR	OMK-MR	24178470	IP		●
	49	4	4,2	PTFE GM201 / FKM	OMK-MR	24213552	-		○
	49	4	4,2	PTFE B602 / FKM	OMK-MR	24288831	-		○
	49	4	4,2	PTFE GM201 / NBR	OMK-MR	24290302	-		○
	49	4	4,2	PTFE C104 / NBR	OMK-MR	49020100	-		○

D [mm]	d [mm]	H [mm]	L [mm]	Material	Design	Part No.	PU ¹⁾	US	EU
	49	4	4,2	95 AU V142	OMK-PU	24341027	-		○
	49	4	4,2	98 AU 928	SK 300	416490	IP	○	●
	49,3	4	4,2	PTFE GM201 / NBR	OMK-E	49032910	-		○
	50	4,3	4,5	19YF / 80 A980	SPG	GS0337-V0	-	○	
	50	6	7	94 U801	OSI	FU0742-L0	-	○	
	50	6	7	A505	OUHR	CU2696-Q2	-	○	
	50	6	7	A567	OUHR	CU2696-Q3	-	○	
	50	6	7	94 U641	OUIS	FU0742-P0	-	○	
60	50	6	7	94 U801	OUIS	FU0742-P1	-	○	
	50	7	7,5	31BF / 70 A305	SPGC	GS1048-F0	-	○	
	50	8	9	94 U801	ODI	FU0743-H0	-	○	
	50	10	11	94 AU 925	AUN 100	14361 40421218	- SP	○	● ●
	50	10	11	90 NBR 109	N 1	16740 40421480	IP SP		● ● ●
	50	10	11	94 AU 925	NA 300	21718 40421674	IP SP		● ●
	50,6	6,6	7,1	PTFE F56110	FOA	366339	IP		●
	51,5	3,8	4	19YF / 70 A305	SPGO	GS1813-V0	-	○	
61	45	12	13	94 U801	ODI	FU2163-H0	-	○	
	40	12	3	88 NBR 101	T OF	15197	-		○
	41	30		90 NBR 109	TDUOH	9679	-		○
	42	10	11	90 NBR 109	N 1	16652 40421467	IP SP		● ●
	42	12	13	90 NBR 109	N 100	17935 40421563	IP SP		● ● ●
62	50	6	7	90 NBR 109	N 1	16735 40421479	- SP	○	● ●
	50	9	10	94 AU 925	AUN 1	14211 40421180	IP SP		● ● ●
	51	4	4,2	PTFE B602 / NBR	OMK-MR	24328992	-		○
	52	6	7	90 NBR 109	N 1	16763 40421482	IP SP		● ●
	52	7	7,5	31BF / 70 A305	SPGC	GS1050-F0	-	○	
	52	12	13	94 AU 925	AUN 100	12296 40421111	IP SP		● ●
	12	25		90 NBR 109	TDUOH	63684 6368446	IP -	●	●
	35	12	2,9	94 U814	CPI	FC0090-C0	-	○	
	43	10	11	90 NBR 109	N 1	16657	-		○
	43	12	13	94 AU 925	NA 300	21719	-		○
	43	12	13	80 NBR 878	NA 400	25351	-		○
	45	10	11	94 AU 925	AUN 1	14192 40421178	IP SP		● ●
	45	10	11	90 NBR 109	N 1	16673 40421471	IP SP		● ● ●
63	45	12	13	80 NBR 878	NA 250	18451	IP		●
	45	12	13	94 AU 925	NA 300	401256	IP		●
	47	10	11	94 U801	ODI	FU0779-H0	-	○	
	47	12	13	94 U801	ODI	FU0780-H0	-	○	
	47	18,4	18,4	80 NBR B281	L 43	24251793	IP		●
	47	19,4	19,4	80 NBR B281	L 43	24251798	IP		●
	47	20,5	20,5	80 NBR B281	L 43	24251803	IP		●
	47,5	5,9	6,3	PTFE B602 / FKM	OMK-E	49062063	-		○
	47,5	5,9	6,3	PTFE B602 / NBR	OMK-E	49062064	-		○
	47,5	5,9	6,3	PTFE GM201 / NBR	OMK-E	49062065	-		○

D [mm]	d [mm]	H [mm]	L [mm]	Material	Design	Part No.	PU ¹⁾	US	EU
	47,5	6	6,3	95 AU V142	OMK-PU	24341046	-		○
	47,5	6	6,3	98 AU 928	SK 300	416491	IP		●
	47,5	6,05	6,3	PA 4112	HDP 330	49056136	IP		●
	47,9	5,9	6,3	PTFE B602 / FKM	OMK-E	24260919	-		○
	47,9	5,9	6,3	PTFE GM201 / NBR	OMK-E	24274574	-		○
	47,9	5,9	6,3	PTFE B602 / NBR	OMK-E	24275917	IP		●
	47,9	5,9	6,3	PTFE GM201 / NBR	OMK-E	24276239	-		○
	48	7,2	10	PTFE GM201	OMK-S	24096101	-		○
	48	7,3	7,5	19YF / 80 A980	SPG	GS0338-V0	-	○	
	48	9	10	94 U801	ODI	FU0781-H0	-	○	
	48	9,3	9,5	95 AU V142	T 18	24245856	IP		●
	48	9,3	10	95 AU V142	T 18	24245881	IP		●
	48	10	11	80 NBR 878	NA 400	25330	IP		●
	48	10	11	94 U801	ODI	FU0782-H0	-	○	
	48	12	12,5	BHNBR B3B246	EK	24076835	-		○
	48	12	13	94 AU 925	NA 300	21727 40421675	IP SP		● ●
	48	12,5	13	BHNBR B3B246	EK	24070160	IP		●
	48	12,5	13	BHFKM B3K674	EKV	24139361	IP		●
	49	6,3	6,5	19YF / 70 A305	SPGO	GS1814-V0	-	○	
	50	6	7	94 AU 925	AUN 1	13799 40421154	IP SP		● ●
	50	14	14,5	80 NBR 878	SK 520	371339	-		○
	50,8	7,3	7,5	PTFE 177023	TFMA	132794	-		○
63	51	6	7	90 NBR 109	N 1	16755 40421481	IP SP		● ●
	51	9	10	PTFE B602	L 27	24361314	-		○
	51	14	14,5	80 NBR 878	SK 520	316673	IP		●
	51	28,9	28,9	80 NBR 878	SK 320	10651	IP		●
	52	3,95	4,2	PA 4112	HDP 330	49312922	-		○
	52	4	4,2	PTFE GM201 / NBR	OMK-MR	24123140	IP		●
	52	4	4,2	PTFE B602 / NBR	OMK-MR	24178471	IP		●
	52	4	4,2	PTFE GM201 / FKM	OMK-MR	24194079	-		○
	52	4	4,2	PTFE B602 / FKM	OMK-MR	24263382	IP		●
	52	4	4,2	95 AU V142	OMK-PU	24341049	-		○
	52	4	4,2	98 AU 928	SK 300	416494	IP	○	●
	52,3	4	4,2	PTFE GM201 / FKM	OMK-E	24243923	-		○
	53	6	7	94 U801	OSI	FU0784-L0	-	○	
	53	6	7	A505	OUHR	CU2685-Q0	-	○	
	53	6	7	A567	OUHR	CU2685-Q4	-	○	
	53	6	7	94 U641	OUIS	FU0784-P0	-	○	
	53	6	7	94 U801	OUIS	FU0784-P1	-	○	
	53	7	7,5	80 NBR 878	NA 150	84522 40421761	IP SP		● ●
	53	7	7,5	31BF / 70 A305	SPGC	GS1051-F0	-	○	
	53	8	9	94 U801	ODI	FU0785-H0	-	○	
	53	11,6	12,5	95 AU V142	T 19	24237695	IP		●
	53	12	13	94 AU 925	NA 300	21730 40421676	IP SP		● ●
	53,6	6,6	7,1	PTFE F56110	FOA	366340	IP		●
64	40	12	13	90 NBR 109	N 1	16617	-		○
65	0	18	4	88 NBR 101	T OF	15223	-		○
	12	25		90 NBR 109	TDUOH	9688	IP		●

D [mm]	d [mm]	H [mm]	L [mm]	Material	Design	Part No.	PU ¹⁾	US	EU
65	16	20	3	88 NBR 101	T OF	15207	-		○
	25	12	3,5	88 NBR 101	T OF	15219	-		○
	34,5	13	3,5	80 NBR 104	CPH	CC0096-C0	-	○	
	35	12	2,9	94 U815	CPI	FC0095-C0	-	○	
	35,2	13	4	88 NBR 101	T OF	15212	-		○
	40	12	13	94 AU 925	AUN 1	14176 40421174	IP SP		● ●
	40	12	13	90 NBR 109	N 1	16608	-		○
	42	9	2,5	88 NBR 101	T MF	15210 40421308	IP SP		● ●
	45	10	11	94 AU 925	AUN 1	14188 40421177	IP SP		● ●
	45	10	11	90 NBR 109	N 1	16674 40421472	IP SP		● ●
	45	12	13	94 AU 925	AUN 100	35601 40421746	IP SP		● ●
	45	12	13	90 NBR 109	N 100	16693 40421475	IP SP		● ●
	45	12	13	80 NBR 878	NA 250	18453	-		○
	48	10	11	90 NBR 109	N 1	16715	-		○
	49	8	9	90 NBR 109	N 1	16722	-		○
	49	20,5	20,5	80 NBR B281	L 43	24289999	IP		●
	49,5	6	6,3	98 AU 928	SK 300	505020 1617144	IP -	●	●
	49,9	5,9	6,3	PTFE B602 / NBR	OMK-E	24275940	-		○
	49,9	5,9	6,3	PTFE GM201 / NBR	OMK-E	24276261	-		○
	49,9	5,9	6,3	PTFE B602 / FKM	OMK-E	24345116	-		○
	50	7,2	10	PTFE GM201	OMK-S	24170874	-		○
	50	7,3	7,5	19YF / 80 A980	SPG	GS0339-V0	-	○	
	50	9	10	94 U801	ODI	FU0804-H0	-	○	
	50	9,3	9,5	95 AU V142	T 18	24245857	IP		●
	50	9,3	10	95 AU V142	T 18	24245882	IP		●
	50	10	11	94 AU 925	AUN 100	14362 40421219	IP SP		● ●
	50	10	11	80 NBR 878	NA 250	18452	-		○
	50	10	11	94 AU 925	NA 300	401260	-		○
	50	10	11	94 U801	ODI	FU0805-H0	-	○	
	50	10,5	11	19YF / 80 NBR A980 / PA 12NM	SPGW	GS3013-V5	-	○	
	50	10,5	11	19YF / 85 HNBR G928 / PA 12NM	SPGW	GS3013-V6	-	○	
	50	12	13	90 NBR 109	N 100	18000 40421570	IP SP		● ●
	50	12,5	13	BI-NBR B3B246	EK	24138932	-		○
	50	18,4	18,4	80 NBR B281	L 43	529745	-		○
	51	6,3	6,5	19YF / 70 A305	SPGO	GS1815-V0	-	○	
	52,8	7,3	7,5	PTFE 177023	TFMA	97025	-		○
	53	6	7	94 AU 925	AUN 1	12297 40421112	IP SP		● ●
	53	10	11	90 NBR 109	N 1	16768	-		○
	54	4	4,2	PTFE GM201 / NBR	OMK-MR	24104068	IP		●
	54	4	4,2	PTFE B602 / NBR	OMK-MR	24191950	IP		●
	54	4	4,2	PTFE GM201 / FKM	OMK-MR	24236604	-		○
	54	4	4,2	PTFE B602 / FKM	OMK-MR	24348360	-		○
54	4	4,2	95 AU V142	OMK-PU	24341028	-		○	

D [mm]	d [mm]	H [mm]	L [mm]	Material	Design	Part No.	PU ¹⁾	US	EU
65	55	5	6	90 NBR 109	N 1	16787 40421486	IP SP		● ●
	55	6	7	94 U801	OSI	FU0807-L0	-	○	
	55	6	7	A505	OUHR	CU2930-Q2	-	○	
	55	6	7	A567	OUHR	CU2930-Q3	-	○	
	55	6	7	94 U641	OUIS	FU0807-P0	-	○	
	55	6	7	94 U801	OUIS	FU0807-P1	-	○	
	55	7	7,5	31BF / 70 A305	SPGC	GS1052-F0	-	○	
	55	8	9	94 U801	ODI	FU0808-H0	-	○	
	55,6	6,6	7,1	PTFE F56110	FOA	371445	IP		●
66	16	16	3	88 NBR 101	T OF	15229	-		○
	50	12	13	94 U801	ODI	FU2164-H0	-	○	
	50,9	6,3	6,3	PTFE B602 / NBR	OMK-E	49000481	-		○
	56	6	7	94 U801	OSI	FU0825-L0	-	○	
	56	7	7,5	31BF / 70 A305	SPGC	GS1053-F0	-	○	
67	38	12	2,9	94 U816	CPI	FC0102-C1	-	○	
68	35	10	3	88 NBR 101	T OF	15237	-		○
	48	10	11	90 NBR 109	N 1	16709	-		○
	48	12	13	90 NBR 109	N 100	17625	-		○
	52,9	5,9	6,3	PTFE GM201 / FKM	OMK-E	533174	-		○
	55	6,5	7,5	90 NBR 109	N 1	16783 40421484	IP SP		● ●
	57	4	4,2	PTFE B602 / NBR	OMK-MR	24328993	-		○
	58	7	7,5	31BF / 70 A305	SPGC	GS1054-F0	-	○	
	60	8	9	94 AU 925	AUN 1	12157	-		○
69	60	8	9	90 NBR 109	N 1	16820 40421489	IP SP		● ●
	53	12	13	94 U801	ODI	FU0836-H0	-	○	
	54	7,3	7,5	19YF / 80 A980	SPG	GS0340-V0	-	○	
70	12	13	3	88 NBR 101	T OF	15248	-		○
	12	30		90 NBR 109	TDUOH	9707	IP		●
	20	13	3,5	88 NBR 101	T MF	15257 40421312	IP SP		● ●
	20	13	3,5	88 NBR 101	T OF	15252	-		○
	20	15	3	88 NBR 101	T OF	15243	-		○
	22	9	2	88 NBR 101	T OF	15249 40421310	IP SP		● ●
	24	15	3	88 NBR 101	T MF	15247	-		○
	35	10	3	88 NBR 101	T OF	15253	-		○
	38	12	2,9	94 U817	CPI	FC0106-C0	-	○	
	38	12	3	90 NBR A505	CPH	CC0106-C2	-	○	
	40	12	3	88 NBR 101	T MF	15254 40421311	IP SP		● ●
	40	13	2,5	88 NBR 101	T OF	15245 40421309	IP SP		● ●
	40	15	16	90 NBR 109	N 1	16609	-		○
	44	12	3,5	88 NBR 101	T OF	15241	-		○
	45	12	13	94 AU 925	AUN 1	14191	-		○
	45	12	13	90 NBR 109	N 1	16676	-		○
	50	8	2,5	88 NBR 101	T OF	15244	-		○
	50	10	11	94 AU 925	AUN 1	14207 40421179	IP SP		● ●
	50	10	11	90 NBR 109	N 1	16728 40421477	- SP	○	● ●

D [mm]	d [mm]	H [mm]	L [mm]	Material	Design	Part No.	PU ¹⁾	US	EU
70	50	12	13	94 AU 925	AUN 100	14267 40421186	IP SP		● ●
	50	12	13	90 NBR 109	N 100	17650 40421529	IP SP		● ●
	50	12	13	80 NBR 878	NA 250	18457	–	○	○
	50	12	13	94 AU 925	NA 300	21733 40421677	IP SP		● ●
	50	12	13	80 NBR 878	NA 400	4566	IP		●
	50	12	13	94 U801	ODI	FU0842-H0	–	○	
	50	12,2	12,5	95 AU V142	T 18	24245858	IP		●
	50	12,2	13	95 AU V142	T 18	24245883	IP		●
	50	14,6	15,2	BHNBR B4B246	EK	24070161	IP		●
	50	14,6	15,2	BHFKM B4K674	EKV	24139314	–		○
	50	18	19	94 AU 925	AUN 1	14212 40421181	IP SP		● ●
	50	22,4	22,4	80 NBR B281	L 43	24251788	IP		●
	52	9	10	94 AU 925	AUN 1	14250	–		○
	53	13,4	14	PTFE B602	L 27	24375726	IP		●
	54	20,5	20,5	80 NBR B281	L 43	24251782	IP		●
	54,5	5,9	6,3	PTFE GM201 / NBR	OMK-MR	24131887	–		○
	54,5	5,9	6,3	PTFE B602 / NBR	OMK-MR	24213778	IP		●
	54,5	5,9	6,3	PTFE GM201 / NBR	OMK-MR	24258071	–		○
	54,5	5,9	6,3	PTFE B602 / FKM	OMK-MR	24332341	–		○
	54,5	5,9	6,3	PTFE C104 / NBR	OMK-MR	49030513	–		○
	54,5	6	6,3	98 AU 928	SK 300	417299	IP	●	●
	54,5	6,05	6,3	PA 4112	HDP 330	49306404	IP		●
	54,5	6,3	6,3	PTFE GM201 / FKM	OMK-MR	533177	–		○
	54,9	5,9	6,3	PTFE B602 / NBR	OMK-E	24276004	IP		●
	54,9	5,9	6,3	PTFE GM201 / NBR	OMK-E	24276348	–		○
	54,9	5,9	6,3	PTFE B602 / FKM	OMK-E	24345117	–		○
	55	7,2	7,5	PTFE GM201	OMK-S	24096102	–		○
	55	7,3	7,5	19YF / 80 A980	SPG	GS0341-V0	–	○	
	55	7,5	8,5	90 NBR 109	N 1	16784 40421485	IP SP		● ●
	55	9	10	94 U801	ODI	FU0844-H0	–	○	
	55	9,3	9,5	95 AU V142	T 18	24298857	IP		●
	55	10	11	94 U801	ODI	FU0845-H0	–	○	
	55	10,5	11	19YF / 80 NBR A980 / PA 12NM	SPGW	GS0607-V5	–	○	
	55	10,5	11	19YF / 85 HNBR G928 / PA 12NM	SPGW	GS0607-V7	–	○	
	55	12	13	94 AU 925	AUN 100	14363 40421220	– SP	○	● ●
	55	12	13	80 NBR 878	NA 250	18456	IP		●
	55	12	13	94 AU 925	NA 300	21735 40421678	IP SP		● ●
	56	6,3	6,5	19YF / 70 A305	SPGO	GS1816-V0	–	○	
	57,8	7,3	7,5	PTFE 177023	TFMA	97026	–	○	○
	58	6	7	90 NBR 109	N 1	16806 40421487	IP SP		● ●
	58	8,5	9,5	80 NBR 878	NA 150	84523 40421762	IP SP		● ●
	58	28,9	28,9	80 NBR 878	SK 320	10660	IP	○	●
59	3,95	4,2	PA 4112	HDP 330	49036104	IP		●	
59	4	4,2	PTFE GM201 / NBR	OMK-MR	24131860	IP		●	

D [mm]	d [mm]	H [mm]	L [mm]	Material	Design	Part No.	PU ¹⁾	US	EU
	59	4	4,2	PTFE GM201 / FKM	OMK-MR	24186190	-		○
	59	4	4,2	PTFE B602 / NBR	OMK-MR	24213776	IP		●
	59	4	4,2	PTFE B602 / FKM	OMK-MR	24348379	IP		●
	59	4	4,2	95 AU V142	OMK-PU	24341029	-		○
	59	4	4,2	98 AU 928	SK 300	416495	IP		●
	59	4,2	4,2	PTFE C104 / NBR	OMK-MR	49021488	IP		●
	60	6	7	94 U801	OSI	FU0846-L0	-	○	
	60	6	7	A567	OUHR	CU2634-Q2	-	○	
70	60	6	7	94 U641	OUIS	FU0846-P0	-	○	
	60	6	7	94 U801	OUIS	FU0846-P1	-	○	
	60	7	7,5	31BF / 70 A305	SPGC	GS1055-F0	-	○	
	60	8	9	94 U801	ODI	FU0847-H0	-	○	
	60	11,65	12,5	95 AU V142	T 19	24299663	IP		●
	60	12	13	94 AU 925	AUN 100	14411 40421242	IP SP		● ●
	60	12	13	94 AU 925	NA 300	21737 40421679	IP SP		● ●
	60,6	6,6	7,1	PTFE F56110	FOA	366341	IP		●
	40	12	2,9	94 U818	CPI	FC0114-C0	-	○	
	51	12	13	94 U801	ODI	FU0872-H0	-	○	
	55	10	11	94 U801	ODI	FU0873-H0	-	○	
	55	12	13	94 U801	ODI	FU0874-H0	-	○	
71	56	7,3	7,5	19YF / 80 A980	SPG	GS0342-V0	-	○	
	56	9	10	94 U801	ODI	FU0875-H0	-	○	
	56	10	11	94 U801	ODI	FU0876-H0	-	○	
	57	6,3	6,5	19YF / 70 A305	SPGO	GS1817-V0	-	○	
	61	6	7	94 U801	OSI	FU0877-L0	-	○	
	61	8	9	94 U801	ODI	FU0878-H0	-	○	
	26	13	3	88 NBR 101	T MF	15269 40421313	IP SP		● ●
	50	12	13	90 NBR 109	N 1	16730 40421478	IP SP		● ●
	52	12	13	90 NBR 109	N 100	17755 40421541	IP SP		● ●
72	56,5	5,9	6,3	PTFE B602 / NBR	OMK-MR	24261989	-		○
	56,5	5,9	6,3	PTFE GM201 / FKM	OMK-MR	49001731	-		○
	60	6	7	94 AU 925	AUN 1	14448	-		○
	61	4	4,2	PTFE B602 / NBR	OMK-MR	24298763	-		○
	62	7	7,5	31BF / 70 A305	SPGC	GS1056-F0	-	○	
	61	6	7	90 NBR 109	N 1	16852	-		○
73	62	4	4,2	PTFE B602 / NBR	OMK-MR	24333839	-		○
	63	6	7	94 U801	OSI	FU0889-L0	-	○	
	63	7	7,5	31BF / 70 A305	SPGC	GS1057-F0	-	○	
	50	12	13	90 NBR 109	N 1	16734	-		○
74	60	7	8	90 NBR 109	N 1	16828 40421490	IP SP		● ●
	63	4	4,2	PTFE B602 / NBR	OMK-MR	24328994	-		○
	12	30		90 NBR 109	TDUOH	11618	IP	○	●
	25	15	3	88 NBR 101	T OF	15276 40421314	IP SP		● ●
75	38	12	3	80 NBR 104	CPH	CC0117-C1	-	○	
	40	12	2,9	94 U819	CPI	FC0117-C0	-	○	
	50	10	2,5	88 NBR 101	T MF	15277 40421315	IP SP		● ●

D [mm]	d [mm]	H [mm]	L [mm]	Material	Design	Part No.	PU ¹⁾	US	EU
	50	12,5	13,5	94 AU 925	AUN 1	14210	-		○
	50	15	16	90 NBR 109	N 100	17827	-		○
	53	15	4	88 NBR 101	T OF	15282	-		○
	55	10	11	94 AU 925	AUN 1	14227 40421182	IP SP		● ●
	55	10	11	90 NBR 109	N 1	16778 40421483	IP SP		● ●
	55	12	13	94 AU 925	AUN 100	14364 40421221	IP SP		● ●
	55	12	13	90 NBR 109	N 100	17674 40421533	IP SP		● ●
	55	12	13	94 AU 925	NA 300	401254	-		○
	55	12	13	80 NBR 878	NA 400	30009	IP		●
	55	12	13	94 U801	ODI	FU0894-H0	-	○	
	55	12,2	12,5	95 AU V142	T 18	24338114	IP		●
	55	22,4	22,4	80 NBR B281	L 43	24380527	IP		●
	59	20,5	20,5	80 NBR B281	L 43	24379140	IP		●
	59,5	5,9	6,3	PTFE GM201 / NBR	OMK-MR	24213523	IP		●
	59,5	5,9	6,3	PTFE B602 / NBR	OMK-MR	24213782	IP		●
	59,5	5,9	6,3	PTFE B602 / FKM	OMK-MR	24348378	-		○
	59,5	6	6,3	98 AU 928	SK 300	416497 1617146	IP -	●	●
	59,9	5,9	6,3	PTFE B602 / NBR	OMK-E	24275942	IP		●
	59,9	5,9	6,3	PTFE GM201 / NBR	OMK-E	24276263	-		○
	59,9	5,9	6,3	PTFE B602 / FKM	OMK-E	24345118	-		○
	59,9	5,9	6,3	PTFE GM201 / FKM	OMK-E	24355414	-		○
75	60	7,3	7,5	19YF / 80 A980	SPG	GS0343-V0	-	○	
	60	9	10	94 U801	ODI	FU0895-H0	-	○	
	60	10	11	94 U801	ODI	FU0896-H0	-	○	
	60	10,5	11	19YF / 80 NBR A980 / PA 12NM	SPGW	GS0995-V5	-	○	
	60	10,5	11	19YF / 85 HNBR G928 / PA 12NM	SPGW	GS0995-V6	-	○	
	60	12	13	94 AU 925	AUN 100	14365 40421222	IP SP		● ●
	60	12	13	94 AU 925	NA 300	401262	-		○
	61	6,3	6,5	19YF / 70 A305	SPGO	GS1818-V0	-	○	
	62	7,5	8,5	A505	OUHR	CU2943-Q2	-	○	
	62	7,5	8,5	A567	OUHR	CU2943-Q3	-	○	
	62,8	7,3	7,5	PTFE 177023	TFMA	97027	-		○
	63	18	18,5	80 NBR 878	SK 520	121438	IP		●
	64	4	4,2	PTFE GM201 / NBR	OMK-MR	24145486	-		○
	64	4	4,2	PTFE B602 / NBR	OMK-MR	24213780	IP		●
	64	4	4,2	PTFE GM201 / FKM	OMK-MR	24236603	-		○
	64	4	4,2	PTFE B602 / FKM	OMK-MR	24348361	-		○
	64,3	4	4,2	PTFE B602 / NBR	OMK-E	24378829	-		○
	65	6	7	94 U801	OSI	FU0897-L0	-	○	
	65	6	7	94 U641	OUIS	FU0897-P0	-	○	
	65	6	7	94 U801	OUIS	FU0897-P1	-	○	
	65	7	7,5	31BF / 70 A305	SPGC	GS1058-F0	-	○	
	65	8	9	94 U801	ODI	FU0898-H0	-	○	
	65	12	13	94 AU 925	AUN 100	14407 40421241	IP SP		● ●
	65,6	6,6	7,1	PTFE F56110	FOA	422325	IP		●

D [mm]	d [mm]	H [mm]	L [mm]	Material	Design	Part No.	PU ¹⁾	US	EU
76	20	16	3	88 NBR 101	T OF	15287 40421316	IP SP		● ●
	60	12	13	94 U801	ODI	FU2165-H0	-	○	
	66	10	11	90 NBR 109	N 1	16887	-		○
76,2	61,1	5,9	6,3	PTFE B602 / NBR	OMK-E	24329923	-		○
77	67	6	7	94 U801	OSI	FU0922-L0	-	○	
	67	7	7,5	31BF / 70 A305	SPGC	GS1059-F0	-	○	
78	40	15	4	88 NBR 101	T OF	15291	-		○
	62	8	9	90 NBR 109	N 1	16858	-		○
	67	4	4,2	PTFE B602 / NBR	OMK-MR	24328995	-		○
	68	10	11	90 NBR 109	N 1	16896	-		○
80	0	20	4	88 NBR 101	T OF	15318	-		○
	12	30		90 NBR 109	TDUOH	9733	IP		●
	20	10	2	88 NBR 101	T MF	15312	-		○
	40	15	4	90 NBR A505	CPH	CC0132-C0	-	○	
	40	16	3,8	94 U820	CPI	FC0134-C0	-	○	
	40	16	4	60 NBR A102	CPH	CC0134-C0	-	○	
	40	20	21	90 NBR 109	N 1	16612	-		○
	42	11	2,5	88 NBR 101	T MF	15294	-		○
	42	13	3,5	88 NBR 101	T OF	15310	-		○
	50	10	2,5	88 NBR 101	T OF	15307 40421317	IP SP		● ●
	50	15	16	90 NBR 109	N 1	16727	-		○
	52	8,5	3	88 NBR 101	T OF	15295	-		○
	55	12	3	88 NBR 101	T MF	15296	-		○
	55	12	13	90 NBR 109	N 1	16780	-		○
	55	15	16	90 NBR 109	N 100	17936	-		○
	55	15	16	80 NBR 878	NA 400	25404	-		○
	59	7,7	8,1	PTFE GM201 / NBR	OMK-MR	24131888	IP		●
	59	7,7	8,1	PTFE B602 / NBR	OMK-MR	24213784	IP		●
	59	7,7	8,1	PTFE GM201 / FKM	OMK-MR	24296464	-		○
	59	7,8	8,1	98 AU 928	SK 300	411795	IP		●
	59	10	10,5	98 AU 928	SK 300	417457	IP		●
	60	9,6	10	PTFE GM201	OMK-S	24096103	IP		●
	60	9,6	10	PTFE GM201	OMK-S	24096862	-		○
	60	10	11	94 AU 925	AUN 1	14450 40421246	IP SP		● ●
	60	10	11	90 NBR 109	N 1	16818 40421488	IP SP		● ●
	60	12	13	94 AU 925	AUN 100	34397 40421744	IP SP		● ●
	60	12	13	90 NBR 109	N 100	16850 40421491	IP SP		● ●
	60	12	13	80 NBR 878	NA 250	18466	IP		●
	60	12	13	94 AU 925	NA 300	21740 40421680	IP SP		● ●
	60	12	13	80 NBR 878	NA 400	25383	IP		●
	60	12	13	94 U801	ODI	FU0929-H0	-	○	
	60	12,2	12,5	95 AU V142	T 18	24245859	IP		●
60	12,2	13	95 AU V142	T 18	24245884	IP		●	
60	14,6	15,2	BH-NBR B4B246	EK	24070162	IP		●	
60	18	19	94 AU 925	AUN 1	14454 40421247	IP SP		● ●	

D [mm]	d [mm]	H [mm]	L [mm]	Material	Design	Part No.	PU ¹⁾	US	EU
	60	22,4	22,4	80 NBR B281	L 43	24251794	IP		●
	62	22,5	22,5	80 NBR B281	L 43	24251799	IP		●
	63	13,4	14	PTFE B602	L 27	24361315	IP		●
	64	8	9	90 NBR 109	N 1	16870 40421492	IP SP		● ●
	64	10	11	94 U801	ODI	FU0931-H0	-	○	
	64	12	13	94 U801	ODI	FU0932-H0	-	○	
	64,5	5,9	6,3	PTFE B602 / FKM	OMK-E	49062066	-		○
	64,5	5,9	6,3	PTFE B602 / NBR	OMK-E	49062067	-		○
	64,5	5,9	6,3	PTFE GM201 / NBR	OMK-E	49062068	-		○
	64,5	5,9	6,3	PTFE GM201 / NBR	OMK-MR	24101263	IP		●
	64,5	5,9	6,3	PTFE GM201 / FKM	OMK-MR	24170831	-		○
	64,5	5,9	6,3	PTFE B602 / NBR	OMK-MR	24178473	IP		●
	64,5	5,9	6,3	PTFE B602 / FKM	OMK-MR	24258031	IP		●
	64,5	5,9	6,3	PTFE C104 / NBR	OMK-MR	49018495	IP		●
	64,5	6	6,3	PA 4112	HDP 330	49036019	IP		●
	64,5	6	6,3	95 AU V142	OMK-PU	24333982	-		○
	64,5	6	6,3	98 AU 928	SK 300	417302	IP	○	●
	64,9	5,9	6,3	PTFE GM201 / NBR	OMK-E	24192313	-		○
	64,9	5,9	6,3	PTFE B602 / FKM	OMK-E	24269662	-		○
	64,9	5,9	6,3	PTFE B602 / NBR	OMK-E	24275984	IP		●
	65	7,3	7,5	19YF / 80 A980	SPG	GS0344-V0	-	○	
	65	7,5	8,5	90 NBR 109	N 1	16882 40421493	IP SP		● ●
	65	9	10	94 U801	ODI	FU0933-H0	-	○	
80	65	9	10	A505	OUHR	CU2666-Q2	-	○	
	65	9	10	A567	OUHR	CU2666-Q3	-	○	
	65	9,3	9,5	95 AU V142	T 18	24290783	IP		●
	65	10	11	80 NBR 878	NA 400	25354	IP		●
	65	10	11	94 U801	ODI	FU0934-H0	-	○	
	65	10,5	11	19YF / 80 NBR A980 / PA 12NM	SPGW	GS0608-V5	-	○	
	65	10,5	11	19YF / 85 HNBR G928 / PA 12NM	SPGW	GS0608-V8	-	○	
	65	11	12	94 AU 925	AUN 1	14240	-		○
	65	11,8	13	80 NBR B246	Seal Set O215	24142953	-		○
	65	12	12,5	BHFKM B3K674	EKV	24248122	-		○
	65	12	13	94 AU 925	AUN 100	14366 40421223	- SP	○	● ●
	65	12	13	80 NBR 878	NA 250	18465	IP		●
	65	12	13	94 AU 925	NA 300	21763 40421681	IP SP	○	● ●
	66	6,3	6,5	19YF / 70 A305	SPGO	GS1819-V0	-	○	
	66	16	16,5	80 NBR 878	SK 520	358382	-		○
	66	32,9	32,9	80 NBR 878	SK 320	10682	IP	○	●
	67,8	7,3	7,5	PTFE 177023	TFMA	94314	IP		●
	68	6	7	94 AU 925	AUN 1	14461 40421248	IP SP		● ●
	68	8,5	9,5	80 NBR 878	NA 150	84524 40421763	IP SP		● ●
	68	12	13	90 NBR 109	N 1	16893 40421494	IP SP		● ●
	70	6	7	94 U801	OSI	FU0936-L0	-	○	
	70	6	7	94 U641	OUIS	FU0936-P0	-	○	

D [mm]	d [mm]	H [mm]	L [mm]	Material	Design	Part No.	PU ¹⁾	US	EU
	70	6	7	94 U801	OUIS	FU0936-P1	-	○	
	70	7	7,5	31BF / 70 A305	SPGC	GS1060-F0	-	○	
	70	8	9	94 U801	ODI	FU0937-H0	-	○	
	70	11,6	12,5	95 AU V142	T 19	24262188	IP		●
	70	12	13	94 AU 925	AUN 100	14431 40421245	IP SP		● ●
80	70	12	13	94 AU 925	NA 300	21765 40421682	IP SP		● ●
	70,6	6,6	7,1	PTFE F56110	FOA	366342	IP		●
	71	6	7	94 U801	OSI	FU2146-L0	-	○	
	71	6	7	A505	OUHR	CU3238-Q1	-	○	
	71	6	7	94 U641	OUIS	FU2146-P0	-	○	
	71	6	7	94 U801	OUIS	FU2146-P1	-	○	
	74	8	9	90 NBR 109	N 1	16932	-		○
81	71	7	7,5	31BF / 70 A305	SPGC	GS1061-F0	-	○	
	42	15,8	4,5	88 NBR 101	T OF	15812	-		○
82	62	10	11	90 NBR 109	N 1	16855	-		○
	65	12	13	80 NBR 878	NA 250	18467	-		○
	70	12	13	90 NBR 109	N 1	16905	-		○
82,6	67,1	5,9	6,3	PTFE B602 / FKM	OMK-MR	24301475	-		○
	63	15	16	94 AU 925	AUN 100	13532	-		○
83	63	15	16	90 NBR 109	N 100	938 40421001	IP SP		● ●
83,1	67,6	5,9	6,3	PTFE GM201 / NBR	OMK-MR	24217905	-		○
	60	12	13	90 NBR 109	N 1	16827	-		○
84	72	6	7	90 NBR 109	N 1	16922 40421497	IP SP		● ●
	12	35		90 NBR 109	TDUOH	9743	-		○
	45	14	2,5	88 NBR 101	T OF	15336	-		○
	45	16	3,8	94 U821	CPI	FC0142-C0	-	○	
	55	15	16	90 NBR 109	N 1	16786	-		○
	60	12	13	90 NBR 109	N 1	16825	-		○
	60	12,5	13,5	94 AU 925	AUN 1	14453	-		○
	60	15	16	90 NBR 109	N 100	17937	-		○
	64	7,7	8,1	PTFE GM201 / NBR	OMK-MR	24213524	-		○
	64	7,7	8,1	PTFE B602 / NBR	OMK-MR	24213786	IP		●
	64	7,7	8,1	PTFE B602 / FKM	OMK-MR	24348842	-		○
	65	10	11	94 AU 925	AUN 1	14251 40421183	IP SP		● ●
85	65	10	11	90 NBR 109	N 1	16880	-		○
	65	12	13	94 AU 925	AUN 100	14297 40421191	IP SP		● ●
	65	12	13	90 NBR 109	N 100	17667 40421532	IP SP		● ●
	65	12	13	94 U801	ODI	FU0974-H0	-	○	
	65	22,4	22,4	80 NBR B281	L 43	49001921	-		○
	65	22,4	22,5	80 NBR B281	L 43	24314803	IP		●
	69,5	5,9	6,3	PTFE B602 / NBR	OMK-MR	24213788	IP		●
	69,5	5,9	6,3	PTFE GM201 / NBR	OMK-MR	24223623	IP		●
	69,5	5,9	6,3	PTFE B602 / FKM	OMK-MR	24348873	-		○
	69,5	5,9	6,3	PTFE C104 / NBR	OMK-MR	49054674	-		○
	69,5	6	6,3	98 AU 928	SK 300	505018 1617149	IP -		● ●
	69,9	5,9	6,3	PTFE B602 / NBR	OMK-E	24275915	-		○

D [mm]	d [mm]	H [mm]	L [mm]	Material	Design	Part No.	PU ¹⁾	US	EU
	69,9	5,9	6,3	PTFE GM201 / NBR	OMK-E	24276237	-		○
	69,9	5,9	6,3	PTFE B602 / FKM	OMK-E	24356574	-		○
	70	7,3	7,5	19YF / 80 A980	SPG	GS0345-V0	-	○	
	70	7,5	8,5	90 NBR 109	N 1	16902 40421496	IP SP		● ●
	70	9	10	94 U801	ODI	FU0977-H0	-	○	
	70	9	10	A505	OUHR	CU0977-Q2	-	○	
	70	9	10	A567	OUHR	CU0977-Q3	-	○	
	70	9,3	9,5	95 AU V142	T 18	24315436	IP		●
	70	10	11	94 U801	ODI	FU0978-H0	-	○	
	70	10,5	11	19YF / 80 NBR A980 / PA 12NM	SPGW	GS0813-V5	-	○	
	70	10,5	11	19YF / 85 HNBR G928 / PA 12NM	SPGW	GS0813-V6	-	○	
85	70	12	13	94 AU 925	AUN 100	14367 40421224	IP SP		● ●
	70	12	13	80 NBR 878	NA 250	18469	IP		●
	70	12	13	94 AU 925	NA 300	81715	-		○
	71	6,3	6,5	19YF / 70 A305	SPGO	GS1820-V0	-	○	
	72,8	7,3	7,5	PTFE 177023	TFMA	97028	-		○
	75	6	7	94 U801	OSI	FU0979-L0	-	○	
	75	6	7	94 U641	OUIS	FU0979-P0	-	○	
	75	6	7	94 U801	OUIS	FU0979-P1	-	○	
	75	7	7,5	31BF / 70 A305	SPGC	GS1062-F0	-	○	
	75	8	9	94 U801	ODI	FU0980-H0	-	○	
	75	12	13	94 AU 925	AUN 100	12185 40421107	IP SP	○	● ●
	75,6	6,6	7,1	PTFE F56110	FOA	422327	-		○
86	78	8	9	90 NBR 109	N 1	16950 40421499	IP SP		● ●
	72,5	5,9	6,3	PTFE B602 / NBR	OMK-MR	24329148	-		○
88	72,9	5,9	6,3	PTFE B602 / NBR	OMK-E	24353965	-		○
	72,9	5,9	6,3	PTFE GM201 / FKM	OMK-E	533175	-		○
88,9	73,8	5,9	6,3	PTFE B602 / NBR	OMK-E	24352792	-		○
	12	35		90 NBR 109	TDUOH	9746 974670	IP -	○	●
	35,1	18	4	88 NBR 101	T OF	15345	-		○
	38	15	4,3	90 NBR A505	CPH	CC0156-C0	-	○	
	45	16	4	60 NBR A102	CPH	CC0157-C0	-	○	
	50	16	3,8	94 U822	CPI	FC0157-C0	-	○	
	50	17	5	80 NBR 104	CPH	CC0159-C0	-	○	
	60	15	16	90 NBR 109	N 1	16831	-		○
	62	18	4	88 NBR 101	T OF	15358 40421319	IP SP		● ●
90	65	12	3	88 NBR 101	T OF	15354 40421318	IP SP		● ●
	65	12	13	90 NBR 109	N 1	16879	-		○
	65	12	13	94 AU 925	NA 300	339345 40421923	IP SP		● ●
	69	7,7	8,1	PTFE GM201 / NBR	OMK-MR	24131889	IP		●
	69	7,7	8,1	PTFE B602 / NBR	OMK-MR	24213790	IP		●
	69	7,7	8,1	PTFE B602 / FKM	OMK-MR	24348872	-		○
	69	7,7	8,1	PTFE GM201 / FKM	OMK-MR	24356942	-		○
	69	7,8	8,1	98 AU 928	SK 300	416501	-		○
	69	10	10,5	98 AU 928	SK 300	416502	IP		●

D [mm]	d [mm]	H [mm]	L [mm]	Material	Design	Part No.	PU ¹⁾	US	EU
90	70	9,6	10	PTFE GM201	OMK-S	24096104	-		○
	70	9,6	10	PTFE GM201	OMK-S	24360341	-		○
	70	10	11	90 NBR 109	N 1	16899 40421495	IP SP		● ●
	70	12	13	94 AU 925	AUN 100	14322 40421198	IP SP		● ●
	70	12	13	90 NBR 109	N 100	17863 40421554	IP SP		● ●
	70	12	13	80 NBR 878	NA 250	18476	-		○
	70	12	13	94 AU 925	NA 300	400522 40421940	IP SP		● ●
	70	12	13	80 NBR 878	NA 400	30011	-		○
	70	12	13	94 U801	ODI	FU1014-H0	-	○	
	70	12,2	12,5	95 AU V142	T 18	24245860	IP	○	●
	70	12,2	13	95 AU V142	T 18	24245885	IP		●
	70	15	16	94 U801	ODI	FU1015-H0	-	○	
	70	18	19	94 AU 925	AUN 1	14465 40421249	IP SP		● ●
	70	20,6	21,2	BHNBR B4B246	EK	24070163	IP		●
	70	20,6	21,2	BHFKM B4K674	EKV	24148051	-		○
	70	22,4	22,4	80 NBR B281	L 43	24251804	IP		●
	72	22,5	22,5	80 NBR B281	L 43	24251783	IP		●
	73	13,4	14	PTFE B602	L 27	24351815	IP		●
	74,5	5,9	6,3	PTFE GM201 / NBR	OMK-MR	24131861	IP		●
	74,5	5,9	6,3	PTFE B602 / NBR	OMK-MR	24178474	IP		●
	74,5	5,9	6,3	PTFE GM201 / FKM	OMK-MR	24196303	-		○
	74,5	5,9	6,3	PTFE B602 / FKM	OMK-MR	24315179	IP		●
	74,5	5,9	6,3	PTFE C104 / NBR	OMK-MR	49018496	-		○
	74,5	6	6,3	95 AU V142	OMK-PU	24341022	-		○
	74,5	6	6,3	98 AU 928	SK 300	417304	IP	●	●
	74,5	6,05	6,3	PA 4112	HDP 330	49036050	IP		●
	74,9	5,9	6,3	PTFE B602 / NBR	OMK-E	24276020	-		○
	74,9	5,9	6,3	PTFE GM201 / NBR	OMK-E	24276363	-		○
	74,9	5,9	6,3	PTFE B602 / FKM	OMK-E	24345119	-		○
	75	7,3	7,5	19YF / 80 A980	SPG	GS0310-V0	-	○	
	75	7,5	8,5	94 AU 925	AUN 1	12182 40421106	IP SP		● ●
	75	7,5	8,5	90 NBR 109	N 1	17431 40421524	IP SP		● ●
	75	9	10	94 U801	ODI	FU1017-H0	-	○	
	75	9,3	9,5	95 AU V142	T 18	24298858	IP		●
	75	10	11	94 U801	ODI	FU1018-H0	-	○	
	75	10,5	11	19YF / 80 NBR A980 / PA 12NM	SPGW	GS0609-V5	-	○	
	75	10,5	11	19YF / 85 HNBR G928 / PA 12NM	SPGW	GS0609-V7	-	○	
	75	12	13	94 AU 925	AUN 100	14368 40421225	IP SP		● ●
	75	12	13	80 NBR 878	NA 250	18475	IP		●
	75	12	13	94 AU 925	NA 300	373006 40421936	IP SP		● ●
76	6,3	6,5	19YF / 70 A305	SPGO	GS1821-V0	-	○		
76	16	16,5	80 NBR 878	SK 520	116822	-		○	
76	32,9	32,9	80 NBR 878	SK 320	10696	IP		●	
77,8	7,3	7,5	PTFE 177023	TFMA	97029	IP	○	●	

D [mm]	d [mm]	H [mm]	L [mm]	Material	Design	Part No.	PU ¹⁾	US	EU
	80	6	7	94 U801	OSI	FU1019-L0	-	○	
	80	6	7	94 U641	OUIS	FU1019-P0	-	○	
	80	6	7	94 U801	OUIS	FU1019-P1	-	○	
	80	7	7,5	31BF / 70 A305	SPGC	GS1063-F0	-	○	
90	80	8	9	94 U801	ODI	FU1020-H0	-	○	
	80	10	11	94 AU 925	AUN 100	12197 40421108	IP SP		●
	80	11,65	12,5	95 AU V142	T 19	24314955	IP		●
	80,6	6,6	7,1	PTFE F56110	FOA	422328	IP		●
92,1	77	5,9	6,3	PTFE B602 / NBR	OMK-E	24332799	-		○
	63	15	16	90 NBR 109	N 1	16865	-		○
93	77,5	5,9	6,3	PTFE B602 / NBR	OMK-MR	24328140	-		○
	80	8	9	90 NBR 109	N 1	16964	-		○
94	78,9	5,9	6,3	PTFE GM201 / FKM	OMK-E	533173	-		○
	25	16	3	88 NBR 101	T MF	15374	-		○
	38	15	3,5	88 NBR 101	T OF	15377	-		○
	55	16	3,8	94 U823	CPI	FC0164-C0	-	○	
	70	12	13	94 AU 925	AUN 1	14466	-		○
	70	12	13	90 NBR 109	N 1	16900	-		○
	70	15	16	90 NBR 109	N 100	17938	-		○
	74	7,7	8,1	PTFE GM201 / NBR	OMK-MR	24075603	-		○
	74	7,7	8,1	PTFE B602 / NBR	OMK-MR	24213792	-		○
	74	7,7	8,1	PTFE B602 / FKM	OMK-MR	24348837	-		○
	75	10	11	90 NBR 109	N 1	16935 40421498	IP SP		●
	75	12	13	94 AU 925	AUN 100	14478 40421250	IP SP		●
	75	12	13	90 NBR 109	N 100	18067 40421577	IP SP		●
	75	12	13	80 NBR 878	NA 250	18478	-		○
	75	12	13	94 U801	ODI	FU1045-H0	-	○	
	75	15	16	94 U801	ODI	FU1046-H0	-	○	
	75	22,4	22,4	80 NBR B281	L 43	529747	IP		●
95	79,5	5,9	6,3	PTFE GM201 / NBR	OMK-MR	24199482	-		○
	79,5	5,9	6,3	PTFE B602 / NBR	OMK-MR	24213794	IP		●
	79,5	5,9	6,3	PTFE B602 / FKM	OMK-MR	24266812	-		○
	79,5	5,9	6,3	PTFE C104 / FKM	OMK-MR	49042243	-		○
	79,5	6	6,3	98 AU 928	SK 300	416503	IP	○	●
	79,5	6,3	6,3	PTFE C104 / NBR	OMK-MR	49000291	-		○
	79,9	5,9	6,3	PTFE GM201 / NBR	OMK-E	24245655	-		○
	79,9	5,9	6,3	PTFE B602 / NBR	OMK-E	24259254	-		○
	79,9	5,9	6,3	PTFE B602 / FKM	OMK-E	24345120	-		○
	79,9	5,9	6,3	PTFE B602 / FKM	OMK-E	24356575	-		○
	80	7,3	7,5	19YF / 80 A980	SPG	GS0346-V0	-	○	
	80	7,5	8,5	90 NBR 109	N 1	16965	-		○
	80	9	10	94 U801	ODI	FU1047-H0	-	○	
	80	9	10	A505	OUHR	CU2605-Q2	-	○	
	80	9	10	A567	OUHR	CU2605-Q4	-	○	
	80	10	11	94 U801	ODI	FU1048-H0	-	○	
	80	10,5	11	19YF / 80 NBR A980 / PA 12NM	SPGW	GS0481-V5	-	○	
	80	10,5	11	19YF / 85 HNBR G928 / PA 12NM	SPGW	GS0481-V6	-	○	

D [mm]	d [mm]	H [mm]	L [mm]	Material	Design	Part No.	PU ¹⁾	US	EU
95	80	12	13	94 AU 925	AUN 100	14369 40421226	IP SP		● ●
	80	12	13	94 AU 925	NA 300	401303 40421943	IP SP		● ●
	81	6,3	6,5	19YF / 70 A305	SPGO	GS1822-V0	-	○	
	82,8	7,3	7,5	PTFE 177023	TFMA	97030	-		○
	85	7	7,5	31BF / 70 A305	SPGC	GS1064-F0	-	○	
	85,6	6,6	7,1	PTFE F56110	FOA	389792	IP		●
98	82,5	5,9	6,3	PTFE GM201 / NBR	OMK-MR	24296693	-		○
	86	12	13	90 NBR 109	N 1	11675	-		○
100	0	22	4	88 NBR 101	T OF	15402	-		○
	12	35		90 NBR 109	TDUOH	9755	-	○	●
	15	10	3	88 NBR 101	T MF	15386	-		○
	28	18	4	88 NBR 101	T OF	15383	-		○
	38	15	4,3	80 NBR 104	CPH	CC0171-C0	-	○	
	42	18	4	88 NBR 101	T OF	15387 40421321	IP SP		● ●
	50	16	4	80 NBR 104	CPH	CC0174-C5	-	○	
	55	16	3,8	94 U824	CPI	FC0174-C0	-	○	
	55	16	4	90 NBR A505	CPH	CC0174-C4	-	○	
	60	15	3	88 NBR 101	T MF	15397 40421322	IP SP		● ●
	60	15	3	88 NBR 101	T OF	15398 40421323	IP SP		● ●
	64	12	3	88 NBR 101	T OF	15413	-		○
	65	10	3	88 NBR 101	T OF	15388	-		○
	68	15	4	88 NBR 101	T OF	15409	-		○
	70	15	16	90 NBR 109	N 1	16901	-		○
	75	10	2,5	88 NBR 101	T MF	15381 40421320	IP SP		● ●
	75	12	13	90 NBR 109	N 1	16936	-		○
	75	15	16	90 NBR 109	N 1	16934	-		○
	75	15	16	90 NBR 109	N 100	16943	-		○
	75	15	16	80 NBR 878	NA 400	25427	-		○
	75	22,4	22,4	80 NBR B281	L 43	24251789	IP		●
	78	12	3	88 NBR 101	T OF	15389	-		○
	79	7,7	8,1	PTFE GM201 / NBR	OMK-MR	24077512	IP		●
	79	7,7	8,1	PTFE B602 / NBR	OMK-MR	24213796	IP		●
	79	7,7	8,1	PTFE B602 / FKM	OMK-MR	24348838	-		○
	79	7,7	8,1	PTFE GM201 / FKM	OMK-MR	49032882	-		○
	79	7,8	8,1	PA 4112	HDP 330	49064716	IP		●
79	7,8	8,1	98 AU 928	SK 300	416504	IP	○	●	
80	9,6	10	PTFE GM201	OMK-S	24096105	IP		●	
80	10	11	94 AU 925	AUN 1	14482 40421251	IP SP		● ●	
80	10	11	90 NBR 109	N 1	17367 40421522	IP SP		● ●	
80	12	13	94 AU 925	AUN 100	14271 40421187	IP SP		● ●	
80	12	13	90 NBR 109	N 100	16974 40421500	IP SP	○	● ●	
80	12	13	94 AU 925	NA 300	21771 40421683	IP SP		● ●	
80	12	13	80 NBR 878	NA 400	25415	IP		●	
80	12	13	94 U801	ODI	FU1072-H0	-	○		

D [mm]	d [mm]	H [mm]	L [mm]	Material	Design	Part No.	PU ¹⁾	US	EU
	80	12,2	12,5	95 AU V142	T 18	24245861	IP		●
	80	12,2	13	95 AU V142	T 18	24245886	IP		●
	80	15	16	90 NBR 109	N 100	17636 40421528	IP SP		● ●
	80	15	16	80 NBR 878	NA 250	18479	IP		●
	80	15	16	94 U801	ODI	FU1074-H0	-	○	
	80	20,6	21,2	BHNBR B4B246	EK	24070164	IP		●
	80	20,6	21,2	BHFKM B4K674	EKV	24139296	IP		●
	82	9	10	90 NBR 109	N 1	16977	-		○
	82	22,5	22,5	80 NBR B281	L 43	24251795	IP		●
	83	13,4	14	PTFE B602	L 27	24359198	IP		●
	84,5	5,9	6,3	PTFE B602 / FKM	OMK-E	49062069	-		○
	84,5	5,9	6,3	PTFE B602 / NBR	OMK-E	49062070	-		○
	84,5	5,9	6,3	PTFE GM201 / NBR	OMK-E	49062071	-		○
	84,5	5,9	6,3	PTFE GM201 / NBR	OMK-MR	24107904	IP		●
	84,5	5,9	6,3	PTFE B602 / NBR	OMK-MR	24178475	IP		●
	84,5	5,9	6,3	PTFE B602 / FKM	OMK-MR	24257247	IP		●
	84,5	5,9	6,3	PTFE C104 / NBR	OMK-MR	49002075	-		○
	84,5	6	6,3	95 AU V142	OMK-PU	24333983	-		○
	84,5	6	6,3	98 AU 928	SK 300	417305	IP	○	●
	84,5	6,05	6,3	PA 4112	HDP 330	49036102	IP		●
	84,9	5,9	6,3	PTFE GM201 / NBR	OMK-E	24148860	IP		●
	84,9	5,9	6,3	PTFE B602 / NBR	OMK-E	24275986	IP		●
	84,9	5,9	6,3	PTFE B602 / FKM	OMK-E	24338059	-		○
100	85	7,3	7,5	19YF / 80 A980	SPG	GS0347-V0	-	○	
	85	7,5	8,5	90 NBR 109	N 1	16993 40421502	IP SP		● ●
	85	9	10	94 U801	OSI	FU1078-L0	-	○	
	85	9	10	A505	OUHR	CU2669-Q2	-	○	
	85	9	10	A567	OUHR	CU2669-Q3	-	○	
	85	9	10	94 U641	OUIS	FU1078-P0	-	○	
	85	9	10	94 U801	OUIS	FU1078-P1	-	○	
	85	9,3	9,5	95 AU V142	T 18	24269439	IP		●
	85	10	11	94 U801	ODI	FU1079-H0	-	○	
	85	11,8	13	80 NBR B246	Seal Set 0215	24140707	-		○
	85	12	12,5	BHNBR B3B246	EK	24073568	-		○
	85	12	12,5	19YF / 80 NBR A980 / PA 12NM	SPGW	GS0610-V6	-	○	
	85	12	12,5	19YF / 85 HNBR G928 / PA 12NM	SPGW	GS0610-V8	-	○	
	85	12	13	94 AU 925	AUN 100	12109 40421104	IP SP		● ●
	85	12	13	80 NBR 878	NA 250	18480	IP		●
	85	12	13	94 AU 925	NA 300	21775 40421684	IP SP		● ●
	86	6,3	6,5	19YF / 70 A305	SPGO	GS1823-V0	-	○	
	86	16	16,5	80 NBR 878	SK 520	423522	IP		●
	86	32,9	32,9	80 NBR 878	SK 320	10700	IP		●
	87,8	7,3	7,5	PTFE 177023	TFMA	97031	IP		●
	88	6	7	90 NBR 109	N 1	16999 40421503	IP SP		● ●
	88	8,5	9,5	80 NBR 878	NA 150	84525 40421764	IP SP		● ●

D [mm]	d [mm]	H [mm]	L [mm]	Material	Design	Part No.	PU ¹⁾	US	EU	
100	89	4	4,2	PTFE B602 / NBR	OMK-MR	24259017	-		○	
	89	4	4,2	PTFE GM201 / NBR	OMK-MR	24328829	-		○	
	89,3	4,2	4,2	PTFE GM201 / FKM	OMK-E	49008314	-		○	
	90	7	7,5	31BF / 70 A305	SPGC	GS1065-F0	-	○		
	90	11,6	12,5	95 AU V142	T 19	24314956	IP		●	
	90,6	6,6	7,1	PTFE F56110	FOA	366343	IP		●	
101,6	86,1	5,9	6,3	PTFE GM201 / NBR	OMK-MR	24264218	-		○	
	86,1	5,9	6,3	PTFE B602 / NBR	OMK-MR	24342417	-		○	
	86,5	5,9	6,3	PTFE B602 / NBR	OMK-E	24352794	-		○	
102	21	21	3	88 NBR 101	T OF	15422 40421324	IP SP		● ●	
	78	12	13	90 NBR 109	N 1	16951	-		○	
103	15	15	3	88 NBR 101	T MF	15423	-		○	
104	88,5	5,9	6,3	PTFE B602 / NBR	OMK-MR	24376184	-		○	
105	60	16	3,8	94 U825	CPI	FC0187-C0	-	○		
	75	15	16	90 NBR 109	N 1	16939	-		○	
	80	12	3	88 NBR 101	T OF	15424 40421325	IP SP		● ●	
	80	12	13	90 NBR 109	N 1	16963	-		○	
	80	15	16	90 NBR 109	N 100	17939	-		○	
	80	22,5	22,5	80 NBR B281	L 43	24330610	IP		●	
	85	10	11	90 NBR 109	N 1	16989 40421501	IP SP		● ●	
	85	12	13	94 AU 925	AUN 100	14341 40421201	IP SP		● ●	
	85	12	13	90 NBR 109	N 1	16988	-		○	
	85	12,2	13	95 AU V142	T 18	24345515	IP		●	
	85	15	16	90 NBR 109	N 100	18019 40421571	IP SP		● ●	
	85	15	16	80 NBR 878	NA 250	18484	IP		●	
	85	15	16	94 U801	ODI	FU2166-H0	-	○		
	85	18	19	94 AU 925	AUN 1	14296	-		○	
	88	13,4	14	PTFE B602	L 27	24346227	IP		●	
	105	89,5	5,9	6,3	PTFE GM201 / FKM	OMK-MR	24170834	-		○
		89,5	5,9	6,3	PTFE GM201 / NBR	OMK-MR	24187281	-		○
		89,5	5,9	6,3	PTFE B602 / NBR	OMK-MR	24213798	IP		●
		89,5	5,9	6,3	PTFE B602 / FKM	OMK-MR	24348381	-		○
		89,5	5,9	6,3	PTFE C104 / NBR	OMK-MR	49018497	-		○
		89,5	6	6,3	98 AU 928	SK 300	416505	IP		●
		89,9	5,9	6,3	PTFE GM201 / NBR	OMK-E	24187342	-		○
		89,9	5,9	6,3	PTFE B602 / NBR	OMK-E	24275948	-		○
		89,9	5,9	6,3	PTFE B602 / FKM	OMK-E	24345121	-		○
		89,9	5,9	6,3	PTFE GM201 / FKM	OMK-E	24355419	-		○
		90	7,3	7,5	19YF / 80 A980	SPG	GS3509-V0	-	○	
		90	7,5	8,5	90 NBR 109	N 1	17009 40421505	IP SP		● ●
90		9	10	94 U801	OSI	FU1120-L0	-	○		
90		9	10	94 U641	OUIS	FU1120-P0	-	○		
90	9	10	94 U801	OUIS	FU1120-P1	-	○			
90	12	12,5	19YF / 80 NBR A980 / PA 12NM	SPGW	GS0973-V5	-	○			
90	12	12,5	19YF / 85 HNBR G928 / PA 12NM	SPGW	GS0973-V7	-	○			
90	12	13	94 AU 925	AUN 100	14370 40421227	IP SP		● ●		

D [mm]	d [mm]	H [mm]	L [mm]	Material	Design	Part No.	PU ¹⁾	US	EU
	90	12	13	80 NBR 878	NA 250	18481	IP		●
	91	6,3	6,5	19YF / 70 A305	SPGO	GS1824-V0	-	○	
105	91	15,2	16,5	93 AU V167	T 42	24367987	-		○
	91	16	16,5	80 NBR 878	SK 520	114022	-		○
	92,8	7,3	7,5	PTFE 177023	TFMA	363282	-		○
	95	7	7,5	31BF / 70 A305	SPGC	GS1066-F0	-	○	
	106	60	16	3,8	94 U826	CPI	FC0189-C0	-	○
107	91,5	5,9	6,3	PTFE B602 / NBR	OMK-MR	49041425	-		○
107,8	92,3	5,9	6,3	PTFE B602 / FKM	OMK-MR	24315420	-		○
108	92	7,3	7,5	19YF / 80 A980	SPG	GS0348-V0	-	○	
	10	7	7,5	31BF / 70 A305	SPGC	GS1067-F0	-	○	
	12	40		90 NBR 109	TDUOH	9762	-		○
	46	16	3	88 NBR 101	T MF	15435 40421327	IP SP		● ●
	60	16	3,8	94 U827	CPI	FC0195-C0	-	○	
	70	15	3	88 NBR 101	T OF	15433 40421326	IP SP		● ●
	80	15	16	94 AU 925	AUN 1	14483	-		○
	80	15	16	90 NBR 109	N 1	16960	-		○
	85	12	13	90 NBR 109	N 1	16990	-	○	○
	85	15	16	90 NBR 109	N 100	16997	-		○
	85	15	16	80 NBR 878	NA 250	17614	-		○
	85	22,4	22,4	80 NBR B281	L 43	24251800	IP		●
	85	28,5	28,5	93 AU V167	T 44	24368011	-		○
	89	7,7	8,1	PTFE GM201 / NBR	OMK-MR	24077514	-		○
	89	7,7	8,1	PTFE B602 / NBR	OMK-MR	24213802	IP		●
	89	7,8	8,1	PA 4112	HDP 330	49036072	IP		●
	89	7,8	8,1	98 AU 928	SK 300	417307	IP	○	●
	89	10	10,5	98 AU 928	SK 300	416507	-		○
110	90	9,4	10	PTFE GM201	OMK-ES	24351403	-		○
	90	9,6	10	PTFE GM201	OMK-S	24096106	-		○
	90	9,6	10	PTFE B602	OMK-S	24230204	-		○
	90	9,6	10	PTFE GM201	OMK-S	24371157	-		○
	90	10	11	90 NBR 109	N 1	17007 40421504	IP SP		● ●
	90	12	13	94 AU 925	AUN 100	14371 40421228	- SP	○	● ●
	90	12	13	94 AU 925	NA 300	363173	-		○
	90	12	13	80 NBR 878	NA 400	30021	IP	○	●
	90	12	13	94 U801	ODI	FU1149-H0	-	○	
	90	12,2	12,5	95 AU V142	T 18	24245862	IP		●
90	12,2	13	95 AU V142	T 18	24245887	IP		●	
90	15	16	90 NBR 109	N 100	17856 40421552	IP SP		● ●	
90	15	16	80 NBR 878	NA 250	18486	-		○	
90	15	16	94 U801	ODI	FU1150-H0	-	○		
90	18	19	94 AU 925	AUN 1	14500	-		○	
90	20	21,2	BH-NBR B4B246	EK	24070165	IP		●	
90	20,6	21,2	BHFKM B4K674	EKV	24144307	-		○	
92	22,5	22,5	80 NBR B281	L 43	24251805	IP		●	
93	13,4	14	PTFE B602	L 27	24360184	IP		●	
94	7,3	7,5	19YF / 80 A980	SPG	GS0311-V0	-	○		

D [mm]	d [mm]	H [mm]	L [mm]	Material	Design	Part No.	PU ¹⁾	US	EU
110	94,5	5,9	6,3	PTFE GM201 / NBR	OMK-MR	24131862	IP		●
	94,5	5,9	6,3	PTFE B602 / NBR	OMK-MR	24178476	IP		●
	94,5	5,9	6,3	PTFE B602 / FKM	OMK-MR	24337969	-		○
	94,5	6	6,3	95 AU V142	OMK-PU	24341023	-		○
	94,5	6	6,3	98 AU 928	SK 300	416508	IP	○	●
	94,5	6,3	6,3	PTFE C104 / NBR	OMK-MR	49020706	-		○
	94,9	5,9	6,3	PTFE B602 / NBR	OMK-E	24276006	IP		●
	94,9	5,9	6,3	PTFE GM201 / NBR	OMK-E	24276350	-		○
	94,9	5,9	6,3	PTFE B602 / FKM	OMK-E	24345122	-		○
	95	7,5	8,5	90 NBR 109	N 1	17021	-		○
	95	9	10	94 U801	OSI	FU1152-L0	-	○	
	95	9	10	A505	OUHR	CU2607-Q2	-	○	
	95	9	10	A567	OUHR	CU2607-Q3	-	○	
	95	9	10	94 U641	OUIS	FU1152-P0	-	○	
	95	9	10	94 U801	OUIS	FU1152-P1	-	○	
	95	10	11	94 U801	ODI	FU1153-H0	-	○	
	95	12	12,5	19YF / 80 NBR A980 / PA 12NM	SPGW	GS0611-V5	-	○	
	95	12	12,5	19YF / 85 HNBR G928 / PA 12NM	SPGW	GS0611-V6	-	○	
	95	12	13	94 AU 925	AUN 100	14372 40421229	-	○	●
	95	12	13	80 NBR 878	NA 250	18485	-		○
	95	12	13	94 AU 925	NA 300	401317 40421944	IP SP		●
	95	14,7	16	93 AU V167	T 42	24367988	-		○
	95	15	15,5	80 NBR 878	SK 520	309987	IP		●
	95	15	16	94 AU 925	AUN 1	12122	-		○
	96	6,3	6,5	19YF / 70 A305	SPGO	GS1825-V0	-	○	
	96	32,9	32,9	80 NBR 878	SK 320	10702	IP		●
	97,8	7,3	7,5	PTFE 177023	TFMA	363281	-		○
100	5	6	90 NBR 109	N 1	17034 40421509	IP SP		●	
100,6	6,6	7,1	PTFE F56110	FOA	422331	IP		●	
112	65	16	3,8	94 U828	CPI	FC0199-C0	-	○	
	91	7,7	8,1	PTFE C104 / NBR	OMK-MR	49054805	-		○
	92	12	13	94 U801	ODI	FU1174-H0	-	○	
	92	15	16	94 U801	ODI	FU1175-H0	-	○	
	96	7,3	7,5	19YF / 80 A980	SPG	GS0349-V0	-	○	
	96,5	5,9	6,3	PTFE B602 / NBR	OMK-MR	24328986	-		○
	97	9	10	94 U801	ODI	FU1176-H0	-	○	
	97	10	11	94 U801	ODI	FU1177-H0	-	○	
	98	6,3	6,5	19YF / 70 A305	SPGO	GS1826-V0	-	○	
	98	8,5	9,5	94 U801	OSI	FU2147-L0	-	○	
102	7	7,5	31BF / 70 A305	SPGC	GS1068-F0	-	○		
113,1	97,6	5,9	6,3	PTFE GM201 / NBR	OMK-MR	24357972	-		○
114	94	12,2	13	95 AU V142	T 18	24298411	-		○
115	10	9	10	94 U801	OSI	FU1193-L0	-	○	
	10	9	10	A567	OUHR	CU3241-Q2	-	○	
	10	9	10	94 U801	OUIS	FU1193-P0	-	○	
	10	9	10	94 U641	OUIS	FU1193-P1	-	○	
	10	12	12,5	19YF / 80 NBR A980 / PA 12NM	SPGW	GS0626-V5	-	○	

D [mm]	d [mm]	H [mm]	L [mm]	Material	Design	Part No.	PU ¹⁾	US	EU
	10	12	12,5	19YF / 85 HNBR G928 / PA 12NM	SPGW	GS0626-V6	-	○	
	76	11	3	88 NBR 101	T OF	15452 40421328	IP SP	○	●
	76	20	3	88 NBR 101	T MF	15451	-		○
	80	15	16	90 NBR 109	N 1	16961	-		○
	85	15	16	90 NBR 109	N 1	16991	-		○
	90	12	13	90 NBR 109	N 1	17008	-		○
	90	15	16	90 NBR 109	N 100	17011 40421506	IP SP		●
	90	15	16	80 NBR 878	NA 250	18491	-		○
	90	15	16	94 AU 925	NA 300	389161	-		○
	90	15	16	80 NBR 878	NA 400	35943	-	○	○
	94	7,7	8,1	PTFE GM201 / NBR	OMK-MR	24131890	-		○
	94	7,7	8,1	PTFE B602 / NBR	OMK-MR	24193795	IP		●
	94	7,7	8,1	PTFE B602 / O	OMK-MR	24348874	-		○
	94	7,8	8,1	PA 4112	HDP 330	49066516	IP		●
	94	7,8	8,1	98 AU 928	SK 300	416514 1460743	IP -	○	●
	95	9,6	10	PTFE GM201	OMK-S	24096107	-		○
	95	10	11	90 NBR 109	N 1	17019	-		○
	95	12	13	94 AU 925	AUN 100	14425 40421244	IP SP		●
	95	12,2	12,5	95 AU V142	T 18	24245863	IP		●
115	95	12,2	13	95 AU V142	T 18	24245888	IP		●
	95	15	16	90 NBR 109	N 100	17909 40421557	IP SP		●
	95	15	16	94 AU 925	NA 300	401318	-		○
	95	15	16	94 U801	ODI	FU2167-H0	-	○	
	95	18	19	94 AU 925	AUN 1	14253	-		○
	95	20,6	21,2	BHNBR B4B246	EK	24070166	IP		●
	95	20,6	21,2	BHFKM B4K674	EKV	24148052	-		○
	97	21	22,5	93 AU V167	T 42	24367989	-		○
	98	13,4	14	PTFE B602	L 27	24355371	-		○
	99,5	5,9	6,3	PTFE GM201 / NBR	OMK-MR	24131863	IP		●
	99,5	5,9	6,3	PTFE B602 / NBR	OMK-MR	24178477	IP		●
	99,5	5,9	6,3	PTFE GM201 / FKM	OMK-MR	24230030	-		○
	99,5	5,9	6,3	PTFE B602 / FKM	OMK-MR	24348382	-		○
	99,9	5,9	6,3	PTFE GM201 / NBR	OMK-E	24242319	-		○
	99,9	5,9	6,3	PTFE B602 / NBR	OMK-E	24275950	-		○
	99,9	5,9	6,3	PTFE B602 / FKM	OMK-E	24302827	-		○
	99,9	5,9	6,3	PTFE GM201 / FKM	OMK-E	533176	-		○
	100	12	13	94 AU 925	AUN 100	14373 40421230 1437344	IP SP -	○	●
	100	14,7	16	93 AU V167	T 42	24367990	-		○
	101	6,3	6,5	19YF / 70 A305	SPGO	GS1827-V0	-	○	
	105	7	7,5	31BF / 70 A305	SPGC	GS1069-F0	-	○	
	70	16	3,8	94 U829	CPI	FC0205-C0	-	○	
118	97	7,7	8,1	PTFE B602 / NBR	OMK-MR	49029193	-		○
	106	12	13	90 NBR 109	N 1	11691	-		○
	10	12	13	94 U801	ODI	FU1210-H0	-	○	
120	10	15	16	94 U801	ODI	FU1211-H0	-	○	

D [mm]	d [mm]	H [mm]	L [mm]	Material	Design	Part No.	PU ¹⁾	US	EU
	20	40		90 NBR 109	TDUOH	9771 9771-SIM	IP -	○	○
	30	14	4	88 NBR 101	T OF	15465	-		○
	30	20	3	88 NBR 101	T OF	15463	-		○
	60	16	4	60 NBR A102	CPH	CC0207-C0	-	○	
	70	16	3,8	94 U830	CPI	FC0207-C0	-	○	
	70	16	4	80 NBR 104	CPH	CC0207-C1	-	○	
	76	20	3	88 NBR 101	T OF	15458	-		○
	85	15	3,5	88 NBR 101	T MF	15459	-		○
	90	15	16	94 AU 925	AUN 1	14501 40421252	IP SP		● ●
	90	15	16	90 NBR 109	N 1	17005	-		○
	90	18	19	90 NBR 109	N 100	17940	-		○
	95	12	13	90 NBR 109	N 1	17020	-		○
	95	15	16	90 NBR 109	N 100	17832	-		○
	95	15	16	80 NBR 878	NA 250	18496	-		○
	95	22,4	22,4	80 NBR B281	L 43	24378461	IP		●
	95	24,5	25,3	BHNBR B4B246	EK	24071344	-		○
	99	7,7	8,1	PTFE GM201 / NBR	OMK-MR	24199999	-		○
	99	7,7	8,1	PTFE B602 / NBR	OMK-MR	24213807	IP		●
	99	7,7	8,1	PTFE B602 / FKM	OMK-MR	24348875	-		○
	99	7,8	8,1	PA 4112	HDP 330	49036074	IP		●
	99	7,8	8,1	98 AU 928	SK 300	410001	IP	○	●
	99	10	10,5	98 AU 928	SK 300	416515	IP	○	●
	99	14	3	88 NBR 101	T OF	15461 40421329	IP SP		● ●
120	100	9,4	10	PTFE GM201	OMK-ES	24380258	-		○
	100	9,6	10	PTFE GM201	OMK-S	24088300	-		○
	100	10	11	90 NBR 109	N 1	17032 40421508	IP SP		● ●
	100	12	13	94 AU 925	AUN 100	14286 40421189	- SP	○	● ●
	100	12	13	94 AU 925	NA 300	367812 40421933	IP SP		● ●
	100	12	13	80 NBR 878	NA 400	30026	-	○	○
	100	15	16	90 NBR 109	N 100	17697 40421535	IP SP	○	● ●
	100	15	16	80 NBR 878	NA 250	18494	-		○
	103	13,4	14	PTFE B602	L 27	24360185	-		○
	104	7,3	7,5	19YF / 80 A980	SPG	GS0350-V0	-	○	
	104,5	5,9	6,3	PTFE GM201 / NBR	OMK-MR	24186464	IP		●
	104,5	5,9	6,3	PTFE B602 / NBR	OMK-MR	24213805	IP		●
	104,5	5,9	6,3	PTFE B602 / FKM	OMK-MR	24348383	-		○
	104,5	5,9	6,3	PTFE C104 / NBR	OMK-MR	49018498	-		○
	104,5	6	6,3	95 AU V142	OMK-PU	24341024	-		○
	104,9	5,9	6,3	PTFE GM201 / NBR	OMK-E	24139834	-		○
	104,9	5,9	6,3	PTFE B602 / NBR	OMK-E	24258844	IP		●
	104,9	5,9	6,3	PTFE B602 / FKM	OMK-E	24345123	-		○
	105	8	9	90 NBR 109	N 1	17058	-		○
	105	9	10	94 U801	OSI	FU1212-L0	-	○	
	105	9	10	94 U641	OUIS	FU1212-P0	-	○	
	105	9	10	94 U801	OUIS	FU1212-P1	-	○	
	105	10	11	94 U801	ODI	FU1213-H0	-	○	

D [mm]	d [mm]	H [mm]	L [mm]	Material	Design	Part No.	PU ¹⁾	US	EU
	105	12	12,5	19YF / 80 NBR A980 / PA 12NM	SPGW	GS0612-V7	-	○	
	105	12	12,5	19YF / 85 HNBR G928 / PA 12NM	SPGW	GS0612-V8	-	○	
	105	14,7	16	93 AU V167	T 42	24367991	-		○
	105	15	15,5	80 NBR 878	SK 520	309907	-		○
120	106	6,3	6,5	19YF / 70 A305	SPGO	GS1828-V0	-	○	
	106	8,5	9,5	94 U801	OSI	FU2148-L0	-	○	
	106	32,9	32,9	80 NBR 878	SK 320	10707	IP		●
	107,8	7,3	7,5	PTFE 177023	TFMA	97035	-		○
	110	7	7,5	31BF / 70 A305	SPGC	GS1070-F0	-	○	
	110,6	6,6	7,1	PTFE F56110	FOA	162774	-		○
	106,5	5,9	6,3	PTFE B602 / NBR	OMK-MR	24302257	-		○
122	106,5	5,9	6,3	PTFE C104 / NBR	OMK-MR	49055074	-		○
	112	7	7,5	31BF / 70 A305	SPGC	GS1071-F0	-	○	
	20	40		90 NBR 109	TDUOH	9777	IP	○	●
	65	20	4	88 NBR 101	T MF	15475	-		○
	75	16	5	80 NBR 104	CPH	CC0219-C0	-	○	
	75	20	4,8	94 U831	CPI	FC0222-C0	-	○	
	88	18	3,5	88 NBR 101	T OF	15483	-		○
	95	14,5	15	PTFE GM201	OMK-S	24103524	-		○
	95	18	19	94 AU 925	NA 300	21778	-		○
	100	12	13	94 AU 925	AUN 1	14513	-		○
	100	12	13	90 NBR 109	N 1	17031 40421507	IP SP		● ●
	100	13	2,5	88 NBR 101	T MF	15484	-		○
	100	15	16	90 NBR 109	N 100	17716 40421537	IP SP		● ●
	100	15	16	80 NBR 878	NA 250	18501	-		○
	100	15	16	94 AU 925	NA 300	401339 40421945	IP SP		● ●
	100	15	16	80 NBR 878	NA 400	25452	IP		●
	100	15,2	15,5	95 AU V142	T 18	24245864	IP		●
	100	15,2	16	95 AU V142	T 18	24245889	IP		●
125	100	15,2	16,2	95 AU V142	T 18	24245865	IP		●
	100	23,5	23,5	93 AU V167	T 44	24368012	-		○
	100	25	25,8	BHNBR B4B246	EK	24070167	IP		●
	100	25	25,8	BHFKM B4K674	EKV	24099512	IP		●
	100	25,4	25,4	80 NBR B281	L 43	24267856	IP		●
	102	15,5	16	19YF / 80 NBR A980 / PA 12NM	SPGW	GS0583-V5	-	○	
	102	15,5	16	19YF / 85 HNBR G928 / PA 12NM	SPGW	GS0583-V6	-	○	
	103	26,5	26,5	80 NBR B281	L 43	24251784	IP		●
	104	7,7	8,1	PTFE GM201 / NBR	OMK-MR	24093346	-		○
	104	7,7	8,1	PTFE B602 / NBR	OMK-MR	24213809	IP		●
	104	7,7	8,1	PTFE B602 / FKM	OMK-MR	24340950	-		○
	104	7,7	8,1	PTFE GM201 / FKM	OMK-MR	49030798	-		○
	104	7,7	8,1	95 AU V142	OMK-PU	24341056	-		○
	104	7,8	8,1	PA 4112	HDP 330	49036075	IP		●
	104	7,8	8,1	98 AU 928	SK 300	416516	IP	○	●
	104	10	10,5	98 AU 928	SK 300	416517	IP	○	●
	104,5	7,6	8,1	PTFE B602 / FKM	OMK-E	24356576	-		○
	104,5	7,6	8,1	PTFE B602 / NBR	OMK-E	24356586	-		○

D [mm]	d [mm]	H [mm]	L [mm]	Material	Design	Part No.	PU ¹⁾	US	EU
125	104,5	7,6	8,1	PTFE GM201 / NBR	OMK-E	24356597	-		○
	105	9,4	10	PTFE GM201	OMK-ES	24351404	-		○
	105	9,4	10	PTFE B602	OMK-ES	49000473	-		○
	105	9,6	10	PTFE GM201	OMK-S	24096108	IP		●
	105	9,6	10	PTFE GM201	OMK-S	24196709	-		○
	105	10	11	90 NBR 109	N 1	17059 40421511	IP SP		● ●
	105	12	13	80 NBR 878	NA 400	25440	IP	○	●
	105	12	13	94 U801	ODI	FU1243-H0	-	○	
	105	12,2	12,5	95 AU V142	T 18	24288858	IP		●
	105	15	16	94 AU 925	AUN 100	14374 40421231	IP SP		● ●
	105	15	16	80 NBR 878	NA 250	18498	IP		●
	105	15	16	94 AU 925	NA 300	21784 40421685	IP SP		● ●
	105	15	16	94 U801	ODI	FU1244-H0	-	○	
	105	15	16	80 NBR B246	Seal Set 0215	24142955	-		○
	105	16	17	94 U801	ODI	FU1245-H0	-	○	
	108	13,4	14	PTFE B602	L 27	24355372	IP		●
	108	40,9	40,9	80 NBR 878	SK 320	10714	IP		●
	109	7,3	7,5	19YF / 80 A980	SPG	GS0351-V0	-	○	
	109,5	5,9	6,3	PTFE B602 / FKM	OMK-E	49062072	-		○
	109,5	5,9	6,3	PTFE B602 / NBR	OMK-E	49062073	-		○
	109,5	5,9	6,3	PTFE GM201 / NBR	OMK-E	49062074	-		○
	109,5	5,9	6,3	PTFE GM201 / NBR	OMK-MR	24109478	IP		●
	109,5	5,9	6,3	PTFE B602 / NBR	OMK-MR	24178478	IP		●
	109,5	5,9	6,3	PTFE B602 / FKM	OMK-MR	24245799	IP		●
	109,5	5,9	6,3	PTFE C104 / FKM	OMK-MR	49038796	-		○
	109,5	5,9	6,3	PTFE GM201 / FKM	OMK-MR	533178	-		○
	109,5	6	6,3	95 AU V142	OMK-PU	24341358	-		○
	109,5	6	6,3	98 AU 928	SK 300	418089	IP		●
	109,5	6,3	6,3	PTFE C104 / NBR	OMK-MR	49000292	-		○
	109,9	5,9	6,3	PTFE GM201 / NBR	OMK-E	24198545	-		○
	109,9	5,9	6,3	PTFE B602 / NBR	OMK-E	24274575	IP		●
	109,9	5,9	6,3	PTFE B602 / NBR	OMK-E	24275952	-		○
	109,9	5,9	6,3	PTFE B602 / FKM	OMK-E	24345124	-		○
	110	7,5	8,5	90 NBR 109	N 1	17039 40421510	IP SP		● ●
	110	9	10	94 U801	ODI	FU1247-H0	-	○	
	110	9	10	A567	OUHR	CU2670-Q2	-	○	
	110	10	11	80 NBR 878	NA 150	84526 40421765	IP SP		● ●
	110	10	11	94 U801	ODI	FU1248-H0	-	○	
	110	12	13	94 AU 925	AUN 1	14532	-		○
	110	14,7	16	93 AU V167	T 42	24346872	-		○
	110	14,7	16	93 AU V167	T 42	24367993	-		○
	110	15	16	94 AU 925	AUN 100	12144 40421105	IP SP	○	● ●
110	15,2	15,7	80 NBR 878	SK 520	309906	-		○	
111	6,3	6,5	19YF / 70 A305	SPGO	GS1829-V0	-	○		
112	8,5	9,5	94 U801	OSI	FU2847-L0	-	○		
112	8,5	9,5	A505	OUHR	CU3492-Q0	-	○		
112	8,5	9,5	94 U801	OUIS	FU2903-P0	-	○		

D [mm]	d [mm]	H [mm]	L [mm]	Material	Design	Part No.	PU ¹⁾	US	EU
125	112	8,5	9,5	94 U641	OUIS	FU2903-P1	-	○	
	112	9	10	94 U801	OSI	FU1926-L0	-	○	
	112	9	10	94 U641	OUIS	FU1926-P0	-	○	
	112	9	10	94 U801	OUIS	FU1926-P1	-	○	
	112,8	7,3	7,5	PTFE 177023	TFMA	97036	-		○
	115	7	7,5	31BF / 70 A305	SPGC	GS1072-F0	-	○	
	115,6	6,6	7,1	PTFE F56110	FOA	422333	IP		●
130	20	40		90 NBR 109	TDUOH	9781	-		○
	43	23	5	88 NBR 101	T OF	15503	-		○
	80	10	2,5	88 NBR 101	T MF	15501	-		○
	80	20	4,8	94 U832	CPI	FC0230-C0	-	○	
	80	20	5	80 NBR 104	CPH	CC0230-C1	-	○	
	100	15	16	94 AU 925	AUN 1	14514	-		○
	100	15	16	90 NBR 109	N 1	11687	-		○
	100	18	19	90 NBR 109	N 100	17825	-		○
	105	12	3	88 NBR 101	T OF	15504	-		○
	105	18	19	90 NBR 109	N 100	17941	-		○
	105	18,4	19	PTFE B602	L 27	24360186	-		○
	107	15,5	16	19YF / 80 NBR A980 / PA 12NM	SPGW	GS0613-V5	-	○	
	107	15,5	16	19YF / 85 HNBR G928 / PA 12NM	SPGW	GS0613-V7	-	○	
	109	7,7	8,1	PTFE GM201 / NBR	OMK-MR	24077517	-		○
	109	7,7	8,1	PTFE B602 / NBR	OMK-MR	24213811	-		○
	109	7,7	8,1	PTFE GM201 / FKM	OMK-MR	24246975	-		○
	109	7,7	8,1	PTFE B602 / FKM	OMK-MR	24348365	-		○
	109	7,8	8,1	PA 4112	HDP 330	49066510	IP		●
	109	7,8	8,1	98 AU 928	SK 300	409999	IP	○	●
	109,5	7,6	8,1	PTFE B602 / FKM	OMK-E	24356577	-		○
	109,5	7,6	8,1	PTFE B602 / NBR	OMK-E	24356587	-		○
	109,5	7,6	8,1	PTFE GM201 / NBR	OMK-E	24356598	-		○
	110	9,4	10	PTFE GM201	OMK-ES	531548	-		○
	110	9,6	10	PTFE GM201	OMK-S	24090826	-		○
	110	10	11	90 NBR 109	N 1	17065 40421512	IP SP		● ●
	110	12	13	94 U801	ODI	FU1274-H0	-	○	
	110	12,2	12,5	95 AU V142	T 18	24269441	IP		●
	110	15	16	94 AU 925	AUN 100	14298 40421192	SP	○	● ●
	110	15	16	80 NBR 878	NA 250	18504	-		○
	110	15	16	94 AU 925	NA 300	314121	-		○
	110	15	16	94 U801	ODI	FU1275-H0	-	○	
	110	16	17	94 U801	ODI	FU1276-H0	-	○	
110	18	19	94 AU 925	AUN 1	14530	-		○	
113	20	20,5	80 NBR 878	SK 520	114340	IP	○	●	
114	7,3	7,5	19YF / 80 A980	SPG	GS0352-V0	-	○		
114,5	5,9	6,3	PTFE GM201 / NBR	OMK-MR	24145852	-		○	
114,5	5,9	6,3	PTFE B602 / NBR	OMK-MR	24213813	IP		●	
114,5	5,9	6,3	PTFE B602 / FKM	OMK-MR	24348366	-		○	
114,5	5,9	6,3	PTFE C104 / NBR	OMK-MR	49041763	-		○	
114,9	5,9	6,3	PTFE B602 / NBR	OMK-E	24258843	-		○	
114,9	5,9	6,3	PTFE GM201 / NBR	OMK-E	24276371	-		○	

D [mm]	d [mm]	H [mm]	L [mm]	Material	Design	Part No.	PU ¹⁾	US	EU
130	114,9	5,9	6,3	PTFE B602 / FKM	OMK-E	24345125	-		○
	115	8,5	9,5	A505	OUHR	CU2609-Q2	-	○	
	115	8,5	9,5	A567	OUHR	CU2609-Q3	-	○	
	115	9	10	94 U801	OSI	FU1278-L0	-	○	
	115	9	10	94 U641	OUIS	FU1278-P0	-	○	
	115	9	10	94 U801	OUIS	FU1278-P1	-	○	
	115	10	11	94 U801	ODI	FU1279-H0	-	○	
	115	14,7	16	93 AU V167	T 42	24373713	-		○
	116	6,3	6,5	19YF / 70 A305	SPGO	GS1830-V0	-	○	
	117	9	9,5	PTFE F56110	FOA	434449	-		○
	117,8	7,3	7,5	PTFE 177023	TFMA	97037	-		○
	120	7	7,5	31BF / 70 A305	SPGC	GS1073-F0	-	○	
	132	85	20	4,8	94 U833	CPI	FC0233-C1	-	○
112		15	16	94 U801	ODI	FU2168-H0	-	○	
133	112	7,7	8,1	PTFE GM201 / NBR	OMK-MR	24244543	-		○
133,4	117,7	5,7	6,3	PTFE B602 / FKM	OMK-MR	24375986	-		○
135	110	12	13	90 NBR 109	N 1	17037	-		○
	110	18	19	90 NBR 109	N 100	17719 40421538	IP SP	○	● ●
	110	25,4	25,4	80 NBR B281	L 43	24380523	-		○
	112	15,5	16	19YF / 80 NBR A980 / PA 12NM	SPGW	GS0908-V5	-	○	
	112	15,5	16	19YF / 85 HNBR G928 / PA 12NM	SPGW	GS0908-V6	-	○	
	114	7,7	8,1	PTFE B602 / NBR	OMK-MR	24235337	-		○
	114	7,7	8,1	PTFE B602 / FKM	OMK-MR	24380547	-		○
	114	7,75	8,1	98 AU 928	SK 300	49014374	-		○
	114,5	7,6	8,1	PTFE B602 / FKM	OMK-E	24356578	-		○
	114,5	7,6	8,1	PTFE B602 / NBR	OMK-E	24356588	-		○
	114,5	7,6	8,1	PTFE GM201 / NBR	OMK-E	24356599	-		○
	115	15	16	94 AU 925	AUN 100	14375 40421232	- SP	○	● ●
	118	20	20,5	80 NBR 878	SK 520	124180	-		○
	119	7,3	7,5	19YF / 80 A980	SPG	GS0806-V1	-	○	
	119,9	5,9	6,3	PTFE B602 / NBR	OMK-E	24275954	-		○
	119,9	5,9	6,3	PTFE GM201 / NBR	OMK-E	24276272	-		○
	119,9	5,9	6,3	PTFE B602 / FKM	OMK-E	24345126	-		○
120	14,7	16	93 AU V167	T 42	24367994	-		○	
121	6,3	6,5	19YF / 70 A305	SPGO	GS1831-V0	-	○		
125	7	7,5	31BF / 70 A305	SPGC	GS1074-F0	-	○		
138,6	117,6	7,7	8,1	PTFE GM201 / NBR	OMK-MR	24355430	-		○
140	30	20	4	88 NBR 101	T OF	15527	-		○
	50	15	3	88 NBR 101	T OF	15523	-		○
	73	15	3,5	88 NBR 101	T MF	15517	-		○
	90	20	4,8	94 U834	CPI	FC0245-C1	-	○	
	92	28	3	88 NBR 101	T OF	15518	-		○
	100	20	21	90 NBR 109	N 1	17033	-		○
	110	15	16	94 AU 925	AUN 1	14529	-		○
	110	15	16	90 NBR 109	N 1	15905	-		○
	110	18	19	90 NBR 109	N 100	17942	-		○
	115	12	13	90 NBR 109	N 1	17073	-		○
	115	15	16	80 NBR 878	NA 250	17613	IP		●
	115	15,2	15,5	95 AU V142	T 18	24245890	IP		●

D [mm]	d [mm]	H [mm]	L [mm]	Material	Design	Part No.	PU ¹⁾	US	EU
	115	15,2	16,2	95 AU V142	T 18	24245866	IP		●
	115	18	19	90 NBR 109	N 100	17769 40421544	IP SP		● ●
	115	18,4	19	PTFE B602	L 27	24360788	-		○
	115	24	24	93 AU V167	T 44	24368015	-		○
	115	25	25,8	BHNBR B4B246	EK	24070168	IP		●
	115	25	25,8	BHFKM B4K674	EKV	24139362	IP		●
	115	25,4	25,4	80 NBR B281	L 43	24251790	IP		●
	117	15,5	16	19YF / 80 NBR A980 / PA 12NM	SPGW	GS0432V5	-	○	
	117	15,5	16	19YF / 85 HNBR G928 / PA 12NM	SPGW	GS0432V7	-	○	
	118	26,5	26,5	80 NBR B281	L 43	24251796	IP		●
	119	7,7	8,1	PTFE GM201 / NBR	OMK-MR	24075607	IP		●
	119	7,7	8,1	PTFE B602 / NBR	OMK-MR	24178479	IP		●
	119	7,7	8,1	PTFE B602 / FKM	OMK-MR	24236496	-		○
	119	7,7	8,1	95 AU V142	OMK-PU	24341047	-		○
	119	7,8	8,1	PA 4112	HDP 330	49064715	IP		●
	119	7,8	8,1	98 AU 928	SK 300	417954	IP	○	●
	119	8,1	8,1	PTFE C104 / NBR	OMK-MR	49000293	-		○
	119	10	10,5	98 AU 928	SK 300	416518	IP	○	●
	119,5	7,6	8,1	PTFE B602 / FKM	OMK-E	24356579	-		○
	119,5	7,6	8,1	PTFE B602 / NBR	OMK-E	24356589	-		○
	119,5	7,6	8,1	PTFE GM201 / NBR	OMK-E	24356600	-		○
	120	9,4	10	PTFE GM201	OMK-ES	24351116	-		○
	120	9,6	10	PTFE GM201	OMK-S	24096109	IP		●
140	120	9,6	10	PTFE GM201	OMK-S	24353223	-		○
	120	10	11	90 NBR 109	N 1	17084 40421514	IP SP		● ●
	120	12	13	94 AU 925	NA 300	401345	-		○
	120	12	13	80 NBR 878	NA 400	30030	IP		●
	120	12	13	94 U801	ODI	FU1316-H0	-	○	
	120	12,2	12,5	95 AU V142	T 18	24275200	IP		●
	120	15	16	94 AU 925	AUN 100	14311 40421194	IP SP		● ●
	120	15	16	94 U801	ODI	FU1317-H0	-	○	
	120	16	3	88 NBR 101	T OF	15526	-		○
	120	16	17	94 U801	ODI	FU1318-H0	-	○	
	123	22,7	22,7	93 AU V167	T 44	24368016	-		○
	123	40,9	40,9	80 NBR 878	SK 320	10738	IP		●
	124	7,3	7,5	19YF / 80 A980	SPG	GS0353-V0	-	○	
	124,9	5,9	6,3	PTFE B602 / NBR	OMK-E	24275990	IP		●
	124,9	5,9	6,3	PTFE GM201 / NBR	OMK-E	24276336	-		○
	124,9	5,9	6,3	PTFE B602 / FKM	OMK-E	24327625	-		○
	125	9	10	94 U801	OSI	FU1320-L0	-	○	
	125	9	10	A567	OUHR	CU2647-Q2	-	○	
	125	9	10	A505	OUHR	CU2647-Q3	-	○	
	125	9	10	94 U641	OUIS	FU1320-P0	-	○	
	125	9	10	94 U801	OUIS	FU1320-P1	-	○	
	125	10	11	80 NBR 878	NA 150	84527 40421766	IP SP		● ●
	125	10	11	94 U801	ODI	FU1321-H0	-	○	
	125	14,7	16	93 AU V167	T 42	24374443	-		○

D [mm]	d [mm]	H [mm]	L [mm]	Material	Design	Part No.	PU ¹⁾	US	EU
140	125	15	16	94 AU 925	AUN 100	12205 40421109	IP SP		● ●
	125	15	16	80 NBR 878	NA 250	2920	-		○
	125	15	16	94 AU 925	NA 300	401346	-		○
	125	15,4	15,9	80 NBR 878	SK 520	330336	-		○
	126	6,3	6,5	19YF / 70 A305	SPGO	GS1832-V0	-	○	
	127,8	7,3	7,5	PTFE 177023	TFMA	97039	-		○
	127,8	9	9,5	PTFE F56110	FOA	434451	IP		●
142	130	7	7,5	31BF / 70 A305	SPGC	GS1075-F0	-	○	
	121	7,7	8,1	PTFE B602 / NBR	OMK-MR	24343340	-		○
143	132	7	7,5	31BF / 70 A305	SPGC	GS1076-F0	-	○	
145	122	7,7	8,1	PTFE GM201 / NBR	OMK-MR	24146928	-		○
145	20	45		90 NBR 109	TDUOH	9786 9786-SIM	IP -	○	○
	100	15	3	88 NBR 101	T OF	15534 40421330	IP SP		● ●
	115	14,5	15	PTFE GM201	OMK-S	24108961	-		○
	120	18	19	90 NBR 109	N 100	17779	-		○
	122	15,5	16	19YF / 80 NBR A980 / PA 12NM	SPGW	GS0907-V1	-	○	
	122	15,5	16	19YF / 85 HNBR G928 / PA 12NM	SPGW	GS0907-V2	-	○	
	124	7,7	8,1	PTFE B602 / NBR	OMK-MR	24236854	-		○
	125	10	11	90 NBR 109	N 1	17089	-		○
	125	15	16	94 AU 925	AUN 100	14386 40421235	IP SP		● ●
	129	7,3	7,5	19YF / 80 A980	SPG	GS0885-V0	-	○	
	129,9	5,9	6,3	PTFE B602 / NBR	OMK-E	24351730	-		○
	130	9	10	94 U801	OSI	FU2405-L0	-	○	
	135	7	7,5	31BF / 70 A305	SPGC	GS1077-F0	-	○	
146	116	14,5	15	PTFE GM201	OMK-S	24259120	-		○
149	128	7,7	8,1	PTFE GM201 / NBR	OMK-MR	24379530	-		○
149	128	7,7	8,1	PTFE GM201 / FKM	OMK-MR	24380118	-		○
	128	8,1	8,1	PTFE C104 / NBR	OMK-MR	49000294	-		○
150	10	20	4,8	94 U835	CPI	FC0255-C1	-	○	
	10	20	5	90 NBR A505	CPH	CC0255-C2	-	○	
	20	40		90 NBR 109	TDUOH	9791	IP		●
	35	25	4	88 NBR 101	T OF	13457	-		○
	75	20	5	60 NBR A102	CPH	CC0255-C0	-	○	
	110	15	3	88 NBR 101	T MF	15543 40421331	IP SP		● ●
	120	15	16	90 NBR 109	N 1	17082 40421513	IP SP		● ●
	120	18	19	90 NBR 109	N 100	17943 40421564	IP SP		● ●
	120	18	19	94 AU 925	NA 300	21788	-		○
	120	18,6	19	95 AU V142	T 18	24245891	IP		●
	120	18,6	19,8	95 AU V142	T 18	24245867	IP		●
	120	28	29	BHNBR B4B246	EK	24070169	IP		●
	120	28	29	BHKM B4K674	EKV	24144511	-		○
	120,5	16	4	88 NBR 101	T OF	15542	-		○
	125	12,1	12,5	PTFE GM201	OMK-S	24090827	-		○
125	12,1	12,5	PTFE GM201	OMK-S	49003034	-		○	
125	15	16	80 NBR 878	NA 400	30033	-		○	

D [mm]	d [mm]	H [mm]	L [mm]	Material	Design	Part No.	PU ¹⁾	US	EU
	125	18	19	90 NBR 109	N 100	17944 40421565	IP SP		● ●
	125	18,4	19	PTFE B602	L 27	24361316	-		○
	125	19	20	94 U801	ODI	FU2169-H0	-	○	
	125	20	21	94 U801	ODI	FU1351-H0	-	○	
	127	15,5	16	19YF / 80 NBR A980 / PA 12NM	SPGW	GS0614-V5	-	○	
	127	15,5	16	19YF / 85 HNBR G928 / PA 12NM	SPGW	GS0614-V7	-	○	
	128	26,5	26,5	80 NBR B281	L 43	24266979	IP		●
	129	7,7	8,1	PTFE GM201 / NBR	OMK-MR	24075609	IP		●
	129	7,7	8,1	PTFE B602 / NBR	OMK-MR	24178480	IP		●
	129	7,7	8,1	PTFE GM201 / FKM	OMK-MR	24258204	-		○
	129	7,7	8,1	PTFE B602 / FKM	OMK-MR	24340951	-		○
	129	7,7	8,1	PTFE C104 / NBR	OMK-MR	49018499	-		○
	129	7,8	8,1	PA 4112	HDP 330	49083057	IP		●
	129	7,8	8,1	98 AU 928	SK 300	49031265	-	○	○
	129	10	10,5	98 AU 928	SK 300	416519	IP	○	●
	129,5	7,6	8,1	PTFE B602 / FKM	OMK-E	24356580	-		○
	129,5	7,6	8,1	PTFE B602 / NBR	OMK-E	24356590	-		○
	129,5	7,6	8,1	PTFE GM201 / NBR	OMK-E	24356601	-		○
	130	10	11	90 NBR 109	N 1	17103 40421515	IP SP	○	● ●
	130	12	13	94 U801	ODI	FU1352-H0	-	○	
	130	12,2	12,5	95 AU V142	T 18	24265868	IP		●
	130	15	16	94 AU 925	AUN 100	14293 40421190	- SP	○	● ●
150	130	15	16	94 AU 925	NA 300	21790 40421686	IP SP		● ●
	130	16	17	94 U801	ODI	FU1354-H0	-	○	
	130	16,8	17,5	PTFE B602	L 27	24181687	-		○
	130	28,5	28,5	93 AU V167	T 44	24368017	-		○
	133	18,5	20	93 AU V167	T 42	24373891	-		○
	133	40,9	40,9	80 NBR 878	SK 320	10751	IP		●
	134	7,3	7,5	19YF / 80 A980	SPG	GS0354-V0	-	○	
	134,5	5,9	6,3	PTFE B602 / NBR	OMK-MR	49015512	-		○
	134,9	5,9	6,3	PTFE B602 / NBR	OMK-E	24275956	-		○
	134,9	5,9	6,3	PTFE GM201 / NBR	OMK-E	24276274	-		○
	134,9	5,9	6,3	PTFE B602 / FKM	OMK-E	24345127	-		○
	134,9	5,9	6,3	PTFE C104 / NBR	OMK-E	49036061	-		○
	135	9	10	94 U801	OSI	FU1356-L0	-	○	
	135	9	10	94 U641	OUIS	FU1356-P0	-	○	
	135	9	10	94 U801	OUIS	FU1356-P1	-	○	
	135	10	11	90 NBR 109	N 1	11701 40421081	IP SP		● ●
	135	10	11	94 U801	ODI	FU1357-H0	-	○	
	135	15	15,5	80 NBR 878	SK 520	309903	-		○
	136	6,3	6,5	19YF / 70 A305	SPGO	GS1833-V0	-	○	
	136	8,5	9,5	94 U801	OSI	FU2149-L0	-	○	
	136	8,5	9,5	A505	OUHR	CU3244-Q1	-	○	
	136	8,5	9,5	94 U801	OUIS	FU2149-P0	-	○	
	136	8,5	9,5	94 U641	OUIS	FU2149-P1	-	○	
	136,8	7,3	7,5	PTFE 177023	TFMA	98759	-		○
	137,8	9	9,5	PTFE F56110	FOA	373520	IP		●

D [mm]	d [mm]	H [mm]	L [mm]	Material	Design	Part No.	PU ¹⁾	US	EU
150	140	7	7,5	31BF / 70 A305	SPGC	GS1078-F0	-	○	
152,4	131,3	7,6	8,1	PTFE B602 / FKM	OMK-MR	24375985	-		○
152,7	131,7	7,7	8,1	PTFE GM201 / NBR	OMK-MR	24235246	-		○
155	80	24	5	88 NBR 101	T OF	15554	-		○
	125	15	16	90 NBR 109	N 1	17090	-		○
	125	28,5	28,5	93 AU V167	T 44	24368018	-		○
	130	18	19	90 NBR 109	N 100	17945	-		○
	134	7,7	8,1	PTFE GM201 / NBR	OMK-MR	24361559	-		○
	134	7,7	8,1	PTFE B602 / NBR	OMK-MR	24377858	-		○
	135	15	16	94 AU 925	AUN 100	14376 40421233	IP SP		● ●
	139	7,3	7,5	19YF / 80 A980	SPG	GS3133-V1	-	○	
	140	9	10	94 U801	OSI	FU1386-L0	-	○	
145	7	7,5	31BF / 70 A305	SPGC	GS1079-F0	-	○		
156	140,9	5,9	6,3	PTFE B602 / NBR	OMK-E	24339271	-		○
157	132	20	21	94 U801	ODI	FU1909-H0	-	○	
	136	7,7	8,1	PTFE GM201 / NBR	OMK-MR	24190723	-		○
160	20	40		90 NBR 109	TDUOH	9795	IP		●
	80	24	5	88 NBR 101	T OF	15557	-		○
	110	15	3,5	88 NBR 101	T OF	15561	-		○
	110	20	4,8	94 U836	CPI	FC0275-C0	-	○	
	130	15	16	94 AU 925	AUN 1	14560	-		○
	130	15	16	90 NBR 109	N 1	17101	-		○
	130	17,2	19	95 AU V142	TM 21	24370477	IP		●
	130	18	19	90 NBR 109	N 100	17853 40421551	IP SP		● ●
	130	18	19	94 AU 925	NA 300	21793	-		○
	130	18	19	80 NBR 878	NA 400	25474	-		○
	130	18,6	19	95 AU V142	T 18	24245892	IP		●
	130	18,6	19,8	95 AU V142	T 18	24245868	IP		●
	130	25,4	25,4	80 NBR B281	L 43	24251801	IP		●
	130	28	29	BHNBR B4B246	EK	24070170	IP		●
	130	28	29	BHFKM B4K674	EKV	24099516	IP		●
	135	11,7	12,5	PTFE GM201	OMK-ES	24351168	-		○
	135	12	13	90 NBR 109	N 1	11702 40421082	IP SP		● ●
	135	12,1	12,5	PTFE GM201	OMK-S	24096110	IP		●
	135	12,1	12,5	PTFE GM201	OMK-S	24096864	-		○
	135	15	16	80 NBR 878	NA 400	25464	IP		●
	135	18	19	90 NBR 109	N 100	17877 40421555	IP SP	○	● ●
	135	18	19	80 NBR 878	NA 250	21094	-		○
	135	18,4	19	PTFE B602	L 27	24361317	-		○
135	19	20	94 U801	ODI	FU2170-H0	-	○		
135	20	21	94 U801	ODI	FU1398-H0	-	○		
137	15,5	16	19YF / 80 NBR A980 / PA 12NM	SPGW	GS0615-V5	-	○		
137	15,5	16	19YF / 85 HNBR G928 / PA 12NM	SPGW	GS0615-V8	-	○		
138	26,5	26,5	80 NBR B281	L 43	24251785	IP		●	
138	28,5	28,5	93 AU V167	T 44	24362541	-		○	
139	7,7	8,1	PTFE GM201 / NBR	OMK-MR	24075673	-		○	
139	7,7	8,1	PTFE GM201 / FKM	OMK-MR	24195956	-		○	

D [mm]	d [mm]	H [mm]	L [mm]	Material	Design	Part No.	PU ¹⁾	US	EU
160	139	7,7	8,1	PTFE B602 / NBR	OMK-MR	24213816	IP		●
	139	7,7	8,1	PTFE B602 / FKM	OMK-MR	24267553	IP		●
	139	7,7	8,1	PTFE C104 / NBR	OMK-MR	49018500	-		○
	139	7,7	8,1	95 AU V142	OMK-PU	24341048	-		○
	139	7,8	8,1	PA 4112	HDP 330	49084204	IP		●
	139	7,8	8,1	98 AU 928	SK 300	416520	IP		●
	139,5	7,6	8,1	PTFE B602 / FKM	OMK-E	24356581	-		○
	139,5	7,6	8,1	PTFE B602 / NBR	OMK-E	24356591	-		○
	139,5	7,6	8,1	PTFE GM201 / NBR	OMK-E	24356602	-		○
	140	12	13	94 U801	ODI	FU1399-H0	-	○	
	140	12,2	12,5	95 AU V142	T 18	24269443	IP		●
	140	15	16	94 AU 925	AUN 100	14321 40421197	IP SP		● ●
	140	15	16	94 AU 925	NA 300	21794 40421687	IP SP		● ●
	140	15	16	80 NBR B246	Seal Set 0215	24142958	-		○
	140	16	17	94 U801	ODI	FU1402-H0	-	○	
	140	28,5	28,5	93 AU V167	T 44	24351260	-		○
	143	18,5	20	93 AU V167	T 42	24367996	-		○
	143	19,5	20	80 NBR 878	SK 520	117577	-		○
	143	40,9	40,9	80 NBR 878	SK 320	10752	IP		●
	144	7,3	7,5	19YF / 80 A980	SPG	GS0355-V0	-	○	
	144,5	5,9	6,3	PTFE B602 / FKM	OMK-E	49062075	-		○
	144,5	5,9	6,3	PTFE B602 / NBR	OMK-E	49062076	-		○
	144,5	5,9	6,3	PTFE GM201 / NBR	OMK-E	49062077	-		○
	144,6	5,9	6,3	PTFE GM201 / NBR	OMK-E	24276352	-		○
	144,9	5,9	6,3	PTFE GM201 / NBR	OMK-E	24274576	-		○
	144,9	5,9	6,3	PTFE B602 / NBR	OMK-E	24276008	IP		●
	144,9	5,9	6,3	PTFE B602 / FKM	OMK-E	24345128	-		○
	144,9	5,9	6,3	PTFE GM201 / FKM	OMK-E	24359673	-		○
	145	9	10	94 U801	OSI	FU1404-L0	-	○	
	145	9	10	A505	OUHR	CU2687-Q1	-	○	
	145	9	10	94 U641	OUIS	FU1404-P0	-	○	
	145	9	10	94 U801	OUIS	FU1404-P1	-	○	
	145	10	11	80 NBR 878	NA 150	84528 40421767	IP SP		● ●
145	10	11	94 U801	ODI	FU1405-H0	-	○		
146	6,3	6,5	19YF / 70 A305	SPGO	GS1834-V0	-	○		
147,8	9	9,5	PTFE F56110	FOA	165069	IP		●	
150	7	7,5	31BF / 70 A305	SPGC	GS1081-F0	-	○		
163,6	138,6	12,1	12,5	PTFE GM201	OMK-S	24183662	-		○
165	60,5	20	4	88 NBR 101	T MF	15569	-		○
	135	18	19	90 NBR 109	N 100	17946	-		○
	140	12,1	12,5	PTFE GM201	OMK-S	24237355	-		○
	140	18	19	90 NBR 109	N 100	17855	-		○
	140	18,4	19	PTFE B602	L 27	24361318	-		○
	140	19	20	94 U801	ODI	FU1426-H0	-	○	
	140	20	21	94 U801	ODI	FU2186-H0	-	○	
	143	26,5	26,5	80 NBR B281	L 43	24266980	IP		●
	144	7,7	8,1	PTFE B602 / NBR	OMK-MR	24287221	-		○
	145	15	16	94 AU 925	AUN 100	14340	-		○
145	18,5	20	93 AU V167	T 42	24361344	-		○	

D [mm]	d [mm]	H [mm]	L [mm]	Material	Design	Part No.	PU ¹⁾	US	EU
165	149,9	5,9	6,3	PTFE B602 / NBR	OMK-E	24329373	-		○
	150	10,5	11	31BF / 70 A305	SPGC	GS1080F0	-	○	
	150	15	15,5	80 NBR 878	SK 520	129309	-		○
170	26	20	4	88 NBR 101	T MF	15573 40421332	IP SP		● ●
	120	20	4,8	94 U837	CPI	FC0279-C0	-	○	
	140	15	16	90 NBR 109	N 1	17112	-		○
	140	18	19	90 NBR 109	N 100	17947 40421566	IP SP		● ●
	145	11,7	12,5	PTFE B602	OMK-ES	24339183	-		○
	145	11,7	12,5	PTFE GM201	OMK-ES	526064	-		○
	145	12,1	12,5	PTFE GM201	OMK-S	24090828	-		○
	145	12,1	12,5	PTFE GM201	OMK-S	24261693	-		○
	145	15	16	90 NBR 109	N 1	17117	-		○
	145	19	20	94 U801	ODI	FU1436-H0	-	○	
	145	20	21	94 U801	ODI	FU1437-H0	-	○	
	147	15,5	16	19YF / 80 NBR A980 / PA 12NM	SPGW	GS0688-V5	-	○	
	147	15,5	16	19YF / 85 HNBR G928 / PA 12NM	SPGW	GS0688-V6	-	○	
	148	10,8	11	19YF / 80 A980	SPG	GS0356-V0	-	○	
	149	7,7	8,1	PTFE GM201 / NBR	OMK-MR	24131864	IP		●
	149	7,7	8,1	PTFE B602 / NBR	OMK-MR	24179245	IP		●
	149	7,7	8,1	PTFE GM201 / FKM	OMK-MR	24208639	-		○
	149	7,7	8,1	PTFE B602 / FKM	OMK-MR	24340954	-		○
	149	7,7	8,1	PTFE B602 / FKM	OMK-MR	24348368	-		○
	149	7,8	8,1	PA 4112	HDP 330	49306568	IP		●
	149,5	7,6	8,1	PTFE B602 / FKM	OMK-E	24356582	-		○
	149,5	7,6	8,1	PTFE B602 / NBR	OMK-E	24356592	-		○
	149,5	7,6	8,1	PTFE GM201 / NBR	OMK-E	24356603	-		○
	150	9,8	10	19YF / 70 A305	SPGO	GS1835-V0	-	○	
	150	10	11	90 NBR 109	N 1	17122 40421516	IP SP		● ●
	150	12	13	94 U801	ODI	FU1438-H0	-	○	
	150	12,2	12,5	95 AU V142	T 18	24274946	IP		●
	150	15	16	94 AU 925	AUN 100	14330 40421200	IP SP		● ● ●
	150	15	16	94 AU 925	NA 300	21796 40421688	IP SP		● ●
	150	16	17	94 U801	ODI	FU1440-H0	-	○	
	150	18	19	94 AU 925	AUN 1	103802	-		○
	150	18,5	20	93 AU V167	T 42	24367998	-		○
	154,9	5,9	6,3	PTFE B602 / NBR	OMK-E	24275958	IP		●
154,9	5,9	6,3	PTFE GM201 / NBR	OMK-E	24276276	-		○	
154,9	5,9	6,3	PTFE B602 / FKM	OMK-E	24345129	-		○	
155	9	10	94 U801	OSI	FU1441-L0	-	○		
155	9	10	94 U641	OUIS	FU1441-P0	-	○		
155	9	10	94 U801	OUIS	FU1441-P1	-	○		
155	10	11	94 U801	ODI	FU1442-H0	-	○		
155	10,5	11	31BF / 70 A305	SPGC	GS1082F0	-	○		
157	9	9,5	PTFE F56110	FOA	422332	-		○	
175	20	40		90 NBR 109	TDUOH	9801	-		○
	115	18	4	88 NBR 101	T OF	15576	-		○
	140	20	21	90 NBR 109	N 1	11704	-		○

D [mm]	d [mm]	H [mm]	L [mm]	Material	Design	Part No.	PU ¹⁾	US	EU
	140,5	17	4	88 NBR 101	T OF	15577	-		○
	145	15	16	90 NBR 109	N 1	17116	-		○
	145	18	19	90 NBR 109	N 100	17949	-		○
	154	7,7	8,1	PTFE B602 / NBR	OMK-MR	24246987	-		○
	154	7,7	8,1	PTFE B602 / FKM	OMK-MR	24313231	-		○
	154	8,1	8,1	PTFE C104 / NBR	OMK-MR	49012838	-		○
175	155	18,5	20	93 AU V167	T 42	24366948	-		○
	159,5	5,9	6,3	PTFE B602 / NBR	OMK-MR	24361027	IP		●
	159,9	5,9	6,3	PTFE B602 / NBR	OMK-E	24336437	-		○
	160	9	10	94 U801	OSI	FU1458-L0	-	○	
	160	9	10	94 U801	OUIS	FU1458-P0	-	○	
	160	9	10	94 U641	OUIS	FU1458-P1	-	○	
	160	10,5	11	31BF / 70 A305	SPGC	GS1083-F0	-	○	
176,8	155,8	7,7	8,1	PTFE GM201 / NBR	OMK-MR	24355436	-		○
177	161,9	5,9	6,3	PTFE GM201 / NBR	OMK-E	24248742	-		○
178	157	7,7	8,1	PTFE GM201 / NBR	OMK-MR	24359929	-		○
	80	25	5	80 NBR 104	CPH	CC0285-C0	-	○	
	90	20	5	60 NBR A102	CPH	CC0282-C0	-	○	
	130	15	4	88 NBR 101	T OF	15582	-		○
	130	20	4,8	94 U838	CPI	FC0282-C1	-	○	
	140	20	5	88 NBR 101	T OF	15585	-		○
	150	15	16	94 AU 925	AUN 1	103804	-		○
	150	15	16	90 NBR 109	N 1	17120	-		○
	150	17,2	19	95 AU V142	TM 21	24370478	-		○
	150	18	19	90 NBR 109	N 100	17760 40421542	IP SP		● ●
	150	18	19	80 NBR 878	NA 400	3631	IP		●
	150	18,6	19	95 AU V142	T 18	24245893	IP		●
	150	18,6	19,8	95 AU V142	T 18	24245869	IP		●
	150	30,5	31,5	BHNBR B4B246	EK	24070171	IP		●
	150	30,5	31,5	BHFKM B4K674	EKV	24139365	IP		●
	155	11,7	12,5	PTFE B602	OMK-ES	24298561	-		○
	155	12,1	12,5	PTFE GM201	OMK-S	24083159	IP		●
180	155	12,1	12,5	PTFE B602	OMK-S	24352520	-		○
	155	16	17	94 U801	ODI	FU1475-H0	-	○	
	155	18,4	19	PTFE B602	L 27	24361319	-		○
	155	19	20	94 U801	ODI	FU2171-H0	-	○	
	155	20	21	94 U801	ODI	FU1476-H0	-	○	
	155	25,4	25,4	80 NBR B281	L 43	24380750	-		○
	157	15,5	16	19YF / 80 NBR A980 / PA 12NM	SPGW	GS0616-V5	-	○	
	157	15,5	16	19YF / 85 HNBR G928 / PA 12NM	SPGW	GS0616-V7	-	○	
	158	10,8	11	19YF / 80 A980	SPG	GS0357-V0	-	○	
	158	26,5	26,5	80 NBR B281	L 43	24251791	IP		●
	159	7,7	8,1	PTFE GM201 / NBR	OMK-MR	24131865	IP		●
	159	7,7	8,1	PTFE B602 / NBR	OMK-MR	24179246	IP		●
	159	7,7	8,1	PTFE GM201 / FKM	OMK-MR	24195994	-		○
	159	7,7	8,1	PTFE B602 / FKM	OMK-MR	24288832	IP		●
	159	7,8	8,1	PA 4112	HDP 330	49083054	IP		●
	159	7,8	8,1	98 AU 928	SK 300	417470	IP		●
	159	8,1	8,1	PTFE C104 / NBR	OMK-MR	49000295	-		○

D [mm]	d [mm]	H [mm]	L [mm]	Material	Design	Part No.	PU ¹⁾	US	EU
180	159,5	7,6	8,1	PTFE B602 / FKM	OMK-E	24356583	-		○
	159,5	7,6	8,1	PTFE B602 / NBR	OMK-E	24356593	-		○
	159,5	7,6	8,1	PTFE GM201 / NBR	OMK-E	24356604	-		○
	160	9,8	10	19YF / 70 A305	SPGO	GS1836-V0	-	○	
	160	12	13	94 U801	ODI	FU1478-H0	-	○	
	160	12,2	12,5	95 AU V142	T 18	24287370	IP		●
	160	14	15	90 NBR 109	N 1	17137 40421517	IP SP		● ●
	160	14	15	80 NBR 878	NA 150	84529 40421768	IP SP		● ●
	160	15	16	94 AU 925	AUN 100	14320 40421196	IP SP		● ●
	160	15	16	90 NBR 109	N 100	15937 40421335	IP SP		● ●
	160	15	16	80 NBR 878	NA 250	29462	-		○
	160	15	16	94 AU 925	NA 300	3980	IP		●
	160	16	17	94 U801	ODI	FU1479-H0	-	○	
	163	40,9	40,9	80 NBR 878	SK 320	10753	IP		●
	164,9	5,9	6,3	PTFE GM201 / NBR	OMK-E	24257397	-		○
	164,9	5,9	6,3	PTFE B602 / NBR	OMK-E	24275992	-		○
	164,9	5,9	6,3	PTFE B602 / FKM	OMK-E	24345130	-		○
	165	9	10	94 U801	OSI	FU1481-H0	-	○	
	165	9	10	A505	OUHR	CU2688-Q1	-	○	
	165	9	10	94 U641	OUIS	FU1481-P0	-	○	
165	9	10	94 U801	OUIS	FU1481-P1	-	○		
165	10	11	94 U801	ODI	FU1482-H0	-	○		
165	10,5	11	31BF / 70 A305	SPGC	GS1084-F0	-	○		
167,8	9	9,5	PTFE F56110	FOA	422335	IP		●	
184,1	163,1	7,7	8,1	PTFE GM201 / NBR	OMK-MR	24300807	-		○
	163,1	7,7	8,1	PTFE B602 / NBR	OMK-MR	24300942	-		○
185	155	15	16	90 NBR 109	N 1	17131	-		○
	160	12,1	12,5	PTFE GM201	OMK-S	24237361	-		○
	160	15	16	90 NBR 109	N 1	17138	-		○
	160	19	20	94 U801	ODI	FU2172-H0	-	○	
	160	20	21	94 U801	ODI	FU2187-H0	-	○	
	160	25,4	25,4	80 NBR B281	L 43	24380749	-		○
	162	15,5	16	19YF / 80 NBR A980 / PA 12NM	SPGW	GS0653-V5	-	○	
	162	15,5	16	19YF / 85 HNBR G928 / PA 12NM	SPGW	GS0653-V6	-	○	
	164	7,7	8,1	PTFE B602 / NBR	OMK-MR	24231189	IP		●
	164	7,7	8,1	PTFE GM201 / NBR	OMK-MR	49041837	-		○
	165	14,2	15,5	93 AU V167	T 42	24375902	-		○
	165	15	15,5	80 NBR 878	SK 520	143164	-		○
165	18,5	20	93 AU V167	T 42	24361930	-		○	
170	10,5	11	31BF / 70 A305	SPGC	GS1085-F0	-	○		
185,5	160,5	12,1	12,5	PTFE B602	OMK-S	24349376	-		○
187	162	12,1	12,5	PTFE GM201	OMK-S	24240812	-		○
	166	7,7	8,1	PTFE GM201 / NBR	OMK-MR	24354715	-		○
190	140	20	4,8	94 U839	CPI	FC0289-C0	-	○	
	145	21,5	6,5	88 NBR 101	T OF	15600	-		○
	160	15	16	90 NBR 109	N 1	17135	-		○
160	22	23	90 NBR 109	N 100	17675	-		○	

D [mm]	d [mm]	H [mm]	L [mm]	Material	Design	Part No.	PU ¹⁾	US	EU
	165	12,1	12,5	PTFE GM201	OMK-S	24096111	-		○
	165	12,1	12,5	PTFE B602	OMK-S	24328186	-		○
	165	16	17	94 U801	ODI	FU1507-H0	-	○	
	165	20	21	94 U801	ODI	FU1508-H0	-	○	
	167	15,5	16	19YF / 80 NBR A980 / PA 12NM	SPGW	GS0644-V5	-	○	
	168	10,8	11	19YF / 80 A980	SPG	GS0358-V0	-	○	
	169	7,7	8,1	PTFE GM201 / NBR	OMK-MR	24131866	-		○
	169	7,7	8,1	PTFE B602 / NBR	OMK-MR	24179247	IP		●
	169	7,7	8,1	PTFE B602 / FKM	OMK-MR	24348369	-		○
	169	7,8	8,1	PA 4112	HDP 330	49306571	IP		●
	169,5	7,6	8,1	PTFE B602 / NBR	OMK-E	24356594	-		○
190	169,5	7,6	8,1	PTFE GM201 / NBR	OMK-E	24356605	-		○
	170	9,8	10	19YF / 70 A305	SPGO	GS1837-V0	-	○	
	170	12	13	94 U801	ODI	FU1509-H0	-	○	
	170	16	17	94 U801	ODI	FU1510-H0	-	○	
	174,9	5,9	6,3	PTFE B602 / NBR	OMK-E	24356595	-		○
	174,9	5,9	6,3	PTFE GM201 / NBR	OMK-E	24356606	-		○
	174,9	6,3	6,3	PTFE B602 / FKM	OMK-E	24345131	-		○
	175	9	10	94 U801	OSI	FU1511-H0	-	○	
	175	9	10	94 U641	OUIS	FU1511-P0	-	○	
	175	9	10	94 U801	OUIS	FU1511-P1	-	○	
	175	10	11	94 U801	ODI	FU1512-H0	-	○	
	175	10,5	11	31BF / 70 A305	SPGC	GS1086-F0	-	○	
	177,8	9	9,5	PTFE F56110	FOA	405589	IP		●
	165	15	16	90 NBR 109	N 1	17139	-		○
195	165	26	27	94 AU 925	AUN 1	103810	-		○
	174	7,7	8,1	PTFE GM201 / NBR	OMK-MR	24146929	-		○
	174	7,7	8,1	PTFE B602	OMK-MR	24355438	-		○
	180	10,5	11	31BF / 70 A305	SPGC	GS1087-F0	-	○	
	20	40		90 NBR 109	TUOH	11606	IP		●
	102	30	4	88 NBR 101	T OF	15610	-		○
	130	24	5	88 NBR 101	T OF	15611	-		○
	150	20	4,8	94 U840	CPI	FC0293-C0	-	○	
	150	20	5	90 NBR A505	CPH	CC0293-C5	-	○	
	150	20	5	88 NBR 101	T OF	15608	-		○
	160	15	3,5	88 NBR 101	T MF	15613 40421334	IP SP		● ●
	162	17	3	88 NBR 101	T OF	15607 40421333	IP SP		● ●
200	170	14,5	15	PTFE GM201	OMK-S	24090829	-		○
	170	15	16	90 NBR 109	N 1	17143 40421518	IP SP		● ●
	170	18	19	80 NBR 878	NA 400	25493	-		○
	170	18,6	19	95 AU V142	T 18	24245894	IP		●
	170	18,6	19,8	95 AU V142	T 18	24245870 0521-245.870	IP -	○	●
	170	18,6	20	95 AU V142	T 18	24245895	IP		●
	170	20,9	23	93 AU V167	TMP 21	24370320	-		○
	170	22	23	90 NBR 109	N 100	17721 40421539	IP SP		● ●
	170	22	23	80 NBR B246	Seal Set 0217	24291117	-		○
	170	26	27	94 AU 925	AUN 1	103812	-		○

D [mm]	d [mm]	H [mm]	L [mm]	Material	Design	Part No.	PU ¹⁾	US	EU
200	170	32,5	33,5	BHNBR B4B246	EK	24266531	IP		●
	170	32,5	33,5	BHKM B4K674	EKV	24139359	IP		●
	170	37,5	38,7	BHNBR B4B246	EK	24079621	-		○
	175	11,7	12,5	PTFE GM201	OMK-ES	24380283	-		○
	175	12,1	12,5	PTFE GM201	OMK-S	24096112	IP		●
	175	12,1	12,5	PTFE GM201	OMK-S	24127171	-		○
	175	12,1	12,5	PTFE B602	OMK-S	24374707	-		○
	175	12,1	12,5	PTFE B602	OMK-S	49018526	-		○
	175	15	16	80 NBR 878	NA 400	25491	IP		●
	175	15,7	16	95 AU V142	T 18	24287379	IP		●
	175	16	17	94 U801	ODI	FU1536-H0	-	○	
	175	18,4	19	PTFE B602	L 27	24361320	-		○
	175	18,8	20	80 NBR B246	Seal Set 0215	24142961	-		○
	175	19	20	94 U801	ODI	FU2173-H0	-	○	
	175	20	21	94 U801	ODI	FU1538-H0	-	○	
	175	24	24	93 AU V167	T 44	24368023	-		○
	175	28,5	28,5	93 AU V167	T 44	24368024	-		○
	175	31,5	31,5	80 NBR B281	L 43	24251674	IP		●
	177	15,5	16	19YF / 80 NBR A980 / PA 12NM	SPGW	GS0617-V5	-	○	
	177	15,5	16	19YF / 85 HNBR G928 / PA 12NM	SPGW	GS0617-V7	-	○	
	178	10,8	11	19YF / 80 A980	SPG	GS0359-V0	-	○	
	179	7,6	8,1	PTFE GM201 / NBR	OMK-E	49062084	-		○
	179	7,6	8,1	PTFE B602 / NBR	OMK-E	49062085	-		○
	179	7,6	8,1	PTFE B602 / FKM	OMK-E	49062087	-		○
	179	7,7	8,1	PTFE GM201 / NBR	OMK-MR	24131867	IP		●
	179	7,7	8,1	PTFE B602 / NBR	OMK-MR	24179248	IP		●
	179	7,7	8,1	PTFE GM201 / FKM	OMK-MR	24217740	-		○
	179	7,7	8,1	PTFE B602 / FKM	OMK-MR	24306875	-		○
	179	7,7	8,1	PTFE B602 / NBR	OMK-MR	49008554	-		○
	179	7,7	8,1	95 AU V142	OMK-PU	24341359	-		○
	179	7,8	8,1	PA 4112	HDP 330	49071468	IP		●
	179,5	7,6	8,1	PTFE GM201 / NBR	OMK-E	24239837	-		○
	179,5	7,6	8,1	PTFE B602 / NBR	OMK-E	24276022	-		○
	179,5	7,6	8,1	PTFE B602 / FKM	OMK-E	24346283	-		○
	179,5	7,6	8,1	PTFE B602 / NBR	OMK-E	49008555	-		○
	180	9,8	10	19YF / 70 A305	SPGO	GS1838-V0	-	○	
	180	10	11	90 NBR 109	N 1	17151 40421519	IP SP	○	● ●
	180	12	5,7	A505	OUHR	CU1539-Q1	-	○	
	180	12	13	94 U801	OSI	FU1539-L0	-	○	
	180	12	13	A567	OUHR	CU1539-Q2	-	○	
180	12	13	94 U641	OUIS	FU1539-P0	-	○		
180	12	13	94 U801	OUIS	FU1539-P1	-	○		
180	14	15	80 NBR 878	NA 150	84530 40421769	IP SP		● ●	
180	15	15,5	80 NBR 878	SK 520	145832	-		○	
180	15	16	94 AU 925	AUN 100	103817 40421848	IP SP		● ●	
180	15	16	94 AU 925	NA 300	21811 40421689	- SP	○	● ●	
180	16	17	94 U801	ODI	FU1540-H0	-	○		

D [mm]	d [mm]	H [mm]	L [mm]	Material	Design	Part No.	PU ¹⁾	US	EU
200	180	18	19	94 AU 925	AUN 1	103815	-		○
	180	49,9	49,9	80 NBR 878	SK 320	10766	IP		●
	184,9	5,9	6,3	PTFE GM201 / NBR	OMK-E	24259426	-		○
	185	10,5	11	31BF / 70 A305	SPGC	GS1088-F0	-	○	
203,2	187,8	9	9,5	PTFE F56110	FOA	378166	IP		●
	182,2	7,7	8,1	PTFE B602 / FKM	OMK-MR	24363331	-		○
204	180	12	13	90 NBR 109	N 1	17149	-		○
	182	10,8	11	19YF / 80 A980	SPG	GS0360-V0	-	○	
205	134	23	4	70 NBR A103	CPH	CC0303-C1	-	○	
	175	15	16	90 NBR 109	N 1	17145	-		○
	180	12,1	12,5	PTFE GM201	OMK-S	24263860	-		○
	180	19	20	94 U801	ODI	FU2174-H0	-	○	
	180	20	21	94 U801	ODI	FU2188-H0	-	○	
	184	7,7	8,1	PTFE B602 / NBR	OMK-MR	24259749	-		○
206,5	185,5	7,7	8,1	31BF / 70 A305	SPGC	GS1089-F0	-	○	
207,5	185,5	7,7	8,1	PTFE B602 / NBR	OMK-MR	24342419	-		○
210	170	20	21	PTFE GM201 / NBR	OMK-MR	24231392	-		○
	180	15	16	90 NBR 109	N 1	17142	-		○
	180	20,9	23	90 NBR 109	N 1	17150	-		○
	180	22	23	95 AU V142	TM 21	24370479	-		○
	180	22	23	90 NBR 109	N 100	17708	-	○	○
	185	11,7	12,5	PTFE GM201	OMK-ES	24351170	-		○
	185	12,1	12,5	PTFE GM201	OMK-S	24142938	IP		●
	185	16	17	94 U801	ODI	FU1570-H0	-	○	
	185	20	21	94 U801	ODI	FU1571-H0	-	○	
	187	15,5	16	19YF / 80 NBR A980 / PA 80NP	SPGW	GS0654-V2	-	○	
	187	15,5	16	19YF / 85 HNBR G928 / PA 80NP	SPGW	GS0654-V4	-	○	
	188	10,8	11	19YF / 80 A980	SPG	GS0361-V0	-	○	
	189	7,7	8,1	PTFE GM201 / NBR	OMK-MR	24138658	-		○
	189	7,7	8,1	PTFE B602 / NBR	OMK-MR	24236852	IP		●
	189	7,7	8,1	PTFE B602 / FKM	OMK-MR	24348384	-		○
	189	7,7	8,1	PTFE C104 / NBR	OMK-MR	49036993	-		○
	189,5	7,6	8,1	PTFE B602 / NBR	OMK-E	24275962	IP		●
	189,5	7,6	8,1	PTFE GM201 / NBR	OMK-E	24276280	-		○
	189,5	7,6	8,1	PTFE B602 / FKM	OMK-E	24345133	-		○
	190	9,8	10	19YF / 70 A305	SPGO	GS1839-V0	-	○	
190	12	13	94 U801	OSI	FU1572-L0	-	○		
190	15	15,5	80 NBR 878	SK 520	143158	-		○	
190	15	16	94 AU 925	AUN 100	103821 40421849	IP SP		● ●	
190	16	17	94 U801	ODI	FU1573-H0	-	○		
190	18,5	20	93 AU V167	T 42	24368002	-		○	
195	10,5	11	31BF / 70 A305	SPGC	GS1090-F0	-	○		
212	187	12,1	12,5	PTFE GM201	OMK-S	24245465	-		○
214	193	7,7	8,1	PTFE B602 / NBR	OMK-MR	24378092	-		○
215	20	10,5	11	31BF / 70 A305	SPGC	GS1091-F0	-	○	
	190	12,1	12,5	PTFE GM201	OMK-S	24240809	-		○
	190	16	17	94 U801	ODI	FU2260-H0	-	○	
	193	10,8	11	19YF / 80 A980	SPG	GS0548-V0	-	○	
194	7,7	8,1	PTFE B602 / NBR	OMK-MR	24233505	IP		●	

D [mm]	d [mm]	H [mm]	L [mm]	Material	Design	Part No.	PU ¹⁾	US	EU
215	194	7,7	8,1	PTFE GM201 / NBR	OMK-MR	24380695	-		○
	194	8,1	8,1	PTFE C104 / NBR	OMK-MR	49000267	-		○
	194,5	7,6	8,1	PTFE B602 / NBR	OMK-E	525317	-		○
216	196	28,5	28,5	93 AU V167	T 44	24356551	-		○
216,5	195,5	7,7	8,1	PTFE GM201 / NBR	OMK-MR	24355440	-		○
218	193	12,1	12,5	PTFE GM201	OMK-S	24269666	-		○
220	20	9,8	10	19YF / 70 A305	SPGO	GS1840-V0	-	○	
	20	12	13	94 U801	OSI	FU1594-L0	-	○	
	20	16	17	94 U801	ODI	FU1595-H0	-	○	
	170	20	4	88 NBR 101	T MF	15632	-		○
	180	20	21	94 AU 925	AUN 1	103813	-		○
	190	15	16	90 NBR 109	N 1	17158	-		○
	190	18	19	94 AU 925	NA 300	21816	-		○
	190	18	19	80 NBR 878	NA 400	25495	-		○
	190	20,9	23	95 AU V142	TM 21	24368168	-		○
	190	20,9	23	93 AU V167	TMP 21	24368204	-		○
	190	22	23	90 NBR 109	N 100	17736	-		○
	190	22	23	80 NBR B246	Seal Set 0215	24238654	-		○
	190	22	23	80 NBR B246	Seal Set 0217	24245130	-		○
	190	28,5	24,5	93 AU V167	T 44	24368027	-		○
	190	32,5	33,5	BH-NBR B4B246	EK	24085858	IP		●
	190	37,5	38,7	BH-NBR B4B246	EK	24199656	-		○
	195	12,1	12,5	PTFE GM201	OMK-S	24096113	IP		●
	195	15	16	80 NBR 878	NA 400	4580	-		○
	195	16	17	94 U801	ODI	FU1592-H0	-	○	
	195	20	21	94 U801	ODI	FU1593-H0	-	○	
	195,5	7,7	8,1	PTFE B602 / FKM	OMK-MR	24377428	-		○
	197	15,5	16	19YF / 80 NBR A980 / PA 80NP	SPGW	GS0655-V2	-	○	
	198	10,8	11	19YF / 80 A980	SPG	GS0842-V0	-	○	
	199	7,7	8,1	PTFE GM201 / NBR	OMK-MR	24131868	-		○
	199	7,7	8,1	PTFE B602 / NBR	OMK-MR	24179249	IP		●
	199	7,7	8,1	PTFE B602 / FKM	OMK-MR	24315138	IP		●
	199	7,7	8,1	PTFE C104 / FKM	OMK-MR	49041195	-		○
	199	7,7	8,1	PTFE C104 / NBR	OMK-MR	49045372	-		○
	199	7,8	8,1	PA 4112	HDP 330	49071523	IP		●
	199,5	7,6	8,1	PTFE GM201 / NBR	OMK-E	24208106	-		○
199,5	7,6	8,1	PTFE B602 / NBR	OMK-E	24275994	-		○	
199,5	7,6	8,1	PTFE B602 / FKM	OMK-E	24345134	-		○	
200	15,7	16	95 AU V142	T 18	24337777	IP		●	
200	19,5	20	80 NBR 878	SK 520	150760	-		○	
200	49,9	49,9	80 NBR 878	SK 320	18119	IP		●	
205	10,5	11	31BF / 70 A305	SPGC	GS1092-F0	-	○		
224	180	20	4,8	94 U841	CPI	FC0314-C0	-	○	
	199	16	17	94 U801	ODI	FU1604-H0	-	○	
	199	20	21	94 U801	ODI	FU1605-H0	-	○	
	202	10,8	11	19YF / 80 A980	SPG	GS0362-V0	-	○	
	204	9,8	10	19YF / 70 A305	SPGO	GS1841-V0	-	○	
	204	12	13	94 U801	OSI	FU1606-L0	-	○	
	204	12	13	A505	OUHR	CU3491-Q0	-	○	

D [mm]	d [mm]	H [mm]	L [mm]	Material	Design	Part No.	PU ¹⁾	US	EU
224	204	12	13	94 U641	OUIS	FU1606-P0	-	○	
	204	12	13	94 U801	OUIS	FU1606-P1	-	○	
	204	16	17	94 U801	ODI	FU1607-H0	-	○	
	209	10,5	11	31BF / 70 A305	SPGC	GS1093-F0	-	○	
225	20	16	17	94 U801	ODI	FU1616-H0	-	○	
	20	19	20	94 U801	ODI	FU2175-H0	-	○	
	20	20	21	94 U801	ODI	FU1617-H0	-	○	
	185	20	5	88 NBR 101	T MF	15637	-		○
	195	14,5	15	PTFE GM201	OMK-S	24146980	-		○
	195	15	16	90 NBR 109	N 1	17161	-		○
	195	18,6	19	95 AU V142	T 18	24245871	IP		●
	195	18,6	19,8	95 AU V142	T 18	24245896	IP		●
	195	32,5	33,5	BHNBR B4B246	EK	24266533	IP		●
	195	32,5	33,5	BHFKM B4K674	EKV	24148053	-		○
	195	37,5	38,7	BHNBR B4B246	EK	24075180	-		○
	200	12,1	12,5	PTFE B602	OMK-S	24344249	-		○
	200	12,1	12,5	PTFE GM201	OMK-S	49000416	-		○
	202	15,5	16	19YF / 80 NBR A980 / PA 80NP	SPGW	GS0618-V2	-	○	
	202	15,5	16	19YF / 85 HNBR G928 / PA 80NP	SPGW	GS0618-V8	-	○	
	203	10,8	11	19YF / 80 A980	SPG	GS0363-V0	-	○	
	204	7,7	8,1	PTFE GM201 / NBR	OMK-MR	24137322	-		○
	204	7,7	8,1	PTFE B602 / NBR	OMK-MR	24288833	-		○
	204,5	7,6	8,1	PTFE B602 / NBR	OMK-E	24333690	-		○
	205	12	13	94 U801	OSI	FU1618-H0	-	○	
205	16	17	94 U801	ODI	FU1619-H0	-	○		
205	24	24,5	80 NBR 878	SK 520	309905	-		○	
210	10,5	11	31BF / 70 A305	SPGC	GS1094-F0	-	○		
228,6	196,8	22,2	23,4	80 NBR B246	Seal Set 0217	24245133	-		○
230	30	40		90 NBR 109	TDUOH	11617	-		○
	200	15	16	94 AU 925	AUN 1	103825	-		○
	200	15	16	90 NBR 109	N 1	17166	-		○
	200	20,9	23	95 AU V142	TM 21	24368169	-		○
	200	20,9	23	93 AU V167	TMP 21	24368205	-		○
	200	22	23	90 NBR 109	N 100	17813	-		○
	205	12,1	12,5	PTFE GM201	OMK-S	24224701	-		○
	205	15	16	90 NBR 109	N 1	17172	-		○
	205	16	17	94 U801	ODI	FU1632-H0	-	○	
	205	19	20	94 U801	ODI	FU1633-H0	-	○	
	205	20	21	94 U801	ODI	FU1634-H0	-	○	
	207	15,5	16	19YF / 80 NBR A980 / PA 80NP	SPGW	GS0664-V2	-	○	
	208	10,8	11	19YF / 80 A980	SPG	GS0364-V0	-	○	
	209	7,7	8,1	PTFE GM201 / NBR	OMK-MR	24145853	-		○
	209	7,7	8,1	PTFE B602 / NBR	OMK-MR	24275475	IP		●
	209	7,7	8,1	PTFE B602 / FKM	OMK-MR	24338431	-		○
	209	7,7	8,1	PTFE B602 / FKM	OMK-MR	24348385	-		○
	209	7,7	8,1	PTFE C104 / NBR	OMK-MR	49000268	-		○
	209,5	7,6	8,1	PTFE B602 / NBR	OMK-E	24275964	-		○
	209,5	7,6	8,1	PTFE GM201 / NBR	OMK-E	24276282	IP		●

D [mm]	d [mm]	H [mm]	L [mm]	Material	Design	Part No.	PU ¹⁾	US	EU
230	209,5	7,6	8,1	PTFE B602 / FKM	OMK-E	24345135	-		○
	209,5	7,6	8,1	PTFE GM201 / FKM	OMK-E	24374691	-		○
	210	9,8	10	19YF / 70 A305	SPGO	GS1842-V0	-	○	
	210	12	13	94 U801	OSI	FU1635-L0	-	○	
	210	16	17	94 U801	ODI	FU1636-H0	-	○	
	215	10,5	11	31BF / 70 A305	SPGC	GS1095-F0	-	○	
235	205	18	19	80 NBR B246	Seal Set 0217	24298553	-		○
	210	12,1	12,5	PTFE GM201	OMK-S	24292289	-		○
	210	23,5	23,5	93 AU V167	T 44	24351264	-		○
	214	7,7	8,1	PTFE B602 / NBR	OMK-MR	24315953	-		○
	214	7,7	8,1	PTFE GM201 / NBR	OMK-MR	49036333	-		○
	220	10,5	11	31BF / 70 A305	SPGC	GS1096-F0	-	○	
237	216	7,7	8,1	PTFE B602 / NBR	OMK-MR	24301326	-		○
240	170	20,5	4,5	88 NBR 101	T OF	15642	-		○
	200	20	21	90 NBR 109	N 1	17167	-		○
	210	14,5	15	PTFE GM201	OMK-S	24224707	-		○
	210	20	21	90 NBR 109	N 1	17178	-		○
	210	20,9	23	95 AU V142	TM 21	24368170	-		○
	210	20,9	23	93 AU V167	TMP 21	24368206	-		○
	210	22	23	80 NBR B246	Seal Set 0217	24265118	-		○
	210	32,5	33,5	BH-NBR B4B246	EK	24121200	-		○
	210	37,5	38,7	BH-NBR B4B246	EK	24102695	-		○
	215	12,1	12,5	PTFE GM201	OMK-S	24224705	-		○
	215	12,1	12,5	PTFE B602	OMK-S	24349379	-		○
	215	16	17	94 U801	ODI	FU1652-H0	-	○	
	215	19	20	94 U801	ODI	FU1653-H0	-	○	
	215	20	21	94 U801	ODI	FU1654-H0	-	○	
	217	15,5	16	19YF / 80 NBR A980 / PA 80NP	SPGW	GS0656-V2	-	○	
	218	10,8	11	19YF / 80 A980	SPG	GS0365-V0	-	○	
	219	7,7	8,1	PTFE GM201 / NBR	OMK-MR	24107902	-		○
	219	7,7	8,1	PTFE B602 / NBR	OMK-MR	24191703	IP		●
	219	7,7	8,1	PTFE B602 / FKM	OMK-MR	24348370	-		○
	219,5	7,6	8,1	PTFE B602 / NBR	OMK-E	24276010	-		○
	219,5	7,6	8,1	PTFE GM201 / NBR	OMK-E	24276354	-		○
	219,5	7,6	8,1	PTFE B602 / FKM	OMK-E	24345136	-		○
	220	9,8	10	19YF / 70 A305	SPGO	GS1843-V0	-	○	
220	12	13	94 U801	OSI	FU1655-L0	-	○		
220	16	17	94 U801	ODI	FU1656-H0	-	○		
225	10,5	11	31BF / 70 A305	SPGC	GS1097-F0	-	○		
245	215	14,5	15	PTFE GM201	OMK-S	24214298	-		○
	220	22,5	24	93 AU V167	T 42	24368006	-		○
	224	7,7	8,1	PTFE B602 / NBR	OMK-MR	24287245	-		○
	230	10,5	11	31BF / 70 A305	SPGC	GS1098-F0	-	○	
248,5	227,5	7,7	8,1	PTFE B602 / NBR	OMK-MR	24342420	-		○
250	20	20	4,8	94 U842	CPI	FC0321-C0	-	○	
	210	20	5	88 NBR 101	T OF	15646	-		○
	210	20	21	90 NBR 109	N 1	17177	-		○
	210	34	35	94 AU 925	AUN 1	103831	-		○
	215	20	21	80 NBR 878	NA 400	25503	-	○	○

D [mm]	d [mm]	H [mm]	L [mm]	Material	Design	Part No.	PU ¹⁾	US	EU
	220	14,5	15	PTFE GM201	OMK-S	24096114	IP		●
	220	14,5	15	PTFE B602	OMK-S	24344250	-		○
	220	14,5	15	PTFE B602	OMK-S	529429	-		○
	220	15	16	90 NBR 109	N 1	17188	-		○
	220	18	19	80 NBR 878	NA 400	25496	IP		●
	220	18,6	19	95 AU V142	T 18	24245872	IP		●
	220	18,6	19,8	95 AU V142	T 18	24245897	IP		●
	220	18,6	20	95 AU V142	T 18	24245873	IP		●
	220	20,9	23	95 AU V142	TM 21	24368171	-		○
	220	20,9	23	93 AU V167	TMP 21	24368207	-		○
	220	22	23	80 NBR B246	Seal Set 0215	24299010	-		○
	220	22	23	80 NBR B246	Seal Set 0217	24291116	-		○
	220	24	25	BHNBR B4B246	EK	24248388	-		○
	220	26	27	94 AU 925	AUN 1	103834	-		○
	220	32,5	33,5	BHNBR B4B246	EK	24149616	IP		●
	220	32,5	33,5	BHKM B4K674	EKV	24139363	IP		●
	220	37,5	38,7	BHNBR B4B246	EK	24220077	IP		●
	222	17	17,5	19YF / 80 NBR A980 / PA 80NFP	SPGW	GS0451-V4	-	○	
	225	15,7	16	95 AU V142	T 18	24289374	IP		●
	225	16	17	94 U801	ODI	FU1671-H0	-	○	
	225	18	19	90 NBR 109	N 100	17976	-		○
	225	18,4	19	PTFE B602	L 27	24370692	-		○
	225	18,8	20	80 NBR B246	Seal Set 0215	24142964	-		○
250	225	19	20	94 U801	ODI	FU1672-H0	-	○	
	225	20	21	94 U801	ODI	FU1673-H0	-	○	
	225	23,5	25	93 AU V167	T 42	24368007	-		○
	228	10,8	11	19YF / 80 A980	SPG	GS0366-V0	-	○	
	229	7,6	8,1	PTFE B602 / FKM	OMK-E	49062078	-		○
	229	7,6	8,1	PTFE B602 / NBR	OMK-E	49062079	-		○
	229	7,6	8,1	PTFE GM201 / NBR	OMK-E	49062080	-		○
	229	7,7	8,1	PTFE GM201 / NBR	OMK-MR	24131869	IP		●
	229	7,7	8,1	PTFE B602 / NBR	OMK-MR	24179250	IP		●
	229	7,7	8,1	PTFE GM201 / FKM	OMK-MR	24222889	-		○
	229	7,7	8,1	PTFE B602 / FKM	OMK-MR	24288709	-		○
	229	8,1	8,1	PTFE C104 / NBR	OMK-MR	49000269	-		○
	229,5	7,6	8,1	PTFE GM201 / NBR	OMK-E	24245626	-		○
	229,5	7,6	8,1	PTFE B602 / FKM	OMK-E	24345137	-		○
	229,5	7,7	8,1	PTFE B602 / NBR	OMK-E	24263958	IP		●
	230	9,8	10	19YF / 70 A305	SPGO	GS1844-V0	-	○	
	230	12	13	94 U801	OSI	FU1675-L0	-	○	
	230	12	13	A505	OUHR	CU2691-Q2	-	○	
	230	12	13	A567	OUHR	CU2691-Q3	-	○	
	230	12	13	94 U641	OUIS	FU1675-P0	-	○	
	230	12	13	94 U801	OUIS	FU1675-P1	-	○	
	230	16	17	94 U801	ODI	FU1676-H0	-	○	
	230	25	25,5	80 NBR 878	SK 520	149494	-		○
	230	49,9	49,9	80 NBR 878	SK 320	18120	IP		●
	235	10,5	11	31BF / 70 A305	SPGC	GS1099-F0	-	○	
253	223	14,5	15	PTFE B602	OMK-S	24357149	-		○

D [mm]	d [mm]	H [mm]	L [mm]	Material	Design	Part No.	PU ¹⁾	US	EU
254	233	7,7	8,1	PTFE B602 / NBR	OMK-MR	24343870	-		○
	238,9	5,9	6,3	PTFE B602 / NBR	OMK-E	24331094	-		○
255	225	14,5	15	PTFE B602	OMK-S	24357148	-		○
	225	15	16	90 NBR 109	N 1	17189	-		○
	230	15	16	90 NBR 109	N 1	17196	-		○
	234	7,7	8,1	PTFE B602 / NBR	OMK-MR	24351087	-		○
	240	10,5	11	31BF / 70 A305	SPGC	GS1100F0	-	○	
257	192	22	5,5	70 NBR A103	CPH	CC0328-C1	-	○	
260	230	14	15	PTFE GM201	OMK-ES	24227066	-		○
	230	14	15	PTFE B602	OMK-ES	24378105	-		○
	230	14,5	15	PTFE GM201	OMK-S	24129020	-		○
	230	14,5	15	PTFE B602	OMK-S	24373893	-		○
	230	14,5	15	PTFE B602	OMK-S	49318175	-		○
	230	22	23	90 NBR 109	N 100	17677	-		○
	230	32,5	33,5	BHNBR B4B246	EK	24266547	-		○
	230	37,5	38,7	BHNBR B4B246	EK	24266548	-		○
	232	17	17,5	19YF / 80 NBR A980 / PA 80NP	SPGW	GS0605-V2	-	○	
	235	16	17	94 U801	ODI	FU1698-H0	-	○	
	235	19	20	94 U801	ODI	FU1699-H0	-	○	
	235	23,9	25,4	93 AU V167	T 42	24373958	-		○
	236	7,6	8,1	PTFE B602 / NBR	OMK-E	24275996	-		○
	236	7,6	8,1	PTFE GM201 / NBR	OMK-E	24276340	-		○
	236	7,6	8,1	PTFE B602 / FKM	OMK-E	24345138	-		○
	236	11,7	12	19YF / 80 A980	SPG	GS0700-V0	-	○	
	239	7,7	8,1	PTFE B602 / NBR	OMK-MR	24192188	IP		●
	239	7,7	8,1	PTFE GM201 / NBR	OMK-MR	24223625	-		○
	239	7,7	8,1	PTFE B602 / FKM	OMK-MR	24348386	-		○
	240	9,8	10	19YF / 70 A305	SPGO	GS1845-V0	-	○	
240	12	13	94 U801	OSI	FU1700-L0	-	○		
240	16	17	94 U801	ODI	FU1701-H0	-	○		
245	10,5	11	31BF / 70 A305	SPGC	GS1101-F0	-	○		
265	235	14,5	15	PTFE B602	OMK-S	24361983	-		○
	244	7,7	8,1	PTFE B602 / NBR	OMK-MR	532184	-		○
	250	10,5	11	31BF / 70 A305	SPGC	GS1102-F0	-	○	
268	247	7,7	8,1	PTFE GM201 / NBR	OMK-MR	24380696	-		○
	247	8,1	8,1	PTFE C104 / NBR	OMK-MR	49000270	-		○
270	180	22	5	88 NBR 101	T MF	15672	-		○
	230	20	21	90 NBR 109	N 1	17194	-		○
	240	14,5	15	PTFE GM201	OMK-S	24214997	-		○
	240	20,9	23	93 AU V167	TMP 21	24368317	-		○
	240	22	23	80 NBR B246	Seal Set 0215	24244485	-		○
	240	22	23	80 NBR B246	Seal Set 0217	24245131	-		○
	242	17	17,5	19YF / 80 NBR A980 / PA 80NP	SPGW	GS0689-V2	-	○	
	245	16	17	94 U801	ODI	FU1715-H0	-	○	
	245	19	20	94 U801	ODI	FU1716-H0	-	○	
	245	22,5	24	93 AU V167	T 42	24373583	-		○
	246	7,6	8,1	PTFE B602 / NBR	OMK-E	24275968	-		○
	246	7,6	8,1	PTFE GM201 / NBR	OMK-E	24276286	-		○
246	7,6	8,1	PTFE B602 / FKM	OMK-E	24345139	-		○	

D [mm]	d [mm]	H [mm]	L [mm]	Material	Design	Part No.	PU ¹⁾	US	EU
270	246	11,7	12	19YF / 80 A980	SPG	GS0701-V0	-	○	
	249	7,7	8,1	PTFE GM201 / NBR	OMK-MR	24121481	-		○
	249	7,7	8,1	PTFE B602 / NBR	OMK-MR	24191949	-		○
	249	7,7	8,1	PTFE B602 / FKM	OMK-MR	24258180	-		○
	249	8,1	8,1	PTFE GM201 / FKM	OMK-MR	49019618	-		○
	250	9,8	10	19YF / 70 A305	SPGO	GS1846-V0	-	○	
	250	12	13	94 U801	OSI	FU1717-L0	-	○	
	250	16	17	94 U801	ODI	FU1718-H0	-	○	
272	240	16	17	90 NBR 109	N 1	17197	-		○
	240	26	27	94 AU 925	AUN 1	103838	-		○
275	235	20	21	90 NBR 109	N 1	15909	-		○
	245	14,5	15	PTFE GM201	OMK-S	24224541	-		○
	245	14,5	15	PTFE B602	OMK-S	24269621	-		○
	250	19	20	94 U801	ODI	FU2176-H0	-	○	
	250	20	21	94 U801	ODI	FU2189-H0	-	○	
	251	7,6	8,1	PTFE B602 / NBR	OMK-E	24333793	-		○
	254	7,7	8,1	PTFE B602 / NBR	OMK-MR	24260962	-		○
	254	7,7	8,1	PTFE GM201 / NBR	OMK-MR	24328791	-		○
280	260	10,5	11	31BF / 70 A305	SPGC	GS1104-F0	-	○	
	230	20	4,8	94 U843	CPI	FC0337-C0	-	○	
	240	20	21	90 NBR 109	N 1	11895	-		○
	250	14	15	PTFE GM201	OMK-ES	24265687	-		○
	250	14	15	PTFE B602	OMK-ES	24339180	-		○
	250	14,5	15	PTFE GM201	OMK-S	24075829	IP		●
	250	14,5	15	PTFE B602	OMK-S	24333120	-		○
	250	14,5	15	PTFE GM201	OMK-S	49002652	-		○
	250	14,5	15	PTFE B602	OMK-S	527108	-		○
	250	18	19	80 NBR 878	NA 400	4610	-	○	○
	250	18,6	19	95 AU V142	T 18	24245898	IP		●
	250	18,6	19,8	95 AU V142	T 18	24245874	IP		●
	250	19	20	94 U801	ODI	FU1729-H0	-	○	
	250	20,9	23	95 AU V142	TM 21	24367971	-		○
	250	20,9	23	93 AU V167	TMP 21	24368209	-		○
	250	25	26	90 NBR 109	N 1	18096	-		○
	250	26	27	94 AU 925	AUN 1	103840	-		○
	250	30	31	BHFKM B4K674	EKV	24182616	IP		●
	250	32,5	33,5	BHNBR B4B246	EK	24266549	IP		●
	250	37,5	38,7	BHNBR B4B246	EK	24063522	-		○
	252	17	17,5	19YF / 80 NBR A980 / PA 80NP	SPGW	GS0619-V2	-	○	
	255	16	17	94 U801	OSI	FU1730-L0	-	○	
	255	18,4	19	PTFE B602	L 27	24370693	-		○
	255	19	20	94 U801	ODI	FU1731-H0	-	○	
	255	24,3	24,8	80 NBR 878	SK 520	122825	IP		●
	256	7,6	8,1	PTFE GM201 / NBR	OMK-E	24267603	-		○
	256	7,6	8,1	PTFE B602 / NBR	OMK-E	24276018	-		○
	256	7,6	8,1	PTFE B602 / FKM	OMK-E	24343298	-		○
256	11,7	12	19YF / 80 A980	SPG	GS0702-V0	-	○		
259	7,7	8,1	PTFE GM201 / NBR	OMK-MR	24120265	IP		●	

D [mm]	d [mm]	H [mm]	L [mm]	Material	Design	Part No.	PU ¹⁾	US	EU
280	259	7,7	8,1	PTFE B602 / NBR	OMK-MR	24179251	IP		●
	259	7,7	8,1	PTFE GM201 / FKM	OMK-MR	24238941	-		○
	259	7,7	8,1	PTFE B602 / FKM	OMK-MR	24340952	-		○
	259	7,7	8,1	PTFE C104 / FKM	OMK-MR	49024395	-		○
	259	7,7	8,1	PTFE C104 / NBR	OMK-MR	49035216	IP		●
	259,5	7,6	8,1	PTFE B602 / NBR	OMK-E	49002201	-		○
	260	9,8	10	19YF / 70 A305	SPGO	GS1847-V0	-	○	
	265	10,5	11	31BF / 70 A305	SPGC	GS1105-F0	-	○	
282	252	14,5	15	PTFE GM201	OMK-S	24240814	-		○
285	255	14,5	15	PTFE GM201	OMK-S	24215698	-		○
	260	12	13	90 NBR 109	N 1	11896	-		○
	270	10,5	11	31BF / 70 A305	SPGC	GS1106-F0	-	○	
290	260	14,5	15	PTFE GM201	OMK-S	24224702	-		○
	260	19	20	94 U801	ODI	FU1744-H0	-	○	
	265	16	17	94 U801	OSI	FU1745-L0	-	○	
	265	19	20	94 U801	ODI	FU1746-H0	-	○	
	266	7,6	8,1	PTFE B602 / NBR	OMK-E	24275970	-		○
	266	7,6	8,1	PTFE GM201 / NBR	OMK-E	24276288	-		○
	266	7,6	8,1	PTFE B602 / FKM	OMK-E	24345141	-		○
	266	11,7	12	19YF / 80 A980	SPG	GS0703-V0	-	○	
	269	7,7	8,1	PTFE B602 / NBR	OMK-MR	24275526	-		○
	269	7,7	8,1	PTFE GM201 / NBR	OMK-MR	24275640	-		○
	269	7,7	8,1	PTFE B602 / FKM	OMK-MR	24348372	-		○
	270	9,8	10	19YF / 70 A305	SPGO	GS1848-V0	-	○	
275	10,5	11	31BF / 70 A305	SPGC	GS1107-F0	-	○		
295	271	7,6	8,1	PTFE B602 / FKM	OMK-E	24350075	-		○
	274	7,7	8,1	PTFE B602 / NBR	OMK-MR	24368366	-		○
	280	10,5	11	31BF / 70 A305	SPGC	GS1108-F0	-	○	
297	265	24	25	94 U801	ODI	FU2177-H0	-	○	
	265	25	26	94 U801	ODI	FU2190-H0	-	○	
300	60	40		88 NBR 101	TDUOH	9811	IP		●
	250	20	4,8	94 U844	CPI	FC0344-C1	-	○	
	260	20	21	90 NBR 109	N 1	17203	-		○
	270	14	15	PTFE GM201	OMK-ES	24209307	-		○
	270	14	15	PTFE B602	OMK-ES	24339181	IP		●
	270	14,5	15	PTFE GM201	OMK-S	24064404	IP		●
	270	14,5	15	PTFE GM201	OMK-S	24222592	-		○
	270	14,5	15	PTFE B602	OMK-S	24374282	-		○
	270	14,5	15	PTFE B602	OMK-S	525547	-		○
	270	18,6	19	95 AU V142	T 18	24245899	IP		●
	270	18,6	19,8	95 AU V142	T 18	24245875	IP		●
	270	19	20	94 U801	ODI	FU1758-H0	-	○	
	270	19	20	80 NBR B246	Seal Set 0215	24265068	-		○
	270	20,9	23	95 AU V142	TM 21	24368173	-		○
	270	20,9	23	93 AU V167	TMP 21	24372471	-		○
	270	22	23	90 NBR 109	N 100	18078	-		○
	270	22	23	80 NBR B246	Seal Set 0217	24292037	-		○
	270	24	25	94 U801	ODI	FU2178-H0	-	○	
	270	25	26	94 U801	ODI	FU1759-H0	-	○	
	270	32,5	33,5	BHNBR B4B246	EK	24266550	IP		●

D [mm]	d [mm]	H [mm]	L [mm]	Material	Design	Part No.	PU ¹⁾	US	EU
	270	32,5	33,5	BHFKM B4K674	EKV	24148055	-		○
	270	37,5	38,7	BHNBR B4B246	EK	24063954	IP		●
	272	17	17,5	19YF / 80 NBR A980 / PA 80NP	SPGW	GS0510-V2	-	○	
	275	16	17	94 U801	OSI	FU1760L0	-	○	
	275	18,4	19	PTFE B602	L 27	24370694	-		○
	275	19	20	94 U801	ODI	FU1761-H0	-	○	
	276	7,6	8,1	PTFE B602 / NBR	OMK-E	24275998	IP		●
	276	7,6	8,1	PTFE GM201 / NBR	OMK-E	24276342	-		○
300	276	7,6	8,1	PTFE B602 / FKM	OMK-E	24345142	-		○
	276	7,6	8,1	PTFE B602 / FKM	OMK-E	24354841	-		○
	276	11,7	12	19YF / 80 A980	SPG	GS0704-V0	-	○	
	279	7,7	8,1	PTFE GM201 / NBR	OMK-MR	24179922	-		○
	279	7,7	8,1	PTFE B602 / NBR	OMK-MR	24213824	IP		●
	279	7,7	8,1	PTFE B602 / FKM	OMK-MR	24266419	-		○
	279	8,1	8,1	PTFE C104 / NBR	OMK-MR	49009207	-		○
	280	9,8	10	19YF / 70 A305	SPGO	GS1849-V0	-	○	
	285	10,5	11	31BF / 70 A305	SPGC	GS1109-F0	-	○	
	275	14,5	15	PTFE GM201	OMK-S	24199259	-		○
305	281	7,6	8,1	PTFE B602 / NBR	OMK-E	24350594	-		○
	281	7,6	8,1	PTFE GM201 / NBR	OMK-E	24358722	-		○
	284	7,7	8,1	PTFE B602 / NBR	OMK-MR	24287583	-		○
	290	10,5	11	31BF / 70 A305	SPGC	GS1110-F0	-	○	
308	284	7,6	8,1	PTFE B602 / NBR	OMK-E	24341003	-		○
	280	14,5	15	PTFE GM201	OMK-S	24136342	IP		●
	280	15	16	90 NBR 109	N 1	17209 40421520	IP SP		● ●
	280	20,9	23	95 AU V142	TM 21	24368174	-		○
	280	20,9	23	93 AU V167	TMP 21	24368210	-		○
	280	22	22,3	80 NBR B246	Seal Set 0215	24240365	-		○
	280	22	23	80 NBR B246	Seal Set 0217	24245128	-		○
	280	32,5	33,5	BH-NBR B4B246	EK	24266551	-		○
	280	37,5	38,7	BHNBR B4B246	EK	24106772	-		○
310	286	7,6	8,1	PTFE B602 / NBR	OMK-E	24275972	IP		●
	286	7,6	8,1	PTFE GM201 / NBR	OMK-E	24276290	-		○
	286	7,6	8,1	PTFE B602 / FKM	OMK-E	24345143	-		○
	286	11,7	12	19YF / 80 A980	SPG	GS0705-V0	-	○	
	289	7,7	8,1	PTFE GM201 / NBR	OMK-MR	24248946	-		○
	289	7,7	8,1	PTFE B602 / NBR	OMK-MR	24251064	IP		●
	289	7,7	8,1	PTFE B602 / FKM	OMK-MR	24348840	-		○
	289	7,7	8,1	PTFE GM201 / FKM	OMK-MR	24374543	-		○
	289	7,7	8,1	PTFE C104 / NBR	OMK-MR	533523	-		○
	290	9,8	10	19YF / 70 A305	SPGO	GS1850-V0	-	○	
	295	10,5	11	31BF / 70 A305	SPGC	GS1111-F0	-	○	
312	280	24	25	94 U801	ODI	FU2193-H0	-	○	
	288	7,6	8,1	PTFE B602 / NBR	OMK-E	49005933	-		○
	30	10,5	11	31BF / 70 A305	SPGC	GS1112-F0	-	○	
315	270	25	5	88 NBR 101	T OF	15701	-		○
	291	7,6	8,1	PTFE B602 / FKM	OMK-E	24369048	-		○
	294	7,7	8,1	PTFE B602 / NBR	OMK-MR	24337374	-		○
316,2	286,2	14,5	15	PTFE GM201	OMK-S	24237799	-		○

D [mm]	d [mm]	H [mm]	L [mm]	Material	Design	Part No.	PU ¹⁾	US	EU
320	30	9,8	10	19YF / 70 A305	SPGO	GS1851-V0	-	○	
	240	25	5	88 NBR 101	T OF	15703	-		○
	280	20	21	90 NBR 109	N 1	17208	-		○
	280	23	24	80 NBR 878	NA 400	4624	-		○
	280	29,1	32	95 AU V142	TM 21	24373867	-		○
	280	40	41,5	BHNBR B4B246	EK	24068630	-		○
	280	50	51,8	BHNBR B4B246	EK	24072341	-		○
	285	20	21	80 NBR 878	NA 400	4618	-		○
	290	14	15	PTFE GM201	OMK-ES	24265690	-		○
	290	14	15	PTFE B602	OMK-ES	24339182	-		○
	290	14,5	15	PTFE GM201	OMK-S	24096115	-		○
	290	14,5	15	PTFE B602	OMK-S	24333122	-		○
	290	14,5	15	PTFE GM201	OMK-S	49002653	-		○
	290	14,5	15	PTFE C104	OMK-S	49037709	-		○
	290	14,5	15	PTFE B602	OMK-S	529431	-		○
	290	18,6	20	95 AU V142	T 18	24245900	IP		●
	290	23,5	25	80 NBR B246	Seal Set 0215	24142967	-		○
	290	23,5	25	80 NBR B246	Seal Set 0217	24245126	-		○
	290	28,5	30	93 AU V167	T 42	24368009	-		○
	290	32,5	33,5	BHNBR B4B246	EK	24266552	IP		●
	290	37,5	38,7	BHNBR B4B246	EK	24220080	-		○
	292	17	17,5	19YF / 80 NBR A980 / PA 80NP	SPGW	GS0690-V2	-	○	
	295	18,4	19	PTFE B602	L 27	24370695	-		○
	295,5	7,6	8,1	PTFE B602 / FKM	OMK-E	49062088	-		○
	295,5	7,6	8,1	PTFE B602 / NBR	OMK-E	49062089	-		○
	295,5	7,6	8,1	PTFE GM201 / NBR	OMK-E	49062091	-		○
	296	7,6	8,1	PTFE B602 / NBR	OMK-E	24276012	-		○
	296	7,6	8,1	PTFE GM201 / NBR	OMK-E	24276356	-		○
	296	7,6	8,1	PTFE B602 / FKM	OMK-E	24345144	-		○
	296	11,7	12	19YF / 80 A980	SPG	GS0706-V0	-	○	
	299	7,7	8,1	PTFE GM201 / NBR	OMK-MR	24131870	-		○
	299	7,7	8,1	PTFE B602 / NBR	OMK-MR	24179252	IP		●
299	7,7	8,1	PTFE B602 / FKM	OMK-MR	24288835	-		○	
300	25	25,5	80 NBR 878	SK 520	122735	-		○	
325	295	14,5	15	PTFE GM201	OMK-S	24250595	-		○
	304	7,7	8,1	PTFE B602 / NBR	OMK-MR	24302264	-		○
	304	7,7	8,1	PTFE B602 / FKM	OMK-MR	49007306	-		○
327,5	297,5	14,5	15	PTFE B602	OMK-S	24349382	IP		●
330	285	34	35	94 AU 925	AUN 1	103847	-		○
	290	20	21	90 NBR 109	N 1	17211	-		○
	300	14	15	PTFE B602	OMK-ES	24339186	-		○
	300	14,5	15	PTFE GM201	OMK-S	24137235	-		○
	300	14,5	15	PTFE B602	OMK-S	24296867	-		○
	300	16	17	90 NBR 109	N 1	17214	-		○
	300	20,9	23	95 AU V142	TM 21	24368175	-		○
	300	22	23	90 NBR 109	N 100	17434	-	○	○
	300	22	23	80 NBR B246	Seal Set 0215	24238760	-		○
	300	22	23	80 NBR B246	Seal Set 0217	24245134	-		○
	305,5	7,7	8,1	PTFE GM201 / NBR	OMK-MR	24105259	IP		●

D [mm]	d [mm]	H [mm]	L [mm]	Material	Design	Part No.	PU ¹⁾	US	EU
330	305,5	7,7	8,1	PTFE B602 / NBR	OMK-MR	24275529	-		○
	305,5	7,7	8,1	PTFE B602 / FKM	OMK-MR	24348373	-		○
	306	7,6	8,1	PTFE B602 / NBR	OMK-E	24275974	IP		●
	306	7,6	8,1	PTFE GM201 / NBR	OMK-E	24276292	-		○
	306	7,6	8,1	PTFE B602 / FKM	OMK-E	24345145	-		○
	308	9,75	10	19YF / 80 A980	SPG	GS0408-V0	-	○	
	315	10,5	11	31BF / 70 A305	SPGC	GS1113-F0	-	○	
330,2	305,7	7,7	8,1	PTFE B602 / FKM	OMK-MR	24363330	-		○
332	30	24	25	94 U801	ODI	FU2194-H0	-	○	
335	300	17	17,5	PTFE GM201	OMK-S	24090832	-		○
	305	14,5	15	PTFE GM201	OMK-S	24235222	-		○
	310,5	7,7	8,1	PTFE B602 / NBR	OMK-MR	49019514	-		○
	320	10,5	11	31BF / 70 A305	SPGC	GS1114-F0	-	○	
340	300	20	21	90 NBR 109	N 100	17216	-	○	○
	300	40	41,5	BI-NBR B4B246	EK	24089867	IP		●
	300	50	51,8	BI-NBR B4B246	EK	24067213	-		○
	310	14	15	PTFE B602	OMK-ES	24353070	-		○
	310	14,5	15	PTFE GM201	OMK-S	24075894	IP		●
	310	14,5	15	PTFE B602	OMK-S	24378518	-		○
	310	20,9	23	95 AU V142	TM 21	529099	-		○
	310	22	23	80 NBR B246	Seal Set 0215	24301449	-		○
	310	22	23	80 NBR B246	Seal Set 0217	24301448	-		○
	310	32,5	33,5	BI-NBR B4B246	EK	24266553	-		○
	310	37,5	38,7	BI-NBR B4B246	EK	24067366	-		○
	315,5	7,7	8,1	PTFE GM201 / NBR	OMK-MR	24213529	-		○
	315,5	7,7	8,1	PTFE B602 / NBR	OMK-MR	24213827	IP		●
	315,5	7,7	8,1	PTFE B602 / FKM	OMK-MR	24348374	IP		●
	316	7,6	8,1	PTFE B602 / NBR	OMK-E	24275924	IP		●
	316	7,6	8,1	PTFE GM201 / NBR	OMK-E	24276246	-		○
	316	7,6	8,1	PTFE B602 / FKM	OMK-E	24345146	-		○
320	9,8	10	19YF / 70 A305	SPGO	GS1852-V0	-	○		
345	315	28	28,5	93 AU V167	T 44	24359635	-		○
	315	28,5	30	93 AU V167	T 42	24373956	-		○
	320,5	7,7	8,1	PTFE B602 / NBR	OMK-MR	24348869	-		○
	321	7,6	8,1	PTFE GM201 / NBR	OMK-E	24358725	-		○
	321	7,6	8,1	PTFE GM201 / FKM	OMK-E	24374008	-		○
350	300	25	5	88 NBR 101	T OF	15720	-		○
	310	20	21	90 NBR 109	N 1	17219 5617219	IP		●
	310	40	41,5	BI-NBR B4B246	EK	24266554	-	○	○
	310	50	51,8	BI-NBR B4B246	EK	24266555	-		○
	320	14	15	PTFE GM201	OMK-ES	24248305	-		○
	320	14,5	15	PTFE GM201	OMK-S	24141407	-		○
	320	14,5	15	PTFE B602	OMK-S	24362218	-		○
	320	14,5	15	PTFE GM201	OMK-S	530934	-		○
	320	16	17	94 AU 925	AUN 100	103853	-		○
	320	20,9	23	95 AU V142	TM 21	24370480	-		○
	320	20,9	23	93 AU V167	TMP 21	24368212	-		○
	320	22	23	90 NBR 109	N 100	17734	-		○
	320	22	23	80 NBR B246	Seal Set 0215	24265069	-		○

D [mm]	d [mm]	H [mm]	L [mm]	Material	Design	Part No.	PU ¹⁾	US	EU
350	320	22	23	80 NBR B246	Seal Set 0215	24334236	-		○
	320	22	23	80 NBR B246	Seal Set 0217	24269895	-		○
	325,5	7,7	8,1	PTFE GM201 / NBR	OMK-MR	24199746	-		○
	325,5	7,7	8,1	PTFE B602 / NBR	OMK-MR	24275527	IP		●
	325,5	7,7	8,1	PTFE B602 / FKM	OMK-MR	24328250	-		○
	325,5	7,7	8,1	PTFE B602 / FKM	OMK-MR	24348387	-		○
	325,5	7,7	8,1	PTFE C104 / NBR	OMK-MR	49023944	IP		●
	326	7,6	8,1	PTFE B602 / NBR	OMK-E	24275918	-		○
	326	7,6	8,1	PTFE GM201 / NBR	OMK-E	24276240	-		○
	326	7,6	8,1	PTFE B602 / FKM	OMK-E	24345147	-		○
	330	9,8	10	19YF / 70 A305	SPGO	GS1853-V0	-	○	
	335	10,5	11	31BF / 70 A305	SPGC	GS1115-F0	-	○	
355	325	14,5	15	PTFE GM201	OMK-S	24214995	-		○
	330,5	7,7	8,1	PTFE B602 / NBR	OMK-MR	24330845	-		○
	340	10,5	11	31BF / 70 A305	SPGC	GS1116-F0	-	○	
355,6	325,6	14,5	15	PTFE B602	OMK-S	49035302	-		○
360	320	28	29	94 AU 925	NA 300	21843	-		○
	320	40	41,5	BH-NBR B4B246	EK	24073186	IP		●
	320	50	51,8	BH-NBR B4B246	EK	24068309	IP		●
	330	14,5	15	PTFE GM201	OMK-S	24096116	IP		●
	330	14,5	15	PTFE B602	OMK-S	24371159	-		○
	330	14,5	15	PTFE B602	OMK-S	529432	-		○
	330	20	21	94 AU 925	NA 300	21845	-		○
	330	20,9	23	93 AU V167	TMP 21	24377184	-		○
	330	23,7	26	95 AU V142	TM 21	24370481	-		○
	330	25	26	80 NBR B246	Seal Set 0215	24308767	-		○
	330	25	26	80 NBR B246	Seal Set 0217	24290774	-		○
	330	29,5	31,5	93 AU V167	T 42	24373582	-		○
	335,5	7,7	8,1	PTFE GM201 / NBR	OMK-MR	24118300	-		○
	335,5	7,7	8,1	PTFE B602 / NBR	OMK-MR	24179253	IP		●
	335,5	7,7	8,1	PTFE B602 / FKM	OMK-MR	24333319	-		○
	336	7,6	8,1	PTFE GM201 / NBR	OMK-E	24242310	-		○
	336	7,6	8,1	PTFE B602 / NBR	OMK-E	24275927	-		○
	336	7,6	8,1	PTFE B602 / FKM	OMK-E	24345148	-		○
336	11,7	12	19YF / 80 A980	SPG	GS0917-V0	-	○		
340	9,8	10	19YF / 70 A305	SPGO	GS1854-V0	-	○		
370	330	28	29,5	80 NBR B246	Seal Set 0215	24297841	-		○
	340	14,5	15	PTFE GM201	OMK-S	24193346	-		○
	345,5	7,7	8,1	PTFE B602 / NBR	OMK-MR	24251062	IP		●
	345,5	7,7	8,1	PTFE GM201 / NBR	OMK-MR	24275649	-		○
	345,5	7,7	8,1	PTFE B602 / FKM	OMK-MR	24348375	-		○
	346	7,6	8,1	PTFE B602 / NBR	OMK-E	24275919	-		○
	346	7,6	8,1	PTFE GM201 / NBR	OMK-E	24276241	-		○
	346	7,6	8,1	PTFE B602 / FKM	OMK-E	24345149	-		○
	355	10,5	11	31BF / 70 A305	SPGC	GS1117-F0	-	○	
375	350,5	7,7	8,1	PTFE GM201 / NBR	OMK-MR	24293150	-		○
	350,5	7,7	8,1	PTFE B602 / NBR	OMK-MR	24342373	-		○
	355	9,8	10	19YF / 70 A305	SPGO	GS1855-V0	-	○	
	360	10,5	11	31BF / 70 A305	SPGC	GS1118-F0	-	○	
380	340	40	41,5	BH-NBR B4B246	EK	24063739	IP		●

D [mm]	d [mm]	H [mm]	L [mm]	Material	Design	Part No.	PU ¹⁾	US	EU
	340	50	51,8	BHNBR B4B246	EK	24063609	-		○
	350	14	15	PTFE GM201	OMK-ES	526957	-		○
	350	14,5	15	PTFE GM201	OMK-S	24129082	-		○
	350	14,5	15	PTFE B602	OMK-S	24333123	-		○
	350	23,7	26	95 AU V142	TM 21	24363187	-		○
	350	23,7	26	93 AU V167	TMP 21	24368213	-		○
	350	25	26	80 NBR B246	Seal Set 0215	24240361	-		○
	350	25	26	80 NBR B246	Seal Set 0217	24245490	-		○
380	350	30	32	93 AU V167	T 42	24375290	-		○
	355,5	7,7	8,1	PTFE GM201 / NBR	OMK-MR	24194142	-		○
	355,5	7,7	8,1	PTFE B602 / NBR	OMK-MR	24275530	IP		●
	355,5	7,7	8,1	PTFE GM201 / FKM	OMK-MR	24300634	-		○
	355,5	7,7	8,1	PTFE B602 / FKM	OMK-MR	24311133	-		○
	356	7,6	8,1	PTFE B602 / NBR	OMK-E	24275920	-		○
	356	7,6	8,1	PTFE GM201 / NBR	OMK-E	24276242	-		○
	356	7,6	8,1	PTFE B602 / FKM	OMK-E	24345150	-		○
	360	9,8	10	19YF / 70 A305	SPGO	GS1856-V0	-	○	
382	358	7,6	8,1	PTFE GM201 / NBR	OMK-E	24358724	-		○
382,6	352,6	14,5	15	PTFE GM201	OMK-S	24226330	-		○
385	360,5	7,7	8,1	PTFE B602 / NBR	OMK-MR	24361089	-		○
	360,5	7,7	8,1	PTFE C104 / NBR	OMK-MR	49026723	-		○
386,5	362,5	7,6	8,1	PTFE GM201 / FKM	OMK-E	24374013	-		○
	350	35	36	90 NBR 109	N 1	17226	-		○
	350	40	41,5	BHNBR B4B246	EK	24096917	-		○
	350	50	51,8	BHNBR B4B246	EK	24091905	-		○
	360	14,5	15	PTFE GM201	OMK-S	24175268	IP		●
	360	14,5	15	PTFE GM201	OMK-S	24258069	-		○
	360	14,5	15	PTFE B602	OMK-S	24338621	-		○
390	360	22	23	94 AU 925	AUN 100	103854	-		○
	365,5	7,7	8,1	PTFE GM201 / NBR	OMK-MR	24145902	IP		●
	365,5	7,7	8,1	PTFE B602 / NBR	OMK-MR	24275528	-		○
	365,5	7,7	8,1	PTFE B602 / FKM	OMK-MR	24348309	IP		●
	366	7,6	8,1	PTFE B602 / NBR	OMK-E	24275922	-		○
	366	7,6	8,1	PTFE GM201 / NBR	OMK-E	24276244	-		○
	366	7,6	8,1	PTFE B602 / FKM	OMK-E	24345151	-		○
	375	10,5	11	31BF / 70 A305	SPGC	GS1119F0	-	○	
395	370,5	7,7	8,1	PTFE C104 / NBR	OMK-MR	49023945	IP		●
	370,5	8,1	8,1	PTFE B602 / NBR	OMK-MR	49020721	-		○
	354	25	4	88 NBR 101	T MF	15736	-		○
	360	20	21	90 NBR 109	N 1	17228	-		○
	360	28	29	94 AU 925	NA 300	21846	-		○
	360	29,1	32	95 AU V142	TM 21	24368177	-		○
	360	30,5	32	80 NBR B246	Seal Set 0215	24142970	-		○
	360	30,5	32	80 NBR B246	Seal Set 0217	24245491	-		○
400	360	40	41,5	BHNBR B4B246	EK	24061431	IP		●
	360	50	51,8	BHNBR B4B246	EK	24062353	IP		●
	370	14,5	15	PTFE GM201	OMK-S	24096117	IP		●
	370	14,5	15	PTFE B602	OMK-S	24301151	-		○
	370	14,5	15	PTFE C104	OMK-S	49037710	-		○
	370	20	21	94 AU 925	NA 300	21847	-		○

D [mm]	d [mm]	H [mm]	L [mm]	Material	Design	Part No.	PU ¹⁾	US	EU
	370	23,7	26	95 AU V142	TM 21	24362505	-		○
	370	25	26	80 NBR B246	Seal Set 0215	24241348	-		○
	375,5	7,6	8,1	PTFE B602 / FKM	OMK-E	49062092	-		○
	375,5	7,6	8,1	PTFE B602 / NBR	OMK-E	49062093	-		○
	375,5	7,6	8,1	PTFE GM201 / NBR	OMK-E	49062094	-		○
	375,5	7,7	8,1	PTFE GM201 / NBR	OMK-MR	24123281	-		○
	375,5	7,7	8,1	PTFE B602 / NBR	OMK-MR	24179254	IP		●
400	375,5	7,7	8,1	PTFE B602 / FKM	OMK-MR	24340953	-		○
	376	7,6	8,1	PTFE B602 / NBR	OMK-E	24234456	IP		●
	376	7,6	8,1	PTFE GM201 / NBR	OMK-E	24276366	-		○
	376	7,6	8,1	PTFE B602 / FKM	OMK-E	24345152	-		○
	376	7,6	8,1	PTFE B602 / FKM	OMK-E	24354842	-		○
	376	11,7	12	19YF / 80 A980	SPG	GS3361-V0	-	○	
	380	9,8	10	19YF / 70 A305	SPGO	GS1857-V0	-	○	
	385	10,5	11	31BF / 70 A305	SPGC	GS1120-F0	-	○	
405	380,5	7,7	8,1	PTFE B602 / FKM	OMK-MR	24379676	-		○
405,6	370,6	17	17,5	PTFE GM201	OMK-S	24274785	-		○
	370	40	41,5	BH-NBR B4B246	EK	24076734	-		○
	370	50	51,8	BH-NBR B4B246	EK	24134434	IP		●
	375	16,4	17,5	PTFE GM201	OMK-ES	24213829	-		○
	385,5	7,7	8,1	PTFE GM201 / NBR	OMK-MR	24145195	-		○
410	385,5	7,7	8,1	PTFE B602 / NBR	OMK-MR	24275480	IP		●
	385,5	7,7	8,1	PTFE B602 / FKM	OMK-MR	24349353	-		○
	386	7,6	8,1	PTFE B602 / NBR	OMK-E	24275937	-		○
	386	7,6	8,1	PTFE GM201 / NBR	OMK-E	24276258	-		○
	386	7,6	8,1	PTFE B602 / FKM	OMK-E	24345153	-		○
415	390	15	16	90 NBR 109	N 1	17233	-		○
	390,5	7,7	8,1	PTFE B602 / NBR	OMK-MR	49027295	-		○
	380	20	21	90 NBR 109	N 1	17231	-		○
	380	40	41,5	BH-NBR B4B246	EK	24078766	-		○
	380	50	51,8	BH-NBR B4B246	EK	24179322	-		○
	385	17	17,5	PTFE GM201	OMK-S	24128871	-		○
	390	14,5	15	PTFE B602	OMK-S	49020202	-		○
	390	23,7	26	95 AU V142	TM 21	24368178	-		○
	390	23,7	26	93 AU V167	TMP 21	24372719	-		○
420	390	25	26	80 NBR B246	Seal Set 0215	24238275	-		○
	390	25	26	80 NBR B246	Seal Set 0217	24245492	-		○
	395,5	7,7	8,1	PTFE B602 / NBR	OMK-MR	24234537	IP		●
	395,5	7,7	8,1	PTFE GM201 / NBR	OMK-MR	24240756	-		○
	395,5	7,7	8,1	PTFE B602 / FKM	OMK-MR	24344111	-		○
	396	7,6	8,1	PTFE B602 / NBR	OMK-E	24275939	-		○
	396	7,6	8,1	PTFE GM201 / NBR	OMK-E	24276260	-		○
	396	7,6	8,1	PTFE B602 / FKM	OMK-E	24345154	-		○
425	400,5	7,7	8,1	PTFE B602 / NBR	OMK-MR	527933	-		○
	401	7,6	8,1	PTFE B602 / FKM	OMK-E	24371107	-		○
	400	23,7	26	95 AU V142	TM 21	24368179	-		○
	400	23,7	26	93 AU V167	TMP 21	24368215	-		○
430	400	25	26	90 NBR 109	N 100	1484	-		○
	400	25	26	80 NBR B246	Seal Set 0215	24292148	-		○
	400	25	26	80 NBR B246	Seal Set 0217	24292147	-		○

D [mm]	d [mm]	H [mm]	L [mm]	Material	Design	Part No.	PU ¹⁾	US	EU
430	405,5	7,7	8,1	PTFE B602 / NBR	OMK-MR	24274578	IP		●
	405,5	7,7	8,1	PTFE GM201 / NBR	OMK-MR	24275683	-		○
	405,5	7,7	8,1	PTFE B602 / FKM	OMK-MR	24349354	-		○
	406	7,6	8,1	PTFE B602 / NBR	OMK-E	24275941	-		○
	406	7,6	8,1	PTFE GM201 / NBR	OMK-E	24276262	-		○
	406	7,6	8,1	PTFE B602 / FKM	OMK-E	24345155	-		○
435	410,5	7,7	8,1	PTFE C104 / NBR	OMK-MR	49023946	IP		●
440	400	20	21	90 NBR 109	N 1	17234 1723400	IP	○	○
	400	40	41,5	BH-NBR B4B210	EK	24088254	-	○	○
	400	50	51,8	BH-NBR B4B210	EK	24220081	-		○
	405	17	17,5	PTFE GM201	OMK-S	24209080	-		○
	415,5	7,7	8,1	PTFE GM201 / NBR	OMK-MR	24194521	-		○
	415,5	7,7	8,1	PTFE B602 / NBR	OMK-MR	24275478	-		○
	415,5	7,7	8,1	PTFE B602 / FKM	OMK-MR	24349355	-		○
	416	7,6	8,1	PTFE B602 / NBR	OMK-E	24275943	-		○
	416	7,6	8,1	PTFE GM201 / NBR	OMK-E	24276264	-		○
	416	7,6	8,1	PTFE B602 / FKM	OMK-E	24354843	-		○
450	380	20	8	88 NBR 101	T OF	15753	-		○
	410	24	4	88 NBR 101	T OF	15754	-		○
	410	30	32	80 NBR B246	Seal Set 0215	24245119	-		○
	410	30	32	80 NBR B246	Seal Set 0217	24245493	-		○
	410	40	41,5	BH-NBR B4B210	EK	24108468	IP		●
	410	50	51,8	BH-NBR B4B210	EK	24220082	-		○
	415	17	17,5	PTFE GM201	OMK-S	24141888	-		○
	415	17	17,5	PTFE B602	OMK-S	24338025	-		○
	420	15	16	90 NBR 109	N 1	17239	-		○
	420	23,7	26	95 AU V142	TM 21	24368180	-		○
	420	23,7	26	93 AU V167	TMP 21	24368216	-		○
	420	25	26	80 NBR B246	Seal Set 0215	24245122	-		○
	420	25	26	80 NBR B246	Seal Set 0217	24240357	-		○
	425,5	7,7	8,1	PTFE B602 / NBR	OMK-MR	24269426	-		○
	425,5	7,7	8,1	PTFE GM201 / NBR	OMK-MR	24275678	-		○
	425,5	7,7	8,1	PTFE B602 / FKM	OMK-MR	24349356	-		○
	426	7,6	8,1	PTFE B602 / NBR	OMK-E	24275945	-		○
	426	7,6	8,1	PTFE GM201 / NBR	OMK-E	24276266	-		○
426	7,6	8,1	PTFE B602 / FKM	OMK-E	24345157	-		○	
452	427,5	7,7	8,1	PTFE B602 / NBR	OMK-MR	24359162	-		○
453	429	7,6	8,1	PTFE GM201 / FKM	OMK-E	49030890	-		○
455	420	17	17,5	PTFE GM201	OMK-S	24235223	-		○
457,2	432,7	7,7	8,1	PTFE B602 / NBR	OMK-MR	24349891	-		○
460	420	29,1	32	95 AU V142	TM 21	24371311	-		○
	420	40	41,5	BH-NBR B4B210	EK	24113757	-		○
	420	50	51,8	BH-NBR B4B210	EK	24080149	-		○
	425	17	17,5	PTFE GM201	OMK-S	24090834	-		○
	425	17	17,5	PTFE B602	OMK-S	24337032	-		○
	430	14,5	15	PTFE GM201	OMK-S	24373069	-		○
	435,5	7,7	8,1	PTFE GM201 / NBR	OMK-MR	24174791	-		○
	435,5	7,7	8,1	PTFE B602 / NBR	OMK-MR	24259026	IP		●
	435,5	7,7	8,1	PTFE B602 / FKM	OMK-MR	24349357	-		○

D [mm]	d [mm]	H [mm]	L [mm]	Material	Design	Part No.	PU ¹⁾	US	EU
460	435,5	7,7	8,1	PTFE C104 / NBR	OMK-MR	49044247	-		○
	436	7,6	8,1	PTFE B602 / NBR	OMK-E	24275947	-		○
	436	7,6	8,1	PTFE GM201 / NBR	OMK-E	24276268	-		○
	436	7,6	8,1	PTFE B602 / FKM	OMK-E	24345158	-		○
465	440,5	7,7	8,1	PTFE B602 / NBR	OMK-MR	24355453	-		○
	440,5	7,7	8,1	PTFE C104 / NBR	OMK-MR	49004010	-		○
	440,5	7,7	8,1	PTFE GM201 / NBR	OMK-MR	49016027	-		○
	440,5	7,7	8,1	PTFE B602 / FKM	OMK-MR	525314	-		○
470	435	17	17,5	PTFE GM201	OMK-S	24261687	-		○
	440	23,7	26	95 AU V142	TM 21	24368182	-		○
	440	25	26	80 NBR B246	Seal Set 0215	24266415	-		○
	440	25	26	80 NBR B246	Seal Set 0217	24266416	-		○
	445,5	7,7	8,1	PTFE B602 / NBR	OMK-MR	24275477	-		○
	445,5	7,7	8,1	PTFE GM201 / NBR	OMK-MR	24275646	-		○
	445,5	7,7	8,1	PTFE B602 / FKM	OMK-MR	24349358	-		○
	446	7,6	8,1	PTFE B602 / NBR	OMK-E	24275949	-		○
	446	7,6	8,1	PTFE GM201 / NBR	OMK-E	24276269	-		○
	446	7,6	8,1	PTFE B602 / FKM	OMK-E	24345159	-		○
475	412	30	5	88 NBR 101	T OF	15759	-		○
	440	17	17,5	PTFE B602	OMK-S	528872	-		○
	450,5	7,7	8,1	PTFE GM201 / NBR	OMK-MR	24308271	-		○
480	440	25	26	90 NBR 109	N 1	17242	-	○	○
	440	40	41,5	BH-NBR B4B210	EK	24073599	-		○
	440	50	51,8	BH-NBR B4B210	EK	24083862	-		○
	445	17	17,5	PTFE GM201	OMK-S	24224712	-		○
	450	23,7	26	95 AU V142	TM 21	24368183	-		○
	450	23,7	26	93 AU V167	TMP 21	24370400	-		○
	450	25	26	80 NBR B246	Seal Set 0215	24249169	-		○
	450	25	26	80 NBR B246	Seal Set 0217	24250323	-		○
	455,5	7,7	8,1	PTFE GM201 / NBR	OMK-MR	24194143	-		○
	455,5	7,7	8,1	PTFE B602 / NBR	OMK-MR	24275483	-		○
	455,5	7,7	8,1	PTFE B602 / FKM	OMK-MR	24349359	-		○
	456	7,6	8,1	PTFE B602 / NBR	OMK-E	24275951	-		○
	456	7,6	8,1	PTFE GM201 / NBR	OMK-E	24276270	-		○
	456	7,6	8,1	PTFE B602 / FKM	OMK-E	24345160	-		○
482	457,5	7,7	8,1	PTFE B602 / NBR	OMK-MR	24367350	-		○
485	455	14,8	15	19YF / 80 A980	SPG	GS0504-V1	-	○	
490	450	34	35,5	80 NBR B246	Seal Set 0215	24297820	-		○
	450	40	41,5	BH-NBR B4B210	EK	24082627	-		○
	450	50	51,8	BH-NBR B4B210	EK	24083228	-		○
	465,5	7,7	8,1	PTFE B602 / NBR	OMK-MR	24275479	-		○
	465,5	7,7	8,1	PTFE GM201 / NBR	OMK-MR	24275481	-		○
	465,5	7,7	8,1	PTFE B602 / FKM	OMK-MR	24328252	-		○
	466	7,6	8,1	PTFE B602 / NBR	OMK-E	24275953	-		○
	466	7,6	8,1	PTFE GM201 / NBR	OMK-E	24276271	-		○
	466	7,6	8,1	PTFE B602 / FKM	OMK-E	24345161	-		○
500	431	24	5	88 NBR 101	T OF	15765	-		○
	460	20	21	90 NBR 109	N 1	17248	-		○
	460	23,9	25,4	80 NBR B246	Seal Set 0217	24351681	-		○
	460	40	41,5	BH-NBR B4B210	EK	24220083	-		○

D [mm]	d [mm]	H [mm]	L [mm]	Material	Design	Part No.	PU ¹⁾	US	EU
	460	50	51,8	BiNBR B4B210	EK	24220084	-		○
	465	16,4	17,5	PTFE B602	OMK-ES	24346901	-		○
	465	16,4	17,5	PTFE GM201	OMK-ES	49013401	-		○
	465	17	17,5	PTFE GM201	OMK-S	24130656	-		○
	465	17	17,5	PTFE B602	OMK-S	24344252	-		○
	470	14,8	15	19YF / 80 A980	SPG	GS0261-V2	-	○	
	470	23,7	26	95 AU V142	TM 21	24368184	-		○
	470	23,7	26	93 AU V167	TMP 21	24368217	-		○
500	470	25	26	80 NBR B246	Seal Set O215	24292218	-		○
	470	25	26	80 NBR B246	Seal Set O217	24269878	-		○
	475,5	7,6	8,1	PTFE B602 / FKM	OMK-E	49062095	-		○
	475,5	7,6	8,1	PTFE B602 / NBR	OMK-E	49062096	-		○
	475,5	7,6	8,1	PTFE GM201 / NBR	OMK-E	49062097	-		○
	475,5	7,7	8,1	PTFE B602 / NBR	OMK-MR	24268694	-		○
	475,5	7,7	8,1	PTFE GM201 / NBR	OMK-MR	24268696	IP		●
	475,5	7,7	8,1	PTFE B602 / FKM	OMK-MR	24349360	-		○
	476	7,6	8,1	PTFE B602 / NBR	OMK-E	24275955	-		○
	476	7,6	8,1	PTFE GM201 / NBR	OMK-E	24276273	-		○
	476	7,6	8,1	PTFE B602 / FKM	OMK-E	24345162	-		○
508	483,5	7,7	8,1	PTFE B602 / NBR	OMK-MR	24358308	-		○
	470	40	41,5	BiNBR B4B210	EK	24091197	-		○
	470	50	51,8	BiNBR B4B210	EK	24097617	-		○
	475	17	17,5	PTFE GM201	OMK-S	24357906	-		○
	485,5	7,7	8,1	PTFE B602 / NBR	OMK-MR	24275482	-		○
510	485,5	7,7	8,1	PTFE GM201 / NBR	OMK-MR	24275681	-		○
	485,5	7,7	8,1	PTFE B602 / FKM	OMK-MR	24349361	-		○
	485,5	7,7	8,1	PTFE C104 / NBR	OMK-MR	49022888	IP		●
	486	7,6	8,1	PTFE B602 / NBR	OMK-E	24275957	-		○
	486	7,6	8,1	PTFE GM201 / NBR	OMK-E	24276275	-		○
	486	7,6	8,1	PTFE B602 / FKM	OMK-E	24345163	-		○
510,2	486,2	7,6	8,1	PTFE B602 / NBR	OMK-E	24355921	-		○
515	490,5	7,7	8,1	PTFE B602 / NBR	OMK-MR	24344662	-		○
517	493	7,6	8,1	PTFE GM201 / FKM	OMK-E	49021237	-		○
	480	40	41,5	BiNBR B4B210	EK	24087936	-		○
	480	50	51,8	BiNBR B4B210	EK	24069860	-		○
	485	16,4	17,5	PTFE GM201	OMK-ES	24357903	-		○
	485	17	17,5	PTFE GM201	OMK-S	24179374	-		○
520	495,5	7,7	8,1	PTFE B602 / NBR	OMK-MR	24269669	-		○
	495,5	7,7	8,1	PTFE GM201 / NBR	OMK-MR	24275655	-		○
	495,5	7,7	8,1	PTFE B602 / FKM	OMK-MR	24327515	-		○
	496	7,6	8,1	PTFE B602 / NBR	OMK-E	24275959	-		○
	496	7,6	8,1	PTFE GM201 / NBR	OMK-E	24276277	-		○
	496	7,6	8,1	PTFE B602 / FKM	OMK-E	24345164	-		○
520,7	496,2	7,7	8,1	PTFE GM201 / NBR	OMK-MR	24224007	-		○
	496,2	7,7	8,1	PTFE B602 / NBR	OMK-MR	24349893	-		○
525	500,5	7,7	8,1	PTFE B602 / NBR	OMK-MR	49040287	-		○
	501	7,6	8,1	PTFE GM201 / FKM	OMK-E	49029364	-		○
530	495	17	17,5	PTFE GM201	OMK-S	24195593	-		○
	500	23,7	26	93 AU V167	TMP 21	24368219	-		○
	500	25	26	80 NBR B246	Seal Set O215	24241691	-		○

D [mm]	d [mm]	H [mm]	L [mm]	Material	Design	Part No.	PU ¹⁾	US	EU
530	500	25	26	80 NBR B246	Seal Set 0217	24245121	-		○
	505,5	7,7	8,1	PTFE B602 / NBR	OMK-MR	24275489	IP		●
	505,5	7,7	8,1	PTFE GM201 / NBR	OMK-MR	24275659	-		○
	505,5	7,7	8,1	PTFE B602 / FKM	OMK-MR	24349362	-		○
	506	7,6	8,1	PTFE B602 / NBR	OMK-E	24275961	-		○
	506	7,6	8,1	PTFE GM201 / NBR	OMK-E	24276279	-		○
	506	7,6	8,1	PTFE B602 / FKM	OMK-E	24354844	-		○
532,8	508,3	8,1	8,1	PTFE GM201 / NBR	OMK-MR	532814	-		○
540	500	40	41,5	BH-NBR B4B210	EK	24085075	-		○
	500	50	64,5	BH-NBR B4B210	EK	24082317	-		○
	505	17	17,5	PTFE GM201	OMK-S	24090835	-		○
	515,5	7,7	8,1	PTFE B602 / NBR	OMK-MR	24275492	-		○
	515,5	7,7	8,1	PTFE GM201 / NBR	OMK-MR	24275684	IP		●
	515,5	7,7	8,1	PTFE B602 / FKM	OMK-MR	24349363	-		○
	515,5	7,7	8,1	PTFE C104 / NBR	OMK-MR	49023947	IP		●
	516	7,6	8,1	PTFE B602 / NBR	OMK-E	24275963	-		○
	516	7,6	8,1	PTFE GM201 / NBR	OMK-E	24276281	-		○
516	7,6	8,1	PTFE B602 / FKM	OMK-E	24345166	-		○	
550	510	27	4	88 NBR 101	T OF	15776	-		○
	510	40	41,5	BH-NBR B4B210	EK	24343760	-		○
	510	50	51,8	BH-NBR B4B210	EK	24343761	-		○
	515	16,4	17,5	PTFE GM201	OMK-ES	24372694	-		○
	515	17	17,5	PTFE GM201	OMK-S	24135192	IP		●
	515	17,2	17,5	19YF / 80 A980	SPG	GS0379-V2	-	○	
	520	23,7	26	93 AU V168	TMP 21	24380029	-		○
	525,5	7,7	8,1	PTFE B602 / NBR	OMK-MR	24275494	-		○
	525,5	7,7	8,1	PTFE GM201 / NBR	OMK-MR	24275665	-		○
	525,5	7,7	8,1	PTFE B602 / FKM	OMK-MR	24349364	-		○
	526	7,6	8,1	PTFE B602 / NBR	OMK-E	24275965	-		○
	526	7,6	8,1	PTFE GM201 / NBR	OMK-E	24276283	-		○
526	7,6	8,1	PTFE B602 / FKM	OMK-E	24345167	-		○	
560	510	50	51,8	BH-NBR B4B210	EK	24083477	-		○
	510	62,5	64,5	BH-NBR B4B210	EK	24082090	-		○
	520	29,1	32	93 AU V168	TM 21	24373869	-		○
	525	17	17,5	PTFE GM201	OMK-S	24108716	-		○
	530	23,7	26	93 AU V168	TM 21	24370483	-		○
	530	23,7	26	93 AU V168	TMP 21	24368220	-		○
	530	25	26	80 NBR B246	Seal Set 0217	24266461	-		○
	535,5	7,7	8,1	PTFE B602 / NBR	OMK-MR	24275490	IP		●
	535,5	7,7	8,1	PTFE GM201 / NBR	OMK-MR	24275667	-		○
	535,5	7,7	8,1	PTFE B602 / FKM	OMK-MR	24349365	-		○
	535,5	8,1	8,1	PTFE C104 / NBR	OMK-MR	49008962	-		○
	536	7,6	8,1	PTFE B602 / NBR	OMK-E	24275967	-		○
	536	7,6	8,1	PTFE GM201 / NBR	OMK-E	24276285	-		○
	536	7,6	8,1	PTFE B602 / FKM	OMK-E	24345168	-		○
565	530	17	17,5	PTFE GM201	OMK-S	24227409	-		○
	530	17	17,5	PTFE B602	OMK-S	24378479	-		○
570	530	40	41,5	BH-NBR B4B210	EK	24287015	-		○
	530	50	51,8	BH-NBR B4B210	EK	24214286	-		○
	535	17	17,5	PTFE GM201	OMK-S	24127145	-		○

D [mm]	d [mm]	H [mm]	L [mm]	Material	Design	Part No.	PU ¹⁾	US	EU
570	535	17	17,5	PTFE B602	OMK-S	24351056	-		○
	545,5	7,7	8,1	PTFE GM201 / NBR	OMK-MR	24275476	-		○
	545,5	7,7	8,1	PTFE B602 / NBR	OMK-MR	24275486	-		○
	545,5	7,7	8,1	PTFE B602 / FKM	OMK-MR	24349366	-		○
	546	7,6	8,1	PTFE B602 / NBR	OMK-E	24275969	-		○
	546	7,6	8,1	PTFE GM201 / NBR	OMK-E	24276287	-		○
	546	7,6	8,1	PTFE B602 / FKM	OMK-E	24345169	-		○
576	552	7,6	8,1	PTFE GM201 / FKM	OMK-E	24377716	-		○
580	530	50	51,8	BH-NBR B4B210	EK	24113726	-		○
	530	62,5	64,5	BH-NBR B4B210	EK	24091357	-		○
	540	40	41,5	BH-NBR B4B210	EK	24220085	-		○
	540	50	51,8	BH-NBR B4B210	EK	24220086	-		○
	545	17	17,5	PTFE GM201	OMK-S	24215675	-		○
	545	17	17,5	PTFE B602	OMK-S	24344253	-		○
	555,5	7,7	8,1	PTFE B602 / NBR	OMK-MR	24275493	-		○
	555,5	7,7	8,1	PTFE GM201 / NBR	OMK-MR	24275661	-		○
	555,5	7,7	8,1	PTFE B602 / FKM	OMK-MR	24349367	-		○
	556	7,6	8,1	PTFE B602 / NBR	OMK-E	24275971	-		○
	556	7,6	8,1	PTFE GM201 / NBR	OMK-E	24276289	-		○
556	7,6	8,1	PTFE B602 / FKM	OMK-E	24345170	-		○	
583	548	17	17,5	PTFE GM201	OMK-S	24375265	-		○
584,2	559,7	7,7	8,1	PTFE B602 / NBR	OMK-MR	24343001	-		○
590	550	50	51,8	BH-NBR B4B210	EK	24087597	-		○
	555	17	17,5	PTFE GM201	OMK-S	24144379	-		○
	565,5	7,7	8,1	PTFE B602 / NBR	OMK-MR	24275497	-		○
	565,5	7,7	8,1	PTFE GM201 / NBR	OMK-MR	24275666	-		○
	565,5	7,7	8,1	PTFE B602 / FKM	OMK-MR	24349368	-		○
	566	7,6	8,1	PTFE B602 / NBR	OMK-E	24275973	-		○
	566	7,6	8,1	PTFE GM201 / NBR	OMK-E	24276291	-		○
	566	7,6	8,1	PTFE B602 / FKM	OMK-E	24345171	-		○
600	560	23,7	26	93 AU V168	TM 21	24368186	-		○
	560	24,9	26,5	93 AU V168	TMP 21	24368221	-		○
	560	25	26,5	80 NBR B246	Seal Set O217	24250324	-		○
	560	40	41,5	BH-NBR B4B210	EK	24067724	-		○
	560	50	51,8	BH-NBR B4B210	EK	24077886	-		○
	565	16,4	17,5	PTFE B602	OMK-ES	24338042	-		○
	565	17	17,5	PTFE GM201	OMK-S	24224706	-		○
	565	17	17,5	PTFE B602	OMK-S	24338026	-		○
	570	14,8	15	19YF / 80 A980	SPG	GS0324-V2	-	○	
	575,5	7,7	8,1	PTFE GM201 / NBR	OMK-MR	24145899	-		○
	575,5	7,7	8,1	PTFE B602 / NBR	OMK-MR	24191702	-		○
	575,5	7,7	8,1	PTFE B602 / FKM	OMK-MR	24349370	-		○
	576	7,6	8,1	PTFE B602 / NBR	OMK-E	24275975	-		○
	576	7,6	8,1	PTFE GM201 / NBR	OMK-E	24276293	-		○
	576	7,6	8,1	PTFE B602 / FKM	OMK-E	24345172	-		○
606	582	7,6	8,1	PTFE GM201 / FKM	OMK-E	49020174	-		○
609,6	585,1	7,7	8,1	PTFE B602 / NBR	OMK-MR	24370146	-		○
610	560	50	51,8	BH-NBR B4B210	EK	24220087	-		○
	560	62,5	64,5	BH-NBR B4B210	EK	24099113	-		○
	570	24,9	26,5	93 AU V168	TMP 21	49001223	-		○

D [mm]	d [mm]	H [mm]	L [mm]	Material	Design	Part No.	PU ¹⁾	US	EU
610	575	17	17,5	PTFE GM201	OMK-S	24224709	-		○
	585,5	7,7	8,1	PTFE GM201 / NBR	OMK-MR	24233565	-		○
	585,5	7,7	8,1	PTFE B602 / NBR	OMK-MR	24234535	-		○
	585,5	7,7	8,1	PTFE B602 / FKM	OMK-MR	24349371	-		○
	586	7,6	8,1	PTFE B602 / NBR	OMK-E	24275977	-		○
	586	7,6	8,1	PTFE GM201 / NBR	OMK-E	24276295	-		○
	586	7,6	8,1	PTFE B602 / FKM	OMK-E	24345173	-		○
616	592	7,6	8,1	PTFE GM201 / FKM	OMK-E	49021875	-		○
620	580	40	41,5	BH-NBR B4B210	EK	24090558	-		○
	580	50	51,8	BH-NBR B4B210	EK	24170779	-		○
	585	16,4	17,5	PTFE GM201	OMK-ES	530238	-		○
	585	17	17,5	PTFE GM201	OMK-S	24191196	IP		●
	585	17	17,5	PTFE GM201	OMK-S	24315328	-		○
	585	17	17,5	PTFE B602	OMK-S	24349775	-		○
	592	9	9,5	PTFE B602 / FKM	OMK-MR	24376612	-		○
	595,5	7,7	8,1	PTFE B602 / NBR	OMK-MR	24275487	-		○
	595,5	7,7	8,1	PTFE GM201 / NBR	OMK-MR	24275675	-		○
	595,5	7,7	8,1	PTFE B602 / FKM	OMK-MR	24316069	-		○
	596	7,6	8,1	PTFE B602 / NBR	OMK-E	24275979	-		○
	596	7,6	8,1	PTFE GM201 / NBR	OMK-E	24276297	-		○
	596	7,6	8,1	PTFE B602 / FKM	OMK-E	24345174	-		○
625	600,5	7,7	8,1	PTFE B602 / NBR	OMK-MR	24380876	-		○
626	602	7,6	8,1	PTFE GM201 / FKM	OMK-E	49020482	-		○
630	580	32	34	80 NBR B246	Seal Set 0217	24331932	-		○
	580	50	51,8	BH-NBR B4B210	EK	24141229	-		○
	580	62,5	64,5	BH-NBR B4B210	EK	24094418	-		○
	590	40	41,5	BH-NBR B4B210	EK	24068741	-		○
	590	50	51,8	BH-NBR B4B210	EK	24083633	-		○
	595	17	17,5	PTFE GM201	OMK-S	24139430	-		○
	595	17	17,5	PTFE B602	OMK-S	24344254	-		○
	600	23,7	26	93 AU V168	TMP 21	24367303	-		○
	600	25	26	80 NBR B246	Seal Set 0217	24269879	-		○
	605,5	7,7	8,1	PTFE B602 / NBR	OMK-MR	24275498	-		○
	605,5	7,7	8,1	PTFE GM201 / NBR	OMK-MR	24275647	-		○
	605,5	7,7	8,1	PTFE B602 / FKM	OMK-MR	24347059	-		○
	605,5	7,7	8,1	PTFE C104 / NBR	OMK-MR	49023948	IP		●
	606	7,6	8,1	PTFE B602 / NBR	OMK-E	24275981	-		○
	606	7,6	8,1	PTFE GM201 / NBR	OMK-E	24276299	-		○
606	7,6	8,1	PTFE B602 / FKM	OMK-E	24345175	-		○	
632,5	597,5	17	17,5	PTFE B602	OMK-S	24376135	-		○
635	611	7,6	8,1	PTFE GM201 / NBR	OMK-E	49008518	-		○
640	600	50	51,8	BH-NBR B4B210	EK	24247385	-		○
	605	17	17,5	PTFE GM201	OMK-S	24224708	-		○
	605	17	17,5	PTFE B602	OMK-S	24342904	-		○
	615,5	7,7	8,1	PTFE B602 / NBR	OMK-MR	24243559	-		○
	615,5	7,7	8,1	PTFE GM201 / NBR	OMK-MR	24275668	-		○
	615,5	7,7	8,1	PTFE B602 / FKM	OMK-MR	24349372	-		○
	615,5	7,7	8,1	PTFE C104 / NBR	OMK-MR	49008963	-		○
	616	7,6	8,1	PTFE B602 / NBR	OMK-E	24275983	-		○
	616	7,6	8,1	PTFE GM201 / NBR	OMK-E	24276331	-		○

D [mm]	d [mm]	H [mm]	L [mm]	Material	Design	Part No.	PU ¹⁾	US	EU
640	616	7,6	8,1	PTFE B602 / FKM	OMK-E	24345176	-		○
650	600	50	51,8	BHNBR B4B210	EK	24073080	-		○
	600	62,5	64,5	BHNBR B4B210	EK	24082118	IP		●
	615	17	17,5	PTFE GM201	OMK-S	24224711	-		○
	620	14,8	15	19YF / 80 A980	SPG	GS0527-V0	-	○	
	625,5	7,7	8,1	PTFE B602 / NBR	OMK-MR	24268698	-		○
	625,5	7,7	8,1	PTFE GM201 / NBR	OMK-MR	24268700	-		○
	625,5	7,7	8,1	PTFE B602 / FKM	OMK-MR	24349373	-		○
	626	7,6	8,1	PTFE B602 / NBR	OMK-E	24275985	-		○
	626	7,6	8,1	PTFE GM201 / NBR	OMK-E	24276332	-		○
	626	7,6	8,1	PTFE B602 / FKM	OMK-E	24345177	-		○
655	620	17	17,5	PTFE GM201	OMK-S	49015993	-		○
	630,5	7,7	8,1	PTFE B602 / NBR	OMK-MR	49039525	-		○
660	620	24,9	26,5	93 AU V168	TMP 21	49001224	-		○
	625	16,4	17,5	PTFE B602	OMK-ES	24291575	-		○
	625	17	17,5	PTFE GM201	OMK-S	24214031	-		○
	625	17	17,5	PTFE C104	OMK-S	49024946	-		○
	625	17	17,5	PTFE GM201	OMK-S	49027324	-		○
	635,5	7,7	8,1	PTFE B602 / NBR	OMK-MR	24275495	-		○
	635,5	7,7	8,1	PTFE GM201 / NBR	OMK-MR	24275637	-		○
	635,5	7,7	8,1	PTFE B602 / FKM	OMK-MR	24349374	-		○
	636	7,6	8,1	PTFE B602 / NBR	OMK-E	24275987	-		○
	636	7,6	8,1	PTFE GM201 / NBR	OMK-E	24276333	-		○
660,4	635,9	7,7	8,1	PTFE B602 / NBR	OMK-MR	24361509	-		○
670	630	24,9	26,5	93 AU V168	TMP 21	24376128	-		○
	630	25	26,5	80 NBR B246	Seal Set 0217	24250098	-		○
	630	25	28	80 NBR B246	Seal Set 0215	24250325	-		○
	630	40	41,5	BHNBR B4B210	EK	24074848	-		○
	630	50	51,8	BHNBR B4B210	EK	24074849	-		○
	635	17	17,5	PTFE GM201	OMK-S	24224714	-		○
	642	9	9,5	PTFE B602 / NBR	OMK-MR	24275502	-		○
	642	9	9,5	PTFE GM201 / NBR	OMK-MR	24275660	-		○
	642	9	9,5	PTFE B602 / FKM	OMK-MR	24349458	-		○
	642,7	8,7	9,5	PTFE B602 / NBR	OMK-E	24275989	-		○
	642,7	8,7	9,5	PTFE GM201 / NBR	OMK-E	24276335	-		○
	642,7	8,7	9,5	PTFE B602 / FKM	OMK-E	24345179	-		○
	680	640	29,1	32	93 AU V168	TM 21	24368188	-	
640		30	32	80 NBR B246	Seal Set 0215	24265070	-		○
640		30	32	80 NBR B246	Seal Set 0217	24237741	-		○
645		17	17,5	PTFE GM201	OMK-S	24224724	-		○
645		17	17,5	PTFE B602	OMK-S	24344255	-		○
652		9	9,5	PTFE B602 / NBR	OMK-MR	24275499	-		○
652		9	9,5	PTFE GM201 / NBR	OMK-MR	24275682	-		○
652		9	9,5	PTFE B602 / FKM	OMK-MR	24349459	-		○
652		9	9,5	PTFE C104 / NBR	OMK-MR	49023949	IP		●
652,7		8,7	9,5	PTFE B602 / NBR	OMK-E	24269413	-		○
652,7		8,7	9,5	PTFE GM201 / NBR	OMK-E	24276337	-		○
652,7		8,7	9,5	PTFE B602 / FKM	OMK-E	24345180	-		○
690		655	17	17,5	PTFE GM201	OMK-S	24224729	-	

D [mm]	d [mm]	H [mm]	L [mm]	Material	Design	Part No.	PU ¹⁾	US	EU
690	662	9	9,5	PTFE B602 / NBR	OMK-MR	24275501	-		○
	662	9	9,5	PTFE GM201 / NBR	OMK-MR	24275676	-		○
	662	9	9,5	PTFE B602 / FKM	OMK-MR	24349460	-		○
	662,7	8,7	9,5	PTFE B602 / NBR	OMK-E	24275993	-		○
	662,7	8,7	9,5	PTFE GM201 / NBR	OMK-E	24276338	-		○
	662,7	8,7	9,5	PTFE B602 / FKM	OMK-E	24345181	-		○
700	660	24,9	26,5	93 AU V168	TMP 21	49001225	-		○
	665	17	17,5	PTFE GM201	OMK-S	24143108	-		○
	672	9	9,5	PTFE B602 / NBR	OMK-MR	24268832	-		○
	672	9	9,5	PTFE GM201 / NBR	OMK-MR	24268834	-		○
	672	9	9,5	PTFE B602 / FKM	OMK-MR	24349461	-		○
	672,7	8,7	9,5	PTFE B602 / NBR	OMK-E	24275995	-		○
	672,7	8,7	9,5	PTFE GM201 / NBR	OMK-E	24276339	-		○
710	670	23,7	26	93 AU V168	TM 21	24377403	-		○
	670	24,9	26,5	93 AU V168	TMP 21	24368222	-		○
	670	25	26,5	80 NBR B246	Seal Set 0217	24238026	-		○
	670	25	28	80 NBR B246	Seal Set 0215	24245120	-		○
	675	17	17,5	PTFE GM201	OMK-S	24188274	-		○
	675	17	17,5	PTFE B602	OMK-S	24367548	-		○
	682	9	9,5	PTFE B602 / NBR	OMK-MR	24275488	-		○
	682	9	9,5	PTFE GM201 / NBR	OMK-MR	24275674	-		○
	682	9	9,5	PTFE B602 / FKM	OMK-MR	24349462	-		○
	682,7	8,7	9,5	PTFE B602 / NBR	OMK-E	24269414	-		○
	682,7	8,7	9,5	PTFE B602 / NBR	OMK-E	24275997	-		○
	682,7	8,7	9,5	PTFE GM201 / NBR	OMK-E	24276341	-		○
	682,7	8,7	9,5	PTFE B602 / FKM	OMK-E	24345183	-		○
711,2	676,2	17	17,5	PTFE GM201	OMK-S	24243964	-		○
715	687,7	8,7	9,5	PTFE B602 / NBR	OMK-E	24367412	-		○
720	670	50	51,8	BH-NBR B4B210	EK	24181627	-		○
	670	62,5	64,5	BH-NBR B4B210	EK	24077483	-		○
	685	16,4	17,5	PTFE GM201	OMK-ES	24213578	-		○
	685	17	17,5	PTFE GM201	OMK-S	24178331	-		○
	685	17	17,5	PTFE B602	OMK-S	24338732	-		○
	690	14,8	15	19YF / 80 A980	SPG	GS0492V0	-	○	
	692	9	9,5	PTFE B602 / NBR	OMK-MR	24275500	IP		●
	692	9	9,5	PTFE GM201 / NBR	OMK-MR	24275650	-		○
	692	9	9,5	PTFE B602 / FKM	OMK-MR	24349463	-		○
	692,7	8,7	9,5	PTFE B602 / NBR	OMK-E	24275999	-		○
730	692,7	8,7	9,5	PTFE GM201 / NBR	OMK-E	24276343	-		○
	692,7	8,7	9,5	PTFE B602 / FKM	OMK-E	24345184	-		○
	690	50	51,8	BH-NBR B4B210	EK	24292823	-		○
	695	17	17,5	PTFE GM201	OMK-S	24224726	-		○
	702	9	9,5	PTFE B602 / NBR	OMK-MR	24269480	-		○
	702	9	9,5	PTFE GM201 / NBR	OMK-MR	24275671	-		○
	702	9	9,5	PTFE B602 / FKM	OMK-MR	24349464	-		○
	702,7	8,7	9,5	PTFE B602 / NBR	OMK-E	24276001	-		○
740	702,7	8,7	9,5	PTFE GM201 / NBR	OMK-E	24276345	-		○
	702,7	8,7	9,5	PTFE B602 / FKM	OMK-E	24345185	-		○
	700	40	41,5	BH-NBR B4B210	EK	24142521	-		○

D [mm]	d [mm]	H [mm]	L [mm]	Material	Design	Part No.	PU ¹⁾	US	EU
740	700	50	51,8	BHNBR B4B210	EK	24137458	-		○
	705	16,4	17,5	PTFE GM201	OMK-ES	24378497	-		○
	705	17	17,5	PTFE GM201	OMK-S	24224731	-		○
	705	17	17,5	PTFE C104	OMK-S	49027858	-		○
	712	9	9,5	PTFE B602 / NBR	OMK-MR	24275510	-		○
	712	9	9,5	PTFE GM201 / NBR	OMK-MR	24275664	-		○
	712	9	9,5	PTFE B602 / FKM	OMK-MR	24349465	-		○
	712	9	9,5	PTFE C104 / NBR	OMK-MR	49023950	IP		●
	712,7	8,7	9,5	PTFE B602 / NBR	OMK-E	24276003	-		○
	712,7	8,7	9,5	PTFE GM201 / NBR	OMK-E	24276347	-		○
	712,7	8,7	9,5	PTFE B602 / FKM	OMK-E	24345186	-		○
750	710	18,7	20	PTFE GM201	OMK-ES	49011384	-		○
	710	24,9	26,5	93 AU V168	TMP 21	24368223	-		○
	710	25	26,5	80 NBR B246	Seal Set O215	24294439	-		○
	710	25	26,5	80 NBR B246	Seal Set O217	24289980	-		○
	710	40	41,5	BHNBR B4B210	EK	24105848	-		○
	710	50	51,8	BHNBR B4B210	EK	24080694	-		○
	715	17	17,5	PTFE GM201	OMK-S	24191361	-		○
	722	9	9,5	PTFE B602 / NBR	OMK-MR	24275514	-		○
	722	9	9,5	PTFE GM201 / NBR	OMK-MR	24275663	-		○
	722	9	9,5	PTFE B602 / FKM	OMK-MR	24349466	-		○
	722,7	8,7	9,5	PTFE B602 / NBR	OMK-E	24276005	-		○
722,7	8,7	9,5	PTFE GM201 / NBR	OMK-E	24276349	-		○	
722,7	8,7	9,5	PTFE B602 / FKM	OMK-E	24345187	-		○	
760	710	62,5	64,5	BHNBR B4B210	EK	24339524	-		○
	720	19,5	20	PTFE GM201	OMK-S	24224718	-		○
	732	9	9,5	PTFE B602 / NBR	OMK-MR	24275508	-		○
	732	9	9,5	PTFE GM201 / NBR	OMK-MR	24275679	-		○
	732	9	9,5	PTFE B602 / FKM	OMK-MR	24349467	-		○
	732,7	8,7	9,5	PTFE B602 / NBR	OMK-E	24276007	-		○
	732,7	8,7	9,5	PTFE GM201 / NBR	OMK-E	24276351	-		○
732,7	8,7	9,5	PTFE B602 / FKM	OMK-E	24345188	-		○	
762	734	9	9,5	PTFE B602 / NBR	OMK-MR	24370578	-		○
768	740,7	8,7	9,5	PTFE B602 / NBR	OMK-E	24357894	-		○
770	730	19,5	20	PTFE GM201	OMK-S	24146978	-		○
	730	19,5	20	PTFE B602	OMK-S	24310590	-		○
	742	9	9,5	PTFE B602 / NBR	OMK-MR	24275503	-		○
	742	9	9,5	PTFE GM201 / NBR	OMK-MR	24275644	-		○
	742	9	9,5	PTFE B602 / FKM	OMK-MR	24349468	-		○
	742,7	8,7	9,5	PTFE B602 / NBR	OMK-E	24276009	-		○
	742,7	8,7	9,5	PTFE GM201 / NBR	OMK-E	24276353	-		○
742,7	8,7	9,5	PTFE B602 / FKM	OMK-E	24345189	-		○	
775	735	19,5	20	PTFE GM201	OMK-S	24377268	-		○
780	740	19,5	20	PTFE GM201	OMK-S	24224727	-		○
	752	9	9,5	PTFE B602 / NBR	OMK-MR	24275512	-		○
	752	9	9,5	PTFE GM201 / NBR	OMK-MR	24275662	-		○
	752	9	9,5	PTFE B602 / FKM	OMK-MR	24349469	-		○
	752,7	8,7	9,5	PTFE B602 / NBR	OMK-E	24276011	-		○
	752,7	8,7	9,5	PTFE GM201 / NBR	OMK-E	24276355	-		○
752,7	8,7	9,5	PTFE B602 / FKM	OMK-E	24345190	-		○	

D [mm]	d [mm]	H [mm]	L [mm]	Material	Design	Part No.	PU ¹⁾	US	EU
783	755	9	9,5	PTFE B602 / NBR	OMK-MR	24299039	-		○
790	750	40	41,5	BHNBR B4B210	EK	24220088	-		○
	750	50	51,8	BHNBR B4B210	EK	24149095	-		○
	762	9	9,5	PTFE B602 / NBR	OMK-MR	24275517	-		○
	762	9	9,5	PTFE GM201 / NBR	OMK-MR	24275658	-		○
	762	9	9,5	PTFE B602 / FKM	OMK-MR	24349472	-		○
	762,7	8,7	9,5	PTFE GM201 / NBR	OMK-E	24267605	-		○
	762,7	8,7	9,5	PTFE B602 / NBR	OMK-E	24276013	-		○
	762,7	8,7	9,5	PTFE B602 / FKM	OMK-E	24345191	-		○
800	750	30,5	33,5	93 AU V168	TM 21	24372489	-		○
	750	32	33,5	80 NBR B246	Seal Set 0215	24265071	-		○
	750	32	33,5	80 NBR B246	Seal Set 0217	24269896	-		○
	750	32	34	93 AU V168	TMP 21	24368224	-		○
	750	50	51,8	BHNBR B4B210	EK	24068701	-		○
	750	62,5	64,5	BHNBR B4B210	EK	24068702	-		○
	760	19,5	20	PTFE GM201	OMK-S	24149064	-		○
	760	19,5	20	PTFE GM201	OMK-S	49032525	-		○
	760	19,5	20	PTFE B602	OMK-S	49041153	-		○
	772	9	9,5	PTFE B602 / NBR	OMK-MR	24275523	IP		●
	772	9	9,5	PTFE GM201 / NBR	OMK-MR	24275645	-		○
	772	9	9,5	PTFE B602 / FKM	OMK-MR	24349473	-		○
	772,7	8,7	9,5	PTFE B602 / NBR	OMK-E	24276015	-		○
	772,7	8,7	9,5	PTFE GM201 / NBR	OMK-E	24276359	-		○
	772,7	8,7	9,5	PTFE B602 / FKM	OMK-E	24345192	-		○
	785	12,7	13	19YF / 80 A980	SPG	GS0520-V0	-	○	
805	777	9	9,5	PTFE B602 / NBR	OMK-MR	24344664	-		○
810	782	9	9,5	PTFE B602 / NBR	OMK-MR	24275513	-		○
	782	9	9,5	PTFE GM201 / NBR	OMK-MR	24275670	-		○
	782,7	8,7	9,5	PTFE B602 / NBR	OMK-E	24276017	-		○
	782,7	8,7	9,5	PTFE GM201 / NBR	OMK-E	24276361	-		○
	782,7	8,7	9,5	PTFE B602 / FKM	OMK-E	24345193	-		○
812,8	772,8	19,5	20	PTFE GM201	OMK-S	24250017	-		○
	784,8	9	9,5	PTFE B602 / NBR	OMK-MR	24351660	-		○
813	773	19,5	20	PTFE B602	OMK-S	49035171	-		○
820	780	19,5	20	PTFE GM201	OMK-S	24179588	-		○
	780	30,9	34	93 AU V168	TMP 21	49001226	-		○
	792	9	9,5	PTFE B602 / NBR	OMK-MR	24275504	-		○
	792	9	9,5	PTFE GM201 / NBR	OMK-MR	24275685	-		○
	792,7	8,7	9,5	PTFE B602 / NBR	OMK-E	24276019	-		○
	792,7	8,7	9,5	PTFE GM201 / NBR	OMK-E	24276362	-		○
	792,7	8,7	9,5	PTFE B602 / FKM	OMK-E	24345194	-		○
830	790	19,5	20	PTFE GM201	OMK-S	24224717	-		○
	802	9	9,5	PTFE B602 / NBR	OMK-MR	24275518	-		○
	802	9	9,5	PTFE GM201 / NBR	OMK-MR	24275673	-		○
	802	9	9,5	PTFE B602 / FKM	OMK-MR	24349476	-		○
	802	9	9,5	PTFE C104 / NBR	OMK-MR	49023951	-		○
	802,7	8,7	9,5	PTFE B602 / NBR	OMK-E	24276023	-		○
	802,7	8,7	9,5	PTFE GM201 / NBR	OMK-E	24276365	-		○
	802,7	8,7	9,5	PTFE B602 / FKM	OMK-E	24345195	-		○
840	790	32	34	93 AU V168	TMP 21	49005726	-		○

D [mm]	d [mm]	H [mm]	L [mm]	Material	Design	Part No.	PU ¹⁾	US	EU
840	800	19,5	20	PTFE GM201	OMK-S	24194420	-		○
	800	40	41,5	BHNBR B4B210	EK	24220089	-		○
	800	50	51,8	BHNBR B4B210	EK	24220090	-		○
	812	9	9,5	PTFE B602 / NBR	OMK-MR	24275511	-		○
	812	9	9,5	PTFE GM201 / NBR	OMK-MR	24275687	-		○
	812	9	9,5	PTFE B602 / FKM	OMK-MR	24349477	-		○
	812,7	8,7	9,5	PTFE GM201 / NBR	OMK-E	24276344	-		○
	812,7	8,7	9,5	PTFE B602 / FKM	OMK-E	24345196	-		○
850	800	32	34	80 NBR B246	Seal Set 0215	24294586	-		○
	800	32	34	80 NBR B246	Seal Set 0217	24294582	-		○
	800	32	34	93 AU V168	TMP 21	24368225	-		○
	800	50	51,8	BHNBR B4B210	EK	24101686	-		○
	800	62,5	64,5	BHNBR B4B210	EK	24085823	-		○
	810	19,5	20	PTFE GM201	OMK-S	24193103	-		○
	810	19,5	20	PTFE B602	OMK-S	49043282	-		○
	822	9	9,5	PTFE B602 / NBR	OMK-MR	24275507	-		○
	822	9	9,5	PTFE GM201 / NBR	OMK-MR	24275652	-		○
	822	9	9,5	PTFE B602 / FKM	OMK-MR	24349478	-		○
	822,7	8,7	9,5	PTFE B602 / NBR	OMK-E	24275933	-		○
	822,7	8,7	9,5	PTFE GM201 / NBR	OMK-E	24276254	-		○
822,7	8,7	9,5	PTFE B602 / FKM	OMK-E	24345197	-		○	
855	815	19,5	20	PTFE GM201	OMK-S	24239928	-		○
860	810	62,5	64,5	BHNBR B4B210	EK	24249193	-		○
	832	9	9,5	PTFE B602 / NBR	OMK-MR	24275515	-		○
	832	9	9,5	PTFE GM201 / NBR	OMK-MR	24275648	-		○
	832	9	9,5	PTFE B602 / FKM	OMK-MR	24349479	-		○
	832,7	8,7	9,5	PTFE B602 / NBR	OMK-E	24275931	-		○
	832,7	8,7	9,5	PTFE GM201 / NBR	OMK-E	24276252	-		○
	832,7	8,7	9,5	PTFE B602 / FKM	OMK-E	24345198	-		○
865	837	9	9,5	PTFE B602 / FKM	OMK-MR	24353417	-		○
	837	9	9,5	PTFE B602 / NBR	OMK-MR	24353783	-		○
870	820	50	51,8	BHNBR B4B210	EK	24097782	-		○
	820	62,5	64,5	BHNBR B4B210	EK	24137668	-		○
	830	19,5	20	PTFE GM201	OMK-S	24358273	-		○
	842	9	9,5	PTFE B602 / NBR	OMK-MR	24275522	-		○
	842	9	9,5	PTFE GM201 / NBR	OMK-MR	24275651	-		○
	842	9	9,5	PTFE B602 / FKM	OMK-MR	24349480	-		○
	842,7	8,7	9,5	PTFE B602 / NBR	OMK-E	24275966	-		○
	842,7	8,7	9,5	PTFE GM201 / NBR	OMK-E	24276284	-		○
	842,7	8,7	9,5	PTFE B602 / FKM	OMK-E	24345199	-		○
876,3	836,3	19,5	20	PTFE GM201	OMK-S	24374117	-		○
880	840	19,5	20	PTFE GM201	OMK-S	24188752	-		○
	852	9	9,5	PTFE B602 / NBR	OMK-MR	24275519	-		○
	852	9	9,5	PTFE GM201 / NBR	OMK-MR	24275657	-		○
	852	9	9,5	PTFE B602 / FKM	OMK-MR	24349481	-		○
	852,7	8,7	9,5	PTFE B602 / NBR	OMK-E	24276016	-		○
	852,7	8,7	9,5	PTFE GM201 / NBR	OMK-E	24276360	-		○
	852,7	8,7	9,5	PTFE B602 / FKM	OMK-E	24345200	-		○
890	850	19,5	20	PTFE GM201	OMK-S	24192177	-		○
	850	40	41,5	BHNBR B4B210	EK	24143588	-		○

D [mm]	d [mm]	H [mm]	L [mm]	Material	Design	Part No.	PU ¹⁾	US	EU
890	850	50	51,8	BH-NBR B4B210	EK	24218572	-		○
	862	9	9,5	PTFE B602 / NBR	OMK-MR	24275509	-		○
	862	9	9,5	PTFE GM201 / NBR	OMK-MR	24275669	-		○
	862	9	9,5	PTFE B602 / FKM	OMK-MR	24349482	-		○
	862,7	8,7	9,5	PTFE B602 / NBR	OMK-E	24275988	-		○
	862,7	8,7	9,5	PTFE GM201 / NBR	OMK-E	24276334	-		○
	862,7	8,7	9,5	PTFE B602 / FKM	OMK-E	24345201	-		○
900	850	32	34	80 NBR B246	Seal Set 0215	24294442	-		○
	850	32	34	80 NBR B246	Seal Set 0217	24294445	-		○
	850	32	34	93 AU V168	TMP 21	24368226	-		○
	850	50	51,8	BH-NBR B4B210	EK	24181084	-		○
	850	62,5	64,5	BH-NBR B4B210	EK	24128505	-		○
	860	19,5	20	PTFE GM201	OMK-S	24140132	-		○
	870	24,5	25	19YF / 80 A980	SPG	GS0407V2	-	○	
	872	9	9,5	PTFE B602 / NBR	OMK-MR	24275521	-		○
	872	9	9,5	PTFE GM201 / NBR	OMK-MR	24275677	-		○
	872	9	9,5	PTFE B602 / FKM	OMK-MR	24349483	-		○
	872,7	8,7	9,5	PTFE B602 / NBR	OMK-E	24275946	-		○
872,7	8,7	9,5	PTFE GM201 / NBR	OMK-E	24276267	-		○	
872,7	8,7	9,5	PTFE B602 / FKM	OMK-E	24345202	-		○	
910	882	9	9,5	PTFE B602 / NBR	OMK-MR	24275516	-		○
	882	9	9,5	PTFE GM201 / NBR	OMK-MR	24275672	-		○
	882	9	9,5	PTFE B602 / FKM	OMK-MR	24349484	-		○
	882,7	8,7	9,5	PTFE B602 / NBR	OMK-E	24275982	-		○
	882,7	8,7	9,5	PTFE GM201 / NBR	OMK-E	24276300	-		○
	882,7	8,7	9,5	PTFE B602 / FKM	OMK-E	24345203	-		○
914,4	874,4	19,5	20	PTFE GM201	OMK-S	24236377	-		○
914,5	887,2	8,7	9,5	PTFE B602 / NBR	OMK-E	24354427	-		○
915	875	19,5	20	PTFE C104	OMK-S	49021144	-		○
920	880	19,5	20	PTFE GM201	OMK-S	24224723	-		○
	892	9	9,5	PTFE B602 / NBR	OMK-MR	24269457	-		○
	892	9	9,5	PTFE GM201 / NBR	OMK-MR	24275680	-		○
	892	9	9,5	PTFE B602 / FKM	OMK-MR	24349485	-		○
	892,7	8,7	9,5	PTFE B602 / NBR	OMK-E	24275980	-		○
	892,7	8,7	9,5	PTFE GM201 / NBR	OMK-E	24276298	-		○
	892,7	8,7	9,5	PTFE B602 / FKM	OMK-E	24345204	-		○
930	890	19	20	19YF / 80 A980	SPG	GS0466V1	-	○	
	890	19,5	20	PTFE GM201	OMK-S	49011296	-		○
	902	9	9,5	PTFE B602 / NBR	OMK-MR	24275520	-		○
	902	9	9,5	PTFE GM201 / NBR	OMK-MR	24275653	-		○
	902	9	9,5	PTFE B602 / FKM	OMK-MR	24349486	-		○
	902,7	8,7	9,5	PTFE B602 / NBR	OMK-E	24275978	-		○
	902,7	8,7	9,5	PTFE GM201 / NBR	OMK-E	24276296	-		○
902,7	8,7	9,5	PTFE B602 / FKM	OMK-E	24345205	-		○	
935	920	12,7	13	19YF / 80 A980	SPG	GS0521V0	-	○	
940	900	19,5	20	PTFE GM201	OMK-S	24234404	-		○
	912	9	9,5	PTFE B602 / NBR	OMK-MR	24275524	-		○
	912	9	9,5	PTFE GM201 / NBR	OMK-MR	24275686	-		○
	912	9	9,5	PTFE B602 / FKM	OMK-MR	24349487	-		○
	912,7	8,7	9,5	PTFE B602 / NBR	OMK-E	24275928	-		○

D [mm]	d [mm]	H [mm]	L [mm]	Material	Design	Part No.	PU ¹⁾	US	EU
940	912,7	8,7	9,5	PTFE GM201 / NBR	OMK-E	24276249	-		○
	912,7	8,7	9,5	PTFE B602 / FKM	OMK-E	24345206	-		○
950	900	30,9	34	93 AU V168	TM 21	24368191	-		○
	900	32	34	80 NBR B246	Seal Set 0217	24295008	-		○
	900	32	34	93 AU V168	TMP 21	24368227	-		○
	900	62,5	64,5	BHNBR B4B210	EK	24081584	-		○
	910	19,5	20	PTFE GM201	OMK-S	24224728	-		○
	922	9	9,5	PTFE B602 / NBR	OMK-MR	24275525	-		○
	922	9	9,5	PTFE GM201 / NBR	OMK-MR	24275638	-		○
	922	9	9,5	PTFE B602 / FKM	OMK-MR	24349488	-		○
	922,7	8,7	9,5	PTFE B670 / NBR	OMK-E	24275976	-		○
	922,7	8,7	9,5	PTFE GM201 / NBR	OMK-E	24276294	-		○
	922,7	8,7	9,5	PTFE B602 / FKM	OMK-E	24345207	-		○
925	17,7	18	19YF / 80 A980	SPG	GS0285-V2	-	○		
952,5	912,5	19,5	20	PTFE GM201	OMK-S	24236527	-		○
	912,5	19,5	20	PTFE B670	OMK-S	24338734	-		○
964	924	19,5	20	PTFE GM201	OMK-S	49022358	-		○
965	925	19,5	20	PTFE GM201	OMK-S	24128975	IP		●
970	942	9	9,5	PTFE B602 / NBR	OMK-MR	531898	-		○
980	940	19,5	20	PTFE GM201	OMK-S	24224716	-		○
1000	950	32	34	80 NBR B246	Seal Set 0217	24269897	-		○
	950	32	34	93 AU V168	TMP 21	24368228	-		○
	950	50	51,8	BHNBR B4B210	EK	24068742	-		○
	950	62,5	64,5	BHNBR B4B210	EK	24068704	-		○
	960	19,5	20	PTFE B602	OMK-S	49011614	-		○
	960	19,5	20	PTFE C104	OMK-S	49021481	-		○
	960	19,7	20	19YF / 60 A402	SPG	GS0512-V0	-	○	
1014	974	19,5	20	PTFE GM201	OMK-S	49002346	-		○
1050	1000	50	51,8	BHNBR B4B210	EK	24311917	-		○
	1000	62,5	64,5	BHNBR B4B210	EK	24069614	-		○
	1010	19,5	20	PTFE GM201	OMK-S	24209083	-		○
	1010	19,5	20	PTFE GM201	OMK-S	24343584	IP		●
	1010	19,5	20	PTFE B602	OMK-S	49043259	-		○
1060	1000	40	42	80 NBR B246	Seal Set 0217	24297224	-		○
	1000	40	42,5	93 AU V168	TMP 21	24368050	-		○
	1020	19,5	20	PTFE B602	OMK-S	49002539	-		○
	1020	19,7	20	19YF / 60 A402	SPG	GS0587-V0	-	○	
1090	1050	19,5	20	PTFE GM201	OMK-S	530622	-		○
1100	1050	62,5	64,5	BHNBR B4B210	EK	24133469	-		○
	1060	19,5	20	PTFE GM201	OMK-S	24217067	-		○
	1060	19,5	20	PTFE B670	OMK-S	24373026	-		○
	1072	9	9,5	PTFE GM201 / NBR	OMK-MR	24345602	-		○
	1060	40	42,5	93 AU V168	TMP 21	24368229	-		○
1120	1080	19,5	20	PTFE GM201	OMK-S	24224715	-		○
	1080	19,7	20	19YF / 60 A402	SPG	GS0584-V0	-	○	
1140	1100	19,5	20	PTFE GM270	OMK-S	24182638	-		○
1150	1110	19,7	20	19YF / 60 A402	SPG	GS3007-V0	-	○	
1160	1110	31,9	35	93 AU V168	TM 21	24359833	-		○
	1120	19,5	20	PTFE GM201	OMK-S	49002143	-		○
1180	1120	40	42,5	93 AU V168	TMP 21	24367969	-		○

D [mm]	d [mm]	H [mm]	L [mm]	Material	Design	Part No.	PU ¹⁾	US	EU
1180	1130	19,7	20	19YF / 60 A402	SPG	GS0599-V1	-	○	
	1140	19,5	20	PTFE GM270	OMK-S	24361419	-		○
1200	1160	19,5	20	PTFE GM201	OMK-S	49036180	-		○
1210	1170	19	20	19YF / 60 A402	SPG	GS0465-V0	-	○	
1240	1180	40	42,5	93 AU V168	TMP 21	24367640	-		○
1250	1210	19,7	20	19YF / 60 A402	SPG	GS0281-V1	-	○	
1260	1220	19,7	20	19YF / 60 A402	SPG	GS0851-V0	-	○	
1330	1302	9	9,5	PTFE GM201 / NBR	OMK-MR	49005144	-		○
1400	1350	19,7	20	19YF / 60 A402	SPG	GS0402-V0	-	○	
1500	1460	19,7	20	19YF / 60 A402	SPG	GS0852-V0	-	○	
1650	1600	24	25	19YF / 60 A402	SPG	GS0579-V0	-	○	
1750	1710	19,5	20	PTFE GM202	OMK-S	24335493	-		○

Type	PI		Poly Hone 1704	DISO PAC	VCT		SYM	LSU
Standard	AS		AS	AS	AS		AS	AS
Shape								
Compound	Polyurethan 92 AU 9250	Polyurethan 94 AU 30000	Hytral HAT 2022	Polyurethan / NBR 98 AU 928 / NBR	PTFE / NBR 150 / 80 NBR	PTFE / FKM 150 / 80 FKM	Polyurethan 92 AU 9250	Polyurethan / NBR 93 AU 2093 N3101
Applications								

Bitte beachten Sie unsere allgemeinen Konstruktionshinweise in → Technisches Handbuch
 Daha detaylı montaj bilgisi için → Bkz. Technical Manual
 W celu zaznajomienia się z ogólnymi uwagami proszę skorzystać z Instrukcji
 Общие технические рекомендации см. → Техническое руководство

KOLBEN- UND SYMMETRISCHE DICHTUNGEN | PISTON VE SIMETRIK SIZDIRMAZLIK ELEMANLARI USZCZELNIENIA TŁOKA ORAZ SYMETRYCZNE | ПОРШНЕВЫЕ И СИММЕТРИЧНЫЕ УПЛОТНЕНИЯ

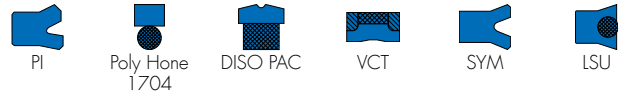
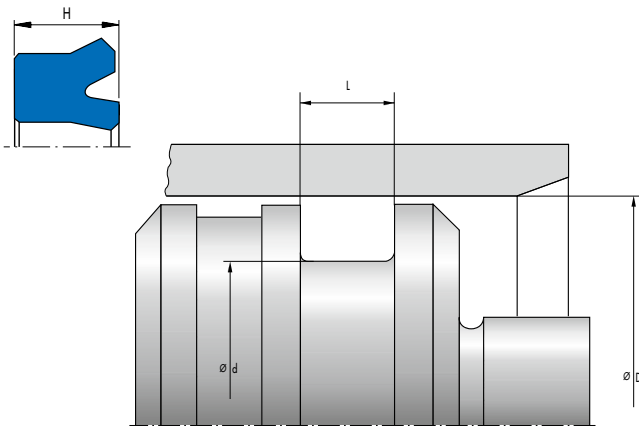

Wenn Sie Ihre Dichtung nicht finden können – Ihre Lösung auf Seite 12
 Aradığınız ürünü bulamadığınız takdirde – çözümünüzü sayfa 12
 Jeżeli nie możecie Państwo znaleźć uszczelki – rozwiązanie znajduje się na stronie 12
 Вы не можете подобрать необходимое уплотнение? – Решение на странице 12

1) IP = Industriepackung | Endüstriyel ambalaj | Opakowania przemysłowe | Производственная тара
 SP = Einzelpackung | Tek bir Paketi | Pojedyncze opakowanie | Single Pack

● Auf Lager | Stoklarda mevcuttur | Dostępne w magazynie | Имеется в наличии на складе
 ○ Auf Anfrage | Talep üzerine | Na zapytanie | По запросу

D [inch]	d [inch]	H [inch]	L [inch]	Material	Design	Part No.	PU ¹⁾	US	EU
0,375	0,125	0,125	0,156	92 AU 9250	SYM	5600050030D0A	–	●	
	0,125	0,188	0,218	92 AU 9250	SYM	5600050020D0A	–	○	
	0,125	0,25	0,275	93 AU 2093/N3101	LSU	12500125250B-2093	–	○	
0,437	0,125	0,25	0,281	92 AU 9250	SYM	5600050010D0A	–	○	
	0,187	0,125	0,138	93 AU 2093/N3101	LSU	12500187SQB-2093	–	○	
0,438	0,188	0,125	0,138	93 AU 2093/N3101	LSU	12500187-2093	–	○	
	0,188	0,125	0,156	92 AU 9250	SYM	5600050060D0A	–	●	
	0,188	0,188	0,218	92 AU 9250	SYM	5600050050D0A	–	●	
	0,188	0,25	0,275	93 AU 2093/N3101	LSU	12500187250B-2093	–	●	
0,5	0,188	0,25	0,281	92 AU 9250	SYM	5600050040D0A	–	●	
	0,25	0,125	0,138	93 AU 2093/N3101	LSU	12500250-2093	–	●	
	0,25	0,125	0,138	93 AU 2093/N3101	LSU	12500250SQB-2093	–	○	
	0,25	0,125	0,156	92 AU 9250	SYM	5600050090D0A	–	●	
	0,25	0,125	0,156	92 AU 9250	SYM	5600050090S0A	–	○	
	0,25	0,188	0,207	93 AU 2093/N3101	LSU	12500250187B-2093	–	○	
	0,25	0,188	0,218	92 AU 9250	SYM	5600050080D0A	–	●	
	0,25	0,25	0,275	93 AU 2093/N3101	LSU	12500250250B-2093	–	○	
0,562	0,25	0,25	0,281	92 AU 9250	SYM	5600050070D0A	–	●	
	0,187	0,188	0,207	93 AU 2093/N3101	LSU	18700187-2093	–	●	
	0,312	0,125	0,138	93 AU 2093/N3101	LSU	12500312SQB-2093	–	○	
	0,312	0,145	0,156	92 AU 9250	SYM	560005018Y00A	–	○	
0,563	0,312	0,25	0,275	93 AU 2093/N3101	LSU	12500312250B-2093	–	○	
	0,313	0,125	0,138	93 AU 2093/N3101	LSU	12500312-2093	–	●	
	0,313	0,125	0,156	92 AU 9250	SYM	5600050180D0A	–	●	
	0,313	0,125	0,156	92 AU 9250	SYM	5600050180S0A	–	●	
	0,313	0,188	0,218	92 AU 9250	SYM	5600050170D0A	–	●	
	0,313	0,25	0,281	92 AU 9250	SYM	5600050160D0A	–	●	
0,625	0,313	0,25	0,281	92 AU 9250	SYM	5600050160S0A	–	○	
	0,25	0,188	0,218	92 AU 9250	SYM	560005012000A	–	●	
	0,25	0,25	0,281	92 AU 9250	SYM	560005011000A	–	●	

D [inch]	d [inch]	H [inch]	L [inch]	Material	Design	Part No.	PU ¹⁾	US	EU
0,625	0,25	0,313	0,343	92 AU 9250	SYM	560005010000A	-	○	
	0,375	0,125	0,138	93 AU 2093/N3101	LSU	12500375-2093	-	●	
	0,375	0,125	0,156	92 AU 9250	SYM	5600050240D0A	-	●	
	0,375	0,125	0,156	92 AU 9250	SYM	5600050240S0A	-	●	
	0,375	0,188	0,207	93 AU 2093/N3101	LSU	12500375187B-2093	-	●	
	0,375	0,188	0,218	92 AU 9250	SYM	5600050230D0A	-	●	
	0,375	0,188	0,218	92 AU 9250	SYM	5600050230S0A	-	○	
	0,375	0,25	0,275	93 AU 2093/N3101	LSU	12500375250B-2093	-	○	
	0,375	0,25	0,281	92 AU 9250	SYM	5600050220D0A	-	●	
	0,375	0,25	0,281	92 AU 9250	SYM	5600050220S0A	-	●	
0,688	0,313	0,188	0,207	93 AU 2093/N3101	LSU	18700312-2093	-	○	
	0,313	0,313	0,344	93 AU 2093/N3101	LSU	18700312312B-2093	-	○	
	0,438	0,125	0,138	93 AU 2093/N3101	LSU	12500437-2093	-	○	
	0,438	0,125	0,156	92 AU 9250	SYM	560005033000A	-	○	
	0,438	0,125	0,156	92 AU 9250	SYM	5600050330D0A	-	●	
	0,438	0,188	0,218	92 AU 9250	SYM	5600050320D0A	-	○	
	0,438	0,188	0,218	92 AU 9250	SYM	5600050320S0A	-	○	
	0,438	0,25	0,275	93 AU 2093/N3101	LSU	12500437250B-2093	-	○	
0,438	0,25	0,281	92 AU 9250	SYM	5600050310D0A	-	●		
0,75	0,25	0,25	0,275	93 AU 2093/N3101	LSU	25000250-2093	-	○	
	0,25	0,313	0,343	92 AU 9250	SYM	560005014000A	-	○	
	0,25	0,375	0,406	92 AU 9250	SYM	560005013000A	-	○	
	0,375	0,188	0,207	93 AU 2093/N3101	LSU	18700375-2093	-	●	
	0,375	0,188	0,218	92 AU 9250	SYM	560005027000A	-	○	
	0,375	0,25	0,281	92 AU 9250	SYM	560005026000A	-	●	
	0,375	0,313	0,343	92 AU 9250	SYM	560005025000A	-	●	
	0,375	0,313	0,344	93 AU 2093/N3101	LSU	18700375312B-2093	-	○	
	0,5	0,125	0,138	93 AU 2093/N3101	LSU	12500500-2093	-	●	
	0,5	0,125	0,156	92 AU 9250	SYM	5600050360D0A	-	●	
	0,5	0,125	0,156	92 AU 9250	SYM	5600050360D0A+H	-	●	
	0,5	0,188	0,218	92 AU 9250	SYM	5600050350D0A	-	●	
	0,5	0,25	0,281	92 AU 9250	SYM	5600050340D0A	-	●	
0,5	0,25	0,281	92 AU 9250	SYM	5600050340S0A	-	●		
0,812	0,437	0,188	0,207	93 AU 2093/N3101	LSU	18700437-2093	-	●	
	0,562	0,125	0,138	93 AU 2093/N3101	LSU	12500562SQB-2093	-	○	
0,813	0,313	0,25	0,281	92 AU 9250	SYM	560005021000A	-	○	
	0,438	0,313	0,344	93 AU 2093/N3101	LSU	18700437312B-2093	-	○	
	0,563	0,125	0,156	92 AU 9250	SYM	5600050450D0A	-	●	
	0,563	0,188	0,218	92 AU 9250	SYM	5600050440D0A	-	○	
	0,563	0,25	0,275	93 AU 2093/N3101	LSU	12500562250B-2093	-	○	
	0,563	0,25	0,281	92 AU 9250	SYM	5600050430D0A	-	○	
0,875	0,375	0,25	0,281	92 AU 9250	SYM	560005030000A	-	○	
	0,375	0,313	0,343	92 AU 9250	SYM	560005029000A	-	○	
	0,375	0,375	0,406	92 AU 9250	SYM	5600050280D0A	-	○	
	0,5	0,188	0,207	93 AU 2093/N3101	LSU	18700500-2093	-	○	
	0,5	0,188	0,207	93 AU 2093/N3101	LSU	18700500SQB-2093	-	○	
	0,5	0,188	0,218	92 AU 9250	SYM	560005039000A	-	●	
	0,5	0,25	0,281	92 AU 9250	SYM	560005038000A	-	○	
	0,5	0,313	0,343	92 AU 9250	SYM	560005037000A	-	●	
	0,625	0,125	0,138	93 AU 2093/N3101	LSU	12500625-2093	-	●	

D [inch]	d [inch]	H [inch]	L [inch]	Material	Design	Part No.	PU ¹⁾	US	EU
0,875	0,625	0,125	0,138	93 AU 2093 /N3101	LSU	125006255QB-2093	-	●	
	0,625	0,125	0,156	92 AU 9250	SYM	5600050540D0A	-	●	
	0,625	0,14	0,156	92 AU 9250	SYM	560005054ZD0A	-	○	
	0,625	0,188	0,207	93 AU 2093 /N3101	LSU	12500625187-2093	-	●	
	0,625	0,188	0,207	93 AU 2093 /N3101	LSU	12500625187B-2093	-	●	
	0,625	0,188	0,218	92 AU 9250	SYM	5600050530D0A	-	●	
	0,625	0,25	0,281	92 AU 9250	SYM	5600050520D0A	-	●	
0,937	0,562	0,188	0,207	93 AU 2093 /N3101	LSU	18700562-2093	-	○	
	0,687	0,25	0,275	93 AU 2093 /N3101	LSU	12500687250B-2093	-	●	
0,938	0,438	0,25	0,275	93 AU 2093 /N3101	LSU	25000437-2093	-	○	
	0,438	0,375	0,413	93 AU 2093 /N3101	LSU	25000437375B-2093	-	○	
	0,563	0,188	0,218	92 AU 9250	SYM	560005048000A	-	○	
	0,563	0,188	0,218	92 AU 9250	SYM	5600050480D0A	-	○	
	0,563	0,25	0,281	92 AU 9250	SYM	560005047000A	-	○	
	0,563	0,313	0,343	92 AU 9250	SYM	560005046000A	-	○	
	0,563	0,313	0,344	93 AU 2093 /N3101	LSU	18700562312B-2093	-	○	
	0,688	0,125	0,138	93 AU 2093 /N3101	LSU	12500687-2093	-	○	
1	0,375	0,313	0,344	93 AU 2093 /N3101	LSU	31200375-2093	-	○	
	0,498	0,357	0,392	92 AU 9250	SYM	560005040Y00A	-	●	
	0,5	0,25	0,275	93 AU 2093 /N3101	LSU	25000500-2093	-	●	
	0,5	0,25	0,275	93 AU 2093 /N3101	LSU	250005005QB-2093	-	○	
	0,5	0,25	0,281	92 AU 9250	SYM	560005042000A	-	●	
	0,5	0,375	0,406	92 AU 9250	SYM	560005040000A	-	○	
	0,5	0,375	0,413	93 AU 2093 /N3101	LSU	25000500375-2093	-	○	
	0,625	0,188	0,207	93 AU 2093 /N3101	LSU	18700625-2093	-	●	
	0,625	0,188	0,207	93 AU 2093 /N3101	LSU	187006255QB-2093	-	○	
	0,625	0,188	0,218	92 AU 9250	PI	560002032000A	-	○	
	0,625	0,188	0,218	92 AU 9250	SYM	560005057000A	-	●	
	0,625	0,25	0,281	92 AU 9250	SYM	560005056000A	-	●	
	0,625	0,313	0,343	92 AU 9250	SYM	560005055000A	-	●	
	0,625	0,313	0,344	93 AU 2093 /N3101	LSU	18700625312B-2093	-	○	
	0,722	0,275	0,295	80L-150-98	VCT	56VCT016-708	-	○	
	0,741	0,07	0,083	HT 2022	PolyHone 1704	561704-016	-	○	
	0,741	0,07	0,083	HT 2055	PolyHone 1704	561704-016-2055	-	○	
	0,75	0,125	0,138	93 AU 2093 /N3101	LSU	12500750-2093	-	○	
	0,75	0,125	0,138	93 AU 2093 /N3101	LSU	125007505QB-2093	-	○	
	0,75	0,125	0,156	92 AU 9250	PI	560002035000A	-	●	
	0,75	0,125	0,156	92 AU 9250	SYM	5600050700D0A	-	●	
	0,75	0,16	0,218	92 AU 9250	SYM	560005068ZD0A	-	○	
	0,75	0,187	0,218	92 AU 9250	PI	560002034000A	-	○	
	0,75	0,188	0,207	93 AU 2093 /N3101	LSU	12500750187-2093	-	○	
	0,75	0,188	0,207	93 AU 2093 /N3101	LSU	12500750187B-2093	-	●	
	0,75	0,188	0,218	92 AU 9250	SYM	5600050690D0A	-	●	
	0,75	0,25	0,275	93 AU 2093 /N3101	LSU	12500750250-2093	-	○	
	0,75	0,25	0,275	93 AU 2093 /N3101	LSU	12500750250B-2093	-	○	
	0,75	0,25	0,281	92 AU 9250	PI	560002033000A	-	●	
	0,75	0,25	0,281	92 AU 9250	SYM	5600050680D0A	-	●	
	0,75	0,25	0,281	92 AU 9250	SYM	5600050680S0A	-	○	
	0,758	0,157	0,187	98 AU 928 /NBR	DISO-PAC	302-210-0001	-	●	
1,062	0,687	0,188	0,207	93 AU 2093 /N3101	LSU	18700687-2093	-	○	

D [inch]	d [inch]	H [inch]	L [inch]	Material	Design	Part No.	PU ¹⁾	US	EU
1,063	0,563	0,25	0,275	93 AU 2093 /N3101	LSU	25000562-2093	-	○	
	0,813	0,125	0,138	93 AU 2093 /N3101	LSU	12500812-2093	-	○	
	0,813	0,125	0,156	92 AU 9250	SYM	5600050790D0A	-	○	
	0,813	0,25	0,275	93 AU 2093 /N3101	LSU	12500812250B-2093	-	○	
	0,813	0,25	0,281	92 AU 9250	SYM	5600050770D0A	-	○	
1,125	0,5	0,313	0,344	93 AU 2093 /N3101	LSU	31200500-2093	-	○	
	0,625	0,25	0,275	93 AU 2093 /N3101	LSU	25000625-2093	-	●	
	0,625	0,25	0,281	92 AU 9250	SYM	560005060000A	-	●	
	0,625	0,375	0,406	92 AU 9250	SYM	560005058000A	-	●	
	0,625	0,375	0,413	93 AU 2093 /N3101	LSU	25000625375B-2093	-	○	
	0,75	0,156	0,172	93 AU 2093 /N3101	LSU	15600750-2093	-	○	
	0,75	0,188	0,207	93 AU 2093 /N3101	LSU	18700750-2093	-	●	
	0,75	0,188	0,207	93 AU 2093 /N3101	LSU	18700750SQB-2093	-	○	
	0,75	0,188	0,218	92 AU 9250	SYM	560005073000A	-	●	
	0,75	0,25	0,275	93 AU 2093 /N3101	LSU	18700750250B-2093	-	○	
	0,75	0,25	0,281	92 AU 9250	PI	560002043000A	-	○	
	0,75	0,25	0,281	92 AU 9250	SYM	560005072000A	-	●	
	0,75	0,313	0,343	92 AU 9250	SYM	560005071000A	-	○	
	0,75	0,313	0,344	93 AU 2093 /N3101	LSU	18700750312B-2093	-	○	
	0,866	0,07	0,083	HT 2022	PolyHone 1704	561704-018	-	○	
	0,875	0,125	0,138	93 AU 2093 /N3101	LSU	12500875-2093	-	○	
	0,875	0,125	0,138	93 AU 2093 /N3101	LSU	12500875SQB-2093	-	○	
	0,875	0,125	0,156	92 AU 9250	SYM	5600050880D0A	-	●	
	0,875	0,172	0,187	92 AU 9250	SYM	560005086ZD0A	-	●	
	0,875	0,188	0,207	93 AU 2093 /N3101	LSU	12500875187B-2093	-	●	
0,875	0,188	0,218	92 AU 9250	SYM	5600050870D0A	-	●		
0,875	0,25	0,275	93 AU 2093 /N3101	LSU	12500875250-2093	-	○		
0,875	0,25	0,275	93 AU 2093 /N3101	LSU	12500875250B-2093	-	○		
0,875	0,25	0,281	92 AU 9250	PI	560002045000A	-	○		
0,875	0,25	0,281	92 AU 9250	SYM	5600050860D0A	-	●		
0,875	0,25	0,281	92 AU 9250	SYM	5600050860S0A	-	●		
1,187	0,937	0,16	0,202	92 AU 9250	SYM	560005096ZD0A	-	○	
1,188	0,688	0,25	0,275	93 AU 2093 /N3101	LSU	25000687-2093	-	○	
	0,688	0,25	0,281	92 AU 9250	SYM	560005067000A	-	○	
	0,688	0,375	0,406	92 AU 9250	SYM	560005065000A	-	●	
	0,813	0,188	0,207	93 AU 2093 /N3101	LSU	18700812-2093	-	○	
	0,813	0,25	0,281	92 AU 9250	PI	560002049000A	-	●	
	0,813	0,25	0,281	92 AU 9250	SYM	560005081000A	-	○	
	0,938	0,125	0,138	93 AU 2093 /N3101	LSU	12500937-2093	-	○	
	0,938	0,125	0,156	92 AU 9250	SYM	5600050970D0A	-	●	
	0,938	0,188	0,218	92 AU 9250	SYM	5600050960D0A	-	○	
	0,938	0,25	0,275	93 AU 2093 /N3101	LSU	12500937250B-2093	-	○	
0,938	0,25	0,281	92 AU 9250	SYM	5600050950D0A	-	○		
1,25	0,75	0,25	0,275	93 AU 2093 /N3101	LSU	25000750-2093	-	●	
	0,75	0,25	0,275	93 AU 2093 /N3101	LSU	25000750SQB-2093	-	○	
	0,75	0,25	0,281	92 AU 9250	PI	560002056000A	-	○	
	0,75	0,25	0,281	92 AU 9250	SYM	560005076000A	-	●	
	0,75	0,375	0,406	92 AU 9250	SYM	560005074000A	-	○	
	0,75	0,375	0,413	93 AU 2093 /N3101	LSU	25000750375B-2093	-	○	
	0,752	0,275	0,295	80L-150-98	VCT	56VCT020-708	-	○	

D [inch]	d [inch]	H [inch]	L [inch]	Material	Design	Part No.	PU ¹⁾	US	EU
1,25	0,875	0,188	0,207	93 AU 2093 /N3101	LSU	18700875-2093	-	●	
	0,875	0,188	0,207	93 AU 2093 /N3101	LSU	18700875SQB-2093	-	○	
	0,875	0,188	0,218	92 AU 9250	PI	560002059000A	-	○	
	0,875	0,188	0,218	92 AU 9250	SYM	560005091000A	-	○	
	0,875	0,25	0,281	92 AU 9250	SYM	560005090000A	-	○	
	0,875	0,25	0,281	92 AU 9250	SYM	5600050900D0A	-	●	
	0,875	0,313	0,343	92 AU 9250	PI	560002057000A	-	○	
	0,875	0,313	0,343	92 AU 9250	SYM	560005089000A	-	●	
	0,875	0,313	0,344	93 AU 2093 /N3101	LSU	18700875312-2093	-	○	
	0,875	0,313	0,344	93 AU 2093 /N3101	LSU	18700875312B-2093	-	●	
	0,875	0,375	0,413	93 AU 2093 /N3101	LSU	18700875375-2093	-	○	
	0,991	0,07	0,083	HT 2022	PolyHone 1704	561704-020	-	○	
	0,991	0,07	0,083	HT 2055	PolyHone 1704	561704-020-2055	-	○	
	1	0,125	0,138	93 AU 2093 /N3101	LSU	12501000-2093	-	●	
	1	0,125	0,138	93 AU 2093 /N3101	LSU	12501000SQB-2093	-	○	
	1	0,125	0,156	92 AU 9250	PI	560002062000A	-	○	
	1	0,125	0,156	92 AU 9250	SYM	5600051060D0A	-	●	
	1	0,156	0,187	92 AU 9250	SYM	560005105BD0A	-	●	
	1	0,187	0,218	92 AU 9250	PI	560002061000A	-	○	
	1	0,188	0,207	93 AU 2093 /N3101	LSU	12501000187B-2093	-	●	
1	0,188	0,218	92 AU 9250	SYM	5600051050D0A	-	●		
1	0,25	0,275	93 AU 2093 /N3101	LSU	12501000250-2093	-	○		
1	0,25	0,275	93 AU 2093 /N3101	LSU	12501000250B-2093	-	●		
1	0,25	0,281	92 AU 9250	PI	560002060000A	-	●		
1	0,25	0,281	92 AU 9250	SYM	5600051040D0A	-	●		
1,008	0,157	0,187	98 AU 928 /NBR	DISO-PAC	302-214-0001	-	○		
1,312	1,062	0,125	0,138	93 AU 2093 /N3101	LSU	12501062SQB-2093	-	○	
1,313	0,688	0,313	0,344	93 AU 2093 /N3101	LSU	31200687-2093	-	○	
	0,813	0,25	0,281	92 AU 9250	SYM	560005085000A	-	○	
	0,813	0,375	0,406	92 AU 9250	SYM	560005083000A	-	○	
	0,938	0,188	0,218	92 AU 9250	SYM	560005100000A	-	●	
	0,938	0,313	0,343	92 AU 9250	SYM	005098000A	-	○	
	1,063	0,125	0,138	93 AU 2093 /N3101	LSU	12501062-2093	-	○	
	1,063	0,25	0,275	93 AU 2093 /N3101	LSU	12501062250B-2093	-	●	
1,375	0,75	0,313	0,344	93 AU 2093 /N3101	LSU	31200750-2093	-	○	
	0,75	0,5	0,55	93 AU 2093 /N3101	LSU	31200750500B-2093	-	○	
	0,875	0,25	0,275	93 AU 2093 /N3101	LSU	25000875-2093	-	●	
	0,875	0,25	0,275	93 AU 2093 /N3101	LSU	25000875SQB-2093	-	○	
	0,875	0,25	0,281	92 AU 9250	SYM	560005094000A	-	○	
	0,875	0,375	0,406	92 AU 9250	SYM	005092000A	-	○	
	0,875	0,375	0,413	93 AU 2093 /N3101	LSU	25000875375B-2093	-	○	
	1	0,156	0,172	93 AU 2093 /N3101	LSU	15601000SQB-2093	-	●	
	1	0,188	0,207	93 AU 2093 /N3101	LSU	15601000187B-2093	-	○	
	1	0,188	0,207	93 AU 2093 /N3101	LSU	18701000-2093	-	●	
	1	0,188	0,207	93 AU 2093 /N3101	LSU	18701000SQB-2093	-	●	
	1	0,188	0,218	92 AU 9250	SYM	560005109000A	-	●	
	1	0,25	0,275	93 AU 2093 /N3101	LSU	18701000250B-2093	-	●	
	1	0,25	0,281	92 AU 9250	SYM	560005108000A	-	●	
	1	0,313	0,343	92 AU 9250	SYM	560005107000A	-	●	
1	0,313	0,344	93 AU 2093 /N3101	LSU	18701000312-2093	-	○		

D [inch]	d [inch]	H [inch]	L [inch]	Material	Design	Part No.	PU ¹⁾	US	EU
	1	0,313	0,344	93 AU 2093 /N3101	LSU	18701000312B-2093	-	●	
	1	0,375	0,413	93 AU 2093 /N3101	LSU	18701000375B-2093	-	●	
	1,116	0,07	0,083	HT 2022	PolyHone 1704	561704-022	-	○	
	1,125	0,125	0,138	93 AU 2093 /N3101	LSU	12501125-2093	-	○	
	1,125	0,125	0,138	93 AU 2093 /N3101	LSU	12501125SQB-2093	-	●	
1,375	1,125	0,125	0,156	92 AU 9250	SYM	560005119AD0A	-	●	
	1,125	0,187	0,218	92 AU 9250	SYM	560005119CD0A	-	○	
	1,125	0,188	0,207	93 AU 2093 /N3101	LSU	12501125187B-2093	-	●	
	1,125	0,25	0,275	93 AU 2093 /N3101	LSU	12501125250-2093	-	○	
	1,125	0,25	0,275	93 AU 2093 /N3101	LSU	12501125250B-2093	-	○	
	1,125	0,25	0,281	92 AU 9250	SYM	5600051190D0A	-	●	
1,437	1,062	0,188	0,207	93 AU 2093 /N3101	LSU	18701062-2093	-	○	
	1,187	0,188	0,207	93 AU 2093 /N3101	LSU	12501187187B-2093	-	○	
	0,938	0,25	0,275	93 AU 2093 /N3101	LSU	25000937-2093	-	●	
1,438	0,938	0,25	0,281	92 AU 9250	SYM	005103000A	-	○	
	1,188	0,125	0,138	93 AU 2093 /N3101	LSU	12501187-2093	-	○	
	1,188	0,25	0,275	93 AU 2093 /N3101	LSU	12501187250B-2093	-	○	
	0,75	0,375	0,413	93 AU 2093 /N3101	LSU	37500750-2093	-	○	
	0,875	0,313	0,344	93 AU 2093 /N3101	LSU	31200875-2093	-	○	
	1	0,25	0,275	93 AU 2093 /N3101	LSU	25001000-2093	-	●	
	1	0,25	0,275	93 AU 2093 /N3101	LSU	25001000SQB-2093	-	○	
	1	0,25	0,281	92 AU 9250	PI	560002080000A	-	●	
	1	0,25	0,281	92 AU 9250	SYM	560005112000A	-	●	
	1	0,313	0,343	92 AU 9250	PI	560002079000A	-	○	
	1	0,313	0,343	92 AU 9250	SYM	560005111000A	-	○	
	1	0,35	0,392	92 AU 9250	PI	560002078Z00A	-	●	
	1	0,375	0,406	92 AU 9250	PI	560002078000A	-	●	
	1	0,375	0,406	92 AU 9250	SYM	560005110000A	-	●	
	1	0,375	0,413	93 AU 2093 /N3101	LSU	25001000375-2093	-	○	
	1	0,375	0,413	93 AU 2093 /N3101	LSU	25001000375B-2093	-	○	
	1,004	0,275	0,295	80L-150-98	VCT	56VCT024-708	-	○	
	1,125	0,188	0,207	93 AU 2093 /N3101	LSU	18701125-2093	-	●	
	1,125	0,188	0,218	92 AU 9250	SYM	560005120C00A	-	●	
1,5	1,125	0,25	0,275	93 AU 2093 /N3101	LSU	18701125250B-2093	-	●	
	1,125	0,25	0,281	92 AU 9250	PI	560002083000A	-	●	
	1,125	0,25	0,281	92 AU 9250	SYM	560005121000A	-	●	
	1,125	0,25	0,281	92 AU 9250	SYM	560005121Y00A	-	○	
	1,125	0,313	0,343	92 AU 9250	PI	560002082000A	-	●	
	1,125	0,313	0,343	92 AU 9250	SYM	560005120000A	-	●	
	1,125	0,313	0,344	93 AU 2093 /N3101	LSU	18701125312-2093	-	●	
	1,125	0,313	0,344	93 AU 2093 /N3101	LSU	18701125312B-2093	-	●	
	1,125	0,375	0,406	92 AU 9250	PI	560002081000A	-	○	
	1,125	0,375	0,413	93 AU 2093 /N3101	LSU	18701125375B-2093	-	○	
	1,241	0,07	0,083	HT 2022	PolyHone 1704	561704-024	-	○	
	1,241	0,07	0,083	HT 2055	PolyHone 1704	561704-024-2055	-	○	
	1,25	0,125	0,138	93 AU 2093 /N3101	LSU	12501250-2093	-	○	
	1,25	0,125	0,138	93 AU 2093 /N3101	LSU	12501250SQB-2093	-	○	
	1,25	0,135	0,156	92 AU 9250	SYM	560005132AD0A	-	●	
	1,25	0,156	0,188	92 AU 9250	SYM	560005132BD0A	-	●	
	1,25	0,187	0,218	92 AU 9250	SYM	560005132CD0A	-	●	

D [inch]	d [inch]	H [inch]	L [inch]	Material	Design	Part No.	PU ¹⁾	US	EU
1,5	1,25	0,188	0,207	93 AU 2093 /N3101	LSU	12501250187-2093	-	○	
	1,25	0,188	0,207	93 AU 2093 /N3101	LSU	12501250187B-2093	-	●	
	1,25	0,25	0,275	93 AU 2093 /N3101	LSU	12501250250B-2093	-	○	
	1,25	0,25	0,281	92 AU 9250	SYM	5600051320D0A	-	●	
	1,254	0,168	0,185	80L-155-95	VCT	56VCT-218-815	-	○	
	1,258	0,157	0,187	98 AU 928 /NBR	DISO-PAC	302-218-0001	-	●	
1,562	1,187	0,156	0,172	93 AU 2093 /N3101	LSU	15601187-2093	-	●	
	1,187	0,188	0,207	93 AU 2093 /N3101	LSU	18701187-2093	-	●	
	1,187	0,25	0,275	93 AU 2093 /N3101	LSU	18701187250B-2093	-	○	
	1,187	0,313	0,344	93 AU 2093 /N3101	LSU	18701187312B-2093	-	○	
	1,312	0,188	0,207	93 AU 2093 /N3101	LSU	12501312187B-2093	-	○	
	1,312	0,25	0,275	93 AU 2093 /N3101	LSU	12501312250B-2093	-	○	
1,563	1,188	0,313	0,343	92 AU 9250	SYM	560005127000A	-	○	
	1,313	0,125	0,138	93 AU 2093 /N3101	LSU	12501312-2093	-	○	
	1,313	0,25	0,281	92 AU 9250	SYM	0051440D0A	-	○	
1,625	1	0,313	0,344	93 AU 2093 /N3101	LSU	31201000-2093	-	○	
	1,125	0,25	0,275	93 AU 2093 /N3101	LSU	25001125-2093	-	○	
	1,125	0,25	0,281	92 AU 9250	PI	560002086000A	-	○	
	1,125	0,25	0,281	92 AU 9250	SYM	560005124000A	-	○	
	1,125	0,281	0,312	92 AU 9250	SYM	560005123F00A	-	○	
	1,125	0,313	0,343	92 AU 9250	PI	560002085000A	-	●	
	1,125	0,313	0,343	92 AU 9250	SYM	560005123000A	-	○	
	1,125	0,375	0,406	92 AU 9250	PI	560002084000A	-	○	
	1,125	0,375	0,406	92 AU 9250	SYM	005122000A	-	●	
	1,125	0,375	0,413	93 AU 2093 /N3101	LSU	25001125375B-2093	-	○	
	1,235	0,109	0,122	HT 2022	PolyHone 1704	561704-026	-	○	
	1,235	0,109	0,122	HT 2055	PolyHone 1704	561704-026-2055	-	○	
	1,25	0,187	0,218	92 AU 9250	SYM	560005133C00A	-	○	
	1,25	0,188	0,207	93 AU 2093 /N3101	LSU	18701250-2093	-	●	
	1,25	0,188	0,207	93 AU 2093 /N3101	LSU	18701250SQB-2093	-	○	
	1,25	0,25	0,275	93 AU 2093 /N3101	LSU	18701250250B-2093	-	○	
	1,25	0,25	0,281	92 AU 9250	PI	560002089000A	-	○	
	1,25	0,25	0,281	92 AU 9250	SYM	560005134000A	-	●	
	1,25	0,313	0,343	92 AU 9250	PI	560002088000A	-	○	
	1,25	0,313	0,343	92 AU 9250	SYM	560005133000A	-	●	
	1,25	0,313	0,344	93 AU 2093 /N3101	LSU	18701250312-2093	-	○	
	1,25	0,313	0,344	93 AU 2093 /N3101	LSU	18701250312B-2093	-	●	
	1,25	0,375	0,413	93 AU 2093 /N3101	LSU	18701250375B-2093	-	○	
	1,375	0,125	0,138	93 AU 2093 /N3101	LSU	12501375-2093	-	○	
1,375	0,125	0,138	93 AU 2093 /N3101	LSU	12501375SQB-2093	-	○		
1,375	0,188	0,207	93 AU 2093 /N3101	LSU	12501375187B-2093	-	●		
1,375	0,25	0,275	93 AU 2093 /N3101	LSU	12501375250-2093	-	●		
1,375	0,25	0,275	93 AU 2093 /N3101	LSU	12501375250B-2093	-	○		
1,375	0,25	0,281	92 AU 9250	SYM	5600051510D0A	-	○		
1,375	0,25	0,281	92 AU 9250	SYM	5600051510S0A	-	●		
1,687	1,187	0,25	0,275	93 AU 2093 /N3101	LSU	25001187SQB-2093	-	○	
1,688	1,188	0,25	0,275	93 AU 2093 /N3101	LSU	25001187-2093	-	○	
	1,188	0,25	0,281	92 AU 9250	SYM	5600051310D0A	-	●	
	1,188	0,313	0,343	92 AU 9250	SYM	560005130000A	-	●	
	1,188	0,375	0,413	93 AU 2093 /N3101	LSU	25001187375B-2093	-	○	

D [inch]	d [inch]	H [inch]	L [inch]	Material	Design	Part No.	PU ¹⁾	US	EU	
1,688	1,313	0,313	0,343	92 AU 9250	SYM	005145000A	-	○		
	1,313	0,313	0,344	93 AU 2093 /N3101	LSU	18701312312B-2093	-	○		
1,75	1	0,375	0,413	93 AU 2093 /N3101	LSU	37501000-2093	-	○		
	1,125	0,313	0,344	93 AU 2093 /N3101	LSU	31201125-2093	-	○		
	1,125	0,313	0,344	93 AU 2093 /N3101	LSU	31201125SQB-2093	-	○		
	1,125	0,375	0,413	93 AU 2093 /N3101	LSU	31201125375B-2093	-	○		
	1,125	0,438	0,468	92 AU 9250	PI	002091000A	-	●		
	1,125	0,5	0,531	92 AU 9250	PI	002090000A	-	○		
	1,25	0,25	0,275	93 AU 2093 /N3101	LSU	25001250-2093	-	●		
	1,25	0,25	0,275	93 AU 2093 /N3101	LSU	25001250SQB-2093	-	○		
	1,25	0,25	0,281	92 AU 9250	PI	560002095000A	-	●		
	1,25	0,25	0,281	92 AU 9250	SYM	560005137000A	-	●		
	1,25	0,313	0,343	92 AU 9250	SYM	560005136000A	-	●		
	1,25	0,375	0,406	92 AU 9250	PI	560002093000A	-	●		
	1,25	0,375	0,406	92 AU 9250	SYM	560005135000A	-	●		
	1,25	0,375	0,413	93 AU 2093 /N3101	LSU	25001250375B-2093	-	○		
	1,254	0,275	0,295	80L-150-98	VCT	56VCT028-708	-	●		
	1,36	0,109	0,122	HT 2022	PolyHone 1704	561704-028	-	○		
	1,36	0,109	0,122	HT 2055	PolyHone 1704	561704-028-2055	-	○		
	1,75	1,375	0,156	0,172	93 AU 2093 /N3101	LSU	15601375-2093	-	●	
		1,375	0,156	0,172	93 AU 2093 /N3101	LSU	15601375SQB-2093	-	○	
		1,375	0,188	0,207	93 AU 2093 /N3101	LSU	18701375-2093	-	○	
		1,375	0,188	0,207	93 AU 2093 /N3101	LSU	18701375SQB-2093	-	○	
		1,375	0,25	0,275	93 AU 2093 /N3101	LSU	18701375250B-2093	-	○	
		1,375	0,25	0,281	92 AU 9250	SYM	560005152E00A	-	●	
		1,375	0,313	0,343	92 AU 9250	PI	560002097000A	-	●	
		1,375	0,313	0,343	92 AU 9250	SYM	560005152000A	-	●	
		1,375	0,313	0,344	93 AU 2093 /N3101	LSU	18701375312-2093	-	○	
		1,375	0,313	0,344	93 AU 2093 /N3101	LSU	18701375312B-2093	-	○	
		1,375	0,375	0,406	92 AU 9250	PI	560002096000A	-	○	
		1,375	0,375	0,413	93 AU 2093 /N3101	LSU	18701375375B-2093	-	○	
		1,5	0,125	0,138	93 AU 2093 /N3101	LSU	12501500-2093	-	●	
		1,5	0,125	0,138	93 AU 2093 /N3101	LSU	12501500SQB-2093	-	○	
		1,5	0,188	0,207	93 AU 2093 /N3101	LSU	12501500187B-2093	-	○	
1,5		0,25	0,275	93 AU 2093 /N3101	LSU	12501500250-2093	-	○		
1,5		0,25	0,275	93 AU 2093 /N3101	LSU	12501500250B-2093	-	○		
1,5		0,25	0,281	92 AU 9250	SYM	5600051630D0A	-	●		
1,508	0,157	0,187	98 AU 928 /NBR	DISO-PAC	302-222-0001	-	●			
1,812	1,437	0,25	0,281	92 AU 9250	SYM	005159E00A	-	○		
1,813	1,313	0,375	0,406	92 AU 9250	SYM	560005146000A	-	○		
	1,313	0,375	0,413	93 AU 2093 /N3101	LSU	25001312375B-2093	-	○		
	1,438	0,313	0,343	92 AU 9250	SYM	005159000A	-	○		
	1,438	0,313	0,344	93 AU 2093 /N3101	LSU	18701437312B-2093	-	○		
1,875	1,25	0,312	0,343	92 AU 9250	SYM	560005138G00A	-	●		
	1,25	0,375	0,406	92 AU 9250	SYM	560005140000A	-	○		
	1,25	0,375	0,413	93 AU 2093 /N3101	LSU	31201250375B-2093	-	○		
	1,25	0,469	0,499	92 AU 9250	PI	560002099L00A	-	●		
	1,25	0,5	0,531	92 AU 9250	PI	560002099000A	-	○		
	1,25	0,5	0,531	92 AU 9250	SYM	560005138000A	-	○		
	1,375	0,25	0,275	93 AU 2093 /N3101	LSU	25001375-2093	-	●		

D [inch]	d [inch]	H [inch]	L [inch]	Material	Design	Part No.	PU ¹⁾	US	EU
	1,375	0,25	0,275	93 AU 2093 /N3101	LSU	25001375SQB-2093	-	○	
	1,375	0,25	0,281	92 AU 9250	PI	002104000A	-	●	
	1,375	0,25	0,281	92 AU 9250	SYM	560005153E00A	-	●	
	1,375	0,313	0,343	92 AU 9250	SYM	560005154000A	-	○	
	1,375	0,375	0,406	92 AU 9250	SYM	560005153000A	-	●	
	1,375	0,375	0,413	93 AU 2093 /N3101	LSU	25001375375-2093	-	○	
	1,375	0,375	0,413	93 AU 2093 /N3101	LSU	25001375375B-2093	-	●	
	1,485	0,109	0,122	HT 2022	PolyHone 1704	561704-030	-	○	
	1,485	0,109	0,122	HT 2055	PolyHone 1704	561704-030-2055	-	○	
	1,5	0,188	0,207	93 AU 2093 /N3101	LSU	18701500-2093	-	○	
	1,5	0,188	0,207	93 AU 2093 /N3101	LSU	18701500SQB-2093	-	●	
1,875	1,5	0,188	0,218	92 AU 9250	SYM	560005164C00A	-	●	
	1,5	0,25	0,275	93 AU 2093 /N3101	LSU	18701500250B-2093	-	●	
	1,5	0,25	0,281	92 AU 9250	SYM	560005164E00A	-	●	
	1,5	0,275	0,303	93 AU 2093 /N3101	LSU	18701500275B-2093	-	○	
	1,5	0,313	0,343	92 AU 9250	SYM	560005165000A	-	●	
	1,5	0,313	0,344	93 AU 2093 /N3101	LSU	15601500312B-2093	-	○	
	1,5	0,313	0,344	93 AU 2093 /N3101	LSU	18701500312-2093	-	○	
	1,5	0,313	0,344	93 AU 2093 /N3101	LSU	18701500312B-2093	-	○	
	1,5	0,375	0,406	92 AU 9250	SYM	560005164000A	-	●	
	1,5	0,375	0,413	93 AU 2093 /N3101	LSU	18701500375B-2093	-	○	
	1,505	0,25	0,281	98 AU 928 /NBR	DISO-PAC	302-325-0001	-	●	
	1,625	0,125	0,138	93 AU 2093 /N3101	LSU	12501625-2093	-	○	
1,938	1,313	0,313	0,344	93 AU 2093 /N3101	LSU	31201312-2093	-	○	
	1,563	0,188	0,207	93 AU 2093 /N3101	LSU	18701562-2093	-	○	
	1,25	0,375	0,406	92 AU 9250	SYM	005143000A	-	●	
	1,25	0,375	0,413	93 AU 2093 /N3101	LSU	37501250-2093	-	○	
	1,25	0,375	0,413	93 AU 2093 /N3101	LSU	37501250SQB-2093	-	○	
	1,25	0,5	0,531	92 AU 9250	SYM	005141000A	-	●	
	1,25	0,625	0,688	93 AU 2093 /N3101	LSU	37501250625-2093	-	○	
	1,25	0,625	0,688	93 AU 2093 /N3101	LSU	37501250625B-2093	-	○	
	1,375	0,312	0,343	92 AU 9250	SYM	560005155G00A	-	●	
	1,375	0,313	0,344	93 AU 2093 /N3101	LSU	31201375-2093	-	●	
	1,375	0,375	0,406	92 AU 9250	PI	560002109000A	-	●	
	1,375	0,375	0,406	92 AU 9250	SYM	560005157000A	-	●	
	1,375	0,375	0,413	93 AU 2093 /N3101	LSU	31201375375B-2093	-	○	
	1,375	0,438	0,468	92 AU 9250	PI	560002108000A	-	○	
2	1,375	0,5	0,531	92 AU 9250	PI	560002107000A	-	●	
	1,442	0,275	0,295	80L-150-98	VCT	56VCT032-808	-	●	
	1,5	0,25	0,275	93 AU 2093 /N3101	LSU	25001500-2093	-	○	
	1,5	0,25	0,275	93 AU 2093 /N3101	LSU	25001500SQB-2093	-	○	
	1,5	0,25	0,281	92 AU 9250	PI	560002110E00A	-	○	
	1,5	0,25	0,281	92 AU 9250	SYM	560005167E00A	-	●	
	1,5	0,313	0,343	92 AU 9250	PI	560002111000A	-	●	
	1,5	0,313	0,343	92 AU 9250	SYM	560005167000A	-	●	
	1,5	0,375	0,406	92 AU 9250	PI	560002110000A	-	●	
	1,5	0,375	0,406	92 AU 9250	SYM	560005166000A	-	●	
	1,5	0,375	0,413	93 AU 2093 /N3101	LSU	25001500375-2093	-	○	
	1,5	0,375	0,413	93 AU 2093 /N3101	LSU	25001500375B-2093	-	○	
	1,5	0,5	0,55	93 AU 2093 /N3101	LSU	25001500500B-2093	-	○	

D [inch]	d [inch]	H [inch]	L [inch]	Material	Design	Part No.	PU ¹⁾	US	EU	
2	1,606	0,115	0,13	HT 2022	PolyHone 1704	561704-032	-	●		
	1,606	0,115	0,13	HT 2055	PolyHone 1704	561704-032-2055	-	●		
	1,625	0,188	0,207	93 AU 2093 /N3101	LSU	18701625-2093	-	●		
	1,625	0,188	0,207	93 AU 2093 /N3101	LSU	18701625SQB-2093	-	●		
	1,625	0,25	0,275	93 AU 2093 /N3101	LSU	18701625250B-2093	-	●		
	1,625	0,25	0,281	92 AU 9250	SYM	560005174E00A	-	●		
	1,625	0,313	0,343	92 AU 9250	PI	560002113000A	-	●		
	1,625	0,313	0,343	92 AU 9250	SYM	560005175000A	-	●		
	1,625	0,313	0,344	93 AU 2093 /N3101	LSU	18701625312-2093	-	○		
	1,625	0,313	0,344	93 AU 2093 /N3101	LSU	18701625312B-2093	-	○		
	1,625	0,375	0,406	92 AU 9250	PI	560002112000A	-	●		
	1,625	0,375	0,406	92 AU 9250	SYM	560005174000A	-	●		
	1,625	0,375	0,413	93 AU 2093 /N3101	LSU	18701625375-2093	-	●		
	1,625	0,375	0,413	93 AU 2093 /N3101	LSU	18701625375B-2093	-	○		
	1,627	0,378	0,424	70L-155-95	VCT	56VCT-2000-715	-	●		
	1,63	0,25	0,281	98 AU 928 /NBR	DISO-PAC	302-326-0001	-	●		
	1,75	0,125	0,138	93 AU 2093 /N3101	LSU	12501750SQB-2093	-	○		
	1,75	0,188	0,207	93 AU 2093 /N3101	LSU	12501750187B-2093	-	○		
	1,75	0,25	0,275	93 AU 2093 /N3101	LSU	12501750250B-2093	-	○		
	2,063	1,688	0,188	0,207	93 AU 2093 /N3101	LSU	18701687-2093	-	○	
2,125	1,5	0,375	0,406	92 AU 9250	SYM	560005170000A	-	○		
	1,5	0,375	0,413	93 AU 2093 /N3101	LSU	31201500375B-2093	-	●		
	1,5	0,438	0,469	92 AU 9250	SYM	560005169000A	-	○		
	1,5	0,5	0,531	92 AU 9250	SYM	560005168000A	-	○		
	1,5	0,5	0,55	93 AU 2093 /N3101	LSU	31201500500B-2093	-	○		
	1,625	0,375	0,406	92 AU 9250	SYM	560005176000A	-	○		
	1,731	0,115	0,13	HT 2022	PolyHone 1704	561704-034	-	○		
	1,731	0,115	0,13	HT 2055	PolyHone 1704	561704-034-2055	-	○		
	1,75	0,188	0,207	93 AU 2093 /N3101	LSU	18701750-2093	-	○		
	1,75	0,188	0,207	93 AU 2093 /N3101	LSU	18701750SQB-2093	-	●		
	1,75	0,188	0,218	92 AU 9250	SYM	560005184CD0A	-	○		
	1,75	0,23	0,253	93 AU 2093 /N3101	LSU	18701750230B-2093	-	○		
	1,75	0,25	0,275	93 AU 2093 /N3101	LSU	18701750250-2093	-	○		
	1,75	0,25	0,275	93 AU 2093 /N3101	LSU	18701750250B-2093	-	○		
	1,75	0,25	0,281	92 AU 9250	SYM	560005184E00A	-	●		
	1,75	0,275	0,303	93 AU 2093 /N3101	LSU	18701750275B-2093	-	○		
	1,75	0,313	0,343	92 AU 9250	PI	560002120000A	-	○		
	1,75	0,313	0,343	92 AU 9250	SYM	560005185000A	-	○		
	1,75	0,313	0,344	93 AU 2093 /N3101	LSU	18701750312-2093	-	○		
	1,75	0,313	0,344	93 AU 2093 /N3101	LSU	18701750312B-2093	-	●		
	1,75	0,375	0,406	92 AU 9250	PI	560002119000A	-	●		
	1,75	0,375	0,406	92 AU 9250	SYM	560005184000A	-	●		
	1,75	0,375	0,413	93 AU 2093 /N3101	LSU	18701750375-2093	-	●		
	1,75	0,375	0,413	93 AU 2093 /N3101	LSU	18701750375B-2093	-	○		
	1,755	0,25	0,281	98 AU 928 /NBR	DISO-PAC	302-327-0001	-	○		
	1,875	0,125	0,138	93 AU 2093 /N3101	LSU	12501875-2093	-	○		
	2,25	1,5	0,375	0,406	92 AU 9250	SYM	560005173000A	-	○	
		1,5	0,375	0,413	93 AU 2093 /N3101	LSU	37501500-2093	-	○	
1,5		0,5	0,531	92 AU 9250	SYM	560005171000A	-	○		
1,625		0,312	0,343	92 AU 9250	SYM	005180G00A	-	○		

D [inch]	d [inch]	H [inch]	L [inch]	Material	Design	Part No.	PU ¹⁾	US	EU
2,25	1,625	0,313	0,344	93 AU 2093 /N3101	LSU	31201625-2093	-	○	
	1,625	0,375	0,406	92 AU 9250	PI	002123000A	-	○	
	1,625	0,375	0,406	92 AU 9250	SYM	560005180000A	-	●	
	1,625	0,375	0,413	93 AU 2093 /N3101	LSU	31201625375B-2093	-	○	
	1,625	0,5	0,531	92 AU 9250	PI	002121000A	-	○	
	1,692	0,275	0,295	80L-150-98	VCT	56VCT036-808	-	●	
	1,75	0,25	0,275	93 AU 2093 /N3101	LSU	25001750-2093	-	○	
	1,75	0,25	0,281	92 AU 9250	SYM	560005186E00A	-	●	
	1,75	0,312	0,343	92 AU 9250	SYM	560005187000A	-	○	
	1,75	0,313	0,343	92 AU 9250	PI	560002125000A	-	○	
	1,75	0,313	0,344	93 AU 2093 /N3101	LSU	25001750312B-2093	-	○	
	1,75	0,375	0,406	92 AU 9250	PI	560002124Y00A	-	○	
	1,75	0,375	0,406	92 AU 9250	PI	560002124000A	-	●	
	1,75	0,375	0,406	92 AU 9250	SYM	560005186000A	-	●	
	1,75	0,375	0,413	93 AU 2093 /N3101	LSU	25001750375-2093	-	●	
	1,75	0,375	0,413	93 AU 2093 /N3101	LSU	25001750375B-2093	-	○	
	1,856	0,115	0,13	HT 2022	PolyHone 1704	561704-036	-	●	
	1,856	0,115	0,13	HT 2055	PolyHone 1704	561704-036-2055	-	●	
	1,875	0,188	0,207	93 AU 2093 /N3101	LSU	18701875-2093	-	●	
	1,875	0,188	0,218	92 AU 9250	SYM	560005194C00A	-	●	
	1,875	0,25	0,275	93 AU 2093 /N3101	LSU	18701875250B-2093	-	○	
	1,875	0,313	0,343	92 AU 9250	SYM	560005195000A	-	●	
	1,875	0,313	0,344	93 AU 2093 /N3101	LSU	18701875312B-2093	-	○	
	1,875	0,375	0,406	92 AU 9250	SYM	560005194000A	-	●	
	1,875	0,375	0,413	93 AU 2093 /N3101	LSU	18701875375B-2093	-	○	
1,88	0,25	0,281	98 AU 928 /NBR	DISO-PAC	302-328-0001	-	●		
2	0,125	0,138	93 AU 2093 /N3101	LSU	12502000-2093	-	○		
2	0,25	0,275	93 AU 2093 /N3101	LSU	12502000250B-2093	-	○		
2,375	1,625	0,375	0,406	92 AU 9250	SYM	005183000A	-	○	
	1,625	0,375	0,413	93 AU 2093 /N3101	LSU	37501625-2093	-	○	
	1,625	0,5	0,531	92 AU 9250	SYM	005182000A	-	○	
	1,625	0,625	0,688	93 AU 2093 /N3101	LSU	37501625625B-2093	-	○	
	1,75	0,312	0,343	92 AU 9250	SYM	560005188G00A	-	○	
	1,75	0,313	0,344	93 AU 2093 /N3101	LSU	31201750-2093	-	○	
	1,75	0,375	0,406	92 AU 9250	SYM	005190000A	-	●	
	1,75	0,5	0,531	92 AU 9250	PI	002128000A	-	○	
	1,75	0,5	0,531	92 AU 9250	SYM	560005188000A	-	●	
	1,875	0,375	0,413	93 AU 2093 /N3101	LSU	25001875375B-2093	-	○	
	2	0,188	0,207	93 AU 2093 /N3101	LSU	18702000-2093	-	●	
	2	0,188	0,207	93 AU 2093 /N3101	LSU	18702000SQB-2093	-	●	
	2	0,25	0,275	93 AU 2093 /N3101	LSU	18702000250B-2093	-	●	
	2	0,25	0,281	92 AU 9250	SYM	560005202E00A	-	●	
	2	0,275	0,303	93 AU 2093 /N3101	LSU	18702000275B-2093	-	○	
	2	0,313	0,343	92 AU 9250	PI	560002134000A	-	●	
	2	0,313	0,343	92 AU 9250	SYM	560005203000A	-	●	
	2	0,313	0,344	93 AU 2093 /N3101	LSU	18702000312B-2093	-	○	
	2	0,375	0,406	92 AU 9250	PI	560002133000A	-	●	
	2	0,375	0,406	92 AU 9250	SYM	560005202000A	-	●	
2	0,375	0,413	93 AU 2093 /N3101	LSU	18702000375-2093	-	○		
2	0,375	0,413	93 AU 2093 /N3101	LSU	18702000375B-2093	-	●		

D [inch]	d [inch]	H [inch]	L [inch]	Material	Design	Part No.	PU ¹⁾	US	EU
2,375	2	0,375	0,413	93 AU 2093 /N3101	LSU	18702000375L-2093	-	○	
	2,125	0,25	0,275	93 AU 2093 /N3101	LSU	12502125250B-2093	-	●	
2,5	1,5	0,5	0,55	93 AU 2093 /N3101	LSU	50001500-2093	-	○	
	1,75	0,375	0,406	92 AU 9250	SYM	005193000A	-	○	
	1,75	0,375	0,413	93 AU 2093 /N3101	LSU	37501750-2093	-	○	
	1,75	0,5	0,531	92 AU 9250	SYM	005192000A	-	●	
	1,75	0,5	0,55	93 AU 2093 /N3101	LSU	37501750500B-2093	-	○	
	1,75	0,593	0,624	92 AU 9250	SYM	005191QB0A	-	○	
	1,75	0,625	0,656	92 AU 9250	SYM	005191000A	-	●	
	1,75	0,625	0,688	93 AU 2093 /N3101	LSU	37501750625B-2093	-	○	
	1,875	0,312	0,343	92 AU 9250	SYM	560005196G00A	-	●	
	1,875	0,313	0,344	93 AU 2093 /N3101	LSU	31201875-2093	-	○	
	1,875	0,375	0,406	92 AU 9250	PI	560002137000A	-	●	
	1,875	0,375	0,406	92 AU 9250	SYM	560005198000A	-	●	
	1,875	0,375	0,413	93 AU 2093 /N3101	LSU	31201875375B-2093	-	○	
	1,875	0,438	0,468	92 AU 9250	PI	560002136000A	-	○	
	1,875	0,5	0,531	92 AU 9250	PI	560002135000A	-	●	
	1,875	0,5	0,531	92 AU 9250	SYM	560005196000A	-	●	
	1,875	0,5	0,55	93 AU 2093 /N3101	LSU	31201875500-2093	-	○	
	1,884	0,25	0,288	98 AU 928 /NBR	DISO-PAC	302-330-0011	-	○	
	1,942	0,275	0,295	80L-150-98	VCT	56VCT040-808	-	●	
	2	0,25	0,275	93 AU 2093 /N3101	LSU	25002000-2093	-	○	
	2	0,25	0,275	93 AU 2093 /N3101	LSU	25002000SQB-2093	-	○	
	2	0,25	0,281	92 AU 9250	SYM	560005204ED0A	-	●	
	2	0,313	0,343	92 AU 9250	PI	560002139000A	-	○	
	2	0,313	0,344	93 AU 2093 /N3101	LSU	25002000312B-2093	-	●	
	2	0,375	0,406	92 AU 9250	PI	560002138000A	-	●	
	2	0,375	0,406	92 AU 9250	SYM	560005204000A	-	●	
	2	0,375	0,413	93 AU 2093 /N3101	LSU	25002000375-2093	-	○	
	2	0,375	0,413	93 AU 2093 /N3101	LSU	25002000375B-2093	-	●	
	2	0,5	0,55	93 AU 2093 /N3101	LSU	25002000500B-2093	-	○	
	2,106	0,115	0,13	HT 2055	PolyHone 1704	561704-040-2055	-	●	
	2,125	0,188	0,207	93 AU 2093 /N3101	LSU	18702125-2093	-	●	
	2,125	0,188	0,207	93 AU 2093 /N3101	LSU	18702125SQB-2093	-	○	
	2,125	0,188	0,218	92 AU 9250	PI	560002140C00A	-	●	
2,125	0,188	0,218	92 AU 9250	SYM	560005212C00A	-	●		
2,125	0,25	0,275	93 AU 2093 /N3101	LSU	18702125250-2093	-	○		
2,125	0,25	0,275	93 AU 2093 /N3101	LSU	18702125250B-2093	-	○		
2,125	0,25	0,281	92 AU 9250	PI	560002140E00A	-	○		
2,125	0,25	0,281	92 AU 9250	SYM	560005212E00A	-	●		
2,125	0,313	0,343	92 AU 9250	PI	560002141000A	-	●		
2,125	0,313	0,343	92 AU 9250	SYM	560005213000A	-	●		
2,125	0,313	0,344	93 AU 2093 /N3101	LSU	18702125312B-2093	-	●		
2,125	0,375	0,406	92 AU 9250	PI	560002140000A	-	●		
2,125	0,375	0,406	92 AU 9250	SYM	560005212000A	-	●		
2,125	0,375	0,413	93 AU 2093 /N3101	LSU	18702125375-2093	-	○		
2,125	0,375	0,413	93 AU 2093 /N3101	LSU	18702125375B-2093	-	○		
2,127	0,378	0,424	80L-155-94	VCT	56VCT-2500-814	-	○		
2,127	0,378	0,424	80L-155-95	VCT	56VCT-2500-815	-	●		
2,127	0,378	0,424	80L-405-94	VCT	56VCT-2500-844	-	○		

D [inch]	d [inch]	H [inch]	L [inch]	Material	Design	Part No.	PU ¹⁾	US	EU
2,5	2,13	0,25	0,281	98 AU 928 /NBR	DISO-PAC	302-330-0001	-	●	
	2,25	0,125	0,138	93 AU 2093 /N3101	LSU	12502250-2093	-	○	
	2,25	0,25	0,275	93 AU 2093 /N3101	LSU	12502250250B-2093	-	○	
2,563	1,938	0,313	0,344	93 AU 2093 /N3101	LSU	31201937-2093	-	○	
	1,875	0,375	0,413	93 AU 2093 /N3101	LSU	37501875-2093	-	○	
	1,875	0,625	0,688	93 AU 2093 /N3101	LSU	37501875625-2093	-	●	
	2	0,25	0,281	92 AU 9250	SYM	005206E00A	-	○	
	2	0,312	0,343	92 AU 9250	SYM	005206G00A	-	●	
	2	0,313	0,344	93 AU 2093 /N3101	LSU	31202000-2093	-	●	
	2	0,375	0,406	92 AU 9250	SYM	005208000A	-	●	
	2	0,375	0,413	93 AU 2093 /N3101	LSU	31202000375B-2093	-	○	
	2	0,437	0,481	93 AU 2093 /N3101	LSU	31202000437B-2093	-	○	
	2	0,5	0,531	92 AU 9250	SYM	005206000A	-	○	
2,625	2	0,5	0,55	93 AU 2093 /N3101	LSU	31202000500-2093	-	○	
	2	0,5	0,55	93 AU 2093 /N3101	LSU	31202000500B-2093	-	○	
	2,125	0,188	0,218	92 AU 9250	SYM	560005219C00A	-	○	
	2,125	0,25	0,275	93 AU 2093 /N3101	LSU	25002125-2093	-	○	
	2,125	0,25	0,281	92 AU 9250	SYM	560005214E00A	-	○	
	2,125	0,375	0,406	92 AU 9250	PI	560002145000A	-	●	
	2,125	0,375	0,406	92 AU 9250	SYM	560005214000A	-	●	
	2,125	0,375	0,413	93 AU 2093 /N3101	LSU	25002125375B-2093	-	○	
	2,25	0,188	0,207	93 AU 2093 /N3101	LSU	18702250-2093	-	○	
	2,25	0,188	0,207	93 AU 2093 /N3101	LSU	18702250SQB-2093	-	○	
2,75	2,25	0,313	0,343	92 AU 9250	SYM	560005220000A	-	●	
	2,25	0,313	0,344	93 AU 2093 /N3101	LSU	18702250312B-2093	-	○	
	2,25	0,375	0,406	92 AU 9250	SYM	560005219000A	-	●	
	1,75	0,5	0,55	93 AU 2093 /N3101	LSU	50001750-2093	-	○	
	2	0,375	0,406	92 AU 9250	PI	560002151000A	-	○	
	2	0,375	0,406	92 AU 9250	SYM	560005211000A	-	●	
	2	0,375	0,413	93 AU 2093 /N3101	LSU	37502000-2093	-	○	
	2	0,375	0,413	93 AU 2093 /N3101	LSU	37502000SQB-2093	-	●	
	2	0,5	0,531	92 AU 9250	PI	560002150000A	-	●	
	2	0,5	0,531	92 AU 9250	SYM	560005210000A	-	●	
2,75	2	0,5	0,55	93 AU 2093 /N3101	LSU	37502000500-2093	-	○	
	2	0,5	0,55	93 AU 2093 /N3101	LSU	37502000500B-2093	-	○	
	2	0,563	0,618	93 AU 2093 /N3101	LSU	37502000562B-2093	-	○	
	2	0,625	0,656	92 AU 9250	SYM	560005209000A	-	○	
	2	0,625	0,688	93 AU 2093 /N3101	LSU	37502000625B-2093	-	○	
	2,125	0,312	0,343	92 AU 9250	SYM	560005216G00A	-	○	
	2,125	0,313	0,343	92 AU 9250	PI	560002325G00A	-	○	
	2,125	0,313	0,344	93 AU 2093 /N3101	LSU	31202125-2093	-	○	
	2,125	0,375	0,406	92 AU 9250	SYM	560005218000A	-	●	
	2,125	0,5	0,531	92 AU 9250	SYM	560005216000A	-	○	
2,75	2,192	0,275	0,295	80L-150-98	VCT	56VCT044-808	-	●	
	2,25	0,25	0,275	93 AU 2093 /N3101	LSU	25002250-2093	-	○	
	2,25	0,25	0,275	93 AU 2093 /N3101	LSU	25002250SQB-2093	-	○	
	2,25	0,313	0,343	92 AU 9250	PI	560002153000A	-	●	
	2,25	0,313	0,343	92 AU 9250	SYM	005222000A	-	●	
	2,25	0,375	0,406	92 AU 9250	PI	560002152000A	-	●	
	2,25	0,375	0,406	92 AU 9250	SYM	560005221000A	-	●	

D [inch]	d [inch]	H [inch]	L [inch]	Material	Design	Part No.	PU ¹⁾	US	EU
2,75	2,25	0,375	0,413	93 AU 2093 /N3101	LSU	25002250375-2093	-	○	
	2,356	0,115	0,13	HT 2022	PolyHone 1704	561704-044	-	○	
	2,356	0,115	0,13	HT 2055	PolyHone 1704	561704-044-2055	-	●	
	2,375	0,188	0,207	93 AU 2093 /N3101	LSU	18702375-2093	-	●	
	2,375	0,375	0,406	92 AU 9250	SYM	560005229000A	-	●	
	2,375	0,375	0,413	93 AU 2093 /N3101	LSU	18702375375-2093	-	○	
	2,375	0,375	0,413	93 AU 2093 /N3101	LSU	18702375375B-2093	-	●	
	2,38	0,25	0,281	98 AU 928 /NBR	DISO-PAC	302-332-0001	-	●	
	2,5	0,125	0,138	93 AU 2093 /N3101	LSU	12502500-2093	-	○	
2,875	1,875	0,625	0,656	92 AU 9250	SYM	5600055230B0A	-	●	
	2,125	0,375	0,413	93 AU 2093 /N3101	LSU	37502125-2093	-	○	
	2,125	0,625	0,688	93 AU 2093 /N3101	LSU	37502125625B-2093	-	○	
	2,25	0,25	0,281	92 AU 9250	SYM	560005223E00A	-	○	
	2,25	0,312	0,343	92 AU 9250	SYM	560005223G00A	-	○	
	2,25	0,375	0,406	92 AU 9250	SYM	560005225000A	-	●	
	2,25	0,5	0,531	92 AU 9250	SYM	560005223000A	-	●	
	2,25	0,5	0,55	93 AU 2093 /N3101	LSU	31202250500B-2093	-	○	
	2,375	0,375	0,406	92 AU 9250	PI	002157000A	-	○	
	2,375	0,375	0,406	92 AU 9250	SYM	005231000A	-	●	
	2,375	0,375	0,413	93 AU 2093 /N3101	LSU	25002375375B-2093	-	○	
	2,5	0,188	0,207	93 AU 2093 /N3101	LSU	18702500-2093	-	●	
	2,5	0,188	0,207	93 AU 2093 /N3101	LSU	18702500SQB-2093	-	○	
	2,5	0,25	0,275	93 AU 2093 /N3101	LSU	18702500250B-2093	-	○	
	2,5	0,25	0,281	92 AU 9250	SYM	560005239E00A	-	●	
	2,5	0,313	0,344	93 AU 2093 /N3101	LSU	18702500312B-2093	-	○	
	2,5	0,375	0,406	92 AU 9250	SYM	560005239000A	-	●	
	2,5	0,375	0,413	93 AU 2093 /N3101	LSU	18702500375-2093	-	○	
	2,5	0,375	0,413	93 AU 2093 /N3101	LSU	18702500375B-2093	-	○	
	2,625	0,125	0,138	93 AU 2093 /N3101	LSU	12502625-2093	-	○	
3	2	0,5	0,55	93 AU 2093 /N3101	LSU	50002000-2093	-	○	
	2,25	0,375	0,406	92 AU 9250	PI	560002161000A	-	○	
	2,25	0,375	0,406	92 AU 9250	SYM	005228000A	-	●	
	2,25	0,375	0,413	93 AU 2093 /N3101	LSU	37502250-2093	-	○	
	2,25	0,375	0,413	93 AU 2093 /N3101	LSU	37502250SQB-2093	-	○	
	2,25	0,5	0,531	92 AU 9250	PI	560002160000A	-	●	
	2,25	0,5	0,531	92 AU 9250	SYM	005227000A	-	●	
	2,25	0,5	0,55	93 AU 2093 /N3101	LSU	37502250500B-2093	-	●	
	2,25	0,625	0,656	92 AU 9250	PI	560002159000A	-	●	
	2,25	0,625	0,656	92 AU 9250	SYM	005226000A	-	●	
	2,25	0,625	0,688	93 AU 2093 /N3101	LSU	37502250625B-2093	-	○	
	2,375	0,313	0,343	92 AU 9250	SYM	560005233G00A	-	○	
	2,375	0,313	0,344	93 AU 2093 /N3101	LSU	31202375-2093	-	●	
	2,375	0,375	0,406	92 AU 9250	PI	560002164000A	-	●	
	2,375	0,375	0,406	92 AU 9250	SYM	560005235000A	-	●	
	2,375	0,5	0,531	92 AU 9250	PI	560002162000A	-	●	
	2,375	0,5	0,531	92 AU 9250	SYM	560005233000A	-	●	
	2,375	0,5	0,55	93 AU 2093 /N3101	LSU	31202375500B-2093	-	○	
	2,384	0,265	0,288	80L-150-98	VCT	56VCT048-808AX	-	●	
	2,442	0,395	0,42	80L-150-98	VCT	56VCT048-808	-	●	
2,5	0,25	0,275	93 AU 2093 /N3101	LSU	25002500-2093	-	●		

D [inch]	d [inch]	H [inch]	L [inch]	Material	Design	Part No.	PU ¹⁾	US	EU	
3	2,5	0,25	0,275	93 AU 2093 /N3101	LSU	25002500SQB-2093	-	○		
	2,5	0,25	0,281	92 AU 9250	PI	560002165E00A	-	○		
	2,5	0,25	0,281	92 AU 9250	SYM	560005240E00A	-	●		
	2,5	0,313	0,343	92 AU 9250	PI	560002166000A	-	●		
	2,5	0,313	0,343	92 AU 9250	SYM	560005241000A	-	●		
	2,5	0,375	0,406	92 AU 9250	PI	560002165000A	-	●		
	2,5	0,375	0,406	92 AU 9250	SYM	560005240000A	-	●		
	2,5	0,375	0,413	93 AU 2093 /N3101	LSU	25002500375-2093	-	○		
	2,5	0,375	0,413	93 AU 2093 /N3101	LSU	25002500375B-2093	-	○		
	2,5	0,5	0,55	93 AU 2093 /N3101	LSU	25002500500B-2093	-	○		
	2,522	0,56	0,579	80L-155-94	VCT	56VCT-3000-814	-	○		
	2,522	0,56	0,579	80L-155-95	VCT	56VCT-3000-815	-	●		
	2,606	0,115	0,13	HT 2022	PolyHone 1704	561704-048	-	●		
	2,606	0,115	0,13	HT 2055	PolyHone 1704	561704-048-2055	-	●		
	2,625	0,188	0,207	93 AU 2093 /N3101	LSU	18702625-2093	-	●		
	2,625	0,25	0,281	92 AU 9250	SYM	560005248E00A	-	●		
	2,625	0,281	0,312	92 AU 9250	SYM	560005248F00A	-	○		
	2,625	0,312	0,343	92 AU 9250	SYM	560005248G00A	-	○		
	2,625	0,375	0,406	92 AU 9250	SYM	560005248000A	-	●		
	2,625	0,375	0,413	93 AU 2093 /N3101	LSU	18702625375B-2093	-	○		
	2,63	0,25	0,281	98 AU 928 /NBR	DISO-PAC	302-334-0001	-	●		
	2,75	0,25	0,275	93 AU 2093 /N3101	LSU	12502750250B-2093	-	○		
	3,063	2,563	0,375	0,413	93 AU 2093 /N3101	LSU	25002562375B-2093	-	○	
	3,125	2,375	0,375	0,413	93 AU 2093 /N3101	LSU	37502375-2093	-	○	
		2,5	0,313	0,343	92 AU 9250	SYM	560005242G00A	-	○	
2,5		0,313	0,344	93 AU 2093 /N3101	LSU	31202500-2093	-	○		
2,5		0,313	0,344	93 AU 2093 /N3101	LSU	31202500SQB-2093	-	○		
2,5		0,375	0,406	92 AU 9250	SYM	560005244000A	-	○		
2,5		0,5	0,531	92 AU 9250	SYM	560005242000A	-	●		
2,5		0,5	0,55	93 AU 2093 /N3101	LSU	31202500500B-2093	-	○		
2,5		0,625	0,688	93 AU 2093 /N3101	LSU	31202500625B-2093	-	○		
2,625		0,25	0,281	92 AU 9250	SYM	560005249E00A	-	○		
2,625		0,375	0,406	92 AU 9250	SYM	560005249000A	-	●		
2,75		0,188	0,207	93 AU 2093 /N3101	LSU	18702750-2093	-	○		
2,75		0,375	0,413	93 AU 2093 /N3101	LSU	18702750375-2093	-	○		
2,75		0,375	0,413	93 AU 2093 /N3101	LSU	18702750375B-2093	-	○		
3,25		2,25	0,5	0,55	93 AU 2093 /N3101	LSU	50002250-2093	-	○	
		2,5	0,375	0,406	92 AU 9250	PI	560002173000A	-	●	
	2,5	0,375	0,406	92 AU 9250	SYM	560005247000A	-	●		
	2,5	0,375	0,413	93 AU 2093 /N3101	LSU	37502500-2093	-	●		
	2,5	0,375	0,413	93 AU 2093 /N3101	LSU	37502500SQB-2093	-	○		
	2,5	0,5	0,531	92 AU 9250	SYM	560005246000A	-	●		
	2,5	0,5	0,55	93 AU 2093 /N3101	LSU	37502500500B-2093	-	○		
	2,5	0,625	0,656	92 AU 9250	PI	002171000A	-	●		
	2,5	0,625	0,656	92 AU 9250	SYM	560005245000A	-	●		
	2,5	0,625	0,688	93 AU 2093 /N3101	LSU	37502500625-2093	-	○		
	2,5	0,625	0,688	93 AU 2093 /N3101	LSU	37502500625B-2093	-	○		
	2,625	0,375	0,406	92 AU 9250	SYM	560005251000A	-	●		
	2,625	0,5	0,531	92 AU 9250	SYM	560005250000A	-	○		
	2,625	0,5	0,55	93 AU 2093 /N3101	LSU	31202625500B-2093	-	○		

D [inch]	d [inch]	H [inch]	L [inch]	Material	Design	Part No.	PU ¹⁾	US	EU	
3,25	2,634	0,25	0,288	98 AU 928 /NBR	DISO-PAC	302-336-0011	-	○		
	2,692	0,395	0,42	80L-150-98	VCT	56VCT052-808	-	●		
	2,75	0,25	0,275	93 AU 2093 /N3101	LSU	25002750-2093	-	○		
	2,75	0,25	0,275	93 AU 2093 /N3101	LSU	25002750SQB-2093	-	●		
	2,75	0,25	0,281	92 AU 9250	SYM	560005255E00A	-	○		
	2,75	0,375	0,406	92 AU 9250	PI	560002176000A	-	●		
	2,75	0,375	0,406	92 AU 9250	SYM	560005255000A	-	●		
	2,75	0,375	0,413	93 AU 2093 /N3101	LSU	25002750375B-2093	-	●		
	2,772	0,56	0,579	80L-155-94	VCT	56VCT-3250-814	-	○		
	2,856	0,115	0,13	HT 2022	PolyHone 1704	561704-052	-	○		
	2,856	0,115	0,13	HT 2055	PolyHone 1704	561704-052-2055	-	○		
	2,875	0,188	0,207	93 AU 2093 /N3101	LSU	18702875-2093	-	○		
	2,875	0,188	0,218	92 AU 9250	SYM	560005260C00A	-	○		
	2,875	0,25	0,275	93 AU 2093 /N3101	LSU	18702875250B-2093	-	○		
	2,875	0,25	0,281	92 AU 9250	SYM	560005260E00A	-	●		
	2,875	0,375	0,406	92 AU 9250	SYM	005260000A	-	●		
	2,88	0,25	0,281	98 AU 928 /NBR	DISO-PAC	302-336-0001	-	●		
	3	0,125	0,138	93 AU 2093 /N3101	LSU	12503000-2093	-	○		
	3,375	2,625	0,375	0,406	92 AU 9250	SYM	560005254000A	-	○	
		2,625	0,5	0,531	92 AU 9250	SYM	560005253000A	-	○	
2,625		0,625	0,656	92 AU 9250	SYM	560005252000A	-	○		
2,75		0,313	0,344	93 AU 2093 /N3101	LSU	31202750-2093	-	○		
2,875		0,25	0,275	93 AU 2093 /N3101	LSU	25002875-2093	-	○		
2,875		0,375	0,406	92 AU 9250	SYM	005261000A	-	●		
2,981		0,115	0,13	HT 2022	PolyHone 1704	561704-054	-	○		
3		0,188	0,207	93 AU 2093 /N3101	LSU	18703000-2093	-	○		
3		0,25	0,275	93 AU 2093 /N3101	LSU	18703000250-2093	-	○		
3		0,25	0,275	93 AU 2093 /N3101	LSU	18703000250B-2093	-	○		
3		0,375	0,406	92 AU 9250	SYM	560005267000A	-	●		
3		0,375	0,413	93 AU 2093 /N3101	LSU	18703000375-2093	-	○		
3	0,375	0,413	93 AU 2093 /N3101	LSU	18703000375B-2093	-	○			
3,5	2,5	0,5	0,55	93 AU 2093 /N3101	LSU	50002500-2093	-	○		
	2,5	0,75	0,825	93 AU 2093 /N3101	LSU	50002500750-2093	-	○		
	2,75	0,375	0,406	92 AU 9250	PI	560002185000A	-	●		
	2,75	0,375	0,406	92 AU 9250	SYM	560005259000A	-	●		
	2,75	0,375	0,413	93 AU 2093 /N3101	LSU	37502750-2093	-	●		
	2,75	0,375	0,413	93 AU 2093 /N3101	LSU	37502750SQB-2093	-	○		
	2,75	0,44	0,469	92 AU 9250	SYM	560005258Z00A	-	○		
	2,75	0,5	0,531	92 AU 9250	PI	560002184000A	-	○		
	2,75	0,5	0,531	92 AU 9250	SYM	005258000A	-	●		
	2,75	0,5	0,55	93 AU 2093 /N3101	LSU	37502750500B-2093	-	○		
	2,75	0,625	0,656	92 AU 9250	PI	560002183000A	-	●		
	2,75	0,625	0,656	92 AU 9250	SYM	005257000A	-	●		
	2,75	0,625	0,688	93 AU 2093 /N3101	LSU	37502750625B-2093	-	●		
	2,875	0,375	0,406	92 AU 9250	PI	560002187000A	-	●		
	2,875	0,375	0,406	92 AU 9250	SYM	005263000A	-	●		
	2,875	0,5	0,531	92 AU 9250	PI	560002186000A	-	●		
	2,875	0,5	0,531	92 AU 9250	SYM	005262000A	-	○		
	2,875	0,5	0,55	93 AU 2093 /N3101	LSU	31202875500B-2093	-	○		
	2,884	0,25	0,288	98 AU 928 /NBR	DISO-PAC	302-338-0011X	-	○		

D [inch]	d [inch]	H [inch]	L [inch]	Material	Design	Part No.	PU ¹⁾	US	EU
3,5	2,884	0,265	0,288	80L-155-98	VCT	56VCT056-818AX	-	●	
	3	0,25	0,275	93 AU 2093 /N3101	LSU	25003000-2093	-	●	
	3	0,25	0,275	93 AU 2093 /N3101	LSU	25003000SQB-2093	-	○	
	3	0,25	0,281	92 AU 9250	SYM	560005268E00A	-	●	
	3	0,375	0,406	92 AU 9250	PI	560002188000A	-	●	
	3	0,375	0,406	92 AU 9250	SYM	560005268000A	-	●	
	3	0,375	0,413	93 AU 2093 /N3101	LSU	25003000375-2093	-	●	
	3	0,375	0,413	93 AU 2093 /N3101	LSU	25003000375B-2093	-	○	
	3,022	0,56	0,579	80L-155-94	VCT	56VCT-3500-814	-	●	
	3,022	0,56	0,579	80L-155-95	VCT	56VCT-3500-815	-	●	
	3,106	0,115	0,13	HT 2022	PolyHone 1704	561704-056	-	○	
	3,106	0,115	0,13	HT 2055	PolyHone 1704	561704-056-2055	-	●	
	3,125	0,188	0,207	93 AU 2093 /N3101	LSU	18703125-2093	-	○	
	3,125	0,188	0,207	93 AU 2093 /N3101	LSU	18703125SQB-2093	-	○	
	3,125	0,375	0,406	92 AU 9250	PI	560002189000A	-	●	
	3,125	0,375	0,406	92 AU 9250	SYM	560005274000A	-	●	
	3,125	0,375	0,413	93 AU 2093 /N3101	LSU	18703125375B-2093	-	○	
	3,13	0,25	0,281	98 AU 928 /NBR	DISO-PAC	302-338-0001	-	●	
3,625	3	0,313	0,344	93 AU 2093 /N3101	LSU	31203000-2093	-	●	
	3	0,375	0,406	92 AU 9250	SYM	005270000A	-	●	
	3	0,375	0,413	93 AU 2093 /N3101	LSU	31203000375B-2093	-	○	
	3	0,5	0,531	92 AU 9250	PI	560002190000A	-	○	
	3	0,5	0,531	92 AU 9250	SYM	005269000A	-	●	
	3	0,5	0,55	93 AU 2093 /N3101	LSU	31203000500-2093	-	○	
	3,25	0,375	0,406	92 AU 9250	SYM	005278000A	-	○	
	3,25	0,375	0,413	93 AU 2093 /N3101	LSU	18703250375B-2093	-	○	
3,75	3	0,375	0,406	92 AU 9250	PI	002195000A	-	●	
	3	0,375	0,406	92 AU 9250	SYM	005273000A	-	●	
	3	0,375	0,413	93 AU 2093 /N3101	LSU	37503000-2093	-	●	
	3	0,375	0,413	93 AU 2093 /N3101	LSU	37503000SQB-2093	-	○	
	3	0,5	0,531	92 AU 9250	PI	002194000A	-	●	
	3	0,5	0,531	92 AU 9250	SYM	560005272000A	-	●	
	3	0,5	0,55	93 AU 2093 /N3101	LSU	37503000500B-2093	-	●	
	3	0,625	0,656	92 AU 9250	PI	002193000A	-	●	
	3	0,625	0,656	92 AU 9250	SYM	005271000A	-	○	
	3	0,625	0,688	93 AU 2093 /N3101	LSU	37503000625-2093	-	○	
	3	0,625	0,688	93 AU 2093 /N3101	LSU	37503000625B-2093	-	○	
	3,125	0,375	0,406	92 AU 9250	PI	560002197000A	-	●	
	3,125	0,375	0,406	92 AU 9250	SYM	005277000A	-	●	
	3,125	0,5	0,531	92 AU 9250	PI	560002196000A	-	●	
	3,125	0,5	0,531	92 AU 9250	SYM	005276000A	-	●	
	3,134	0,265	0,288	80L-155-98	VCT	56VCT060-818AX	-	○	
	3,25	0,25	0,275	93 AU 2093 /N3101	LSU	25003250-2093	-	○	
	3,25	0,375	0,406	92 AU 9250	PI	560002198000A	-	●	
	3,25	0,375	0,406	92 AU 9250	SYM	560005279000A	-	●	
	3,25	0,375	0,413	93 AU 2093 /N3101	LSU	25003250375B-2093	-	●	
	3,272	0,56	0,579	80L-155-95	VCT	56VCT-3750-815	-	○	
	3,356	0,115	0,13	HT 2022	PolyHone 1704	561704-060	-	○	
	3,356	0,115	0,13	HT 2055	PolyHone 1704	561704-060-2055	-	○	
	3,375	0,188	0,207	93 AU 2093 /N3101	LSU	18703375-2093	-	○	

D [inch]	d [inch]	H [inch]	L [inch]	Material	Design	Part No.	PU ¹⁾	US	EU
3,75	3,375	0,375	0,406	92 AU 9250	SYM	005285000A	-	●	
	3,375	0,375	0,413	93 AU 2093 /N3101	LSU	18703375375B-2093	-	○	
	3,38	0,25	0,281	98 AU 928 /NBR	DISO-PAC	302-340-0001	-	●	
3,875	3,125	0,625	0,688	93 AU 2093 /N3101	LSU	37503125625B-2093	-	○	
	3,25	0,313	0,344	93 AU 2093 /N3101	LSU	31203250-2093	-	○	
	3,25	0,5	0,55	93 AU 2093 /N3101	LSU	31203250500B-2093	-	○	
	3,375	0,25	0,275	93 AU 2093 /N3101	LSU	25003375SQB-2093	-	●	
	3,375	0,375	0,406	92 AU 9250	SYM	005286000A	-	●	
	3,5	0,188	0,207	93 AU 2093 /N3101	LSU	18703500-2093	-	○	
	3,5	0,25	0,275	93 AU 2093 /N3101	LSU	18703500250B-2093	-	○	
	3,5	0,375	0,406	92 AU 9250	SYM	560005292000A	-	●	
	3,5	0,375	0,413	93 AU 2093 /N3101	LSU	18703500375-2093	-	○	
	3,5	0,375	0,413	93 AU 2093 /N3101	LSU	18703500375B-2093	-	●	
4	3	0,5	0,531	92 AU 9250	SYM	560005524000A	-	●	
	3	0,5	0,55	93 AU 2093 /N3101	LSU	50003000-2093	-	○	
	3	0,5	0,55	93 AU 2093 /N3101	LSU	50003000SQB-2093	-	○	
	3	0,625	0,688	93 AU 2093 /N3101	LSU	50003000625B-2093	-	○	
	3	0,75	0,825	93 AU 2093 /N3101	LSU	50003000750B-2093	-	○	
	3,25	0,375	0,406	92 AU 9250	PI	560002207000A	-	●	
	3,25	0,375	0,406	92 AU 9250	SYM	005284000A	-	●	
	3,25	0,375	0,413	93 AU 2093 /N3101	LSU	37503250-2093	-	●	
	3,25	0,375	0,413	93 AU 2093 /N3101	LSU	37503250SQB-2093	-	●	
	3,25	0,5	0,531	92 AU 9250	PI	560002206000A	-	●	
	3,25	0,5	0,531	92 AU 9250	SYM	005283000A	-	●	
	3,25	0,5	0,55	93 AU 2093 /N3101	LSU	37503250500B-2093	-	○	
	3,25	0,625	0,656	92 AU 9250	PI	560002205000A	-	●	
	3,25	0,625	0,656	92 AU 9250	SYM	005282000A	-	●	
	3,25	0,625	0,688	93 AU 2093 /N3101	LSU	37503250625B-2093	-	○	
	3,375	0,313	0,344	93 AU 2093 /N3101	LSU	31203375-2093	-	○	
	3,375	0,375	0,406	92 AU 9250	PI	560002209000A	-	●	
	3,375	0,5	0,531	92 AU 9250	PI	560002208000A	-	●	
	3,375	0,5	0,55	93 AU 2093 /N3101	LSU	31203375500-2093	-	○	
	3,375	0,5	0,55	93 AU 2093 /N3101	LSU	31203375500B-2093	-	○	
	3,384	0,25	0,288	98 AU 928 /NBR	DISO-PAC	302-342-0011	-	○	
	3,384	0,265	0,288	80L-150-98	VCT	VCT064-808AX	-	●	
	3,442	0,395	0,42	80L-150-98	VCT	56VCT064-808	-	●	
	3,5	0,188	0,207	93 AU 2093 /N3101	LSU	25003500187B-2093	-	○	
	3,5	0,25	0,275	93 AU 2093 /N3101	LSU	25003500-2093	-	●	
	3,5	0,25	0,275	93 AU 2093 /N3101	LSU	25003500SQB-2093	-	●	
	3,5	0,25	0,281	92 AU 9250	PI	560002210E00A	-	○	
	3,5	0,25	0,281	92 AU 9250	SYM	560005293E00A	-	●	
	3,5	0,312	0,343	92 AU 9250	SYM	560005293G00A	-	○	
	3,5	0,345	0,375	80L-155-95	VCT	VCT-4000-815SP	-	●	
	3,5	0,375	0,406	92 AU 9250	PI	560002210000A	-	●	
	3,5	0,375	0,406	92 AU 9250	SYM	560005293000A	-	●	
	3,5	0,375	0,413	93 AU 2093 /N3101	LSU	25003500375-2093	-	○	
3,5	0,375	0,413	93 AU 2093 /N3101	LSU	25003500375B-2093	-	●		
3,5	0,5	0,55	93 AU 2093 /N3101	LSU	25003500500-2093	-	○		
3,5	0,5	0,55	93 AU 2093 /N3101	LSU	25003500500B-2093	-	●		
3,522	0,56	0,579	80L-155-94	VCT	56VCT-4000-814	-	●		

D [inch]	d [inch]	H [inch]	L [inch]	Material	Design	Part No.	PU ¹⁾	US	EU
4	3,522	0,56	0,579	80L-155-95	VCT	56VCT4000-815	-	●	
	3,522	0,56	0,579	80L-405-94	VCT	56VCT4000-844	-	○	
	3,606	0,115	0,13	HT 2022	PolyHone 1704	561704-064	-	●	
	3,606	0,115	0,13	HT 2055	PolyHone 1704	561704-064-2055	-	●	
	3,625	0,188	0,207	93 AU 2093 /N3101	LSU	18703625-2093	-	●	
	3,625	0,188	0,207	93 AU 2093 /N3101	LSU	18703625SQB-2093	-	○	
	3,625	0,25	0,281	92 AU 9250	SYM	560005302E00A	-	○	
	3,625	0,375	0,406	92 AU 9250	PI	560002211000A	-	●	
	3,625	0,375	0,406	92 AU 9250	SYM	560005302000A	-	●	
	3,625	0,375	0,413	93 AU 2093 /N3101	LSU	18703625375-2093	-	○	
	3,625	0,375	0,413	93 AU 2093 /N3101	LSU	18703625375B-2093	-	○	
	3,63	0,25	0,281	98 AU 928 /NBR	DISO-PAC	302-342-0001	-	●	
	4,125	3,5	0,375	0,406	92 AU 9250	SYM	005295000A	-	●
3,5		0,5	0,531	92 AU 9250	SYM	005294000A	-	●	
3,5		0,5	0,55	93 AU 2093 /N3101	LSU	31203500500B-2093	-	○	
3,625		0,375	0,406	92 AU 9250	PI	560002214000A	-	○	
3,625		0,375	0,406	92 AU 9250	SYM	005303000A	-	○	
3,625		0,375	0,413	93 AU 2093 /N3101	LSU	25003625375B-2093	-	○	
3,75		0,188	0,207	93 AU 2093 /N3101	LSU	18703750-2093	-	○	
3,75		0,375	0,406	92 AU 9250	SYM	560005307000A	-	●	
3,75		0,375	0,413	93 AU 2093 /N3101	LSU	18703750375B-2093	-	○	
3,5		0,375	0,406	92 AU 9250	PI	560002217000A	-	●	
4,25	3,5	0,375	0,406	92 AU 9250	SYM	005298000A	-	●	
	3,5	0,375	0,413	93 AU 2093 /N3101	LSU	37503500-2093	-	○	
	3,5	0,375	0,413	93 AU 2093 /N3101	LSU	37503500SQB-2093	-	○	
	3,5	0,5	0,531	92 AU 9250	SYM	005297000A	-	●	
	3,5	0,5	0,55	93 AU 2093 /N3101	LSU	37503500500-2093	-	○	
	3,5	0,625	0,656	92 AU 9250	SYM	560005296000A	-	●	
	3,5	0,625	0,688	93 AU 2093 /N3101	LSU	37503500625B-2093	-	○	
	3,625	0,313	0,344	93 AU 2093 /N3101	LSU	31203625-2093	-	○	
	3,625	0,375	0,406	92 AU 9250	PI	560002219000A	-	○	
	3,625	0,375	0,406	92 AU 9250	SYM	005305000A	-	●	
	3,625	0,5	0,531	92 AU 9250	PI	560002218000A	-	●	
	3,625	0,5	0,55	93 AU 2093 /N3101	LSU	31203625500B-2093	-	○	
	3,692	0,395	0,42	80L-150-98	VCT	56VCT068-808	-	●	
	3,75	0,25	0,275	93 AU 2093 /N3101	LSU	25003750-2093	-	○	
	3,75	0,375	0,406	92 AU 9250	PI	002220000A	-	●	
	3,75	0,375	0,406	92 AU 9250	SYM	560005308000A	-	●	
	3,75	0,375	0,413	93 AU 2093 /N3101	LSU	25003750375-2093	-	○	
	3,75	0,375	0,413	93 AU 2093 /N3101	LSU	25003750375B-2093	-	●	
	3,75	0,5	0,55	93 AU 2093 /N3101	LSU	25003750500B-2093	-	○	
	3,772	0,56	0,579	80L-155-95	VCT	56VCT4250-815	-	●	
3,856	0,115	0,13	HT 2022	PolyHone 1704	561704-068	-	○		
3,856	0,115	0,13	HT 2055	PolyHone 1704	561704-068-2055	-	○		
3,875	0,375	0,406	92 AU 9250	SYM	005516000A	-	○		
3,875	0,375	0,413	93 AU 2093 /N3101	LSU	18703875375B-2093	-	○		
3,88	0,25	0,281	98 AU 928 /NBR	DISO-PAC	302-344-0001	-	●		
4	0,125	0,138	93 AU 2093 /N3101	LSU	12504000-2093	-	○		
4,375	3,625	0,5	0,55	93 AU 2093 /N3101	LSU	37503625500B-2093	-	○	
	3,625	0,625	0,688	93 AU 2093 /N3101	LSU	37503625625B-2093	-	○	

D [inch]	d [inch]	H [inch]	L [inch]	Material	Design	Part No.	PU ¹⁾	US	EU
4,375	3,75	0,313	0,344	93 AU 2093 /N3101	LSU	31203750-2093	-	○	
	3,75	0,375	0,413	93 AU 2093 /N3101	LSU	31203750375B-2093	-	○	
	3,75	0,5	0,55	93 AU 2093 /N3101	LSU	31203750500B-2093	-	○	
	3,75	0,625	0,688	93 AU 2093 /N3101	LSU	31203750625B-2093	-	○	
	4	0,188	0,207	93 AU 2093 /N3101	LSU	18704000-2093	-	○	
	4	0,25	0,275	93 AU 2093 /N3101	LSU	18704000250B-2093	-	○	
	4	0,375	0,406	92 AU 9250	SYM	560005322000A	-	●	
4,5	4	0,375	0,413	93 AU 2093 /N3101	LSU	18704000375B-2093	-	○	
	3,5	0,5	0,531	92 AU 9250	SYM	005301000A	-	●	
	3,5	0,5	0,55	93 AU 2093 /N3101	LSU	50003500-2093	-	●	
	3,5	0,625	0,656	92 AU 9250	SYM	005300000A	-	○	
	3,5	0,656	0,687	92 AU 9250	SYM	560005299S00A	-	○	
	3,5	0,75	0,825	93 AU 2093 /N3101	LSU	50003500750B-2093	-	●	
	3,75	0,375	0,406	92 AU 9250	PI	560002229000A	-	●	
	3,75	0,375	0,406	92 AU 9250	SYM	560005313000A	-	●	
	3,75	0,375	0,413	93 AU 2093 /N3101	LSU	37503750-2093	-	●	
	3,75	0,5	0,531	92 AU 9250	PI	560002228000A	-	●	
	3,75	0,5	0,531	92 AU 9250	SYM	560005312000A	-	●	
	3,75	0,5	0,55	93 AU 2093 /N3101	LSU	37503750500B-2093	-	○	
	3,75	0,625	0,656	92 AU 9250	PI	560002227000A	-	●	
	3,75	0,625	0,656	92 AU 9250	SYM	560005311000A	-	●	
	3,75	0,625	0,688	93 AU 2093 /N3101	LSU	37503750625-2093	-	○	
	3,75	0,625	0,688	93 AU 2093 /N3101	LSU	37503750625B-2093	-	○	
	3,875	0,375	0,406	92 AU 9250	PI	560002231000A	-	●	
	3,875	0,375	0,406	92 AU 9250	SYM	005316000A	-	●	
	3,875	0,5	0,531	92 AU 9250	PI	560002230000A	-	●	
	3,875	0,5	0,531	92 AU 9250	SYM	005315000A	-	●	
	3,875	0,5	0,55	93 AU 2093 /N3101	LSU	31203875500-2093	-	○	
	3,884	0,25	0,288	98 AU 928 /NBR	DISO-PAC	302-346-0011	-	●	
	3,884	0,265	0,288	80L-155-98	VCT	56VCT072-818AX	-	●	
	3,942	0,395	0,42	80L-150-98	VCT	56VCT072-808	-	●	
	4	0,25	0,275	93 AU 2093 /N3101	LSU	25004000-2093	-	●	
	4	0,25	0,275	93 AU 2093 /N3101	LSU	25004000SQB-2093	-	●	
	4	0,312	0,343	92 AU 9250	SYM	560005517G00A	-	○	
	4	0,375	0,406	92 AU 9250	PI	560002232I00A	-	●	
	4	0,375	0,406	92 AU 9250	SYM	560005517I00A	-	●	
	4	0,375	0,413	93 AU 2093 /N3101	LSU	25004000375-2093	-	●	
	4	0,375	0,413	93 AU 2093 /N3101	LSU	25004000375B-2093	-	●	
	4	0,5	0,55	93 AU 2093 /N3101	LSU	25004000500B-2093	-	○	
	4	0,563	0,593	92 AU 9250	PI	560002232000A	-	●	
4	0,563	0,593	92 AU 9250	SYM	560005517000A	-	●		
4	0,563	0,618	93 AU 2093 /N3101	LSU	25004000562-2093	-	○		
4	0,563	0,618	93 AU 2093 /N3101	LSU	25004000562B-2093	-	○		
4	0,625	0,688	93 AU 2093 /N3101	LSU	25004000625-2093	-	○		
4,022	0,56	0,579	80L-155-94	VCT	56VCT4500-814	-	○		
4,022	0,56	0,579	80L-155-95	VCT	56VCT4500-815	-	●		
4,022	0,56	0,579	80L-405-94	VCT	56VCT4500-844	-	○		
4,125	0,188	0,207	93 AU 2093 /N3101	LSU	18704125-2093	-	●		
4,125	0,375	0,413	93 AU 2093 /N3101	LSU	18704125375-2093	-	○		
4,125	0,375	0,413	93 AU 2093 /N3101	LSU	18704125375B-2093	-	○		

D [inch]	d [inch]	H [inch]	L [inch]	Material	Design	Part No.	PU ¹⁾	US	EU
4,5	4,13	0,25	0,281	98 AU 928 /NBR	DISO-PAC	302-346-0001	-	●	
4,625	3,875	0,375	0,413	93 AU 2093 /N3101	LSU	37503875-2093	-	○	
	4	0,313	0,344	93 AU 2093 /N3101	LSU	31204000-2093	-	●	
	4	0,375	0,406	92 AU 9250	SYM	005325000A	-	●	
	4	0,375	0,413	93 AU 2093 /N3101	LSU	31204000375-2093	-	○	
	4	0,5	0,531	92 AU 9250	PI	002236000A	-	○	
	4	0,5	0,55	93 AU 2093 /N3101	LSU	31204000500B-2093	-	○	
	4	0,563	0,618	93 AU 2093 /N3101	LSU	31204000562B-2093	-	○	
	4,125	0,25	0,275	93 AU 2093 /N3101	LSU	25004125-2093	-	○	
	4,125	0,563	0,593	92 AU 9250	SYM	005330000A	-	○	
	4,25	0,188	0,207	93 AU 2093 /N3101	LSU	18704250-2093	-	○	
4,75	3,875	0,75	0,825	93 AU 2093 /N3101	LSU	43703875750B-2093	-	○	
	4	0,375	0,406	92 AU 9250	SYM	560005328000A	-	●	
	4	0,375	0,413	93 AU 2093 /N3101	LSU	37504000SQB-2093	-	○	
	4	0,437	0,469	92 AU 9250	SYM	005326K00A	-	○	
	4	0,5	0,531	92 AU 9250	SYM	560005327000A	-	●	
	4	0,5	0,55	93 AU 2093 /N3101	LSU	37504000500B-2093	-	○	
	4	0,625	0,656	92 AU 9250	SYM	005326000A	-	●	
	4	0,625	0,688	93 AU 2093 /N3101	LSU	37504000625B-2093	-	●	
	4,125	0,5	0,531	92 AU 9250	SYM	005332000A	-	●	
	4,125	0,563	0,593	92 AU 9250	SYM	005331000A	-	○	
	4,125	0,563	0,618	93 AU 2093 /N3101	LSU	31204125562B-2093	-	●	
	4,192	0,395	0,42	80L-150-98	VCT	56VCT076-808	-	●	
	4,25	0,25	0,275	93 AU 2093 /N3101	LSU	25004250-2093	-	●	
	4,25	0,25	0,275	93 AU 2093 /N3101	LSU	25004250SQB-2093	-	○	
	4,25	0,375	0,406	92 AU 9250	SYM	560005337100A	-	●	
	4,25	0,563	0,593	92 AU 9250	PI	002244000A	-	●	
	4,25	0,563	0,593	92 AU 9250	SYM	005337000A	-	●	
	4,25	0,563	0,618	93 AU 2093 /N3101	LSU	25004250562B-2093	-	●	
	4,272	0,56	0,579	80L-155-95	VCT	56VCT4750-815	-	○	
	4,356	0,115	0,13	HT 2022	PolyHone 1704	561704-076	-	○	
4,356	0,115	0,13	HT 2055	PolyHone 1704	561704-076-2055	-	○		
4,375	0,188	0,207	93 AU 2093 /N3101	LSU	18704375-2093	-	○		
4,375	0,375	0,406	92 AU 9250	SYM	005343000A	-	○		
4,375	0,375	0,413	93 AU 2093 /N3101	LSU	18704375375-2093	-	○		
4,375	0,375	0,413	93 AU 2093 /N3101	LSU	18704375375B-2093	-	○		
4,38	0,25	0,281	98 AU 928 /NBR	DISO-PAC	302-348-0001	-	●		
4,875	4,125	0,375	0,413	93 AU 2093 /N3101	LSU	37504125-2093	-	○	
	4,125	0,625	0,656	92 AU 9250	SYM	005334000A	-	○	
	4,25	0,313	0,344	93 AU 2093 /N3101	LSU	31204250-2093	-	○	
	4,25	0,563	0,618	93 AU 2093 /N3101	LSU	31204250562B-2093	-	○	
	4,375	0,25	0,275	93 AU 2093 /N3101	LSU	25004375-2093	-	○	
	4,5	0,188	0,207	93 AU 2093 /N3101	LSU	18704500-2093	-	○	
	4,5	0,375	0,406	92 AU 9250	SYM	005349000A	-	○	
	4,5	0,375	0,413	93 AU 2093 /N3101	LSU	18704500375-2093	-	○	
5	3,75	0,625	0,688	93 AU 2093 /N3101	LSU	62503750-2093	-	○	
	4	0,5	0,55	93 AU 2093 /N3101	LSU	50004000-2093	-	●	
	4	0,75	0,825	93 AU 2093 /N3101	LSU	50004000750-2093	-	○	
	4	0,75	0,825	93 AU 2093 /N3101	LSU	50004000750B-2093	-	○	
	4,25	0,375	0,406	92 AU 9250	PI	560002247100A	-	●	

D [inch]	d [inch]	H [inch]	L [inch]	Material	Design	Part No.	PU ¹⁾	US	EU
	4,25	0,375	0,406	92 AU 9250	SYM	560005341100A	-	●	
	4,25	0,375	0,413	HT 2053 /N3101	LSU	37504250-2053	-	○	
	4,25	0,375	0,413	93 AU 2093 /N3101	LSU	37504250-2093	-	●	
	4,25	0,375	0,413	93 AU 2093 /N3101	LSU	37504250SQB-2093	-	○	
	4,25	0,5	0,531	92 AU 9250	PI	560002248000A	-	●	
	4,25	0,5	0,531	92 AU 9250	SYM	560005342000A	-	●	
	4,25	0,5	0,55	93 AU 2093 /N3101	LSU	37504250500-2093	-	○	
	4,25	0,5	0,55	93 AU 2093 /N3101	LSU	37504250500B-2093	-	●	
	4,25	0,625	0,656	92 AU 9250	PI	560002247Y00A	-	●	
	4,25	0,625	0,656	92 AU 9250	PI	560002247000A	-	●	
	4,25	0,625	0,656	92 AU 9250	SYM	560005341000A	-	●	
	4,25	0,625	0,688	93 AU 2093 /N3101	LSU	37504250625-2093	-	●	
	4,25	0,625	0,688	93 AU 2093 /N3101	LSU	37504250625B-2093	-	●	
	4,274	0,705	0,75	80L-155-94	VCT	56VCT-5000-814	-	●	
	4,274	0,705	0,75	80L-555-94	VCT	56VCT-5000-815	-	●	
	4,274	0,705	0,75	80L-405-94	VCT	56VCT-5000-844	-	●	
	4,274	0,705	0,75	80L-555-94	VCT	56VCT-5000-854	-	●	
	4,375	0,313	0,344	93 AU 2093 /N3101	LSU	31204375-2093	-	●	
	4,375	0,375	0,406	92 AU 9250	SYM	560005346000A	-	●	
	4,375	0,5	0,531	92 AU 9250	SYM	560005345000A	-	●	
	4,375	0,5	0,55	93 AU 2093 /N3101	LSU	31204375500-2093	-	○	
	4,375	0,563	0,593	92 AU 9250	SYM	560005344000A	-	●	
5	4,375	0,563	0,618	93 AU 2093 /N3101	LSU	31204375562B-2093	-	●	
	4,375	0,625	0,688	93 AU 2093 /N3101	LSU	31204375625B-2093	-	○	
	4,384	0,25	0,288	98 AU 928 /NBR	DISO-PAC	302-350-0011	-	●	
	4,384	0,265	0,288	80L-155-98	VCT	VCT080-818AX	-	●	
	4,442	0,395	0,42	80L-150-98	VCT	56VCT080-808	-	●	
	4,5	0,25	0,275	93 AU 2093 /N3101	LSU	25004500-2093	-	●	
	4,5	0,25	0,281	92 AU 9250	PI	560002249E00A	-	○	
	4,5	0,313	0,344	93 AU 2093 /N3101	LSU	25004500312B-2093	-	○	
	4,5	0,375	0,406	92 AU 9250	PI	560002249I00A	-	●	
	4,5	0,375	0,406	92 AU 9250	SYM	005350I00A	-	●	
	4,5	0,375	0,413	93 AU 2093 /N3101	LSU	25004500375-2093	-	●	
	4,5	0,375	0,413	93 AU 2093 /N3101	LSU	25004500375B-2093	-	●	
	4,5	0,437	0,468	92 AU 9250	PI	560002249K00A	-	●	
	4,5	0,5	0,531	92 AU 9250	SYM	560005350M00A	-	●	
	4,5	0,5	0,55	93 AU 2093 /N3101	LSU	25004500500-2093	-	○	
	4,5	0,5	0,55	93 AU 2093 /N3101	LSU	25004500500B-2093	-	●	
	4,5	0,563	0,593	92 AU 9250	PI	560002249000A	-	●	
	4,5	0,563	0,593	92 AU 9250	SYM	560005350000A	-	●	
	4,5	0,563	0,618	93 AU 2093 /N3101	LSU	25004500562B-2093	-	○	
	4,5	0,625	0,688	93 AU 2093 /N3101	LSU	25004500625B-2093	-	○	
	4,606	0,115	0,13	HT 2022	PolyHone 1704	561704-080	-	○	
	4,606	0,115	0,13	HT 2055	PolyHone 1704	561704-080-2055	-	○	
	4,625	0,375	0,413	93 AU 2093 /N3101	LSU	18704625375B-2093	-	○	
5,002	4,63	0,25	0,281	98 AU 928 /NBR	DISO-PAC	302-350-0001	-	●	
	4,125	0,5	0,55	93 AU 2093 /N3101	LSU	50004125-2093	-	○	
5,125	4,125	0,75	0,825	93 AU 2093 /N3101	LSU	50004125750B-2093	-	○	
	4,375	0,375	0,413	93 AU 2093 /N3101	LSU	37504375-2093	-	○	
	4,375	0,5	0,531	92 AU 9250	PI	002251000A	-	●	

D [inch]	d [inch]	H [inch]	L [inch]	Material	Design	Part No.	PU ¹⁾	US	EU
5,125	4,375	0,625	0,688	93 AU 2093 /N3101	LSU	37504375625B-2093	-	○	
	4,5	0,313	0,344	93 AU 2093 /N3101	LSU	31204500-2093	-	○	
	4,5	0,375	0,406	92 AU 9250	SYM	005353000A	-	○	
	4,5	0,5	0,55	93 AU 2093 /N3101	LSU	31204500500B-2093	-	○	
	4,5	0,625	0,656	92 AU 9250	SYM	005351000A	-	○	
	4,5	0,625	0,688	93 AU 2093 /N3101	LSU	31204500625B-2093	-	○	
	4,625	0,563	0,618	93 AU 2093 /N3101	LSU	25004625562B-2093	-	○	
	4,75	0,188	0,207	93 AU 2093 /N3101	LSU	18704750-2093	-	○	
5,25	4,5	0,375	0,406	92 AU 9250	PI	560002254100A	-	●	
	4,5	0,375	0,413	93 AU 2093 /N3101	LSU	37504500-2093	-	○	
	4,5	0,375	0,413	93 AU 2093 /N3101	LSU	37504500SQB-2093	-	○	
	4,5	0,5	0,531	92 AU 9250	PI	560002255000A	-	●	
	4,5	0,5	0,531	92 AU 9250	SYM	560005355000A	-	●	
	4,5	0,625	0,656	92 AU 9250	PI	560002254000A	-	●	
	4,5	0,625	0,656	92 AU 9250	SYM	005354000A	-	●	
	4,5	0,625	0,688	93 AU 2093 /N3101	LSU	37504500625B-2093	-	○	
	4,524	0,705	0,75	80L-155-95	VCT	56VCT-5250-815	-	○	
	4,625	0,625	0,688	93 AU 2093 /N3101	LSU	31204625625B-2093	-	○	
	4,75	0,25	0,275	93 AU 2093 /N3101	LSU	25004750-2093	-	○	
	4,75	0,375	0,406	92 AU 9250	SYM	560005362100A	-	●	
	4,75	0,375	0,413	93 AU 2093 /N3101	LSU	25004750375B-2093	-	○	
	4,75	0,563	0,593	92 AU 9250	PI	002256000A	-	○	
	4,75	0,563	0,593	92 AU 9250	SYM	560005362000A	-	●	
	4,75	0,563	0,618	93 AU 2093 /N3101	LSU	25004750562-2093	-	○	
	4,75	0,625	0,688	93 AU 2093 /N3101	LSU	25004750625B-2093	-	○	
	4,856	0,115	0,13	HT 2022	PolyHone 1704	561704-084	-	○	
4,856	0,115	0,13	HT 2055	PolyHone 1704	561704-084-2055	-	○		
5,252	4,778	0,345	0,375	98 AU 928 /NBR	DISO-PAC	302-427-0001	-	○	
5,375	4,375	0,5	0,55	93 AU 2093 /N3101	LSU	50004375-2093	-	○	
	4,625	0,5	0,531	92 AU 9250	PI	560002258000A	-	●	
	4,625	0,5	0,531	92 AU 9250	SYM	005361000A	-	●	
	4,625	0,625	0,688	93 AU 2093 /N3101	LSU	37504625625B-2093	-	○	
	4,75	0,375	0,406	92 AU 9250	SYM	005365000A	-	○	
	4,75	0,5	0,531	92 AU 9250	SYM	005364000A	-	○	
	4,75	0,625	0,656	92 AU 9250	SYM	005363000A	-	○	
	4,875	0,25	0,275	93 AU 2093 /N3101	LSU	25004875-2093	-	○	
	4,875	0,563	0,618	93 AU 2093 /N3101	LSU	25004875562B-2093	-	○	
	5	0,188	0,207	93 AU 2093 /N3101	LSU	18705000-2093	-	○	
	5	0,375	0,413	93 AU 2093 /N3101	LSU	18705000375B-2093	-	○	
5,5	4,25	0,625	0,688	93 AU 2093 /N3101	LSU	62504250-2093	-	○	
	4,5	0,5	0,55	93 AU 2093 /N3101	LSU	50004500-2093	-	○	
	4,5	0,75	0,825	93 AU 2093 /N3101	LSU	50004500750B-2093	-	○	
	4,66	0,345	0,375	98 AU 928 /NBR	DISO-PAC	302-429-0011	-	○	
	4,75	0,375	0,413	93 AU 2093 /N3101	LSU	37504750-2093	-	○	
	4,75	0,375	0,413	93 AU 2093 /N3101	LSU	37504750SQB-2093	-	○	
	4,75	0,5	0,531	92 AU 9250	PI	560002260000A	-	●	
	4,75	0,5	0,531	92 AU 9250	SYM	005367000A	-	●	
	4,75	0,5	0,55	93 AU 2093 /N3101	LSU	37504750500-2093	-	○	
	4,75	0,5	0,55	93 AU 2093 /N3101	LSU	37504750500B-2093	-	○	
	4,75	0,625	0,656	92 AU 9250	PI	560002259000A	-	●	

D [inch]	d [inch]	H [inch]	L [inch]	Material	Design	Part No.	PU ¹⁾	US	EU
5,5	4,75	0,625	0,656	92 AU 9250	SYM	005366000A	-	●	
	4,75	0,625	0,688	93 AU 2093 /N3101	LSU	37504750625-2093	-	○	
	4,75	0,625	0,688	93 AU 2093 /N3101	LSU	37504750625B-2093	-	●	
	4,774	0,705	0,75	80L-155-94	VCT	56VCT-5500-814	-	●	
	4,774	0,705	0,75	80L-405-94	VCT	56VCT-5500-844	-	○	
	4,774	0,705	0,75	80L-155-95	VCT	VCT-5500-815	-	○	
	4,875	0,313	0,344	93 AU 2093 /N3101	LSU	31204875-2093	-	○	
	4,875	0,375	0,406	92 AU 9250	SYM	005371000A	-	●	
	4,875	0,5	0,531	92 AU 9250	SYM	005370000A	-	○	
	4,942	0,395	0,42	80L-150-98	VCT	56VCT088-808	-	●	
	5	0,25	0,275	93 AU 2093 /N3101	LSU	25005000-2093	-	●	
	5	0,25	0,275	93 AU 2093 /N3101	LSU	25005000SQB-2093	-	●	
	5	0,375	0,406	92 AU 9250	PI	560002261000A	-	●	
	5	0,375	0,413	93 AU 2093 /N3101	LSU	25005000375-2093	-	●	
	5	0,375	0,413	93 AU 2093 /N3101	LSU	25005000375B-2093	-	●	
	5	0,5	0,55	93 AU 2093 /N3101	LSU	25005000500B-2093	-	○	
	5	0,563	0,593	92 AU 9250	PI	560002261000A	-	●	
	5	0,563	0,618	93 AU 2093 /N3101	LSU	25005000562B-2093	-	○	
	5,106	0,115	0,13	HT 2022	PolyHone 1704	561704-088	-	○	
	5,106	0,115	0,13	HT 2055	PolyHone 1704	561704-088-2055	-	○	
5,52	5,028	0,345	0,375	98 AU 928 /NBR	DISCO-PAC	302-429-0001	-	●	
5,625	4,875	0,5	0,531	92 AU 9250	SYM	005373000A	-	○	
	4,875	0,625	0,688	93 AU 2093 /N3101	LSU	37504875625B-2093	-	○	
	5	0,313	0,344	93 AU 2093 /N3101	LSU	31205000-2093	-	○	
5,75	4,75	0,5	0,55	93 AU 2093 /N3101	LSU	50004750-2093	-	●	
	5	0,375	0,413	93 AU 2093 /N3101	LSU	37505000-2093	-	○	
	5	0,375	0,413	93 AU 2093 /N3101	LSU	37505000SQB-2093	-	○	
	5	0,5	0,531	92 AU 9250	PI	002265000A	-	●	
	5	0,5	0,55	93 AU 2093 /N3101	LSU	37505000500B-2093	-	○	
	5	0,625	0,688	93 AU 2093 /N3101	LSU	37505000625-2093	-	○	
	5	0,625	0,688	93 AU 2093 /N3101	LSU	37505000625B-2093	-	○	
	5,125	0,313	0,344	93 AU 2093 /N3101	LSU	31205125-2093	-	○	
	5,125	0,375	0,406	92 AU 9250	SYM	005383000A	-	○	
	5,125	0,5	0,531	92 AU 9250	SYM	005382000A	-	○	
	5,232	0,143	0,159	HT 2022	PolyHone 1704	561704-092	-	○	
	5,232	0,143	0,159	HT 2055	PolyHone 1704	561704-092-2055	-	○	
	5,25	0,25	0,275	93 AU 2093 /N3101	LSU	25005250-2093	-	○	
	5,25	0,375	0,413	93 AU 2093 /N3101	LSU	25005250375B-2093	-	●	
	5,25	0,563	0,593	92 AU 9250	SYM	005386000A	-	●	
	5,25	0,563	0,618	93 AU 2093 /N3101	LSU	25005250562-2093	-	○	
	5,25	0,563	0,618	93 AU 2093 /N3101	LSU	25005250562B-2093	-	○	
	5,875	5,125	0,375	0,413	93 AU 2093 /N3101	LSU	37505125-2093	-	○
5,25		0,375	0,406	92 AU 9250	SYM	005389000A	-	○	
5,25		0,5	0,531	92 AU 9250	SYM	005388000A	-	○	
5,375		0,25	0,275	93 AU 2093 /N3101	LSU	25005375-2093	-	○	
5,375		0,375	0,406	92 AU 9250	SYM	005392000A	-	○	
5,5		0,375	0,413	93 AU 2093 /N3101	LSU	18705500375B-2093	-	●	
6	4,75	0,625	0,688	93 AU 2093 /N3101	LSU	625047501000-2093	-	○	
	5	0,5	0,55	93 AU 2093 /N3101	LSU	50005000-2093	-	●	
	5	0,5	0,55	93 AU 2093 /N3101	LSU	50005000SQB-2093	-	○	

D [inch]	d [inch]	H [inch]	L [inch]	Material	Design	Part No.	PU ¹⁾	US	EU
6	5	0,75	0,825	93 AU 2093 /N3101	LSU	50005000750B-2093	-	●	
	5,16	0,345	0,375	98 AU 928 /NBR	DISO-PAC	302-433-0011	-	○	
	5,25	0,375	0,406	92 AU 9250	PI	560002269I00A	-	●	
	5,25	0,375	0,406	92 AU 9250	PI	560002270I00A	-	○	
	5,25	0,375	0,406	92 AU 9250	SYM	005390I00A	-	●	
	5,25	0,375	0,406	92 AU 9250	SYM	005391I00A	-	○	
	5,25	0,375	0,413	93 AU 2093 /N3101	LSU	37505250-2093	-	○	
	5,25	0,375	0,413	93 AU 2093 /N3101	LSU	37505250SQB-2093	-	●	
	5,25	0,5	0,531	92 AU 9250	PI	560002270000A	-	●	
	5,25	0,5	0,531	92 AU 9250	SYM	005391000A	-	●	
	5,25	0,5	0,55	93 AU 2093 /N3101	LSU	37505250500-2093	-	●	
	5,25	0,5	0,55	93 AU 2093 /N3101	LSU	37505250500B-2093	-	○	
	5,25	0,625	0,656	92 AU 9250	PI	560002269000A	-	●	
	5,25	0,625	0,656	92 AU 9250	SYM	005390000A	-	●	
	5,25	0,625	0,688	93 AU 2093 /N3101	LSU	37505250625-2093	-	●	
	5,25	0,625	0,688	93 AU 2093 /N3101	LSU	37505250625B-2093	-	●	
	5,375	0,313	0,344	93 AU 2093 /N3101	LSU	31205375-2093	-	●	
	5,375	0,313	0,344	93 AU 2093 /N3101	LSU	31205375SQB-2093	-	○	
	5,375	0,375	0,406	92 AU 9250	PI	002272000A	-	●	
	5,375	0,375	0,406	92 AU 9250	SYM	005395000A	-	●	
	5,375	0,5	0,531	92 AU 9250	PI	002271000A	-	●	
	5,375	0,5	0,531	92 AU 9250	SYM	005394000A	-	○	
	5,375	0,625	0,656	92 AU 9250	PI	560002323000A	-	○	
	5,375	0,625	0,656	92 AU 9250	SYM	005393000A	-	●	
	5,375	0,625	0,688	93 AU 2093 /N3101	LSU	31205375625-2093	-	○	
	5,482	0,143	0,159	HT 2022	PolyHone 1704	561704-096	-	○	
	5,482	0,143	0,159	HT 2055	PolyHone 1704	561704-096-2055	-	○	
	5,5	0,25	0,275	93 AU 2093 /N3101	LSU	25005500-2093	-	○	
	5,5	0,25	0,275	93 AU 2093 /N3101	LSU	25005500SQB-2093	-	○	
	5,5	0,25	0,281	92 AU 9250	PI	560002273E00A	-	●	
	5,5	0,375	0,406	92 AU 9250	PI	560002273I00A	-	●	
	5,5	0,375	0,413	93 AU 2093 /N3101	LSU	25005500375-2093	-	○	
5,5	0,375	0,413	93 AU 2093 /N3101	LSU	25005500375B-2093	-	●		
5,5	0,5	0,531	92 AU 9250	PI	560002273M00A	-	●		
5,5	0,5	0,55	93 AU 2093 /N3101	LSU	25005500500-2093	-	○		
5,5	0,563	0,593	92 AU 9250	PI	560002273000A	-	○		
5,5	0,563	0,618	93 AU 2093 /N3101	LSU	25005500562-2093	-	○		
5,5	0,563	0,618	93 AU 2093 /N3101	LSU	25005500562B-2093	-	○		
6,002	5,528	0,345	0,375	98 AU 928 /NBR	DISO-PAC	302-433-0001	-	●	
6,125	5,375	0,5	0,531	92 AU 9250	SYM	005397000A	-	○	
	5,5	0,313	0,344	93 AU 2093 /N3101	LSU	31205500-2093	-	○	
	5,5	0,375	0,406	92 AU 9250	SYM	005400000A	-	○	
	5,5	0,375	0,413	93 AU 2093 /N3101	LSU	31205500375-2093	-	○	
	5,5	0,625	0,656	92 AU 9250	SYM	005398000A	-	○	
	5,607	0,143	0,159	HT 2022	PolyHone 1704	561704-098	-	○	
	5,625	0,25	0,275	93 AU 2093 /N3101	LSU	25005625-2093	-	○	
	5,625	0,375	0,406	92 AU 9250	SYM	005403I00A	-	○	
6,25	5,625	0,563	0,618	93 AU 2093 /N3101	LSU	25005625562B-2093	-	○	
6,25	5	0,625	0,688	93 AU 2093 /N3101	LSU	62505000-2093	-	○	
	5,25	0,625	0,656	92 AU 9250	PI	002275000A	-	●	

D [inch]	d [inch]	H [inch]	L [inch]	Material	Design	Part No.	PU ¹⁾	US	EU
6,25	5,25	0,75	0,816	92 AU 9250	PI	002274000A	-	○	
	5,5	0,375	0,406	92 AU 9250	PI	002276100A	-	○	
	5,5	0,375	0,406	92 AU 9250	SYM	005402100A	-	●	
	5,5	0,375	0,413	93 AU 2093 / N3101	LSU	37505500-2093	-	○	
	5,5	0,5	0,531	92 AU 9250	SYM	005402000A	-	●	
	5,625	0,5	0,531	92 AU 9250	SYM	005405000A	-	●	
	5,625	0,625	0,656	92 AU 9250	SYM	005404000A	-	○	
	5,732	0,143	0,159	HT 2022	PolyHone 1704	561704-100	-	○	
	5,732	0,143	0,159	HT 2055	PolyHone 1704	561704-100-2055	-	○	
	5,75	0,25	0,275	93 AU 2093 / N3101	LSU	25005750-2093	-	○	
	5,75	0,625	0,656	92 AU 9250	PI	560002326000A	-	○	
5,75	0,625	0,656	92 AU 9250	SYM	560005522000A	-	○		
6,252	5,778	0,345	0,375	98 AU 928 / NBR	DISO-PAC	302-435-0001	-	○	
6,375	5,625	0,625	0,656	92 AU 9250	SYM	005407000A	-	○	
6,5	5,5	0,5	0,55	93 AU 2093 / N3101	LSU	50005500-2093	-	○	
	5,5	0,625	0,656	92 AU 9250	PI	002279000A	-	●	
	5,5	0,75	0,825	93 AU 2093 / N3101	LSU	50005500750B-2093	-	○	
	5,75	0,375	0,406	92 AU 9250	PI	560002280100A	-	●	
	5,75	0,375	0,413	93 AU 2093 / N3101	LSU	37505750-2093	-	○	
	5,75	0,5	0,531	92 AU 9250	PI	002281000A	-	○	
	5,75	0,5	0,531	92 AU 9250	SYM	005413000A	-	●	
	5,75	0,625	0,656	92 AU 9250	PI	560002280000A	-	●	
	5,75	0,625	0,656	92 AU 9250	SYM	005412000A	-	●	
	5,75	0,625	0,688	93 AU 2093 / N3101	LSU	37505750625B-2093	-	○	
	5,875	0,375	0,406	92 AU 9250	SYM	005417000A	-	○	
	5,982	0,143	0,159	HT 2022	PolyHone 1704	561704-104	-	○	
	5,982	0,143	0,159	HT 2055	PolyHone 1704	561704-104-2055	-	○	
	6	0,25	0,275	93 AU 2093 / N3101	LSU	25006000-2093	-	●	
	6	0,25	0,275	93 AU 2093 / N3101	LSU	25006000SQB-2093	-	○	
	6	0,375	0,406	92 AU 9250	SYM	005420100A	-	●	
	6	0,375	0,413	93 AU 2093 / N3101	LSU	25006000375B-2093	-	○	
6	0,45	0,495	93 AU 2093 / N3101	LSU	25006000450-2093	-	○		
6	0,563	0,593	92 AU 9250	PI	002282000A	-	○		
6	0,563	0,593	92 AU 9250	SYM	005420000A	-	●		
6	0,563	0,618	93 AU 2093 / N3101	LSU	25006000562B-2093	-	○		
6,502	6,028	0,345	0,375	98 AU 928 / NBR	DISO-PAC	302-437-0001	-	●	
6,625	6	0,313	0,344	93 AU 2093 / N3101	LSU	31206000-2093	-	○	
6,75	5,75	0,5	0,55	93 AU 2093 / N3101	LSU	50005750-2093	-	○	
	5,75	0,75	0,825	93 AU 2093 / N3101	LSU	50005750750B-2093	-	○	
	6	0,5	0,531	92 AU 9250	PI	002284000A	-	●	
	6	0,625	0,688	93 AU 2093 / N3101	LSU	37506000625B-2093	-	●	
	6,25	0,25	0,275	93 AU 2093 / N3101	LSU	25006250-2093	-	○	
	6,25	0,5	0,531	92 AU 9250	SYM	005423M00A	-	○	
	6,25	0,563	0,593	92 AU 9250	SYM	005423000A	-	○	
7	5,75	1	1,1	93 AU 2093 / N3101	LSU	625057501000B-2093	-	○	
	6	0,5	0,55	93 AU 2093 / N3101	LSU	50006000-2093	-	○	
	6	0,5	0,55	93 AU 2093 / N3101	LSU	50006000SQB-2093	-	○	
	6	0,625	0,656	92 AU 9250	SYM	005422000A	-	●	
	6	0,75	0,781	92 AU 9250	SYM	005421000A	-	●	

D [inch]	d [inch]	H [inch]	L [inch]	Material	Design	Part No.	PU ¹⁾	US	EU
	6	0,75	0,816	92 AU 9250	PI	002285Y00A	-	○	
	6	0,75	0,816	92 AU 9250	PI	002285000A	-	●	
	6	0,75	0,825	93 AU 2093 /N3101	LSU	50006000750B-2093	-	○	
	6,17	0,345	0,375	98 AU 928 /NBR	DISO-PAC	302-439-0011	-	○	
	6,25	0,375	0,406	92 AU 9250	PI	560002287100A	-	●	
	6,25	0,5	0,531	92 AU 9250	PI	560002288000A	-	●	
	6,25	0,5	0,531	92 AU 9250	SYM	005425000A	-	●	
	6,25	0,5	0,55	93 AU 2093 /N3101	LSU	37506250500B-2093	-	○	
	6,25	0,625	0,656	92 AU 9250	PI	560002287000A	-	●	
	6,25	0,625	0,656	92 AU 9250	SYM	005424000A	-	●	
7	6,25	0,625	0,688	93 AU 2093 /N3101	LSU	37506250625B-2093	-	○	
	6,375	0,313	0,344	93 AU 2093 /N3101	LSU	31206375-2093	-	○	
	6,482	0,143	0,159	HT 2022	PolyHone 1704	561704-112	-	●	
	6,482	0,143	0,159	HT 2055	PolyHone 1704	561704-112-2055	-	○	
	6,5	0,25	0,275	93 AU 2093 /N3101	LSU	25006500-2093	-	●	
	6,5	0,25	0,275	93 AU 2093 /N3101	LSU	25006500SQB-2093	-	○	
	6,5	0,375	0,406	92 AU 9250	SYM	005428100A	-	●	
	6,5	0,375	0,413	93 AU 2093 /N3101	LSU	25006500375B-2093	-	○	
	6,5	0,5	0,531	92 AU 9250	SYM	005428M00A	-	●	
	6,5	0,563	0,593	92 AU 9250	SYM	005428000A	-	○	
7,002	6,528	0,345	0,375	98 AU 928 /NBR	DISO-PAC	302-439-0001	-	○	
	6,5	0,375	0,413	93 AU 2093 /N3101	LSU	37506500-2093	-	○	
	6,5	0,5	0,531	92 AU 9250	PI	002293000A	-	●	
	6,5	0,5	0,531	92 AU 9250	SYM	005430000A	-	○	
	6,5	0,5	0,55	93 AU 2093 /N3101	LSU	37506500500-2093	-	○	
	6,5	0,625	0,656	92 AU 9250	PI	002292000A	-	○	
	6,5	0,625	0,656	92 AU 9250	SYM	005429000A	-	●	
7,25	6,5	0,625	0,688	93 AU 2093 /N3101	LSU	37506500625B-2093	-	●	
	6,625	0,313	0,344	93 AU 2093 /N3101	LSU	31206625-2093	-	○	
	6,732	0,143	0,159	HT 2022	PolyHone 1704	561704-116	-	○	
	6,732	0,143	0,159	HT 2055	PolyHone 1704	561704-116-2055	-	○	
	6,75	0,25	0,275	93 AU 2093 /N3101	LSU	25006750-2093	-	○	
	6,75	0,563	0,593	92 AU 9250	SYM	005433000A	-	○	
	6,75	0,563	0,618	93 AU 2093 /N3101	LSU	25006750562B-2093	-	○	
7,375	6,75	0,625	0,688	93 AU 2093 /N3101	LSU	31206750625B-2093	-	○	
	6,5	0,5	0,55	93 AU 2093 /N3101	LSU	50006500-2093	-	○	
	6,5	0,594	0,625	92 AU 9250	PI	002294Q00A	-	○	
	6,5	0,625	0,656	92 AU 9250	PI	002295000A	-	●	
	6,5	0,75	0,781	92 AU 9250	SYM	005431000A	-	○	
	6,5	0,75	0,816	92 AU 9250	PI	002294000A	-	○	
	6,5	0,75	0,825	93 AU 2093 /N3101	LSU	50006500750B-2093	-	●	
7,5	6,75	0,5	0,531	92 AU 9250	PI	002297000A	-	○	
	6,75	0,5	0,531	92 AU 9250	SYM	005435000A	-	●	
	6,75	0,625	0,656	92 AU 9250	PI	560002296000A	-	●	
	6,982	0,143	0,159	HT 2022	PolyHone 1704	561704-120	-	○	
	6,982	0,143	0,159	HT 2055	PolyHone 1704	561704-120-2055	-	○	
	7	0,563	0,593	92 AU 9250	SYM	005438000A	-	●	
	7	0,563	0,618	93 AU 2093 /N3101	LSU	25007000562B-2093	-	○	
7,75	6,75	0,75	0,825	93 AU 2093 /N3101	LSU	50006750750B-2093	-	○	
	7	0,5	0,531	92 AU 9250	SYM	005440000A	-	●	

D [inch]	d [inch]	H [inch]	L [inch]	Material	Design	Part No.	PU ¹⁾	US	EU	
7,75	7	0,625	0,656	92 AU 9250	SYM	005439000A	-	●		
	7	0,625	0,688	93 AU 2093 /N3101	LSU	37507000625B-2093	-	○		
	7,25	0,563	0,593	92 AU 9250	SYM	005443000A	-	○		
8	7	0,5	0,531	92 AU 9250	PI	002303M00A	-	●		
	7	0,5	0,55	93 AU 2093 /N3101	LSU	50007000-2093	-	○		
	7	0,625	0,656	92 AU 9250	PI	002304000A	-	○		
	7	0,625	0,656	92 AU 9250	SYM	005442000A	-	○		
	7	0,75	0,781	92 AU 9250	SYM	005441000A	-	○		
	7	0,75	0,816	92 AU 9250	PI	002303000A	-	●		
	7	0,75	0,825	93 AU 2093 /N3101	LSU	50007000750-2093	-	●		
	7	0,75	0,825	93 AU 2093 /N3101	LSU	50007000750B-2093	-	○		
	7,25	0,375	0,406	92 AU 9250	PI	560002306I00A	-	●		
	7,25	0,375	0,413	93 AU 2093 /N3101	LSU	37507250-2093	-	○		
	7,25	0,5	0,531	92 AU 9250	PI	560002306000A	-	●		
	7,25	0,5	0,531	92 AU 9250	SYM	005445000A	-	●		
	7,25	0,5	0,55	93 AU 2093 /N3101	LSU	37507250500-2093	-	○		
	7,25	0,625	0,656	92 AU 9250	PI	560002305000A	-	●		
	7,25	0,625	0,656	92 AU 9250	SYM	005444000A	-	○		
	7,25	0,625	0,688	93 AU 2093 /N3101	LSU	37507250625B-2093	-	○		
	7,375	0,313	0,344	93 AU 2093 /N3101	LSU	31207375-2093	-	○		
	7,482	0,143	0,159	HT 2022	PolyHone 1704	561704-128	-	○		
	7,482	0,143	0,159	HT 2055	PolyHone 1704	561704-128-2055	-	○		
	7,5	0,25	0,275	93 AU 2093 /N3101	LSU	25007500-2093	-	●		
	7,5	0,25	0,275	93 AU 2093 /N3101	LSU	25007500SQB-2093	-	○		
	7,5	0,375	0,413	93 AU 2093 /N3101	LSU	25007500375B-2093	-	●		
	7,5	0,563	0,593	92 AU 9250	SYM	005448000A	-	○		
	7,5	0,563	0,618	93 AU 2093 /N3101	LSU	25007500562-2093	-	●		
	7,5	0,563	0,618	93 AU 2093 /N3101	LSU	25007500562B-2093	-	○		
	8,25	7,5	0,375	0,413	93 AU 2093 /N3101	LSU	37507500-2093	-	○	
		7,5	0,625	0,688	93 AU 2093 /N3101	LSU	37507500625B-2093	-	○	
7,75		0,563	0,618	93 AU 2093 /N3101	LSU	25007750562B-2093	-	○		
8,5	7,5	0,625	0,656	92 AU 9250	PI	002308000A	-	●		
	7,5	0,75	0,781	92 AU 9250	SYM	005451000A	-	●		
	7,5	0,75	0,816	92 AU 9250	PI	002307000A	-	●		
	7,75	0,375	0,413	93 AU 2093 /N3101	LSU	37507750-2093	-	○		
	7,75	0,5	0,531	92 AU 9250	SYM	005455000A	-	●		
	7,875	0,625	0,688	93 AU 2093 /N3101	LSU	31207875625B-2093	-	○		
	7,982	0,143	0,159	HT 2022	PolyHone 1704	561704-136	-	○		
	7,982	0,143	0,159	HT 2055	PolyHone 1704	561704-136-2055	-	○		
	8	0,25	0,275	93 AU 2093 /N3101	LSU	25008000-2093	-	○		
	8	0,25	0,275	93 AU 2093 /N3101	LSU	25008000SQB-2093	-	○		
	8	0,375	0,413	93 AU 2093 /N3101	LSU	25008000375B-2093	-	○		
	8	0,563	0,593	92 AU 9250	SYM	005458000A	-	○		
	8	0,563	0,618	93 AU 2093 /N3101	LSU	25008000562B-2093	-	○		
	8,75	7,75	0,75	0,781	92 AU 9250	SYM	005456000A	-	○	
		8	0,5	0,531	92 AU 9250	SYM	005460000A	-	●	
8		0,5	0,55	93 AU 2093 /N3101	LSU	37508000500B-2093	-	○		
8		0,625	0,688	93 AU 2093 /N3101	LSU	37508000625B-2093	-	○		
9	8	0,5	0,55	93 AU 2093 /N3101	LSU	50008000-2093	-	○		
	8	0,5	0,55	93 AU 2093 /N3101	LSU	50008000SQB-2093	-	○		

D [inch]	d [inch]	H [inch]	L [inch]	Material	Design	Part No.	PU ¹⁾	US	EU	
9	8	0,625	0,656	92 AU 9250	PI	002310000A	-	○		
	8	0,625	0,656	92 AU 9250	SYM	005462000A	-	●		
	8	0,75	0,781	92 AU 9250	SYM	005461000A	-	●		
	8	0,75	0,816	92 AU 9250	PI	002309000A	-	●		
	8	0,75	0,825	93 AU 2093 /N3101	LSU	50008000750B-2093	-	○		
	8,25	0,5	0,531	92 AU 9250	SYM	005465000A	-	●		
	8,25	0,625	0,688	93 AU 2093 /N3101	LSU	37508250625B-2093	-	○		
	8,482	0,143	0,159	HT 2022	PolyHone 1704	561704-144	-	○		
	8,482	0,143	0,159	HT 2055	PolyHone 1704	561704-144-2055	-	○		
	8,5	0,25	0,275	93 AU 2093 /N3101	LSU	25008500-2093	-	○		
9,25	8,5	0,375	0,406	92 AU 9250	SYM	005468100A	-	○		
	8,25	0,5	0,55	93 AU 2093 /N3101	LSU	50008250-2093	-	○		
	8,5	0,375	0,413	93 AU 2093 /N3101	LSU	37508500-2093	-	○		
	8,5	0,625	0,656	92 AU 9250	SYM	005469000A	-	○		
	8,5	0,625	0,688	93 AU 2093 /N3101	LSU	37508500625B-2093	-	○		
9,5	8,75	0,25	0,275	93 AU 2093 /N3101	LSU	25008750-2093	-	○		
	8,5	0,594	0,625	92 AU 9250	SYM	005471Q00A	-	○		
	8,5	0,75	0,825	93 AU 2093 /N3101	LSU	50008500750B-2093	-	○		
	8,982	0,143	0,159	HT 2022	PolyHone 1704	561704-152	-	○		
9,75	8,982	0,143	0,159	HT 2055	PolyHone 1704	561704-152-2055	-	○		
	9	0,25	0,275	93 AU 2093 /N3101	LSU	25009000-2093	-	○		
	8,75	0,75	0,825	93 AU 2093 /N3101	LSU	50008750750B-2093	-	○		
	9	0,375	0,413	93 AU 2093 /N3101	LSU	37509000-2093	-	○		
10	9	0,625	0,688	93 AU 2093 /N3101	LSU	37509000625B-2093	-	○		
	9,25	0,25	0,275	93 AU 2093 /N3101	LSU	25009250-2093	-	○		
	9	0,5	0,55	93 AU 2093 /N3101	LSU	50009000-2093	-	○		
	9	0,59	0,625	92 AU 9250	SYM	005487Q00A	-	○		
	9	0,625	0,656	92 AU 9250	PI	002314000A	-	●		
	9	0,625	0,656	92 AU 9250	SYM	005481000A	-	●		
	9	0,75	0,781	92 AU 9250	SYM	005480000A	-	○		
	9	0,75	0,816	92 AU 9250	PI	002313000A	-	●		
	9	0,75	0,825	93 AU 2093 /N3101	LSU	50009000750-2093	-	●		
	9	0,75	0,825	93 AU 2093 /N3101	LSU	50009000750B-2093	-	●		
	9,25	0,375	0,413	93 AU 2093 /N3101	LSU	37509250-2093	-	●		
	9,25	0,5	0,55	93 AU 2093 /N3101	LSU	37509250500B-2093	-	○		
	9,25	0,625	0,688	93 AU 2093 /N3101	LSU	37509250625-2093	-	○		
	9,25	0,625	0,688	93 AU 2093 /N3101	LSU	37509250625B-2093	-	●		
10,25	9,375	0,625	0,688	93 AU 2093 /N3101	LSU	31209375625B-2093	-	○		
	9,482	0,143	0,159	HT 2022	PolyHone 1704	561704-160	-	○		
	9,482	0,143	0,159	HT 2055	PolyHone 1704	561704-160-2055	-	○		
	9,5	0,25	0,275	93 AU 2093 /N3101	LSU	25009500-2093	-	●		
	9,5	0,563	0,618	93 AU 2093 /N3101	LSU	25009500562-2093	-	○		
	9,5	0,563	0,618	93 AU 2093 /N3101	LSU	25009500562B-2093	-	○		
	10,25	9,5	0,625	0,688	93 AU 2093 /N3101	LSU	37509500625B-2093	-	○	
	10,5	9,5	0,75	0,825	93 AU 2093 /N3101	LSU	50009500750B-2093	-	○	
		10	0,563	0,618	93 AU 2093 /N3101	LSU	25010000562B-2093	-	●	
	11	10	0,625	0,656	92 AU 9250	PI	002318000A	-	○	
10		0,625	0,656	92 AU 9250	SYM	005488000A	-	○		
10		0,75	0,781	92 AU 9250	SYM	005487000A	-	●		
10		0,75	0,816	92 AU 9250	PI	002317000A	-	●		

D [inch]	d [inch]	H [inch]	L [inch]	Material	Design	Part No.	PU ¹⁾	US	EU
11	10	0,75	0,825	93 AU 2093 / N3101	LSU	50010000750B-2093	-	●	
11,5	11	0,25	0,275	93 AU 2093 / N3101	LSU	25011000-2093	-	○	
	11	0,5	0,55	93 AU 2093 / N3101	LSU	50011000-2093	-	●	
	11	0,59	0,625	92 AU 9250	SYM	005489Q00A	-	●	
	11	0,625	0,656	92 AU 9250	PI	002320000A	-	●	
12	11	0,75	0,781	92 AU 9250	SYM	005489000A	-	●	
	11	0,75	0,816	92 AU 9250	PI	002319000A	-	●	
	11	0,75	0,825	93 AU 2093 / N3101	LSU	50011000750B-2093	-	○	
	11,25	0,375	0,413	93 AU 2093 / N3101	LSU	37511250-2093	-	●	
	11,25	0,625	0,688	93 AU 2093 / N3101	LSU	37511250625-2093	-	○	

MONTAGEHILFE | MONTAJ YARDIM POMOC MONTAŻOWA | РУКОВОДСТВО ПО МОНТАЖУ

DE KOLBENDICHTUNGEN

Was nützt die beste Dichtung, wenn sie nicht richtig eingebaut oder beim Einbau beschädigt wird? Damit dies nicht passiert, stellt Ihnen Freudenberg Sealing Technologies eine maßgeschneiderte Palette von Montagewerkzeugen zur Verfügung. Die einwandfreie Montage ist entscheidend für die Leistungsfähigkeit und Standzeit einer Dichtung und stellt damit ein wesentliches Qualitätsmerkmal dar. Mit den Einbauhilfen von Freudenberg Sealing Technologies

- vermeiden Sie grundlegende Einbaufehler,
- vermeiden Sie Beschädigungen der Dichtkante bei der Montage,
- erhöhen Sie die Standzeit der Dichtung,
- sparen Sie Zeit und Kosten.

Für Kolbendichtungen haben sich in der Praxis unabhängig vom Werkstoff zwei Einbauhilfen bewährt: Die Montage mit Spreizdüse und Montagekegel beziehungsweise der Einbau mit Montagebändern und Kalibrierhülse.

1. Einbau mit Spreizdüse und Montagekegel

Bei zweiteiligen Kolbendichtungen ist in zwei Schritten zunächst der Anpressring, anschließend der Profiling zu montieren. Eine Kalibrierung der Kolbendichtung ist danach nicht erforderlich.

Die Montage von Anpressring und Profiling verläuft jeweils nach dem demselben Muster:

- Den Montagekegel auf den Kolben aufsetzen.
- Den Anpressring/Profiling auf den Montagekegel auflegen.
- Den Anpressring/Profiling mit der Spreizhülse über den Konus hinweg aufdehnen und in die Nut einsprengen.

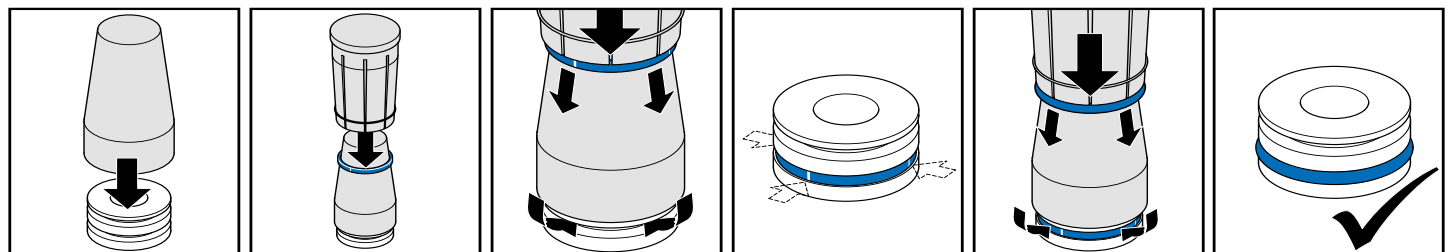

1. Einbau mit Spreizdüse und Montagekegel | Genişletme ağız ve montaj konisi ile montaj |
Instalacja za pomocą tuleji rozszerzającej oraz stożka mocującego | Установка с помощью адаптера расширения и монтажного конуса

2. Einbau mit Montageband und Kalibrierhülse

Kolbendichtungen lassen sich auch sehr gut mit Hilfe zirka 30 Millimeter breiter Montagebänder aus reißfestem Nylon montieren. Dabei werden die Ringe mit jeweils zwei Montagebändern in zwei Stufen übergeknöpft. PTFE-Profilringe sollten hierzu vor der Montage in Wasser oder Öl auf zirka 80°C erwärmt werden. Abschließend wird die Kolbendichtung mit Hilfe einer Kalibrierhülse in der Kolbenbohrung kalibriert.

TR PİSTON SIZDIRMAZLIK ELEMANLARI

Doğru montaj yapılmayan ve ya montaj sırasında hasar gören sızdırmazlık elemanı en iyi sızdırmazlık elemanı olsa bile neye yarar? Bunun olmaması için Freudenberg Sealing Technologies size özel hazırlanmış montaj takımları sunmaktadır. Bir sızdırmazlık elemanının performansı ve dayanım süresi için kusursuz montaj çok önemlidir ve önemli bir kalite özelliğidir. Freudenberg Sealing Technologies montaj yardımcıları ile

- temel montaj hatalarından kaçınabilirsiniz.
- montaj sırasında sızdırmazlık dudağına zarar vermeyi önlersiniz.
- sızdırmazlık elemanının dayanım süresini artırırsınız.
- zamandan ve maliyetten tasarruf etmiş olursunuz.

Piston sızdırmazlık elemanları montajı için, malzmeden bağımsız olarak iki metod denenmiştir ve pratik olarak faydalı olduğu kanıtlanmıştır: Germe memesi ve montaj konisi ile yapılan montaj ve ya montaj bantları ve kalibrasyon kovanları ile yapılan montaj.

1. Genişletme aparatı ve montaj konisi ile montaj

İki parçalı piston sızdırmazlık elamanlarının montajı iki adımda yapılır, önce o-ring sonra da kayıcı ring monte edilir. Böylece piston sızdırmazlık elemanının daha sonra kalibre edilmesine gerek kalmaz.

O-ring ve elastomer kayıcı ringin montajı aynı örneğe göre gerçekleşir.

- Montaj konisini piston üzerine geçiriniz.
- O-ring / kayacı ring montaj konisinin üzerine koyunuz.
- O-ring / kayacı ringi genişletme aparatı ile koninin üzerinden esnetin ve yuvanın içerisinde gerin.

2. Montaj bandı ve kalibrasyon kovani ile montaj

Piston sızdırmazlık elamanları yakl.30 milimetre genişliğindeki yırtılmaya dayanıklı naylondan montaj bantları yardımıyla çok başarılı biçimde monte edilebilir. Bu sırada halkalar iki montaj bandı ile iki kademede kolayca geçirilebilir. PTFE profil halkaları bunun için monte edilmeden önce su ve ya yağ içerisinde yakl.80°C ısıtılmalıdır. Son olarak da piston sızdırmazlık elemanı bir kalibrasyon kovani yardımıyla piston yuvasında kalibre edilir.

PL USZCZELNIENIA TŁOKA

Cóż jest warta nawet najlepsza uszczelka, jeśli nie zostanie prawidłowo zainstalowana lub ulegnie uszkodzeniu podczas montażu? Aby tak się nie stało, firma Freudenberg Sealing Technologies udostępnia Państwu specjalistyczny zestaw narzędzi montażowych. Prawidłowy montaż jest kluczowym czynnikiem wpływającym na funkcjonowanie uszczelnienia oraz jego długą żywotność. Dzięki narzędziom do montażu oferowanym przez firmę Freudenberg Sealing Technologies

- unika się podstawowych błędów montażowych,
- unika się uszkodzenia krawędzi uszczelniających podczas montażu,
- wydłuża się żywotność uszczelnienia,
- w konsekwencji oszczędza się czas i ogranicza koszty.

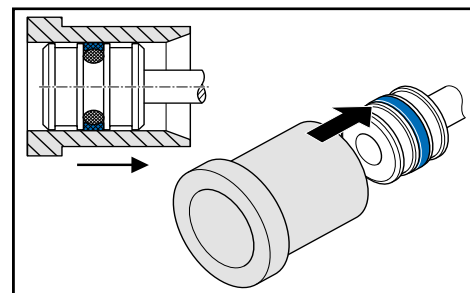
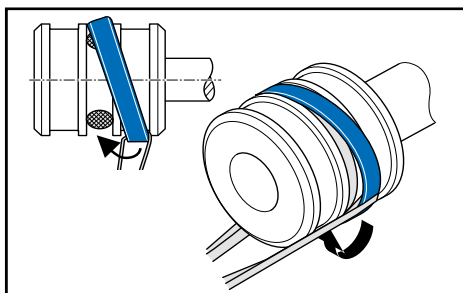
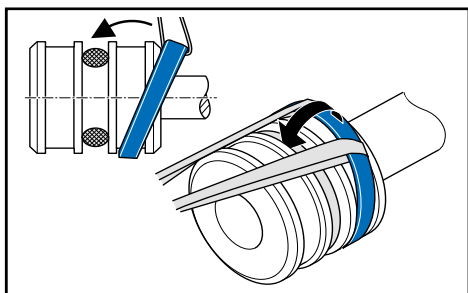

2. Einbau mit Montageband und Kalibrierhülse | Montaj bandı ve kalibrasyon kolu ile montaj |

Instalacja za pomocą taśmy montażowej i tulei kalibracyjnej | Установка с помощью монтажной ленты и калибровочной втулки

W montażu uszczelnień tłoka sprawdzają się dwie metody i to niezależnie od materiału, z którego są one wykonane. Montaż wykonuje się za pomocą tulei rozprężnej i stożka montażowego względnie za pomocą taśm montażowych, a następnie tulejki kalibracyjnej.

1. Zabudowa za pomocą popychacza i stożka montażowego

W przypadku dwuczęściowych uszczelnień tłoka (np. SIMKO 300) należy w dwóch krokach zamontować najpierw pierścień sprężynujący, a następnie pierścień uszczelniający. Kalibracja uszczelnienia tłoka nie jest konieczna.

Montaż pierścienia sprężynującego i pierścienia uszczelniającego przebiega według tego samego schematu:

- Stożek montażowy nałożyć na tłok.
- Pierścień sprężynujący/pierścień uszczelniający nałożyć na stożek montażowy.
- Za pomocą popychacza naciągnąć pierścień sprężynujący/pierścień uszczelniający na stożek i umieścić w rowku.

2. Zabudowa za pomocą taśmy montażowej i tulejki kalibracyjnej

Uszczelnienia tłoka można z łatwością montować za pomocą taśm montażowych o szerokości ok. 30 milimetrów wykonanych z odpornego na zerwanie nylonu. Pierścienie wciska się za pomocą dwóch taśm montażowych w dwóch poziomach. Pierścienie profilowane PTFE należy w tym celu przed montażem ogrzać w oleju do temperatury około 80°C. Następnie uszczelnienie tłoka kalibruje się za pomocą tulei kalibracyjnej.

RU ПОРШНЕВЫЕ УПЛОТНЕНИЯ

Какая польза от самого лучшего уплотнения, если оно неправильно установлено или повреждено при монтаже? Чтобы этого не случилось, «Фройденберг Силинг Технолджис» предлагает Вам ассортимент монтажных инструментов.

Безупречный монтаж в решающей степени влияет на эффективность и срок службы уплотнения и является, тем самым, существенным показателем качества.

Монтажные инструменты «Фройденберг Силинг Технолоджис» позволяют Вам

- не допускать основных ошибок при монтаже,
- избегать при монтаже повреждения уплотняющей кромки,
- продлить срок службы уплотнения,
- сэкономить время и затраты.

Практика показала, что при монтаже поршневых уплотнений, вне зависимости от их материала, применяются два метода: монтаж с использованием адаптера расширения и монтажного конуса и с использованием монтажных лент и калибровочной втулки.

1. Монтаж уплотнения с использованием адаптера расширения и монтажного конуса













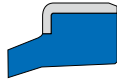

Монтаж поршневых уплотнений, состоящих из двух элементов, осуществляется в два этапа: вначале устанавливается прижимное кольцо, а затем профильное кольцо. Последующая калибровка поршневого уплотнения при этом не требуется.

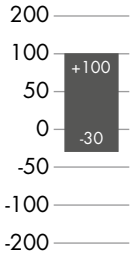
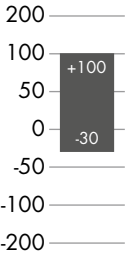
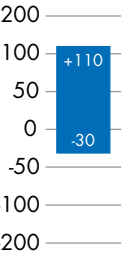
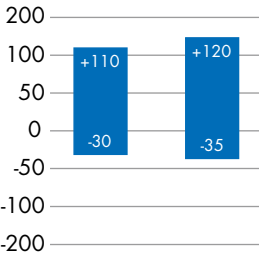
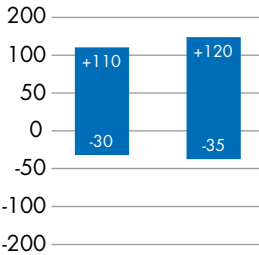
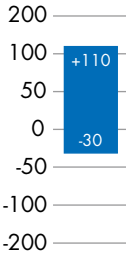
Монтаж прижимного кольца и профильного уплотнительного кольца производится по одной схеме:

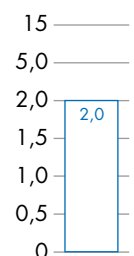
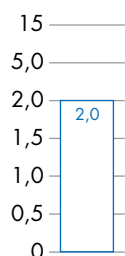
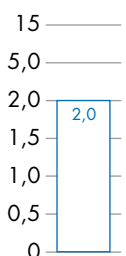
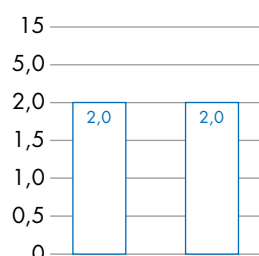
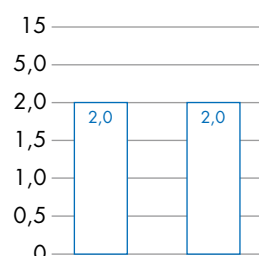
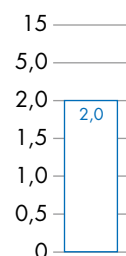









- Установить монтажный конус на поршень.
- Установить прижимное кольцо/профильное уплотнительное кольцо на монтажный конус.
- Протянуть с помощью адаптера расширения прижимное кольцо/профильное уплотнительное кольцо по конусу и втолкнуть их в канавку.



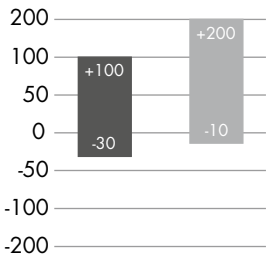
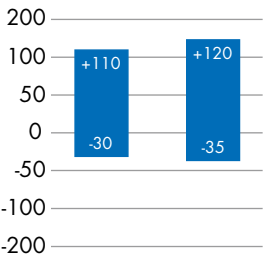
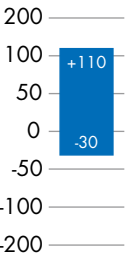
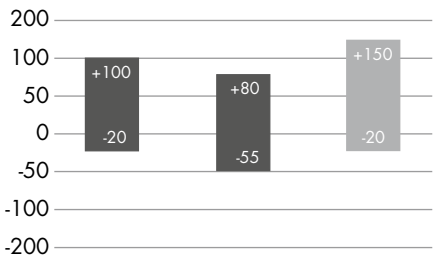
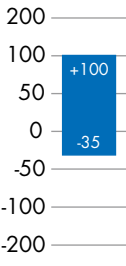
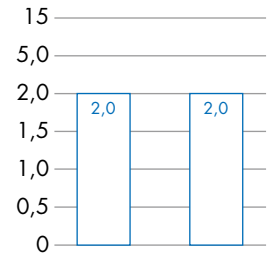
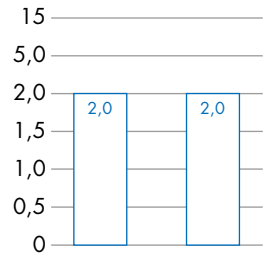
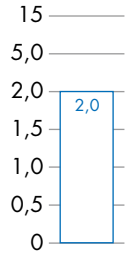
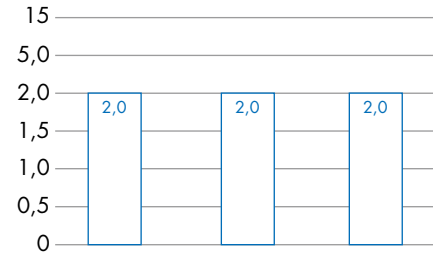
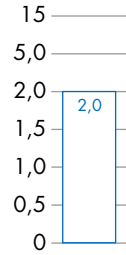





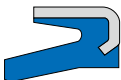

2. Монтаж уплотнения с помощью монтажной ленты и калибровочной втулки

Быстрый и легкий монтаж поршневых уплотнений может также проводиться при помощи монтажных лент из прочного нейлона шириной около 30 миллиметров. Монтаж каждого из колец производится одно за другим в два этапа; каждое кольцо монтируется при помощи двух лент. Перед монтажом профильное уплотнительное кольцо из ПТФЭ нагревается в воде или в масле примерно до 80°C. После монтажа поршневое уплотнение калибруется в канавке при помощи калибровочной втулки.

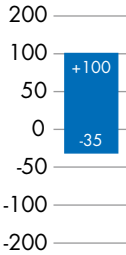
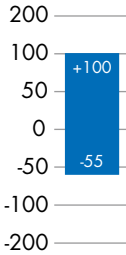
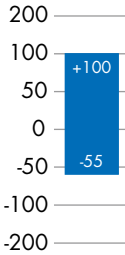
Type	AS	ASOB	AUPS	AUAS		AUAS R		AUASOB
Standard	ISO	ISO	ISO	ISO		ISO		ISO
Shape								
Compound	NBR 88 NBR 101 88 NBR 99035	NBR 88 NBR 101	Polyurethan 94 AU 925	Polyurethan 94 AU 925	Polyurethan 94 AU 30000	Polyurethan 94 AU 925	Polyurethan 94 AU 30000	Polyurethan 94 AU 925
								
								
Applications								

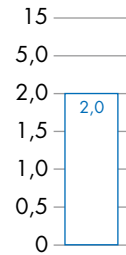
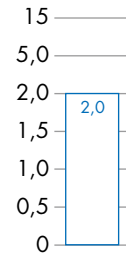
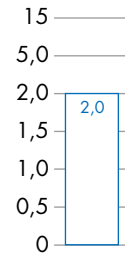
Bitte beachten Sie unsere allgemeinen Konstruktionshinweise in → Technisches Handbuch
 Daha detaylı montaj bilgisi için → Bkz. Technical Manual
 W celu zaznajomienia się z ogólnymi uwagami proszę skorzystać z Instrukcji
 Общие технические рекомендации см. → Техническое руководство

P 6		PU 5		PU 6	DKH			DKI
ISO		ISO		ISO	JIS			JIS
								
NBR 85 NBR B247	FKM 85 FKM K664	Polyurethan 95 AU V149	Polyurethan 94 AU 30000	Polyurethan 95 AU V149	NBR 80 A104 80 A795	NBR 80 A980	FKM 80 F975	Polyurethan 94 U801
 <p>Temperature range: -30 to +200</p>		 <p>Temperature range: -35 to +120</p>		 <p>Temperature range: -30 to +110</p>	 <p>Temperature range: -55 to +150</p>			 <p>Temperature range: -35 to +100</p>
 <p>Surface roughness: 2,0</p>		 <p>Surface roughness: 2,0</p>		 <p>Surface roughness: 2,0</p>	 <p>Surface roughness: 2,0</p>			 <p>Surface roughness: 2,0</p>
								

Type	DSI	DWI	DWIR	
Standard	JIS	JIS	JIS	
Shape				
Compound	Polyurethan 94 U801	Polyurethan 95 U801	Polyurethan 95 U801	
	 <p>200 — 100 — 50 — 0 — -50 — -100 — -200 —</p> <p>+100 -35</p>	 <p>200 — 100 — 50 — 0 — -50 — -100 — -200 —</p> <p>+100 -55</p>	 <p>200 — 100 — 50 — 0 — -50 — -100 — -200 —</p> <p>+100 -55</p>	
	 <p>15 — 5,0 — 2,0 — 1,5 — 1,0 — 0,5 — 0 —</p> <p>2,0</p>	 <p>15 — 5,0 — 2,0 — 1,5 — 1,0 — 0,5 — 0 —</p> <p>2,0</p>	 <p>15 — 5,0 — 2,0 — 1,5 — 1,0 — 0,5 — 0 —</p> <p>2,0</p>	
Applications				

Bitte beachten Sie unsere allgemeinen Konstruktionshinweise in → Technisches Handbuch

Daha detaylı montaj bilgisi için → Bkz. Technical Manual

W celu zaznajomienia się z ogólnymi uwagami proszę skorzystać z Instrukcji

Общие технические рекомендации см. → Техническое руководство

EINFACH WIRKENDE ABSTREIFER | TEK ETKILI SIYIRICILAR ZGARNIACZE POJEDYNCZE | ГРЯЗЕСЪЕМНИКИ ОДНОСТОРОННЕГО ДЕЙСТВИЯ

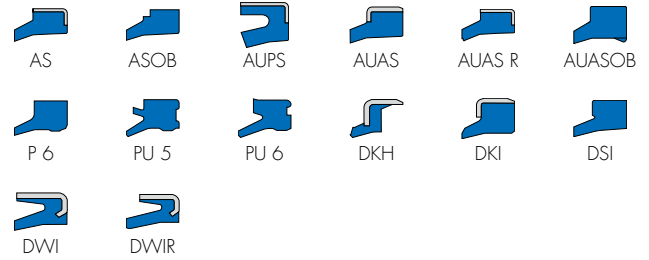
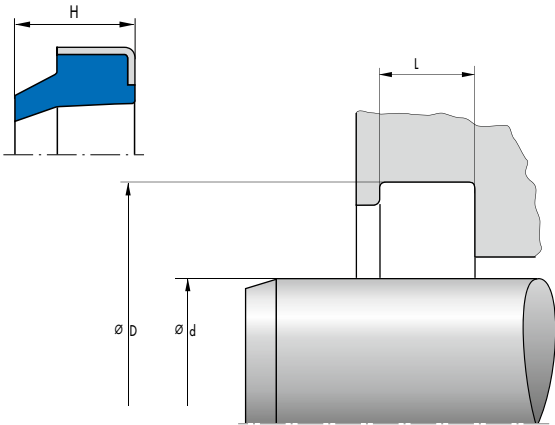

Wenn Sie Ihre Dichtung nicht finden können – Ihre Lösung auf Seite 12
Aradığınız ürünü bulamadığınız takdirde – çözümünüz sayfa 12
Jeżeli nie możecie Państwo znaleźć uszczelki – rozwiązanie znajduje się na stronie 12
Вы не можете подобрать необходимое уплотнение? – Решение на странице 12

1) IP = Industriepackung | Endüstriyel ambalaj | Opakowania przemysłowe | Производственная тара
SP = Einzelpackung | Tek bir Paket | Pojedyncze opakowanie | Single Pack

● Auf Lager | Stoklarda mevcuttur | Dostępne w magazynie | Имеется в наличии на складе
○ Auf Anfrage | Talep üzerine | Na zapytanie | По запросу

d [mm]	D [mm]	H [mm]	L [mm]	Material	Design	Part No.	PU ¹⁾	US	EU
6	13	4,5	3	88 NBR 101	AS	24801 40421692	IP SP	○	● ●
	14	7	4,8	94 AU 925	AUASOB	401478	–		○
6,3	14,3	6	5	U801	DSI	FG0000-D0	–	○	
	16	7	5	U801	DKI	FD0064-A0	–	○	
7,1	17	7	5	U801	DKI	FD0095-A0	–	○	
	16	6	5	U801	DSI	FG0002-D0	–	○	
8	16	7	4	88 NBR 101	ASOB	401496 40421947	IP SP		● ●
	16	7	4,8	94 AU 925	AUASOB	401479	–		○
	18	7	5	U801	DKI	FD0142-A0	–	○	
9	22	4,5	3	88 NBR 101	AS	24802 40421693	IP SP	○	● ●
	17	6	5	U801	DSI	FG0003-D0	–	○	
10	19	7	5	U801	DKI	FD0199-A0	–	○	
	16	4,5	3	88 NBR 99035	AS	454478 40422000	IP SP		● ●
10	18	6	5	U801	DSI	FG0004-D0	–	○	
	18	7	4	88 NBR 101	ASOB	401500 40421948	IP SP		● ●
	18	7	4,8	94 AU 925	AUASOB	401486 40421946	IP SP		● ●
	20	7	5	A795	DKH	AR0258-E5	–	○	
	20	7	5	U801	DKI	FD0258-A0	–	○	
	20	8	5	88 NBR 101	AS	12654 40421118	IP SP		● ●
11,2	20	8	5	94 AU 925	AUAS	12659 40421120	IP SP		● ●
	19,2	6	5	U801	DSI	FG0005-D0	–	○	
12	21	7	5	U801	DKI	FD0332-A0	–	○	
	18	5	3,5	88 NBR 99035	AS	457403 40422035	IP SP	○	● ●
	18,6	5,3	3,8	95 AU V149	PU 6	24375925	–		○
	20	4,8	7	94 AU 925	AUASOB	49065432	IP		●

d [mm]	D [mm]	H [mm]	L [mm]	Material	Design	Part No.	PU ¹⁾	US	EU
12	20	6	4	88 NBR 99035	AS	454486 40422001	IP SP		● ●
	20	6	4	94 AU 925	AUAS	24916 40421731	IP SP		● ●
	22	8	5	88 NBR 101	AS	12655 40421119	IP SP		● ●
	22	8	5	94 AU 925	AUAS	12660 40421121	IP SP		● ●
12,5	20,5	6	5	U801	DSI	FG0006-D0	-	○	
	23	7	5	U801	DKI	FD0412-A0	-	○	
14	20,6	5,3	3,8	95 AU V149	PU 6	24375926	-		○
	22	4	3	88 NBR 101	AS	36550 40421750	IP SP		● ●
	22	6	5	U801	DSI	FG0007-D0	-	○	
	22	7	4,8	94 AU 925	AUASOB	351680 40421926	IP SP		● ●
	24	7	5	U801	DKI	FD0513-A0	-	○	
	25	8	5	94 AU 925	AUAS	35853 40421747	IP SP	○	● ●
15	23	6	5	U801	DSI	FG0008-D0	-	○	
	23	7	4	88 NBR 101	ASOB	401504 40421949	IP SP		● ●
	25	7	5	A795	DKH	AR0586-E5	-	○	
	25	7	5	U801	DKI	FD0586-A0	-	○	
	25	8	5	88 NBR 101	AS	24805 40421694	IP SP	○	● ●
	25	8	5	94 AU 925	AUAS	12662 40421122	IP SP		● ●
16	22	4	3	88 NBR 99035	AS	454489 40422002	IP SP	○	● ●
	22	4	3	88 NBR 99035	AS	49006192 40422524	IP SP		● ●
	22	4	3	94 AU 925	AUAS	24910 40421729	IP SP		● ●
	22,6	5,3	3,8	95 AU V149	PU 6	24375927	-		○
	24	6	5	U801	DSI	FG0011-D0	-	○	
	24	7	4	95 AU V149	PU 5	24314499 40422427	IP SP		● ●
	24	7	4	94 AU 30000	PU 5	49334336	-		○
	24	7	4,8	94 AU 925	AUASOB	336668 40421916	IP SP		● ●
	24	7,8	5	95 AU V149	PU 5	24314500 40422428	IP SP		● ●
	24,6	7	5,3	85 FKM K664	P 6	24045457	-		○
	26	7	5	U801	DKI	FD0677-A0	-	○	
	26	8	5	88 NBR 99035	AS	454490 40422003	IP SP		● ●
	26	8	5	94 AU 925	AUAS	12664 40421123	IP SP		● ●
	18	24,6	5,3	3,8	95 AU V149	PU 6	24375928	-	
26		6	5	U801	DSI	FG0013-D0	-	○	
26		7	4	95 AU V149	PU 5	24314501 40422429	IP SP		● ●
26		7	4	94 AU 30000	PU 5	49334337	-		○
26		7	4,8	94 AU 925	AUASOB	351681 40421927	IP SP		● ●
26		7,8	5	95 AU V149	PU 5	24314502	-		○
28		7	5	88 NBR 99035	AS	454491 40422004	IP SP		● ●

d [mm]	D [mm]	H [mm]	L [mm]	Material	Design	Part No.	PU ¹⁾	US	EU
18	28	10	7	88 NBR 101	AS	12665 40421124	IP SP		● ●
	28	10	7	94 AU 925	AUAS	12666 40421125	IP SP		● ●
	30	9	6	U801	DKI	FD0815-A0	-	○	
20	26	7	4	88 NBR 101	AS	101411 40421835	IP SP	○	● ●
	28	5	3,5	88 NBR 99035	AS	454492 40422005	IP SP		● ●
	28	5	3,5	94 AU 925	AUAS	12668 40421126 126680	IP SP -	○	● ●
	28	6	5	U801	DSI	FQ0014-D0	-	○	
	28	7	4	88 NBR 101	ASOB	86181 40421794	IP SP		● ●
	28	7	4	95 AU V149	PU 5	24314503 40422430	IP SP		● ●
	28	7	4,8	94 AU 925	AUASOB	336667 40421915	IP SP	○	● ●
	28	7,8	5	95 AU V149	PU 5	24312946 40422426	IP SP		● ●
	28,6	6,5	5,3	95 AU V149	PU 6	24004784 40422091	IP SP		● ●
	28,6	7	5,3	85 FKM K664	P 6	24038859	IP		●
	30	6	4	88 NBR 99035	AS	454493 40422006	IP SP		● ●
	30	6	4	94 AU 925	AUAS	32064 40421740	IP SP		● ●
	30	10	7	88 NBR 99035	AS	454498 40422007	IP SP	○	● ●
	30	10	7	94 AU 925	AUAS	12670 40421127	IP SP		● ●
	32	9	6	A795	DKH	AR0995-F5	-	○	
	32	9	6	U801	DKI	FD0995-A0	-	○	
21	28	5,5	3,5	88 NBR 101	AS	24825 40421702	IP SP	○	● ●
22	28	8	5	88 NBR 99035	AS	454499 40422008	IP SP	○	● ●
	30	7	4	88 NBR 101	ASOB	86182 40421795	IP SP		● ●
	30	7	4	95 AU V149	PU 5	24314505 40422431	IP SP		● ●
	30	7	4,8	94 AU 925	AUASOB	336666 40421914	IP SP		● ●
	30	7,8	5	95 AU V149	PU 5	24314506	-		○
	30,6	6,5	5,3	95 AU V149	PU 6	24004788 40422092	IP SP		● ●
	32	10	7	88 NBR 99035	AS	454500 40422009	IP SP		● ●
	32	10	7	94 AU 925	AUAS	12672 40421128	IP SP		● ●
	35	8	5	88 NBR 99035	AS	454520 40422010	IP SP		● ●
22,4	30,4	6	5	U801	DSI	FQ0016-D0	-	○	
	34,4	9	6	A795	DKH	AR1203-G5	-	○	
	34,4	9	6	U801	DKI	FD1203-A0	-	○	
23	31	7	4	88 NBR 101	ASOB	401505	-		○
23,5	31,5	6	5	U801	DSI	FQ0017-D0	-	○	
24	32	7	4	88 NBR 101	ASOB	407321 40421957	IP SP		● ●

d [mm]	D [mm]	H [mm]	L [mm]	Material	Design	Part No.	PU ¹⁾	US	EU	
24	32,6	7	5,3	85 FKM K664	P 6	24138825	-		○	
	35	8	5	88 NBR 101	AS	24832 40421705	IP SP	○	● ●	
25	33	6	5	U801	DSI	FQ0018-D0	-	○		
	33	7	4	88 NBR 101	ASOB	86183 40421796	IP SP		● ●	
	33	7	4	95 AU V149	PU 5	24314507 40422432	IP SP		● ●	
	33	7	4	94 AU 30000	PU 5	49334338	-		○	
	33	7	4,8	94 AU 925	AUASOB	336670 40421917	IP SP		● ●	
	33	7,8	5	95 AU V149	PU 5	24297872 40422409	IP SP		● ●	
	33,6	6,5	5,3	95 AU V149	PU 6	24004792 40422093	IP SP		● ●	
	35	10	7	88 NBR 99035	AS	454521 40422011 45452171	IP SP -	○	● ●	
	35	10	7	94 AU 925	AUAS	24905 40421725	IP SP		● ●	
	35	10	7	94 AU 30000	AUAS	49334378	-		○	
	35	10	7	94 AU 925	AUAS R	49044060 40422532	IP SP		● ●	
	35	10	7	94 AU 30000	AUAS R	49334277	-		○	
	37	6,9	6	U801	DWIR	FD1301-G0	-	○		
	37	9	6	A795	DKH	AR1301-F5	-	○		
	37	9	6	U801	DKI	FD1301-A0	-	○		
26	34	8	5	88 NBR 101	AS	24849 40421708	IP SP		● ●	
	35	10	7	88 NBR 101	AS	37555	-	○	○	
27	39	9	6	U801	DKI	FD1503-A0	-	○		
	36	6	5	U801	DSI	FQ0023-D0	-	○		
	36	7	4	88 NBR 101	ASOB	86184 40421797	IP SP		● ●	
	36	7	4	95 AU V149	PU 5	24314509 40422433	IP SP		● ●	
	36	7	4,8	94 AU 925	AUASOB	351683 40421928	IP SP		● ●	
	36	7,8	5	95 AU V149	PU 5	24294374	-		○	
	36,6	6,5	5,3	95 AU V149	PU 6	24004798 40422094	IP SP		● ●	
	36,6	7	5,3	85 FKM K664	P 6	24032459	IP		●	
	38	8	5	88 NBR 99035	AS	454522 40422012	IP SP		● ●	
	40	9	6	A795	DKH	AR1536-G5	-	○		
	40	9	6	U801	DKI	FD1536-A0	-	○		
	40	10	7	88 NBR 101	AS	33763 40421742	IP SP		● ●	
	40	10	7	94 AU 925	AUAS	12680 40421129	IP SP	○	● ●	
	30	38	6,5	6	U801	DSI	FQ0025-D0	-	○	
		38	7	4	95 AU V149	PU 5	24314511 40422434	IP SP		● ●
38		7	4	94 AU 30000	PU 5	49334339	-		○	
38,6		6,5	5,3	95 AU V149	PU 6	24004799 40422095	IP SP		● ●	
38,6		7	5,3	85 FKM K664	P 6	24040159	IP		●	

d [mm]	D [mm]	H [mm]	L [mm]	Material	Design	Part No.	PU ¹⁾	US	EU	
30	40	8	5	88 NBR 99035	AS	454525 40422013	IP SP		● ●	
	40	8	5	94 AU 925	AUAS	24925 40421734	IP SP		● ●	
	40	10	7	88 NBR 99035	AS	454526 40422014	IP SP		● ●	
	40	10	7	94 AU 925	AUAS	32066 40421741	IP SP		● ●	
	40	10	7	94 AU 30000	AUAS	49334379	-		○	
	40	10	7	94 AU 925	AUAS R	521387 40422037 1449480	IP SP -	●	● ●	
	40	10	7	94 AU 30000	AUAS R	49334278	-		○	
	42	6,9	6	U801	DWIR	FD1664H0	-	○		
	42	9	6	A795	DKH	AR1664-G5	-	○		
	42	9	6	U801	DKI	FD1664-A0	-	○		
	45	8	5	88 NBR 101	AS	24865 40421711	IP SP		● ●	
	45	8	5	94 AU 925	AUAS	12683 40421130 1268330	IP SP -	○	● ●	
	31,5	39,5	6,5	6	U801	DSI	FG0027-D0	-	○	
		44	10	7	U801	DKI	FD1803-A0	-	○	
32	40	7	4	88 NBR 101	ASOB	86185 40421798	IP SP		● ●	
	40	7	4	95 AU V149	PU 5	24314512 40422435	IP SP		● ●	
	40	7	4,8	94 AU 925	AUASOB	336671 40421918	IP SP		● ●	
	40	7,8	5	95 AU V149	PU 5	24288780 40422394	IP SP		● ●	
	40,6	6,5	5,3	95 AU V149	PU 6	24004805 40422096	IP SP		● ●	
	40,6	7	5,3	85 FKM K664	P 6	24050857	IP		●	
	44	10	7	U801	DKI	FD1870-A0	-	○		
	45	8	4	88 NBR 101	AS	24847 40421707	IP SP	○	● ●	
	45	8	4	94 AU 925	AUAS	24904 40421724	IP SP		● ●	
	45	10	7	88 NBR 101	AS	12684 40421131	IP SP		● ●	
	45	10	7	94 AU 925	AUAS	12685 40421132	IP SP		● ●	
35	43	6,5	6	U801	DSI	FG0031-D0	-	○		
	43	7	4	88 NBR 101	ASOB	316832 40421871	IP SP		● ●	
	43	7	4	95 AU V149	PU 5	24314513 40422436	IP SP		● ●	
	43	7	4	94 AU 30000	PU 5	49334340	-		○	
	43,6	6,5	5,3	95 AU V149	PU 6	24004808 40422097	IP SP		● ●	
	43,6	7	5,3	85 FKM K664	P 6	24033859	IP		●	
	45	7	7	94 AU 925	AU PS	522243 40422061	IP SP	○	● ●	
	45	10	7	88 NBR 99035	AS	454527 40422015	IP SP	○	● ●	
	45	10	7	94 AU 925	AUAS	24903 40421723	IP SP	○	● ●	
	45	10	7	94 AU 30000	AUAS	49334450	-		○	

d [mm]	D [mm]	H [mm]	L [mm]	Material	Design	Part No.	PU ¹⁾	US	EU
35	45	10	7	94 AU 925	AUAS R	521935 40422060 1402392	IP SP -	●	●●
	45	10	7	94 AU 30000	AUAS R	49334279	-		○
	47	7,9	7	U801	DWIR	FD2041J0	-	○	
	47	10	7	A795	DKH	AR2041-F5	-	○	
	47	10	7	U801	DKI	FD2041-A0	-	○	
35,5	43,5	6,5	6	U801	DSI	FG0034-D0	-	○	
	47,5	10	7	A795	DKH	AR2149J5	-	○	
	47,5	10	7	U801	DKI	FD2149-A0	-	○	
36	44	7	4	88 NBR 101	ASOB	86186 40421799	IP SP		●●
	44	7	4	95 AU V149	PU 5	24314514 40422437	IP SP		●●
	44	7	4	94 AU 30000	PU 5	49334342	-		○
	44	7	4,8	94 AU 925	AUASOB	395708 40421939	IP SP		●●
	44	7,8	5	95 AU V149	PU 5	24294375 40422405	IP SP		●●
	44,6	6,5	5,3	95 AU V149	PU 6	24004811 40422098	IP SP		●●
	45	10	7	88 NBR 99035	AS	454528 40422016	IP SP		●●
	45	10	7	94 AU 925	AUAS	24935 40421736	IP SP		●●
	45	10	7	94 AU 30000	AUAS	49334451	-		○
	38	48	10	7	88 NBR 99035	AS	464059 40422036	IP SP	
48		10	7	94 AU 925	AUAS	24912 40421730	IP SP		●●
50		10	7	U801	DKI	FD2217-A0	-	○	
40	48	6,5	6	U801	DSI	FG0035-D0	-	○	
	48	7	4	88 NBR 101	ASOB	86187 40421800	IP SP		●●
	48	7	4	95 AU V149	PU 5	24311206 40422420	IP SP		●●
	48	7	4	94 AU 30000	PU 5	49334343	-		○
	48	7	4,8	94 AU 925	AUASOB	336665 40421913	IP SP	○	●●
	48	7,8	5	95 AU V149	PU 5	24291068 40422403	IP SP		●●
	48,6	6,5	5,3	95 AU V149	PU 6	24004816 40422099	IP SP		●●
	50	7	7	94 AU 925	AU PS	522244 40422062	IP SP	○	●●
	50	8	5	88 NBR 99035	AS	454529 40422017	IP SP		●●
	50	8	5	94 AU 925	AUAS	24908 40421727	IP SP		●●
40	50	8	5	94 AU 30000	AUAS	49334452	-		○
	50	10	7	88 NBR 99035	AS	454530 40422018	IP SP	○	●●
	50	10	7	94 AU 925	AUAS	12691 40421133	IP SP		●●
	50	10	7	94 AU 30000	AUAS	49334453	-		○
	50	10	7	94 AU 925	AUAS R	521393 40422038 1449492	IP SP -	●	●●
	50	10	7	94 AU 30000	AUAS R	49334310	-		○
	52	7	7	U801	DWI	FD2342-G0	-	○	

d [mm]	D [mm]	H [mm]	L [mm]	Material	Design	Part No.	PU ¹⁾	US	EU
40	52	8	5	88 NBR 101	AS	38927 40421751	IP SP		● ●
	52	10	7	A795	DKH	AR2342-F5	-	○	
	52	10	7	U801	DKI	FD2342-A0	-	○	
	52	10	7	U801	DWIR	FD2342-H0	-	○	
42	50	7	4	88 NBR 101	ASOB	401512 40421950	IP SP	○	● ●
	50,6	6,5	5,3	95 AU V149	PU 6	24004820 40422100	IP SP		● ●
	50,6	7	5,3	85 FKM K664	P 6	24044057	-		○
	52	10	7	88 NBR 101	AS	24874 40421713	IP SP	○	● ●
	52	10	7	94 AU 925	AUAS	24922 40421732	IP SP	○	● ●
53	6,5	6	U801	DSI	FG0039-D0	-	○		
53	7	4	88 NBR 101	ASOB	86188 40421801	IP SP		● ●	
53	7	4	95 AU V149	PU 5	24310500 40422419	IP SP		● ●	
53	7	4	94 AU 30000	PU 5	49334344	-		○	
53	7	4,8	94 AU 925	AUASOB	336663 40421912	IP SP		● ●	
53	7,8	5	95 AU V149	PU 5	24288781 40422395	IP SP		● ●	
53,5	8	5	88 NBR 99035	AS	454532	-		○	
53,6	6,5	5,3	95 AU V149	PU 6	24375906 40422506	IP SP		● ●	
53,6	7	5,3	85 FKM K664	P 6	24040959	-		○	
45	55	7	7	94 AU 925	AU PS	522248 40422063	IP SP	○	● ●
	55	10	7	88 NBR 99035	AS	454557 40422019	IP SP		● ●
	55	10	7	94 AU 925	AUAS	4104 40421003 1410713	IP SP -	●	● ●
	55	10	7	94 AU 30000	AUAS	49334454	-		○
	55	10	7	94 AU 925	AUAS R	521400 40422039	IP SP		● ●
	55	10	7	94 AU 30000	AUAS R	49334312	-		○
	55,6	6,5	5,3	95 AU V149	PU 6	24004827 40422101	IP SP		● ●
	55,6	7	5,3	85 FKM K664	P 6	24056947	IP		●
	57	7	7	U801	DWI	FD2633-H0	-	○	
	57	10	7	A795	DKH	AR2633-I5	-	○	
57	10	7	U801	DKI	FD2633-A0	-	○		
57	10	7	U801	DWIR	FD2633-J0	-	○		
60	10	7	88 NBR 99035	AS	454560 40422020	IP SP		● ●	
60	10	7	94 AU 925	AUAS	24888 40421715	IP SP		● ●	
45,5	53,5	6,5	6	U801	DSI	FG0864-D0	-	○	
47	59	10	7	U801	DKI	FD2729-A0	-	○	
48	56	7	4	88 NBR 101	ASOB	401567	-		○
	60	10	7	88 NBR 101	AS	12696 40421134	IP SP	○	● ●
	60	10	7	94 AU 925	AUAS	12697 40421135	IP SP		● ●
50	56	7	5	88 NBR 99035	AS	454564 40422021	IP SP		● ●

d [mm]	D [mm]	H [mm]	L [mm]	Material	Design	Part No.	PU ¹⁾	US	EU
	56	7	5	94 AU 925	AUAS	24889 40421716	IP SP		● ●
	58	6,5	6	U801	DSI	FG0041-D0	-	○	
	58	7	4	88 NBR 101	ASOB	86189 40421802	IP SP		● ●
	58	7	4	95 AU V149	PU 5	24311362 40422421	IP SP		● ●
	58	7	4	94 AU 30000	PU 5	49334345	-		○
	58	7	4,8	94 AU 925	AUASOB	49062224	IP		●
	58	7,8	5	95 AU V149	PU 5	24275192 40422391	IP SP		● ●
	58,6	6,5	5,3	95 AU V149	PU 6	24375907 40422507	IP SP		● ●
	58,6	7	5,3	85 FKM K664	P 6	24036259	IP		●
	60	7	7	94 AU 925	AU PS	522249 40422064	IP SP	○	● ●
50	60	10	7	88 NBR 99035	AS	454565 40422022	IP SP	○	● ●
	60	10	7	94 AU 925	AUAS	24927 40421735	IP SP		● ●
	60	10	7	94 AU 30000	AUAS	49334455	-		○
	60	10	7	94 AU 925	AUAS R	521404 40422040	IP SP		● ●
	60	10	7	94 AU 30000	AUAS R	49334313	-		○
	60,6	6,5	5,3	95 AU V149	PU 6	24004835 40422102	IP SP		● ●
	62	7	7	U801	DWI	FD2831-F0	-	○	
	62	10	7	A795	DKH	AR2831-H5	-	○	
	62	10	7	U801	DKI	FD2831-A0	-	○	
	65	10	7	88 NBR 99035	AS	454566 40422023	IP SP		● ●
	70	10	7	88 NBR 101	AS	39497 40421752	IP SP		● ●
52	62	10	7	88 NBR 101	AS	12700 40421137	IP SP		● ●
	62	10	7	94 AU 925	AUAS	12699 40421136	IP SP	○	● ●
53	61	6,5	6	U801	DSI	FG0044-D0	-	○	
	67	11	8	U801	DKI	FD2985-A0	-	○	
54	62	7	4	88 NBR 101	ASOB	401571 40421951	IP SP		● ●
54,5	62,5	6,5	6	U801	DSI	FG0857-D0	-	○	
	63	6,5	6	U801	DSI	FG0045-D0	-	○	
	63	7	4	88 NBR 101	ASOB	407332 40421959	IP SP		● ●
	63	7	4	95 AU V149	PU 5	24311363 40422422	IP SP		● ●
	63	7	4	94 AU 30000	PU 5	49334346	-		○
	63	10	7	88 NBR 99035	AS	454567 40422024	IP SP		● ●
55	63	10	7	94 AU 925	AUAS	24923 40421733	IP SP		● ●
	63	10	7	94 AU 30000	AUAS	49334456	-		○
	65	10	7	88 NBR 99035	AS	454573 40422025	IP SP		● ●
	65	10	7	94 AU 925	AUAS R	530779 40422084	IP SP		● ●
	65	10	7	94 AU 30000	AUAS R	49334314	-		○
	65,6	7	5,3	85 FKM K664	P 6	24049905	IP		●

d [mm]	D [mm]	H [mm]	L [mm]	Material	Design	Part No.	PU ¹⁾	US	EU
55	65,6	7	5,3	95 AU V149	PU 6	24004846 40422103	IP SP		● ●
	69	8	8	U801	DWI	FD3033-F0	-	○	
	69	11	8	A795	DKH	AR3033-G5	-	○	
	69	11	8	U801	DKI	FD3033-A0	-	○	
	69	11,3	8	U801	DWIR	FD3033-I0	-	○	
56	64	6,5	6	U801	DSI	FQ0048-D0	-	○	
	64	7	4	88 NBR 101	ASOB	86190 40421803	IP SP		● ●
	64	7	4	95 AU V149	PU 5	24314518 40422438	IP SP		● ●
	64,6	6,5	5,3	95 AU V149	PU 6	24375908	-		○
	66	8,3	6,1	94 AU 925	AUASOB	351685	-		○
	66	9	6,3	95 AU V149	PU 5	24289916 40422399	IP SP		● ●
	66	10	7	88 NBR 101	AS	6259 40421005	IP SP	○	● ●
	66,6	7	5,3	85 FKM K664	P 6	24049005	IP		●
	66,6	7	5,3	95 AU V149	PU 6	24004849 40422104	IP SP		● ●
	70	11	8	U801	DKI	FD3089-A0	-	○	
60	68	6,5	6	U801	DSI	FQ0049-D0	-	○	
	68	7	4	88 NBR 101	ASOB	8626 40421006	IP SP		● ●
	68	7	4	95 AU V149	PU 5	24311364 40422423 8056-311.364	IP SP -	○	● ●
	68	7	4	94 AU 30000	PU 5	49334347	-		○
	68,6	6,5	5,3	95 AU V149	PU 6	24375909	-		○
	70	9	6,3	95 AU V149	PU 5	24275194	-		○
	70	10	7	88 NBR 99035	AS	454574 40422026	IP SP	○	● ●
	70	10	7	94 AU 925	AUAS	12708 40421138	IP SP		● ●
	70	10	7	94 AU 30000	AUAS	49334457	-		○
	70	10	7	94 AU 925	AUAS R	521431 40422041	IP SP	○	● ●
	70	10	7	94 AU 30000	AUAS R	49334315	-		○
	70,6	7	5,3	85 FKM K664	P 6	24038207	IP		●
	70,6	7	5,3	95 AU V149	PU 6	24004853 40422105	IP SP		● ●
	72	10	5,5	95 AU V149	PU 5	24368032	-		○
	74	8	5	88 NBR 101	AS	24811 40421695 2481100	IP SP -	○	● ●
74	8	5	94 AU 925	AUAS	24890 40421717	IP SP		● ●	
74	8	8	U801	DWI	FD3187-H0	-	○		
74	11	8	A795	DKH	AR3187-J5	-	○		
74	11	8	U801	DKI	FD3187-A0	-	○		
74	11,3	8	U801	DWIR	FD3187-G0	-	○		
75	13	8,2	85 NBR B247	P 6	24004856	-		○	
78	15	11	88 NBR 101	AS	24828 40421703	IP SP		● ●	
80	10	7	88 NBR 101	AS	45 40421000	IP SP		● ●	
61	74	8	8	U801	DWI	FD6782-E0	-	○	

d [mm]	D [mm]	H [mm]	L [mm]	Material	Design	Part No.	PU ¹⁾	US	EU	
62	70	6,5	6	U801	DSI	FG0856-D0	-	○		
63	71	6,5	6	U801	DSI	FG0054-D0	-	○		
	71	7	4	88 NBR 101	ASOB	86194 40421804	IP SP		● ●	
	71	7	4	95 AU V149	PU 5	24311365 40422424	IP SP		● ●	
	71	7	4	94 AU 30000	PU 5	49334348	-		○	
	73	8,3	6,1	94 AU 925	AUASOB	336662	-		○	
	73	8,3	6,1	94 AU 925	AUASOB	49061215	IP		●	
	73	9	6,3	95 AU V149	PU 5	24275195 40422392	IP SP		● ●	
	73,6	7	5,3	85 FKM K664	P 6	24040605	-		○	
	73,6	7	5,3	95 AU V149	PU 6	24004859 40422106	IP SP		● ●	
	75	10	7	88 NBR 101	AS	36267 40421749	IP SP		● ●	
	75	10	7	94 AU 925	AUAS	15939 40421336 371497	IP SP -		○	● ●
	75	10	7	94 AU 30000	AUAS	49334458	-		○	
	77	8	8	U801	DWI	FD3313-E0	-		○	
	77	11	8	U801	DKI	FD3313-A0	-		○	
64	78	11	8	U801	DKI	FD3366-A0	-	○		
65	73	6,5	6	U801	DSI	FG0057-D0	-	○		
	73	7	4	88 NBR 101	ASOB	385492 40421938	IP SP	○	● ●	
	73	7	4	95 AU V149	PU 5	24314521 40422439	IP SP		● ●	
	73	7	4	94 AU 30000	PU 5	49334349	-		○	
	75	10	7	88 NBR 99035	AS	454620 40422034 45462072	IP SP -		○	● ●
	75	10	7	94 AU 925	AUAS	24902 40421722 146-0741	IP SP -		○	● ●
	75	10	7	94 AU 30000	AUAS	49334459	-		○	
	75	10	7	94 AU 925	AUAS R	530783 40422085	IP SP		● ●	
	75	10	7	94 AU 30000	AUAS R	49334316	-		○	
	75,6	7	5,3	85 FKM K664	P 6	24040105	IP		●	
	75,6	7	5,3	95 AU V149	PU 6	24004869 40422107	IP SP		● ●	
	79	8	8	U801	DWI	FD3381-I0	-		○	
	79	11	8	A795	DKH	AR3381-G5	-		○	
	79	11	8	U801	DKI	FD3381-A0	-		○	
79	11,3	8	U801	DWIR	FD3381-G0	-		○		
67	75	6,5	6	U801	DSI	FG0058-D0	-	○		
	81	11	8	U801	DKI	FD3447-A0	-	○		
68	76	7	4	88 NBR 101	ASOB	401579	-		○	
70	78	7	4	88 NBR 101	ASOB	86195 40421805	IP SP		● ●	
	78	7	4	95 AU V149	PU 5	24314522 40422440	IP SP		● ●	
	78	7	4	94 AU 30000	PU 5	49334350	-		○	
	78,6	6,5	5,3	95 AU V149	PU 6	24375910	-		○	
	78,6	7	5,3	85 FKM K664	P 6	24147620	-		○	

d [mm]	D [mm]	H [mm]	L [mm]	Material	Design	Part No.	PU ¹⁾	US	EU
70	80	6,1	8,3	94 AU 925	AUASOB	351686 40421929	IP SP		● ●
	80	7	7	94 AU 925	AU PS	522250 40422065	IP SP	○	● ●
	80	8	7	U801	DSI	FG0059-D0	-	○	
	80	9	6,3	95 AU V149	PU 5	24288253 40422393	IP SP		● ●
	80	9	6,3	94 AU 30000	PU 5	49334351	-		○
	80	10	7	88 NBR 99035	AS	454575 40422027	IP SP		● ●
	80	10	7	94 AU 925	AUAS	24901 40421721	IP SP		● ●
	80	10	7	94 AU 30000	AUAS	49334460	-		○
	80	10	7	94 AU 925	AUAS R	521502 40422043	IP SP		● ●
	80	10	7	94 AU 30000	AUAS R	49334317	-		○
	80,6	7	5,3	85 FKM K664	P 6	24046105	IP		●
	80,6	7	5,3	95 AU V149	PU 6	24004881 40422108	IP SP		● ●
	82	10	5,5	95 AU V149	PU 5	24368033	-		○
	84	8	8	U801	DWI	FD3493-I0	-	○	
	84	11	8	U801	DKI	FD3493-A0	-	○	
	84	11,3	8	U801	DWIR	FD3493-K0	-	○	
71	81	8	7	U801	DSI	FG0062-D0	-	○	
	85	11	8	U801	DKI	FD3546-A0	-	○	
75	83	7	4	88 NBR 101	ASOB	407323 40421958	IP SP		● ●
	83	7	4	95 AU V149	PU 5	24314523 40422441	IP SP		● ●
	83	7	4	94 AU 30000	PU 5	49334352	-		○
	83	10	7	88 NBR 101	AS	12713	-		○
	83	10	7	94 AU 925	AUAS	33555	-		○
	85	8	7	U801	DSI	FG0063-D0	-	○	
	85	10	7	88 NBR 99035	AS	454576 40422028	IP SP		● ●
	85	10	7	94 AU 925	AUAS	24909 40421728	IP SP		● ●
	85	10	7	94 AU 30000	AUAS	49334461	-		○
	87,2	12	7,2	85 FKM K664	P 6	24043206	IP		●
	87,2	12	7,2	95 AU V149	PU 6	24004892 40422109	IP SP		● ●
	89	8	8	U801	DWI	FD3596-F0	-	○	
89	11	8	U801	DKI	FD3596-A0	-	○		
89	11,3	8	U801	DWIR	FD3596-I0	-	○		
76	86	8	7	U801	DSI	FG0250-D0	-	○	
80	88	7	4	88 NBR 101	ASOB	86196 40421806	IP SP		● ●
	88	7	4	95 AU V149	PU 5	24314524 40422442	IP SP		● ●
	88	7	4	94 AU 30000	PU 5	49334353	-		○
	88,6	7	5,3	85 FKM K664	P 6	24044959	IP		●
	90	6,1	8,3	94 AU 925	AUASOB	49061216	IP		●
	90	7	7	94 AU 925	AU PS	522251 40422066	IP SP	●	● ●
	90	8	7	U801	DSI	FG0064-D0	-	○	
	90	9	6,3	95 AU V149	PU 5	24288782 40422396	IP SP		● ●

d [mm]	D [mm]	H [mm]	L [mm]	Material	Design	Part No.	PU ¹⁾	US	EU
	90	9	6,3	94 AU 30000	PU 5	49334354	-		○
	90	10	7	88 NBR 99035	AS	454577 40422029	IP SP	○	● ●
	90	10	7	94 AU 925	AUAS	24907 40421726	IP SP		● ●
	90	10	7	94 AU 30000	AUAS	49334462	-		○
	90	10	7	94 AU 925	AUAS R	521506 40422044	IP SP		● ●
	90	10	7	94 AU 30000	AUAS R	49334318	-		○
80	92	10	5,5	95 AU V149	PU 5	24368034	IP		●
	92,2	12	7,2	85 FKM K664	P 6	24032405	IP		●
	92,2	12	7,2	95 AU V149	PU 6	24004909 40422110	IP SP		● ●
	94	8	8	U801	DWI	FD3720-G0	-	○	
	94	11	8	A795	DKH	AR3720-H5	-	○	
	94	11	8	U801	DKI	FD3720-A0	-	○	
	94	11,3	8	U801	DWIR	FD3720-K0	-	○	
	100	15	12	88 NBR 101	AS	24845 40421706	IP SP		● ●
	93	7	4	88 NBR 101	ASOB	401582	-		○
	93	7	4	95 AU V149	PU 5	24314525 40422443	IP SP		● ●
	93	7	4	94 AU 30000	PU 5	49334355	-		○
	95	8	7	U801	DSI	FQ0066-D0	-	○	
	95	9	6,3	95 AU V149	PU 5	49005211 40422522	IP SP		● ●
	95	10	7	88 NBR 101	AS	24813 40421696	IP SP	○	● ●
85	95	10	7	94 AU 925	AUAS	12718 40421139	IP SP		● ●
	95	10	7	94 AU 30000	AUAS	49334463	-		○
	97,2	12	7,2	85 FKM K664	P 6	24031805	IP		●
	97,2	12	7,2	95 AU V149	PU 6	24004917 40422111	IP SP		● ●
	99	8	8	U801	DWI	FD3828-H0	-	○	
	99	11	8	A795	DKH	AR3828-G5	-	○	
	99	11	8	U801	DKI	FD3828-A0	-	○	
	99	11,3	8	U801	DWIR	FD3828-M0	-	○	
	98	7	4	88 NBR 101	ASOB	86197 40421807	IP SP	○	● ●
	98	7	4	95 AU V149	PU 5	24314526 40422444	IP SP		● ●
	98	7	4	94 AU 30000	PU 5	49334356	-		○
	100	7	7	94 AU 925	AU PS	49003160 40422520	IP SP		● ●
	100	8	7	U801	DSI	FQ0070-D0	-	○	
90	100	9	6,3	95 AU V149	PU 5	24275179 40422389 8056-275.179	IP SP -	○	● ●
	100	10	7	88 NBR 99035	AS	454578 40422030	IP SP		● ●
	100	10	7	94 AU 925	AUAS	24893 40421718	IP SP		● ●
	100	10	7	94 AU 30000	AUAS	49334464	-		○
	102	10	5,5	95 AU V149	PU 5	24368035	IP		●
	102,2	12	7,2	85 FKM K664	P 6	24033905	IP		●

d [mm]	D [mm]	H [mm]	L [mm]	Material	Design	Part No.	PU ¹⁾	US	EU
90	102,2	12	7,2	95 AU V149	PU 6	24004928 40422112	IP SP		● ●
	104	8	8	U801	DWI	FD3913-F0	-	○	
	104	11	8	A795	DKH	AR3913-F5	-	○	
	104	11	8	U801	DKI	FD3913-A0	-	○	
	104	11,3	8	U801	DWIR	FD3913-G0	-	○	
92	106	11	8	U801	DKI	FD3957-A0	-	○	
95	105	8	7	U801	DSI	FG0071-D0	-	○	
	105	10	7	88 NBR 99035	AS	454579 40422031	IP SP		● ●
	105	10	7	94 AU 925	AUAS	24894 40421719	IP SP	○	● ●
	105	10	7	94 AU 30000	AUAS	49334465	-		○
	109	8	8	U801	DWI	FD3976-L0	-	○	
	109	11	8	A795	DKH	AR3976-H5	-	○	
	109	11	8	U801	DKI	FD3976-A0	-	○	
97	109	11,3	8	U801	DWIR	FD3976-K0	-	○	
	107	8	7	U801	DSI	FG0251-D0	-	○	
100	108	7	4	88 NBR 101	ASOB	86198 40421808	IP SP		● ●
	108	7	4	95 AU V149	PU 5	24314527 40422445	IP SP		● ●
	108	7	4	94 AU 30000	PU 5	49334357	-		○
	108,6	7,1	5,3	85 FKM K664	P 6	24051358	-		○
	110	8	7	U801	DSI	FG0072-D0	-	○	
	110	10	7	88 NBR 99035	AS	454580 40422032	IP SP	○	● ●
	110	10	7	94 AU 925	AUAS	24895 40421720	IP SP	○	● ●
	110	10	7	94 AU 30000	AUAS	49334466	-		○
	112,2	12	7,2	85 FKM K664	P 6	24031905	IP		●
	112,2	12	7,2	95 AU V149	PU 6	24004944 40422113	IP SP		● ●
	114	8	8	U801	DWI	FD4046-F0	-	○	
	114	11	8	A795	DKH	AR4046-E5	-	○	
	114	11	8	U801	DKI	FD4046-A0	-	○	
	114	11,3	8	U801	DWIR	FD4046-G0	-	○	
	115	9	9	94 AU 925	AU PS	49308467	-		○
	115	10	8	94 AU 925	AUAS	103750 40421836	IP SP		● ●
	115	12,3	9,3	94 AU 925	AUASOB	336660 40421911	IP SP	○	● ●
105	115	13	9,5	95 AU V149	PU 5	24275180 40422390	IP SP		● ●
	115	8	7	U801	DSI	FG0075-D0	-	○	
	115	10	7	88 NBR 101	AS	24816 40421697	IP SP		● ●
	115	10	7	94 AU 925	AUAS	12721 40421140	IP SP		● ●
	115	10	7	94 AU 30000	AUAS	49334467	-		○
	117,2	12	7,2	85 FKM K664	P 6	24046106	-		○
	117,2	12	7,2	95 AU V142	PU 6	24004956	IP		●
	121	9	9	U801	DWI	FD4142-I0	-	○	
	121	12	9	A795	DKH	AR4142-E5	-	○	
	121	12	9	U801	DKI	FD4142-A0	-	○	

d [mm]	D [mm]	H [mm]	L [mm]	Material	Design	Part No.	PU ¹⁾	US	EU
105	121	12,3	9	U801	DWIR	FD4142-H0	-	○	
106	116	8	7	U801	DSI	FG0078-D0	-	○	
	122	12	9	U801	DKI	FD4168-A0	-	○	
108	125	12	9	U801	DKI	FD4187-E0	-	○	
110	120	8	7	U801	DSI	FG0079-D0	-	○	
	120	10	7	88 NBR 99035	AS	454582 40422033	IP SP	○	● ●
	120	10	7	94 AU 925	AUAS	103752 40421837	IP SP		● ●
	120	10	7	94 AU 30000	AUAS	49334468	-		○
	122	10	5,5	88 NBR 101	ASOB	86199 40421809	IP SP		● ●
	122	10	5,5	95 AU V149	PU 5	24314528 40422446	IP SP		● ●
	122	10	5,5	94 AU 30000	PU 5	49334358	-		○
	122,2	12	7,2	85 FKM K664	P 6	24042306	IP		●
	122,2	12	7,2	95 AU V149	PU 6	24004961 40422114	IP SP		● ●
	125	8	8	94 AU 925	AU PS	49061696	IP		●
	125	12,3	9,3	94 AU 925	AUASOB	49065833	IP		●
	125	12,3	9,3	94 AU 925	AUASOB	351690 40421930	IP SP		● ●
	125	13	9,5	95 AU V149	PU 5	24265869 40422377	IP SP		● ●
	126	9	9	U801	DWVI	FD4196-F0	-	○	
	126	12	9	U801	DKI	FD4196-A0	-	○	
126	12,3	9	U801	DWIR	FD4196-G0	-	○		
112	122	8	7	U801	DSI	FG0082-D0	-	○	
	128	12	9	U801	DKI	FD4232-A0	-	○	
115	125	10	7	88 NBR 101	AS	24817 40421698	IP SP		● ●
	125	10	7	94 AU 925	AUAS	103753 40421838	IP SP		● ●
	125	10	7	94 AU 30000	AUAS	49334469	-		○
	127	10	5,5	88 NBR 101	ASOB	401585	-		○
	127	10	5,5	95 AU V149	PU 5	24314529	-		○
	127,2	12	7,2	85 FKM K664	P 6	24041405	-		○
	127,2	12	7,2	95 AU V149	PU 6	24004968 40422115	IP SP		● ●
131	12	9	U801	DKI	FD4272-E0	-	○		
118	128	8	7	U801	DSI	FG0085-D0	-	○	
	134	12	9	U801	DKI	FD4317-A0	-	○	
120	130	8	7	U801	DSI	FG0087-D0	-	○	
	130	10	7	90 NBR 109	AS	24819 40421699	IP SP		● ●
	130	10	7	94 AU 925	AUAS	103754 40421839	IP SP		● ●
	130	10	7	94 AU 30000	AUAS	49334470	-		○
	130,6	7	5,3	85 FKM K664	P 6	24050006	-		○
	132	10	5,5	95 AU V149	PU 5	24314530 40422447	IP SP		● ●
	132	10	5,5	94 AU 30000	PU 5	49334359	-		○
	132,2	12	7,2	85 FKM K664	P 6	24047507	-		○
	132,2	12	7,2	95 AU V149	PU 6	24004975 40422116	IP SP		● ●
136	9	9	U801	DWVI	FD4326-F0	-	○		



d [mm]	D [mm]	H [mm]	L [mm]	Material	Design	Part No.	PU ¹⁾	US	EU
120	136	12	9	A795	DKH	AR4326-H5	-	○	
	136	12	9	U801	DKI	FD4326-A0	-	○	
	136	12,3	9	U801	DWIR	FD4326-G0	-	○	
125	137	10	5,5	88 NBR 101	ASOB	86200 40421810	IP SP		● ●
	137	10	5,5	95 AU V149	PU 5	24314531 40422448	IP SP		● ●
	138	9,5	8	U801	DSI	FG0091-D0	-	○	
	140	12	9	88 NBR 101	AS	24831 40421704	IP SP	○	● ●
	140	12	9	94 AU 925	AUAS	103755 40421840	IP SP	○	● ●
	140	12	9	94 AU 30000	AUAS	49334471	-		○
	140	12,3	9,3	94 AU 925	AUASOB	336659 40421910	IP SP		● ●
	140	13	9,5	95 AU V149	PU 5	24289918 40422400	IP SP		● ●
	140	13	9,5	94 AU 30000	PU 5	49334360	-		○
	140	16	10,2	95 AU V149	PU 6	24004981 40422117	IP SP		● ●
	141	12	9	U801	DKI	FD4393-A0	-	○	
130	142	10	5,5	95 AU V149	PU 5	24314532	-		○
	143	9,5	8	U801	DSI	FG0093-D0	-	○	
	145	12	9	88 NBR 101	AS	24872 40421712	IP SP		● ●
	145	12	9	94 AU 925	AUAS	103756 40421841	IP SP		● ●
	145	12	9	94 AU 30000	AUAS	49334472	-		○
	146	9	9	U801	DWI	FD4438-G0	-	○	
	146	12	9	A795	DKH	AR4438-E5	-	○	
	146	12	9	U801	DKI	FD4438-A0	-	○	
132	146	12,3	9	U801	DWIR	FD4438-H0	-	○	
	145	9,5	8	U801	DSI	FG0095-D0	-	○	
135	148	12	9	U801	DKI	FD4476-A0	-	○	
	145	10	7	88 NBR 101	AS	15034 40421291	IP SP		● ●
	150	12	9	94 AU 925	AUAS	103757 40421842	IP SP		● ●
	150	12	9	94 AU 30000	AUAS	49334473	-		○
	150	13	9,5	95 AU V149	PU 5	49072239	IP		●
140	155	14	10	U801	DKI	FD4492-A0	-	○	
	152	10	5,5	88 NBR 101	ASOB	401586	-		○
	152	10	5,5	95 AU V149	PU 5	24314534 40422449	IP SP		● ●
	152	10	5,5	94 AU 30000	PU 5	49334361	-		○
	153	9,5	8	U801	DSI	FG0097-D0	-	○	
	155	12	9	88 NBR 101	AS	24855 40421709	IP SP	○	● ●
	155	12	9	94 AU 925	AUAS	103758 40421843	IP SP		● ●
	155	12	9	94 AU 30000	AUAS	49334474	-		○
	155	12,3	9,3	94 AU 925	AUASOB	351693	-		○
	155	13	9,5	95 AU V149	PU 5	24289919 40422401	IP SP		● ●
	155	13	9,5	94 AU 30000	PU 5	49334362	-		○
155	16	10,2	85 FKM K664	P 6	24043305	IP		●	

d [mm]	D [mm]	H [mm]	L [mm]	Material	Design	Part No.	PU ¹⁾	US	EU
140	155	16	10,2	95 AU V149	PU 6	24005002 40422118	IP SP		● ●
	160	10	10	U801	DWI	FD4533-G0	-	○	
	160	12,3	9	U801	DWIR	FD4533-H0	-	○	
	160	14	10	U801	DKI	FD4533-A0	-	○	
145	158	9,5	8	U801	DSI	FG0099-D0	-	○	
	160	12	9	88 NBR 101	AS	26971 40421737	IP SP		● ●
	165	14	10	U801	DKI	FD4578-A0	-	○	
150	162	10	5,5	95 AU V149	PU 5	24314535 40422450	IP SP		● ●
	162	10	5,5	94 AU 30000	PU 5	49334363	-		○
	162,2	12	7,2	95 AU V142	PU 6	24368329	-		○
	163	9,5	8	U801	DSI	FG0101-D0	-	○	
	165	12	9	88 NBR 101	AS	24862 40421710 2486285	IP SP -	○	● ●
	165	12	9	94 AU 925	AUAS	103759 40421844	IP SP		● ●
	165	12	9	94 AU 30000	AUAS	49334476	-		○
	165	16	10,2	85 FKM K664	P 6	24048705	IP		●
	165	16	10,2	95 AU V149	PU 6	24005013 40422119	IP SP		● ●
	170	14	10	U801	DKI	FD4615-A0	-	○	
155	168	9,5	8	U801	DSI	FG0103-D0	-	○	
	170	12,3	9,3	94 AU 925	AUASOB	49013135	-		○
	175	14	10	A795	DKH	AR4663-F5	-	○	
	175	14	10	U801	DKI	FD4663-E0	-	○	
160	172	10	5,5	95 AU V149	PU 5	24314536 40422451	IP SP		● ●
	172	10	5,5	94 AU 30000	PU 5	49334364	-		○
	173	9,5	8	U801	DSI	FG0105-D0	-	○	
	175	12	9	88 NBR 101	AS	24876 40421714	IP SP	○	● ●
	175	12	9	94 AU 925	AUAS	103760 40421845	IP SP		● ●
	175	12	9	94 AU 30000	AUAS	49334477	-		○
	175	12,3	9,3	94 AU 925	AUASOB	336658	-		○
	175	13	9,5	95 AU V149	PU 5	24289920 40422402	IP SP		● ●
	175	16	10,2	85 FKM K664	P 6	24030705	IP		●
	175	16	10,2	95 AU V149	PU 6	24005025 40422120	IP SP		● ●
165	180	14	10	U801	DKI	FD4704-A0	-	○	
	185	14	10	U801	DKI	FD4733-A0	-	○	
170	182	10	5,5	95 AU V149	PU 5	24314538	-		○
	183	9,5	8	U801	DSI	FG0106-D0	-	○	
	185	14	10	88 NBR 101	AS	24822 40421700	IP SP		● ●
	190	14	10	U801	DKI	FD4785-A0	-	○	
175	188	9,5	8	U801	DSI	FG0108-D0	-	○	
	195	14	10	U801	DKI	FD4839-A0	-	○	
180	192	10	5,5	95 AU V149	PU 5	24314539 40422452	IP SP		● ●
	192	10	5,5	94 AU 30000	PU 5	49334365	-		○
	193	9,5	8	U801	DSI	FG0111-D0	-	○	

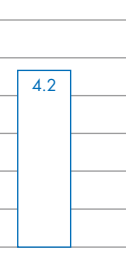

d [mm]	D [mm]	H [mm]	L [mm]	Material	Design	Part No.	PU ¹⁾	US	EU
	195	12,3	9,3	94 AU 925	AUASOB	336657	-		○
	195	13	9,5	95 AU V149	PU 5	24294376	-		○
	195	14	10	88 NBR 101	AS	24823 40421701	IP SP		● ●
180	195	14	10	94 AU 925	AUAS	103761 40421846	IP SP		● ●
	195	14	10	94 AU 30000	AUAS	49334478	-		○
	200	18	10,2	85 FKM K664	P 6	24072417	IP		●
	200	18	10,2	95 AU V149	PU 6	24005039 40422121	IP SP		● ●
	205	17	12	U801	DKI	FD4890-A0	-	○	
185	198	9,5	8	U801	DSI	FG0114-D0	-	○	
	210	17	12	U801	DKI	FD4941-E0	-	○	
	202	12	9	88 NBR 101	AS	12741	-		○
	203	9,5	8	U801	DSI	FG0115-D0	-	○	
190	210	18	10,2	85 FKM K664	P 6	24059854	-		○
	210	18	10,2	95 AU V149	PU 6	24005044 40422122	IP SP		● ●
	215	17	12	U801	DKI	FD4969-A0	-	○	
	220	12	9	88 NBR 101	AS	12742	-		○
199	212	9,5	8	U801	DSI	FG0116-D0	-	○	
	212	10	5,5	95 AU V149	PU 5	24314541 40422453	IP SP		● ●
	213	9,5	8	U801	DSI	FG0117-D0	-	○	
	215	12,3	9,3	94 AU 925	AUASOB	336672	-		○
	215	13	9,5	95 AU V149	PU 5	24294377 40422406	IP SP		● ●
	215	13	9,5	94 AU 30000	PU 5	49334366	-		○
200	220	16	12	88 NBR 101	AS	36009 40421748 36009F	IP SP -	○	● ●
	220	16	12	94 AU 925	AUAS	103763 40421847	IP SP		● ●
	220	16	12	94 AU 30000	AUAS	49334479	-		○
	220	18	10,2	85 FKM K664	P 6	24031705	IP		●
	220	18	10,2	95 AU V149	PU 6	24005050 40422123	IP SP		● ●
	225	17	12	U801	DKI	FD5048-A0	-	○	
204	217	9,5	8	U801	DSI	FG0119-D0	-	○	
205	220	16	7,7	85 NBR B247	P 6	24231362	-		○
	223	9,5	8	U801	DSI	FG0120-D0	-	○	
	225	16	10,2	85 FKM K664	P 6	24293787	-		○
210	230	16	12	88 NBR 101	AS	5312	-		○
	235	17	12	A795	DKH	AR5129-E5	-	○	
	235	17	12	U801	DKI	FD5129-E0	-	○	
212	237	17	12	U801	DKI	FD5151-A0	-	○	
215	228	9,5	8	U801	DSI	FG0408-D1	-	○	
	233	9,5	8	U801	DSI	FG0123-D0	-	○	
	235	16	10,2	85 NBR B203	P 6	24005062	-		○
220	240	16	12	88 NBR 101	AS	19574 40421601	IP SP		● ●
	240	18	10,2	85 NBR B247	P 6	24005063	IP		●
	240	18	10,2	85 FKM K664	P 6	24066033	-		○
	245	17	12	U801	DKI	FD5200-A0	-	○	

d [mm]	D [mm]	H [mm]	L [mm]	Material	Design	Part No.	PU ¹⁾	US	EU
224	237	9,5	8	U801	DSI	FG0124-D0	-	○	
	249	17	12	U801	DKI	FD5237-A0	-	○	
225	238	9,5	8	U801	DSI	FG0125-D0	-	○	
	245	18	10,2	85 NBR B247	P 6	24005067	-		○
	250	17	12	U801	DKI	FD5245-F0	-	○	
230	243	9,5	8	U801	DSI	FG0127-D0	-	○	
	245	16	10,2	85 NBR B247	P 6	24005068	-		○
	250	18	10,2	85 NBR B247	P 6	24005069	-		○
	250	18	10,2	85 FKM K664	P 6	24089283	-		○
	255	17	12	A795	DKH	AR5277-E5	-	○	
	255	17	12	U801	DKI	FD5277-A0	-	○	
236	261	17	12	U801	DKI	FD5326-A0	-	○	
	253	9,5	8	U801	DSI	FG0129-D0	-	○	
240	260	16	12	88 NBR 101	AS	26972 40421738	IP SP	○	●
	260	18	10,2	85 NBR B247	P 6	24005075	IP		●
	260	18	10,2	85 FKM K664	P 6	24143309	IP		●
	265	17	12	A795	DKH	AR5336-E5	-	○	
	265	17	12	U801	DKI	FD5336-A0	-	○	
	245	270	17	12	U801	DKI	FD5379-E0	-	○
250	263	9,5	8	U801	DSI	FG0130-D0	-	○	
	270	18	10,2	85 NBR B247	P 6	24005077	IP		●
	270	18	10,2	85 FKM K664	P 6	24064910	IP		●
	275	17	12	U801	DKI	FD5396-A0	-	○	
260	275	12	10	U801	DSI	FG0134-D0	-	○	
	280	18	10,2	85 NBR B247	P 6	24005083	IP		●
	285	17	12	U801	DKI	FD5451-E0	-	○	
	290	16	12	88 NBR 101	AS	26975	-		○
265	280	16	10,2	85 NBR B247	P 6	24005085	-		○
	290	17	12	A795	DKH	AR5480-E5	-	○	
	290	17	12	U801	DKI	FD5480-A0	-	○	
270	285	12	10	U801	DSI	FG0135-D0	-	○	
	290	18	10,2	85 NBR B247	P 6	24005089	IP		●
	290	18	10,2	85 FKM K664	P 6	24339192	-		○
	295	16	12	88 NBR 101	AS	12745	-	○	○
280	295	12	10	U801	DSI	FG0136-D0	-	○	
	310	22	16	U801	DKI	FD5556-A0	-	○	
290	310	25	15,2	85 NBR B247	P 6	49014353	-		○
	305	12	10	U801	DSI	FG0138-D0	-	○	
	305	13,5	7,7	85 FKM K664	P 6	24145755	-		○
	305	15	7,7	85 NBR B247	P 6	24005096	IP		●
	320	22	16	U801	DKI	FD5584-E0	-	○	
	315	12	10	U801	DSI	FG0139-D0	-	○	
300	320	18	10,2	85 NBR B247	P 6	24005100	IP		●
	320	18	10,2	85 FKM K664	P 6	24170871	IP		●
	330	22	16	A795	DKH	AR5622-B5	-	○	
	330	22	16	U801	DKI	FD5622-A0	-	○	
310	340	22	16	A795	DKH	AR5668-B5	-	○	
315	345	22	16	A795	DKH	AR5685-B5	-	○	
320	340	16	12	88 NBR 101	AS	12747	-		○

d [mm]	D [mm]	H [mm]	L [mm]	Material	Design	Part No.	PU ¹⁾	US	EU
320	340	18	10,2	85 FKM K664	P 6	24123970	-		○
330	360	22	16	A795	DKH	AR5741-B5	-	○	
335	365	22	16	A795	DKH	AR5761-B5	-	○	
350	375	20	12,7	85 FKM K664	P 6	24068245	-		○
	380	25	15,2	85 NBR B247	P 6	24108805	-		○
360	380	18	10,2	85 NBR B247	P 6	24375894	-		○
365	390	20	12,7	85 NBR B247	P 6	24374800	-		○
370	390	18	10,2	85 NBR B247	P 6	24327520	-		○
380	400	18	10,2	85 NBR B247	P 6	24114551	-		○
	410	25	15,2	85 NBR B247	P 6	24005124	-		○
	410	25	15,2	85 FKM K664	P 6	24067592	-		○
400	420	16	12	88 NBR 101	AS	26976	-		○
	420	18	10,2	85 NBR B247	P 6	24005129	IP		●
	420	18	10,2	85 FKM K664	P 6	24149417	-		○
420	440	18	10,2	85 NBR B247	P 6	24090552	-		○
	450	25	15,2	85 NBR B247	P 6	24005133	-		○
	450	25	15,2	85 FKM K664	P 6	24222589	-		○
430	455	20	12,7	85 NBR B247	P 6	24073523	-		○
440	460	18	10,2	85 NBR B247	P 6	24197297	-		○
	480	18	24	A795	DKH	AR6021-B5	-	○	
450	470	18	10,2	85 NBR B247	P 6	24005139	IP		●
	470	18	10,2	85 FKM K664	P 6	24216086	-		○
460	480	18	10,2	85 NBR B247	P 6	24095767	-		○
	490	25	20	A795	DKH	AR6073-B5	-	○	
470	510	25	20	A795	DKH	AR6094-B5	-	○	
500	520	18	10,2	85 NBR B247	P 6	24005145	-		○
	520	18	10,2	85 FKM K664	P 6	24239807	-		○
	530	22	16	A795	DKH	AR6140-B5	-	○	
510	540	25	15,2	85 FKM K664	P 6	24350197	-		○
520	550	25	15,2	85 NBR B247	P 6	24193087	-		○
530	560	25	15,2	85 NBR B247	P 6	24005152	-		○
555	580	20	12,7	85 NBR B247	P 6	24092902	-		○
560	585	20	12,7	85 NBR B247	P 6	24079694	-		○
575	600	20	12,7	85 NBR B247	P 6	24085742	-		○
600	625	20	12,7	85 NBR B247	P 6	24112281	-		○
610	635	20	12,7	85 NBR B247	P 6	24138641	-		○
630	655	20	12,7	85 NBR B247	P 6	24073341	-		○
640	665	20	12,7	85 NBR B247	P 6	24133481	-		○
670	695	20	12,7	85 NBR B247	P 6	24075321	-		○
680	705	20	12,7	85 NBR B247	P 6	24170551	-		○
700	725	20	12,7	85 NBR B247	P 6	24356247	-		○
710	735	20	12,7	85 NBR B247	P 6	24075142	-		○
720	745	20	12,7	85 NBR B247	P 6	24181926	-		○
750	775	20	12,7	85 NBR B247	P 6	24104001	-		○
770	795	20	12,7	85 NBR B247	P 6	24343859	-		○
780	805	20	12,7	85 NBR B247	P 6	24100033	-		○
800	825	20	12,7	85 NBR B247	P 6	24069967	-		○
	830	25	15,2	85 FKM K664	P 6	24362636	-		○
850	875	20	12,7	85 NBR B247	P 6	24082304	-		○
880	905	20	12,7	85 NBR B247	P 6	24182227	-		○
900	925	20	12,7	85 NBR B247	P 6	24005167	-		○

Type	SNAP IN	AN		MRW		D		AN SH	
Standard	AS	AS		AS		AS		AS	
Shape									
Compound	Polyurethan 92 AU 9250	Polyurethan 90 HU2090	Hytrel HT2022	Polyurethan 92 AU 9250	Polyurethan 94 AU 30000	Polyurethan 95 AU 2501	Hytrel HT2022	Polyurethan 95 AU 2501	Hytrel HT2022
 Fahrenheit									
 ft/s									
Applications									

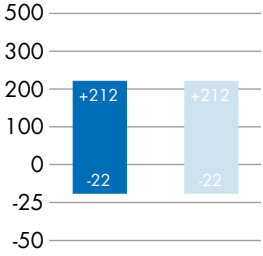
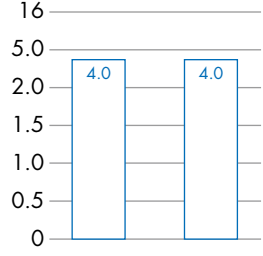
Bitte beachten Sie unsere allgemeinen Konstruktionshinweise in → Technisches Handbuch
 Daha detaylı montaj bilgisi için → Bkz. Technical Manual
 W celu zaznajomienia się z ogólnymi uwagami proszę skorzystać z Instrukcji
 Общие технические рекомендации см. → Техническое руководство

D-SH	
AS	
	
Polyurethan 95 AU 2501	Hytrel HT2022
	
	
	

EINFACH WIRKENDE ABSTREIFER | TEK ETKİLİ SIYIRICILAR ZGARNIACZE POJEDYNCZE | ГРЯЗЕСЪЕМНИКИ ОДНОСТОРОННЕГО ДЕЙСТВИЯ

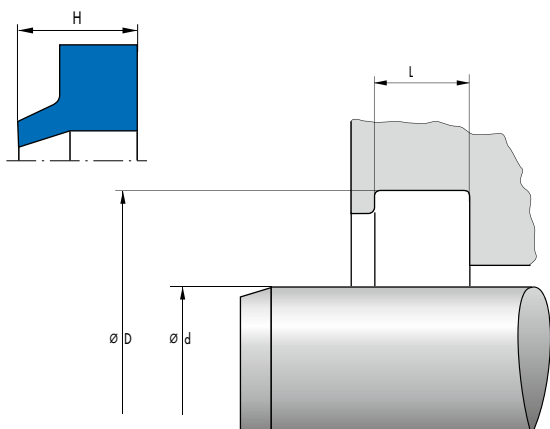

Wenn Sie Ihre Dichtung nicht finden können – Ihre Lösung auf Seite 12
Aradığınız ürünü bulamadığınız takdirde – çözümünüz sayfa 12
Jeżeli nie możecie Państwo znaleźć uszczelki – rozwiązanie znajduje się na stronie 12
Вы не можете подобрать необходимое уплотнение? – Решение на странице 12

1) IP = Industriepackung | Endüstriyel ambalaj | Opakowania przemysłowe | Производственная тара
SP = Einzelpackung | Tek bir Paketi | Pojedyncze opakowanie | Single Pack

● Auf Lager | Stoklarda mevcuttur | Dostępne w magazynie | Имеется в наличии на складе
○ Auf Anfrage | Talep üzerine | Na zapytanie | По запросу

d [inch]	D [inch]	H [inch]	L [inch]	Material	Design	Part No.	PU ¹⁾	US	EU
0,188	0,438	0,188	0,125	92 AU 9250	SNAP IN	560006002000A	–	●	
	0,497	0,185	0,124	95 AU 2501	D	56D-0250	–	○	
0,25	0,497	0,185	0,124	93 AU 2093	D-SH	56D-0250-SH	–	○	
	0,5	0,188	0,125	92 AU 9250	SNAP IN	560006003000A	–	○	
0,312	0,56	0,185	0,124	95 AU 2501	D	56D-0312	–	○	
	0,56	0,185	0,124	93 AU 2093	D-SH	56D-0312-SH	–	○	
0,313	0,563	0,188	0,125	92 AU 9250	SNAP IN	560006004000A	–	●	
	0,622	0,185	0,124	95 AU 2501	D	56D-0375	–	○	
0,375	0,622	0,185	0,124	HT 2022	D	56D-0375-2022	–	○	
	0,622	0,185	0,124	93 AU 2093	D-SH	56D-0375-SH	–	○	
	0,625	0,188	0,125	92 AU 9250	SNAP IN	560006005000A	–	●	
0,437	0,685	0,185	0,124	95 AU 2501	D	56D-0437	–	○	
	0,685	0,185	0,124	HT 2022	D	56D-0437-2022	–	○	
0,5	0,747	0,185	0,124	95 AU 2501	D	56D-0500	–	○	
	0,747	0,185	0,124	HT 2022	D	56D-0500-2022	–	○	
	0,747	0,185	0,124	93 AU 2093	D-SH	56D-0500-SH	–	●	
	0,75	0,188	0,125	92 AU 9250	SNAP IN	560006007000A	–	●	
	0,76	0,185	0,107	HT 2022	AN	56AN-01-2022	–	○	
	0,76	0,185	0,107	95 AU 2501	AN SH	56AN-01-SH	–	●	
	0,76	0,185	0,107	HT 2022	AN SH	56AN-01-SH-2022	–	○	
0,562	0,81	0,185	0,124	95 AU 2501	D	56D-0562	–	○	
	0,81	0,185	0,124	93 AU 2093	D-SH	56D-0562-SH	–	○	
0,563	0,813	0,188	0,125	92 AU 9250	SNAP IN	560006008000A	–	○	
	0,823	0,185	0,107	95 AU 2501	AN	56AN-02	–	●	
	0,823	0,185	0,107	HT 2022	AN	56AN-02-2022	–	○	
	0,823	0,185	0,107	95 AU 2501	AN SH	56AN-02-SH	–	○	
0,625	0,872	0,185	0,124	95 AU 2501	D	56D-0625	–	○	
	0,872	0,185	0,124	HT 2022	D	56D-0625-2022	–	○	
	0,872	0,185	0,124	93 AU 2093	D-SH	56D-0625-SH	–	●	

d [inch]	D [inch]	H [inch]	L [inch]	Material	Design	Part No.	PU ¹⁾	US	EU
0,625	0,875	0,188	0,125	92 AU 9250	SNAP IN	560006009000A	-	●	
	0,885	0,185	0,107	95 AU 2501	AN	56AN-03	-	●	
	0,885	0,185	0,107	HT 2022	AN	56AN-03-2022	-	●	
	0,885	0,185	0,107	95 AU 2501	AN SH	56AN-03-SH	-	●	
0,687	1,125	0,313	0,313	92 AU 9250	MRW	560110003000A	-	●	
	0,934	0,185	0,124	93 AU 2093	D-SH	56D-0687-SH	-	○	
0,688	0,948	0,185	0,107	95 AU 2501	AN	56AN-04	-	○	
	0,948	0,185	0,107	HT 2022	AN	56AN-04-2022	-	○	
	0,948	0,185	0,107	95 AU 2501	AN SH	56AN-04-SH	-	○	
0,75	1,01	0,185	0,107	95 AU 2501	AN	56AN-05	-	●	
	1,01	0,185	0,107	HT 2022	AN	56AN-05-2022	-	○	
	1,01	0,185	0,107	95 AU 2501	AN SH	56AN-05-SH	-	●	
	1,01	0,185	0,107	HT 2022	AN SH	56AN-05-SH-2022	-	○	
	1,122	0,28	0,187	95 AU 2501	D	56D-0750	-	○	
	1,122	0,28	0,187	HT 2022	D	56D-0750-2022	-	○	
	1,122	0,28	0,187	93 AU 2093	D-SH	56D-0750-SH	-	●	
	1,125	0,281	0,187	92 AU 9250	SNAP IN	560006011000A	-	●	
	1,25	0,25	0,25	92 AU 9250	MRW	560110004000A	-	●	
0,812	1,25	0,313	0,313	92 AU 9250	MRW	560110005000A	-	●	
	1,184	0,28	0,187	95 AU 2501	D	56D-0812	-	○	
0,813	1,184	0,28	0,187	93 AU 2093	D-SH	56D-0812-SH	-	○	
	1,084	0,185	0,107	95 AU 2501	AN	56AN-06	-	○	
	1,084	0,185	0,107	95 AU 2501	AN SH	56AN-06-SH	-	○	
0,875	1,187	0,281	0,187	92 AU 9250	SNAP IN	560006012000A	-	○	
	1,147	0,185	0,107	95 AU 2501	AN	56AN-07	-	○	
	1,147	0,185	0,107	HT 2022	AN	56AN-07-2022	-	○	
	1,147	0,185	0,107	95 AU 2501	AN SH	56AN-07-SH	-	●	
	1,247	0,28	0,187	95 AU 2501	D	56D-0875	-	●	
	1,247	0,28	0,187	HT 2022	D	56D-0875-2022	-	○	
	1,247	0,28	0,187	93 AU 2093	D-SH	56D-0875-SH	-	●	
	1,25	0,281	0,187	92 AU 9250	SNAP IN	560006013000A	-	●	
0,937	1,375	0,313	0,313	92 AU 9250	MRW	560110007000A	-	●	
	1,309	0,28	0,187	95 AU 2501	D	56D-0937	-	○	
1	0,938	1,209	0,185	0,107	95 AU 2501	AN	56AN-08	-	○
	1,272	0,185	0,107	95 AU 2501	AN	56AN-09	-	○	
	1,272	0,185	0,107	HT 2022	AN	56AN-09-2022	-	●	
	1,272	0,185	0,107	95 AU 2501	AN SH	56AN-09-SH	-	●	
	1,272	0,185	0,107	HT 2022	AN SH	56AN-09-SH-2022	-	○	
	1,372	0,28	0,187	95 AU 2501	D	56D-1000	-	○	
	1,372	0,28	0,187	HT 2022	D	56D-1000-2022	-	○	
	1,372	0,28	0,187	93 AU 2093	D-SH	56D-1000-SH	-	●	
	1,375	0,281	0,187	92 AU 9250	SNAP IN	560006015000A	-	○	
	1,5	0,313	0,313	92 AU 9250	MRW	560110008000A	-	●	
1,062	1,434	0,28	0,187	95 AU 2501	D	56D-1062	-	○	
	1,434	0,28	0,187	93 AU 2093	D-SH	56D-1062-SH	-	○	
	1,437	0,266	0,187	92 AU 9250	SNAP IN	560006016Y00A	-	○	
1,063	1,334	0,185	0,107	95 AU 2501	AN	56AN-10	-	○	
	1,334	0,185	0,107	HT 2022	AN	56AN-10-2022	-	○	
	1,334	0,185	0,107	95 AU 2501	AN SH	56AN-10-SH	-	○	
	1,437	0,281	0,187	92 AU 9250	SNAP IN	560006016000A	-	●	

d [inch]	D [inch]	H [inch]	L [inch]	Material	Design	Part No.	PU ¹⁾	US	EU
1,125	1,397	0,185	0,107	95 AU 2501	AN	56AN-11	-	○	
	1,397	0,185	0,107	HT 2022	AN	56AN-11-2022	-	○	
	1,397	0,185	0,107	95 AU 2501	AN SH	56AN-11-SH	-	●	
	1,397	0,185	0,107	HT 2022	AN SH	56AN-11-SH-2022	-	○	
	1,497	0,28	0,187	95 AU 2501	D	56D-1125	-	○	
	1,497	0,28	0,187	HT 2022	D	56D-1125-2022	-	○	
	1,497	0,28	0,187	93 AU 2093	D-SH	56D-1125-SH	-	○	
	1,5	0,281	0,187	92 AU 9250	SNAP IN	560006017000A	-	●	
1,187	1,625	0,313	0,313	92 AU 9250	MRW	560110009000A	-	●	
	1,559	0,28	0,187	95 AU 2501	D	56D-1187	-	○	
1,188	1,559	0,28	0,187	93 AU 2093	D-SH	56D-1187-SH	-	○	
	1,459	0,185	0,107	95 AU 2501	AN	56AN-12	-	○	
	1,459	0,185	0,107	HT 2022	AN	56AN-12-2022	-	○	
	1,459	0,185	0,107	95 AU 2501	AN SH	56AN-12-SH	-	○	
1,25	1,562	0,281	0,187	92 AU 9250	SNAP IN	560006018000A	-	○	
	1,522	0,185	0,107	95 AU 2501	AN	56AN-13	-	○	
	1,522	0,185	0,107	HT 2022	AN	56AN-13-2022	-	○	
	1,522	0,185	0,107	95 AU 2501	AN SH	56AN-13-SH	-	●	
	1,522	0,185	0,107	HT 2022	AN SH	56AN-13-SH-2022	-	○	
	1,622	0,28	0,187	95 AU 2501	D	56D-1250	-	○	
	1,622	0,28	0,187	HT 2022	D	56D-1250-2022	-	○	
	1,622	0,28	0,187	93 AU 2093	D-SH	56D-1250-SH	-	●	
	1,622	0,28	0,187	HT 2022	D-SH	56D-1250-SH-2022	-	○	
	1,625	0,281	0,187	92 AU 9250	SNAP IN	560006019000A	-	●	
1,313	1,75	0,25	0,25	92 AU 9250	MRW	560110010000A	-	●	
	1,75	0,313	0,313	92 AU 9250	MRW	560110011000A	-	●	
1,375	1,614	0,185	0,107	95 AU 2501	AN	56AN-14	-	○	
	1,677	0,185	0,107	95 AU 2501	AN	56AN-15	-	●	
	1,677	0,185	0,107	HT 2022	AN	56AN-15-2022	-	●	
	1,677	0,185	0,107	95 AU 2501	AN SH	56AN-15-SH	-	●	
	1,677	0,185	0,107	HT 2022	AN SH	56AN-15-SH-2022	-	○	
	1,747	0,28	0,187	95 AU 2501	D	56D-1375	-	○	
	1,747	0,28	0,187	HT 2022	D	56D-1375-2022	-	○	
	1,747	0,28	0,187	93 AU 2093	D-SH	56D-1375-SH	-	○	
	1,75	0,281	0,187	92 AU 9250	SNAP IN	560006021000A	-	●	
1,5	1,875	0,313	0,313	92 AU 9250	MRW	560110012000A	-	●	
	1,802	0,185	0,107	95 AU 2501	AN	56AN-17	-	○	
	1,802	0,185	0,107	HT 2022	AN	56AN-17-2022	-	○	
	1,802	0,185	0,107	95 AU 2501	AN SH	56AN-17-SH	-	●	
	1,802	0,185	0,107	HT 2022	AN SH	56AN-17-SH-2022	-	○	
	1,872	0,28	0,187	95 AU 2501	D	56D-1500	-	●	
	1,872	0,28	0,187	HT 2022	D	56D-1500-2022	-	○	
	1,872	0,28	0,187	93 AU 2093	D-SH	56D-1500-SH	-	●	
	1,872	0,28	0,187	HT 2022	D-SH	56D-1500-SH-2022	-	○	
	1,875	0,187	0,188	92 AU 9250	MRW	560110122000A	-	○	
	1,875	0,25	0,25	92 AU 9250	MRW	560110013000A	-	●	
	1,875	0,281	0,187	92 AU 9250	SNAP IN	560006022000A	-	●	
2	0,25	0,25	92 AU 9250	MRW	560110014000A	-	●		
2	0,313	0,313	92 AU 9250	MRW	560110015000A	-	●		
2,25	0,375	0,375	92 AU 9250	MRW	560110016000A	-	●		

d [inch]	D [inch]	H [inch]	L [inch]	Material	Design	Part No.	PU ¹⁾	US	EU	
1,625	1,927	0,185	0,107	95 AU 2501	AN	56AN-18	-	○		
	1,927	0,185	0,107	HT 2022	AN	56AN-18-2022	-	○		
	1,997	0,28	0,187	95 AU 2501	D	56D-1625	-	○		
	1,997	0,28	0,187	HT 2022	D	56D-1625-2022	-	○		
	1,997	0,28	0,187	93 AU 2093	D-SH	56D-1625-SH	-	○		
	2	0,281	0,187	92 AU 9250	SNAP IN	560006023000A	-	○		
	2,125	0,25	0,25	92 AU 9250	MRW	560110017000A	-	●		
	2,125	0,313	0,313	92 AU 9250	MRW	560110018000A	-	●		
1,75	2,052	0,185	0,107	95 AU 2501	AN	56AN-19	-	○		
	2,052	0,185	0,107	HT 2022	AN	56AN-19-2022	-	○		
	2,052	0,185	0,107	95 AU 2501	AN SH	56AN-19-SH	-	●		
	2,052	0,185	0,107	HT 2022	AN SH	56AN-19-SH-2022	-	○		
	2,122	0,28	0,187	95 AU 2501	D	56D-1750	-	○		
	2,122	0,28	0,187	HT 2022	D	56D-1750-2022	-	○		
	2,122	0,28	0,187	93 AU 2093	D-SH	56D-1750-SH	-	●		
	2,122	0,28	0,187	HT 2022	D-SH	56D-1750-SH-2022	-	○		
	2,125	0,281	0,187	92 AU 9250	SNAP IN	560006024000A	-	●		
	2,25	0,25	0,25	92 AU 9250	MRW	560110019000A	-	●		
	2,25	0,313	0,313	92 AU 9250	MRW	560110020000A	-	●		
	2,438	0,375	0,375	92 AU 9250	MRW	560110021000A	-	●		
1,812	2,114	0,185	0,107	95 AU 2501	AN	56AN-19.5	-	○		
	2,114	0,185	0,107	95 AU 2501	AN SH	56AN-19.5-SH	-	○		
1,875	2,177	0,185	0,107	95 AU 2501	AN	56AN-20	-	○		
	2,177	0,185	0,107	95 AU 2501	AN SH	56AN-20-SH	-	●		
	2,247	0,28	0,187	95 AU 2501	D	56D-1875	-	○		
	2,247	0,28	0,187	HT 2022	D	56D-1875-2022	-	○		
	2,247	0,28	0,187	93 AU 2093	D-SH	56D-1875-SH	-	○		
	2,25	0,281	0,187	92 AU 9250	SNAP IN	560006025000A	-	○		
	2,375	0,313	0,313	92 AU 9250	MRW	560110022000A	-	●		
2	2,302	0,185	0,107	95 AU 2501	AN	56AN-21	-	○		
	2,302	0,185	0,107	HT 2022	AN	56AN-21-2022	-	●		
	2,302	0,185	0,107	95 AU 2501	AN SH	56AN-21-SH	-	●		
	2,302	0,185	0,107	HT 2022	AN SH	56AN-21-SH-2022	-	○		
	2,497	0,38	0,249	95 AU 2501	D	56D-2000	-	●		
	2,497	0,38	0,249	HT 2022	D	56D-2000-2022	-	○		
	2,497	0,38	0,249	93 AU 2093	D-SH	56D-2000-SH	-	●		
	2,497	0,38	0,249	HT 2022	D-SH	56D-2000-SH-2022	-	○		
	2,5	0,25	0,25	92 AU 9250	MRW	560110023000A	-	●		
	2,5	0,313	0,313	92 AU 9250	MRW	560110024000A	-	●		
	2,5	0,375	0,25	92 AU 9250	SNAP IN	560006026000A	-	●		
	2,625	0,25	0,25	92 AU 9250	MRW	560110025000A	-	●		
	2,688	0,375	0,375	92 AU 9250	MRW	560110026000A	-	●		
	2,125	2,427	0,185	0,107	95 AU 2501	AN	56AN-22	-	○	
		2,622	0,38	0,249	95 AU 2501	D	56D-2125	-	○	
2,622		0,38	0,249	HT 2022	D	56D-2125-2022	-	○		
2,625		0,313	0,313	92 AU 9250	MRW	560110027000A	-	●		
2,625		0,375	0,25	92 AU 9250	SNAP IN	006027000A	-	○		
2,25	2,552	0,185	0,107	95 AU 2501	AN	56AN-23	-	○		
	2,552	0,185	0,107	HT 2022	AN	56AN-23-2022	-	○		
	2,552	0,185	0,107	95 AU 2501	AN SH	56AN-23-SH	-	○		

d [inch]	D [inch]	H [inch]	L [inch]	Material	Design	Part No.	PU ¹⁾	US	EU
2,25	2,747	0,38	0,249	95 AU 2501	D	56D-2250	-	○	
	2,747	0,38	0,249	HT 2022	D	56D-2250-2022	-	○	
	2,747	0,38	0,249	93 AU 2093	D-SH	56D-2250-SH	-	●	
	2,75	0,25	0,25	92 AU 9250	MRW	560110029000A	-	●	
	2,75	0,313	0,313	92 AU 9250	MRW	560110030000A	-	●	
	2,75	0,375	0,25	92 AU 9250	SNAP IN	560006028000A	-	○	
	3	0,375	0,375	92 AU 9250	MRW	560110032000A	-	●	
2,312	2,614	0,185	0,107	95 AU 2501	AN SH	56AN-23.5-SH	-	○	
2,313	3,125	0,375	0,375	92 AU 9250	MRW	560110034000A	-	●	
2,375	2,677	0,185	0,107	95 AU 2501	AN	56AN-24	-	○	
	2,677	0,185	0,107	HT 2022	AN	56AN-24-2022	-	○	
	2,677	0,185	0,107	95 AU 2501	AN SH	56AN-24-SH	-	○	
	2,677	0,185	0,107	HT 2022	AN SH	56AN-24-SH-2022	-	○	
	2,872	0,38	0,249	95 AU 2501	D	56D-2375	-	○	
	2,872	0,38	0,249	HT 2022	D	56D-2375-2022	-	○	
	2,872	0,38	0,249	93 AU 2093	D-SH	56D-2375-SH	-	●	
	2,875	0,313	0,313	92 AU 9250	MRW	560110035000A	-	●	
	2,875	0,375	0,25	92 AU 9250	SNAP IN	560006029000A	-	○	
	3,125	0,375	0,375	92 AU 9250	MRW	560110036000A	-	●	
	2,437	2,74	0,185	0,107	95 AU 2501	AN	56AN-24.5	-	○
2,5	2,802	0,185	0,107	95 AU 2501	AN	56AN-25	-	●	
	2,802	0,185	0,107	HT 2022	AN	56AN-25-2022	-	○	
	2,802	0,185	0,107	95 AU 2501	AN SH	56AN-25-SH	-	●	
	2,802	0,185	0,107	HT 2022	AN SH	56AN-25-SH-2022	-	○	
	2,997	0,38	0,249	95 AU 2501	D	56D-2500	-	●	
	2,997	0,38	0,249	HT 2022	D	56D-2500-2022	-	○	
	2,997	0,38	0,249	93 AU 2093	D-SH	56D-2500-SH	-	●	
	2,997	0,38	0,249	HT 2022	D-SH	56D-2500-SH-2022	-	○	
	3	0,187	0,187	92 AU 9250	MRW	560110131000A	-	○	
	3	0,313	0,313	92 AU 9250	MRW	560110037000A	-	●	
	3	0,375	0,25	92 AU 9250	SNAP IN	560006030000A	-	●	
	3,25	0,25	0,25	92 AU 9250	MRW	560110038000A	-	●	
	3,25	0,375	0,375	92 AU 9250	MRW	560110039000A	-	●	
	2,562	2,864	0,185	0,107	95 AU 2501	AN	56AN-25.5	-	○
2,864		0,185	0,107	95 AU 2501	AN SH	56AN-25.5-SH	-	○	
2,563	3,06	0,38	0,249	95 AU 2501	D	56D-2562	-	○	
	3,06	0,38	0,249	93 AU 2093	D-SH	56D-2562-SH	-	○	
2,625	2,989	0,205	0,122	95 AU 2501	AN	56AN-26	-	○	
	3,122	0,38	0,249	95 AU 2501	D	56D-2625	-	○	
	3,122	0,38	0,249	93 AU 2093	D-SH	56D-2625-SH	-	○	
	3,125	0,25	0,25	92 AU 9250	MRW	560110040000A	-	●	
	3,125	0,313	0,313	92 AU 9250	MRW	560110041000A	-	●	
	3,114	0,205	0,122	95 AU 2501	AN	56AN-27	-	○	
2,75	3,114	0,205	0,122	HT 2022	AN	56AN-27-2022	-	○	
	3,114	0,205	0,122	95 AU 2501	AN SH	56AN-27-SH	-	●	
	3,247	0,38	0,249	95 AU 2501	D	56D-2750	-	○	
	3,247	0,38	0,249	HT 2022	D	56D-2750-2022	-	○	
	3,247	0,38	0,249	93 AU 2093	D-SH	56D-2750-SH	-	●	
	3,247	0,38	0,249	HT 2022	D-SH	56D-2750-SH-2022	-	○	
	3,247	0,38	0,249	93 AU 2093	D-SH	56D-2750-SH	-	●	
	3,25	0,187	0,187	92 AU 9250	MRW	560110120000A	-	○	











d [inch]	D [inch]	H [inch]	L [inch]	Material	Design	Part No.	PU ¹⁾	US	EU
2,75	3,25	0,313	0,313	92 AU 9250	MRW	560110042000A	-	●	
	3,25	0,375	0,25	92 AU 9250	SNAP IN	560006032000A	-	●	
	3,5	0,25	0,25	92 AU 9250	MRW	560110043000A	-	●	
	3,75	0,5	0,5	92 AU 9250	MRW	560110045000A	-	●	
2,875	3,239	0,205	0,122	95 AU 2501	AN	56AN-28	-	○	
	3,372	0,38	0,249	95 AU 2501	D	56D-2875	-	○	
	3,372	0,38	0,249	HT 2022	D	56D-2875-2022	-	○	
	3,375	0,313	0,313	92 AU 9250	MRW	560110046000A	-	○	
	3,375	0,375	0,25	92 AU 9250	SNAP IN	006033000A	-	○	
3	3,364	0,205	0,122	95 AU 2501	AN	56AN-29	-	●	
	3,364	0,205	0,122	HT 2022	AN	56AN-29-2022	-	○	
	3,364	0,205	0,122	95 AU 2501	AN SH	56AN-29-SH	-	○	
	3,364	0,205	0,122	HT 2022	AN SH	56AN-29-SH-2022	-	○	
	3,497	0,38	0,249	95 AU 2501	D	56D-3000	-	○	
	3,497	0,38	0,249	HT 2022	D	56D-3000-2022	-	○	
	3,497	0,38	0,249	93 AU 2093	D-SH	56D-3000-SH	-	●	
	3,497	0,38	0,249	HT 2022	D-SH	56D-3000-SH-2022	-	○	
	3,5	0,313	0,313	92 AU 9250	MRW	560110047000A	-	●	
	3,5	0,375	0,25	92 AU 9250	SNAP IN	560006034000A	-	●	
	3,75	0,25	0,25	92 AU 9250	MRW	560110048000A	-	●	
	4	0,5	0,5	92 AU 9250	MRW	560110049000A	-	●	
	3,125	3,489	0,205	0,122	95 AU 2501	AN	56AN-30	-	○
3,489		0,205	0,122	HT 2022	AN	56AN-30-2022	-	○	
3,622		0,38	0,249	95 AU 2501	D	56D-3125	-	○	
3,75		0,375	0,375	92 AU 9250	MRW	560110108000A	-	●	
3,25	3,616	0,205	0,122	95 AU 2501	AN	56AN-31	-	○	
	3,616	0,205	0,122	HT 2022	AN	56AN-31-2022	-	○	
	3,616	0,205	0,122	95 AU 2501	AN SH	56AN-31-SH	-	○	
	3,747	0,38	0,249	95 AU 2501	D	56D-3250	-	○	
	3,747	0,38	0,249	HT 2022	D	56D-3250-2022	-	○	
	3,747	0,38	0,249	93 AU 2093	D-SH	56D-3250-SH	-	○	
	3,75	0,313	0,313	92 AU 9250	MRW	560110109000A	-	●	
	3,75	0,375	0,25	92 AU 9250	SNAP IN	560006036000A	-	●	
	3,875	0,313	0,313	92 AU 9250	MRW	560110052000A	-	●	
	4	0,25	0,25	92 AU 9250	MRW	560110053000A	-	○	
	4,25	0,5	0,5	92 AU 9250	MRW	560110054000A	-	●	
3,375	3,729	0,205	0,122	95 AU 2501	AN	56AN-32	-	○	
	3,729	0,205	0,122	HT 2022	AN	56AN-32-2022	-	○	
	3,872	0,38	0,249	95 AU 2501	D	56D-3375	-	○	
	3,872	0,38	0,249	93 AU 2093	D-SH	56D-3375-SH	-	○	
	4	0,313	0,313	92 AU 9250	MRW	560110055000A	-	●	
3,5	3,864	0,205	0,122	95 AU 2501	AN	56AN-33	-	●	
	3,864	0,205	0,122	HT 2022	AN	56AN-33-2022	-	○	
	3,864	0,205	0,122	95 AU 2501	AN SH	56AN-33-SH	-	●	
	3,864	0,205	0,122	HT 2022	AN SH	56AN-33-SH-2022	-	○	
	3,997	0,38	0,249	HT 2022	D	56D-3500-2022	-	○	
	3,997	0,38	0,249	93 AU 2093	D-SH	56D-3500-SH	-	●	
	4	0,313	0,313	92 AU 9250	MRW	560110056000A	-	●	
	4	0,375	0,25	92 AU 9250	SNAP IN	560006038000A	-	●	
	4,125	0,313	0,313	92 AU 9250	MRW	560110058000A	-	●	

d [inch]	D [inch]	H [inch]	L [inch]	Material	Design	Part No.	PU ¹⁾	US	EU
3,5	4,25	0,25	0,25	92 AU 9250	MRW	560110059000A	-	●	
	4,5	0,5	0,5	92 AU 9250	MRW	560110060000A	-	●	
3,625	3,989	0,205	0,122	95 AU 2501	AN	56AN-34	-	○	
	3,989	0,205	0,122	HT 2022	AN	56AN-34-2022	-	○	
	4,122	0,38	0,249	95 AU 2501	D	56D-3625	-	○	
	4,114	0,205	0,122	95 AU 2501	AN	56AN-35	-	○	
	4,114	0,205	0,122	HT 2022	AN	56AN-35-2022	-	○	
	4,247	0,38	0,249	95 AU 2501	D	56D-3750	-	○	
3,75	4,247	0,38	0,249	HT 2022	D	56D-3750-2022	-	○	
	4,25	0,187	0,187	92 AU 9250	MRW	560110132000A	-	○	
	4,25	0,375	0,25	92 AU 9250	SNAP IN	560006041000A	-	○	
	4,375	0,313	0,313	92 AU 9250	MRW	560110063000A	-	●	
	4,5	0,313	0,313	92 AU 9250	MRW	560110062000A	-	●	
	4,75	0,5	0,5	92 AU 9250	MRW	560110064000A	-	●	
3,875	4,239	0,205	0,122	95 AU 2501	AN	56AN-36	-	○	
	4,239	0,205	0,122	HT 2022	AN	56AN-36-2022	-	○	
	4,372	0,38	0,249	95 AU 2501	D	56D-3875	-	●	
	4,427	0,215	0,138	95 AU 2501	AN	56AN-37	-	●	
	4,427	0,215	0,138	HT 2022	AN	56AN-37-2022	-	○	
	4,427	0,215	0,138	95 AU 2501	AN SH	56AN-37-SH	-	●	
	4,427	0,215	0,138	HT 2022	AN SH	56AN-37-SH-2022	-	○	
	4,497	0,38	0,249	95 AU 2501	D	56D-4000	-	○	
	4,497	0,38	0,249	HT 2022	D	56D-4000-2022	-	○	
	4,497	0,38	0,249	93 AU 2093	D-SH	56D-4000-SH	-	●	
4	4,5	0,375	0,25	92 AU 9250	SNAP IN	560006044000A	-	●	
	4,625	0,313	0,313	92 AU 9250	MRW	560110066000A	-	●	
	4,625	0,469	0,312	92 AU 9250	SNAP IN	006043000A	-	●	
	4,75	0,313	0,313	92 AU 9250	MRW	560110067000A	-	●	
	5	0,5	0,5	92 AU 9250	MRW	560110068000A	-	●	
	4,552	0,215	0,138	95 AU 2501	AN	56AN-38	-	○	
	4,622	0,38	0,249	95 AU 2501	D	56D-4125	-	○	
	4,622	0,38	0,249	93 AU 2093	D-SH	56D-4125-SH	-	○	
4,25	4,667	0,215	0,138	95 AU 2501	AN	56AN-39	-	○	
	4,667	0,215	0,138	HT 2022	AN	56AN-39-2022	-	○	
	4,667	0,215	0,138	95 AU 2501	AN SH	56AN-39-SH	-	●	
	4,747	0,38	0,249	95 AU 2501	D	56D-4250	-	○	
	4,747	0,38	0,249	HT 2022	D	56D-4250-2022	-	○	
	4,747	0,38	0,249	93 AU 2093	D-SH	56D-4250-SH	-	○	
	4,75	0,313	0,313	92 AU 9250	MRW	560110070000A	-	●	
	5,25	0,5	0,5	92 AU 9250	MRW	560110072000A	-	●	
4,375	4,802	0,215	0,138	95 AU 2501	AN	56AN-40	-	○	
	4,802	0,215	0,138	HT 2022	AN	56AN-40-2022	-	○	
	4,872	0,38	0,249	95 AU 2501	D	56D-4375	-	○	
	4,872	0,38	0,249	93 AU 2093	D-SH	56D-4375-SH	-	○	
	5	0,313	0,313	92 AU 9250	MRW	560110073000A	-	●	
	5,313	0,469	0,312	92 AU 9250	SNAP IN	006048000A	-	○	
4,5	4,927	0,215	0,138	95 AU 2501	AN	56AN-41	-	○	
	4,927	0,215	0,138	HT 2022	AN	56AN-41-2022	-	○	
	4,927	0,215	0,138	95 AU 2501	AN SH	56AN-41-SH	-	●	
	4,927	0,215	0,138	HT 2022	AN SH	56AN-41-SH-2022	-	○	

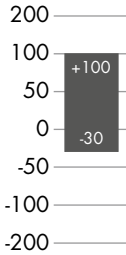
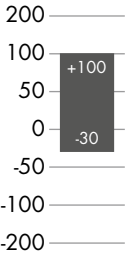
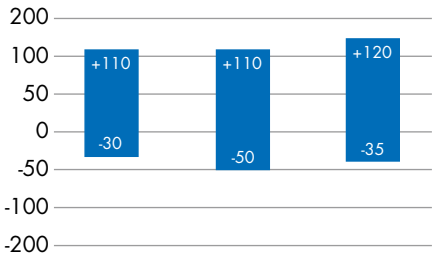
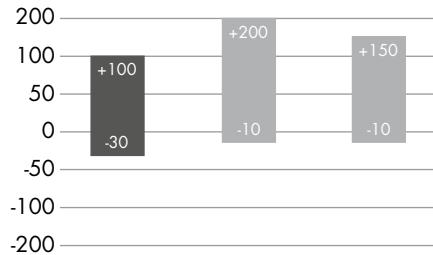

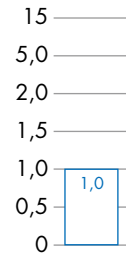
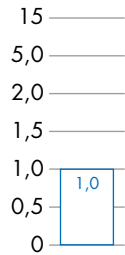
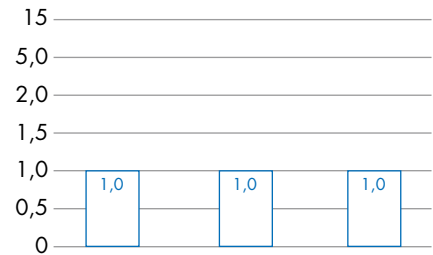
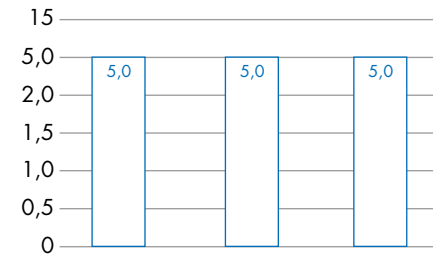





d [inch]	D [inch]	H [inch]	L [inch]	Material	Design	Part No.	PU ¹⁾	US	EU
4,5	5,125	0,313	0,313	92 AU 9250	MRW	560110074000A	-	●	
	5,247	0,585	0,374	95 AU 2501	D	56D-4500	-	○	
	5,247	0,585	0,374	HT 2022	D	56D-4500-2022	-	○	
	5,247	0,585	0,374	93 AU 2093	D-SH	56D-4500-SH	-	●	
	5,25	0,313	0,313	92 AU 9250	MRW	560110110000A	-	●	
	5,25	0,563	0,375	92 AU 9250	SNAP IN	006050000A	-	○	
	5,5	0,313	0,313	92 AU 9250	MRW	560110077000A	-	●	
	5,5	0,5	0,5	92 AU 9250	MRW	560110078000A	-	●	
4,625	5,052	0,215	0,138	95 AU 2501	AN	56AN-42	-	○	
	5,052	0,215	0,138	95 AU 2501	AN SH	56AN-42-SH	-	○	
	5,372	0,585	0,374	95 AU 2501	D	56D-4625	-	○	
	5,372	0,585	0,374	93 AU 2093	D-SH	56D-4625-SH	-	○	
4,75	5,177	0,215	0,138	95 AU 2501	AN	56AN-43	-	○	
	5,177	0,215	0,138	HT 2022	AN	56AN-43-2022	-	○	
	5,375	0,313	0,313	92 AU 9250	MRW	560110079000A	-	●	
	5,497	0,585	0,374	95 AU 2501	D	56D-4750	-	○	
	5,497	0,585	0,374	HT 2022	D	56D-4750-2022	-	○	
	5,497	0,585	0,374	93 AU 2093	D-SH	56D-4750-SH	-	○	
	5,75	0,5	0,5	92 AU 9250	MRW	560110080000A	-	●	
4,875	5,302	0,215	0,138	95 AU 2501	AN	56AN-44	-	○	
	5,622	0,585	0,374	95 AU 2501	D	56D-4875	-	○	
5	5,427	0,215	0,138	95 AU 2501	AN	56AN-45	-	●	
	5,427	0,215	0,138	HT 2022	AN	56AN-45-2022	-	○	
	5,427	0,215	0,138	95 AU 2501	AN SH	56AN-45-SH	-	○	
	5,625	0,313	0,313	92 AU 9250	MRW	560110111000A	-	○	
	5,747	0,585	0,374	95 AU 2501	D	56D-5000	-	○	
	5,747	0,585	0,374	93 AU 2093	D-SH	56D-5000-SH	-	●	
	5,75	0,313	0,313	92 AU 9250	MRW	560110082000A	-	●	
	5,75	0,594	0,375	92 AU 9250	SNAP IN	560006054000A	-	●	
5,125	5,552	0,215	0,138	95 AU 2501	AN	56AN-46	-	○	
	5,872	0,585	0,374	95 AU 2501	D	56D-5125	-	○	
	5,872	0,585	0,374	93 AU 2093	D-SH	56D-5125-SH	-	○	
5,25	5,667	0,215	0,138	95 AU 2501	AN	56AN-47	-	○	
	5,667	0,215	0,138	95 AU 2501	AN SH	56AN-47-SH	-	○	
	5,997	0,585	0,374	95 AU 2501	D	56D-5250	-	○	
	5,997	0,585	0,374	HT 2022	D	56D-5250-2022	-	○	
	5,997	0,585	0,374	93 AU 2093	D-SH	56D-5250-SH	-	○	
	6	0,313	0,313	92 AU 9250	MRW	560110084000A	-	●	
	6	0,563	0,375	92 AU 9250	SNAP IN	560006055000A	-	○	
5,375	5,902	0,215	0,138	95 AU 2501	AN	56AN-48	-	○	
	6,122	0,585	0,374	95 AU 2501	D	56D-5375	-	○	
5,5	5,927	0,215	0,138	95 AU 2501	AN	56AN-49	-	○	
	5,927	0,215	0,138	HT 2022	AN	56AN-49-2022	-	○	
	5,927	0,215	0,138	95 AU 2501	AN SH	56AN-49-SH	-	●	
	6,247	0,585	0,374	95 AU 2501	D	56D-5500	-	○	
	6,247	0,585	0,374	93 AU 2093	D-SH	56D-5500-SH	-	○	
	6,25	0,563	0,375	92 AU 9250	SNAP IN	560006057000A	-	○	
5,625	6,114	0,245	0,154	95 AU 2501	AN	56AN-50	-	○	
	6,114	0,245	0,154	HT 2022	AN	56AN-50-2022	-	○	
	6,372	0,585	0,374	95 AU 2501	D	56D-5625	-	○	





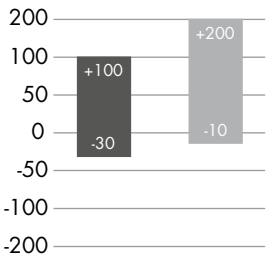
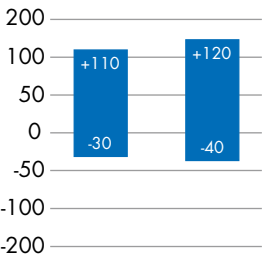
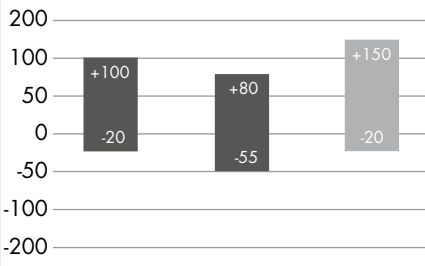
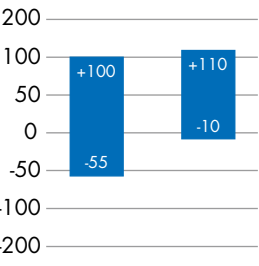
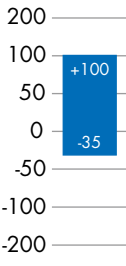
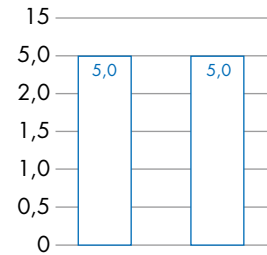
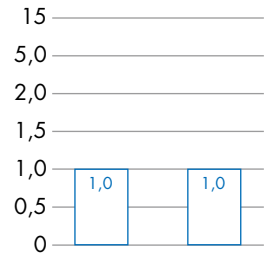
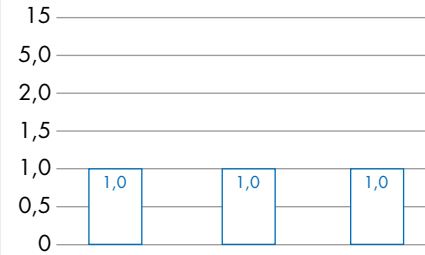
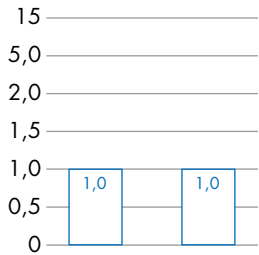
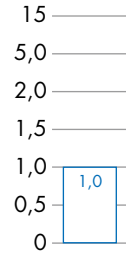

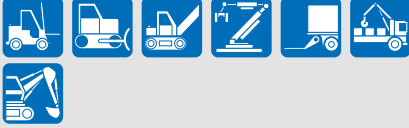
d [inch]	D [inch]	H [inch]	L [inch]	Material	Design	Part No.	PU ¹⁾	US	EU
5,75	6,239	0,245	0,154	95 AU 2501	AN	56AN-51	-	○	
	6,239	0,245	0,154	HT 2022	AN	56AN-51-2022	-	○	
	6,375	0,375	0,375	92 AU 9250	MRW	560110086000A	-	●	
	6,497	0,585	0,374	95 AU 2501	D	56D-5750	-	○	
	6,497	0,585	0,374	93 AU 2093	D-SH	56D-5750-SH	-	○	
6	6,489	0,245	0,154	95 AU 2501	AN	56AN-53	-	○	
	6,489	0,245	0,154	HT 2022	AN	56AN-53-2022	-	○	
	6,489	0,245	0,154	95 AU 2501	AN SH	56AN-53-SH	-	●	
	6,489	0,245	0,154	HT 2022	AN SH	56AN-53-SH-2022	-	○	
	6,625	0,375	0,375	92 AU 9250	MRW	560110087000A	-	●	
	6,747	0,585	0,374	95 AU 2501	D	56D-6000	-	○	
	6,747	0,585	0,374	93 AU 2093	D-SH	56D-6000-SH	-	●	
	6,75	0,375	0,375	92 AU 9250	MRW	560110114000A	-	○	
	6,75	0,563	0,375	92 AU 9250	SNAP IN	560006061000A	-	○	
	7	0,5	0,5	92 AU 9250	MRW	560110088000A	-	●	
6,25	6,739	0,245	0,154	95 AU 2501	AN	56AN-54	-	○	
	6,997	0,585	0,374	95 AU 2501	D	56D-6250	-	○	
6,5	6,989	0,245	0,154	95 AU 2501	AN	56AN-55	-	○	
	6,989	0,245	0,154	95 AU 2501	AN SH	56AN-55-SH	-	●	
	7,247	0,585	0,374	95 AU 2501	D	56D-6500	-	●	
	7,247	0,585	0,374	93 AU 2093	D-SH	56D-6500-SH	-	●	
	7,25	0,313	0,313	92 AU 9250	MRW	560110115000A	-	●	
7,5	0,625	0,625	92 AU 9250	MRW	560110089000A	-	●		
6,75	7,239	0,245	0,154	95 AU 2501	AN	56AN-56	-	○	
	7,239	0,245	0,154	HT 2022	AN	56AN-56-2022	-	○	
	7,239	0,245	0,154	95 AU 2501	AN SH	56AN-56-SH	-	○	
	7,497	0,585	0,374	95 AU 2501	D	56D-6750	-	○	
	7,75	0,5	0,5	92 AU 9250	MRW	560110090000A	-	○	
7	7,489	0,245	0,154	95 AU 2501	AN	56AN-57	-	○	
	7,489	0,245	0,154	HT 2022	AN	56AN-57-2022	-	○	
	7,747	0,585	0,374	95 AU 2501	D	56D-7000	-	○	
	7,747	0,585	0,374	93 AU 2093	D-SH	56D-7000-SH	-	●	
	8	0,5	0,5	92 AU 9250	MRW	560110092000A	-	●	
	8	0,68	0,4	92 AU 9250	SNAP IN	560006065Z00A	-	○	
	8	0,75	0,5	92 AU 9250	SNAP IN	560006065000A	-	●	
7,25	7,739	0,245	0,154	95 AU 2501	AN	56AN-58	-	○	
	7,739	0,245	0,154	HT 2022	AN	56AN-58-2022	-	○	
	7,997	0,585	0,374	95 AU 2501	D	56D-7250	-	○	
7,498	8,502	0,68	0,401	92 AU 9250	SNAP IN	006066Y00A	-	●	
7,5	7,989	0,245	0,154	95 AU 2501	AN	56AN-59	-	○	
	7,989	0,245	0,154	95 AU 2501	AN SH	56AN-59-SH	-	●	
	8,247	0,585	0,374	95 AU 2501	D	56D-7500	-	○	
7,75	8,239	0,245	0,154	95 AU 2501	AN SH	56AN-60-SH	-	○	
8	8,489	0,245	0,154	95 AU 2501	AN	56AN-61	-	○	
	8,489	0,245	0,154	95 AU 2501	AN SH	56AN-61-SH	-	●	
	8,747	0,585	0,374	95 AU 2501	D	56D-8000	-	○	
	8,747	0,585	0,374	93 AU 2093	D-SH	56D-8000-SH	-	●	
	9	0,75	0,5	92 AU 9250	SNAP IN	006067000A	-	○	
8,25	8,997	0,585	0,374	95 AU 2501	D	56D-8250	-	○	
	8,997	0,585	0,374	HT 2022	D	56D-8250-2022	-	○	

d [inch]	D [inch]	H [inch]	L [inch]	Material	Design	Part No.	PU ¹⁾	US	EU
8,5	8,989	0,245	0,154	95 AU 2501	AN	56AN-62	-	○	
	8,989	0,245	0,154	95 AU 2501	AN SH	56AN-62-SH	-	●	
	9,247	0,585	0,374	95 AU 2501	D	56D-8500	-	○	
8,75	9,497	0,585	0,374	95 AU 2501	D	56D-8750	-	○	
	9,489	0,245	0,154	95 AU 2501	AN	56AN-63	-	○	
9	9,489	0,245	0,154	HT 2022	AN	56AN-63-2022	-	○	
	9,489	0,245	0,154	95 AU 2501	AN SH	56AN-63-SH	-	○	
	9,747	0,585	0,374	95 AU 2501	D	56D-9000	-	○	
	9,747	0,585	0,374	93 AU 2093	D-SH	56D-9000-SH	-	○	
	9,752	0,551	0,551	92 AU 9250	MRW	560110123000A	-	●	
	10	0,75	0,5	92 AU 9250	SNAP IN	006069000A	-	●	
	9,25	9,739	0,245	0,154	95 AU 2501	AN	56AN-63.5	-	○
10	9,5	9,989	0,245	0,154	95 AU 2501	AN	56AN-64	-	○
	10,489	0,245	0,154	95 AU 2501	AN	56AN-65	-	●	
	10,997	0,71	0,499	93 AU 2093	D-SH	56D-10000-SH	-	○	
10,5	11	0,75	0,5	92 AU 9250	SNAP IN	006071000A	-	○	
	10,989	0,245	0,154	95 AU 2501	AN SH	56AN-66-SH	-	●	
	11,497	0,71	0,499	95 AU 2501	D	56D-10500	-	○	
11	11,489	0,245	0,154	95 AU 2501	AN	56AN-67	-	●	
	11,997	0,71	0,499	95 AU 2501	D	56D-11000	-	○	
	12,002	0,551	0,551	92 AU 9250	MRW	560110124000A	-	●	
12	12,489	0,275	0,169	95 AU 2501	AN	56AN-69	-	●	

Type	P 8	P 9	PRW 1			PT 1		
Standard	ISO	ISO	ISO			ISO		
Shape								
Compound	NBR 90 NBR 109 85 NBR B247	NBR 85 NBR B247	Polyurethan 94 AU 925	Polyurethan 92 AU 21 100	Polyurethan 94 AU 30000	PTFE/NBR B602/70 NBR GM201/70 NBR	PTFE/FKM B 602/70 FKM	PTFE/FKM GM201/70FKM
								
								
Applications								

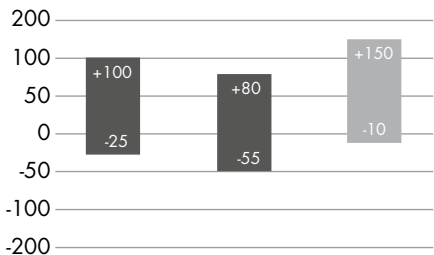
Bitte beachten Sie unsere allgemeinen Konstruktionshinweise in → Technisches Handbuch
 Daha detaylı montaj bilgisi için → Bkz. Technical Manual
 W celu zaznajomienia się z ogólnymi uwagami proszę skorzystać z Instrukcji
 Общие технические рекомендации см. → Техническое руководство

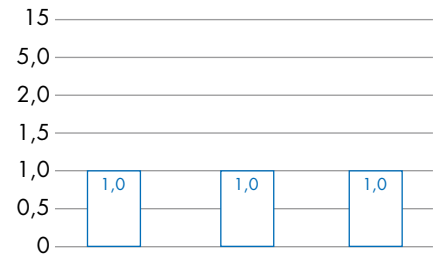
PT 2		PU 11		DKB			DKBI		LB1
ISO		ISO		JIS			JIS		JIS
									
PTFE/NBR B602/70 NBR	PTFE/FKM B602/70 KM	Polyurethan 95 AU V142	Polyurethan 94 AU 30000	NBR 80 A795	NBR 80 NBR A980	FKM 80 FKM F975	Polyurethan 94 U801	Polyurethan 94 U641	Polyurethan 92 U593
 <p>Temperature range: +100 to +200, -30 to -10</p>		 <p>Temperature range: +110 to +120, -30 to -40</p>		 <p>Temperature range: +100 to +150, -20 to -55</p>			 <p>Temperature range: +100 to +110, -55 to -10</p>		 <p>Temperature range: +100, -35</p>
 <p>Modulus: 5,0</p>		 <p>Modulus: 1,0</p>		 <p>Modulus: 1,0</p>			 <p>Modulus: 1,0</p>		 <p>Modulus: 1,0</p>
									

Type	LBH		
Standard	JIS		
Shape			
Compound	NBR 90 A505	NBR 82 A567	FKM 90 F357
			
			
Applications			

Bitte beachten Sie unsere allgemeinen Konstruktionshinweise in → Technisches Handbuch

Daha detaylı montaj bilgisi için → Bkz. Technical Manual

W celu zaznajomienia się z ogólnymi uwagami proszę skorzystać z Instrukcji

Общие технические рекомендации см. → Техническое руководство

DOPPELT WIRKENDE ABSTREIFER | ÇİFT ETKİLİ SIYIRICILAR ZGARNIACZE PODWÓJNIE | ГРЯЗЕСЪЕМНИКИ ДВУХСТОРОННЕГО ДЕЙСТВИЯ

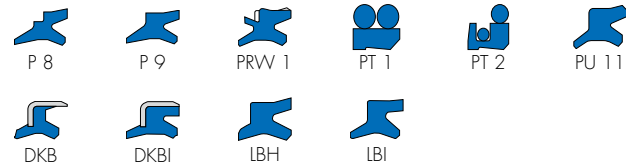
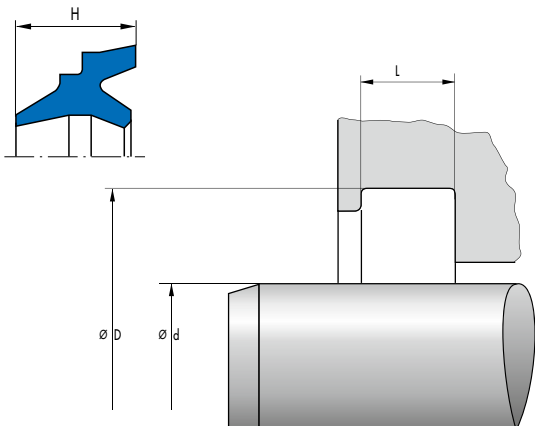

Wenn Sie Ihre Dichtung nicht finden können – Ihre Lösung auf Seite 12
Aradığınız ürünü bulamadığınız takdirde – çözümünüz sayfa 12
Jeżeli nie możecie Państwo znaleźć uszczelki – rozwiązanie znajduje się na stronie 12
Вы не можете подобрать необходимое уплотнение? – Решение на странице 12

1) IP = Industriepackung | Endüstriyel ambalaj | Opakowania przemysłowe | Производственная тара
SP = Einzelpackung | Tek bir Paket | Pojedyncze opakowanie | Single Pack

● Auf Lager | Stoklarda mevcuttur | Dostępne w magazynie | Имеется в наличии на складе
○ Auf Anfrage | Talep üzerine | Na zapytanie | По запросу

d [mm]	D [mm]	H [mm]	L [mm]	Material	Design	Part No.	PU ¹⁾	US	EU
10	17,6	4	4,2	PTFE B602/FKM	PT 1	24300912	–		○
	18	8	4	90 NBR 109	P 8	24224393	–		○
12	18	6	4	95 AU V142	PU 11	24348683 40422475	IP SP		● ●
	19,6	4	4,2	PTFE B602/NBR	PT 1	49000281	–		○
	20	6	5	A505	LBH	CL0480-C0	–	○	
	20	8	4	90 NBR 109	P 8	24224434	–		○
12,5	20,5	6	5	A505	LBH	CL0447-C1	–	○	
14	20	6	4	95 AU V142	PU 11	24348684 40422476	IP SP		● ●
	20	6	4	94 AU 30000	PU 11	49334481	–		○
	21,6	4	4,2	PTFE B602/NBR	PT 1	49000282	–		○
	22	6	5	A505	LBH	CL0432-C0	–	○	
	22	8	4	90 NBR 109	P 8	24224394	–		○
15	22,6	4	4,2	PTFE B602/NBR	PT 1	24380934	–		○
	22	6	4	95 AU V142	PU 11	24338682	–		○
16	23,6	4	4,2	PTFE B602/NBR	PT 1	24358499	–		○
	24	6	5	A505	LBH	CL0293-C0	–	○	
	24	6	5	F357	LBH	CL0293-C3	–	○	
	24	8	4	90 NBR 109	P 8	24224395	IP		●
	26	7	5	A795	DKB	AR0677-E5	–	○	
18	24	6	4	95 AU V142	PU 11	24338683 40422466	IP SP		● ●
	24	6	4	94 AU 30000	PU 11	49334482	–		○
	25,6	4	4,2	PTFE B602/FKM	PT 1	532198	–		○
	25,6	4	4,2	PTFE B602/NBR	PT 1	24339869	–		○
	26	6	5	A505	LBH	CL0011-C0	–	○	
	26	6	5	F357	LBH	CL0011-C6	–	○	
	26	6	5	U593	LBI	FQ0013-C0	–	○	
	26	8	4	90 NBR 109	P 8	24224432 40422307	IP SP		● ●

d [mm]	D [mm]	H [mm]	L [mm]	Material	Design	Part No.	PU ¹⁾	US	EU
18	30	9	6	A795	DKB	AR0815-F5	-	○	
20	27,6	4	4,2	PTFE B602/NBR	PT 1	24269429	IP		●
	27,6	4	4,2	PTFE GM201/NBR	PT 1	24339980	-		○
	27,6	4	4,2	PTFE B602/FKM	PT 1	533331	-		○
	28	6	5	A505	LBH	CL0017-C0	-	○	
	28	6	5	F357	LBH	CL0017-C4	-	○	
	28	6	5	U593	LBI	FG0014-C0	-	○	
	28	8	4	90 NBR 109	P 8	24224396 40422287	IP SP		● ●
	32	9	6	A795	DKB	AR0995-E1	-	○	
	32	9	6	U801	DKBI	FD0995-F0	-	○	
22	28	6	4	95 AU V142	PU 11	24314567 40422455 8057-314.567	IP SP		● ●
						-	○		
	28	6	4	94 AU 30000	PU 11	49334483	-		○
	29,6	4	4,2	PTFE B602/NBR	PT 1	24302484	-		○
	30	6	5	A505	LBH	CL0240-C0	-	○	
	30	6	5	F357	LBH	CL0240-C3	-	○	
	30	6	5	U593	LBI	FG0651-C0	-	○	
	30	7	4	94 AU 925	PRV 1	49012374 40422525	IP SP	○	● ●
	30	7	4	92 AU 21100	PRV 1	49024430	-		○
30	8	4	90 NBR 109	P 8	24224431 40422306	IP SP		● ●	
34	9	6	A795	DKB	AR1121-F5	-	○		
22,4	30,4	6	5	A505	LBH	CL0026-C3	-	○	
	30,4	6	5	F357	LBH	CL0026-C6	-	○	
	30,4	6	5	U593	LBI	FG0016-C0	-	○	
	34,4	9	6	A795	DKB	AR1203-F5	-	○	
24	31,6	4	4,2	PTFE B602/NBR	PT 1	24357382	-		○
25	31	6	4	95 AU V142	PU 11	49003027	IP	○	●
						-			
	32,6	4	4,2	PTFE B602/NBR	PT 1	24275331	IP		●
	32,6	4	4,2	PTFE B602/FKM	PT 1	24275423	-		○
	32,6	4	4,2	PTFE GM201/NBR	PT 1	24330459	IP		●
	33	6	5	A505	LBH	CL0031-C0	-	○	
	33	6	5	F357	LBH	CL0031-C2	-	○	
	33	6	5	U593	LBI	FG0018-C0	-	○	
	33	7	4	94 AU 925	PRV 1	49012375 40422526	IP SP	○	● ●
	33	7	4	92 AU 21100	PRV 1	49024400	IP		●
	33	7	4	94 AU 30000	PRV 1	49334320	-		○
	33	8	4	90 NBR 109	P 8	24224397 40422288	IP SP		● ●
	37	9	6	A795	DKB	AR1301-H5	-	○	
37	9	6	U801	DKBI	FD1301-E0	-	○		
37	9	6	U641	DKBI	FD1301-E3	-	○		
25,4	33	4	4,2	PTFE B602/NBR	PT 1	24360115	-		○
26	34	6	5	U593	LBI	FG0841-C0	-	○	
28	35,6	4	4,2	PTFE B602/NBR	PT 1	24275334	IP		●
	35,6	4	4,2	PTFE B602/FKM	PT 1	24275426	IP		●
	35,6	4	4,2	PTFE GM201/NBR	PT 1	525556	-		○
	36	6	5	A505	LBH	CL0042-C0	-	○	

d [mm]	D [mm]	H [mm]	L [mm]	Material	Design	Part No.	PU ¹⁾	US	EU
28	36	6	5	F357	LBH	CL0042-C4	-	○	
	36	6	5	U593	LBI	FG0023-C0	-	○	
	36	7	4	94 AU 925	PRW 1	528538 40422073	IP SP	○	● ●
	36	7	4	92 AU 21100	PRW 1	49024429	-		○
	36	7,5	5	95 AU V142	PU 11	24294432 40422407	IP SP		● ●
	36	7,5	5	94 AU 30000	PU 11	49334484	-		○
	36	8	4	90 NBR 109	P 8	24224430 40422305	IP SP		● ●
30	40	9	6	A795	DKB	AR1536-F5	-	○	
	37,6	4	4,2	PTFE B602/NBR	PT 1	24275338	IP		●
	37,6	4	4,2	PTFE B602/FKM	PT 1	24275430	-		○
	37,6	4	4,2	PTFE GM201/NBR	PT 1	49013957	IP		●
	38	6,5	6	A505	LBH	CL0050-C0	-	○	
	38	6,5	6	F357	LBH	CL0050-C3	-	○	
	38	6,5	6	U593	LBI	FG0025-C1	-	○	
	38	7	4	94 AU 925	PRW 1	530000 40422077	IP SP	○	● ●
	38	7	4	92 AU 21100	PRW 1	49032529 40422530	IP SP		● ●
	38	7	4	94 AU 30000	PRW 1	49334321	-		○
	38	7,5	5	95 AU V142	PU 11	49003028	IP	○	●
	38	8	4	90 NBR 109	P 8	24224398 40422289	IP SP		● ●
	42	9	6	A795	DKB	AR1664-F5	-	○	
	42	9	6	U801	DKBI	FD1664-E0	-	○	
42	9	6	U641	DKBI	FD1664-E3	-	○		
31,5	39,5	6,5	6	A505	LBH	CL0054-C0	-	○	
	39,5	6,5	6	F357	LBH	CL0054-C3	-	○	
	39,5	6,5	6	U593	LBI	FG0027-C0	-	○	
	44	10	7	A795	DKB	AR1803-G5	-	○	
32	39,6	4	4,2	PTFE B602/NBR	PT 1	24269656	IP		●
	39,6	4	4,2	PTFE B602/FKM	PT 1	24275434	-		○
	39,6	4	4,2	PTFE GM201/FKM	PT 1	24351724	-		○
	39,6	4	4,2	PTFE GM201/NBR	PT 1	24374978	-		○
	40	6,5	6	A505	LBH	CL0363-C0	-	○	
	40	6,5	6	F357	LBH	CL0363-C3	-	○	
	40	6,5	6	U593	LBI	FG0568-C1	-	○	
	40	7	4	94 AU 925	PRW 1	531403 40422088	IP SP	○	● ●
	40	7	4	92 AU 21100	PRW 1	49024428	-		○
	40	7	4	94 AU 30000	PRW 1	49334322	-		○
	40	8	4	90 NBR 109	P 8	24224429 40422304	IP SP		● ●
	44	10	7	A795	DKB	AR1870-F5	-	○	
	44	10	7	U801	DKBI	FD1870-E0	-	○	
44	10	7	U641	DKBI	FD1870-E3	-	○		
34	42	6,5	6	U593	LBI	FG0285-C0	-	○	
35	42,6	4	4,2	PTFE B602/NBR	PT 1	24275347	IP		●
	42,6	4	4,2	PTFE B602/FKM	PT 1	24275439	IP		●
	43	6,5	6	A505	LBH	CL0066-C1	-	○	
	43	6,5	6	F357	LBH	CL0066-C4	-	○	

d [mm]	D [mm]	H [mm]	L [mm]	Material	Design	Part No.	PU ¹⁾	US	EU
	43	6,5	6	U593	LBH	FG0031-C1	-	○	
	43	7	4	94 AU 925	PRV 1	531022 40422086	IP SP	○	● ●
	43	7	4	92 AU 21100	PRV 1	49024572 40422529	IP SP		● ●
35	43	7	4	94 AU 30000	PRV 1	49334323	-		○
	43	7,5	5	95 AU V142	PU 11	24360972	IP		●
	43	8	4	90 NBR 109	P 8	24224399 40422290	IP SP		● ●
	47	10	7	A795	DKB	AR2041-E5	-	○	
	47	10	7	U801	DKBI	FD2041-E1	-	○	
	47	10	7	U641	DKBI	FD2041-E4	-	○	
35,5	43,5	6,5	6	A505	LBH	CL0072-C0	-	○	
	43,5	6,5	6	F357	LBH	CL0072-C4	-	○	
	43,5	6,5	6	U593	LBH	FG0034-C0	-	○	
	47,5	10	7	A795	DKB	AR2149-F5	-	○	
35,7	43,3	4	4,2	PTFE B602/NBR	PT 1	24362324	-		○
36	43,6	4	4,2	PTFE B602/NBR	PT 1	24275352	IP		●
	43,6	4	4,2	PTFE B602/FKM	PT 1	24275444	-		○
	43,6	4	4,2	PTFE GM201/NBR	PT 1	49016649	IP		●
	44	6,5	6	A505	LBH	CL0335-C1	-	○	
	44	7	4	94 AU 925	PRV 1	531411 40422089	IP SP		● ●
	44	7	4	92 AU 21100	PRV 1	49046345	-		○
	44	7	4	94 AU 30000	PRV 1	49334324	-		○
	44	7,5	5	95 AU V142	PU 11	24311422 40422425	IP SP		● ●
	44	7,5	5	94 AU 30000	PU 11	49334485	-		○
	44	8	4	90 NBR 109	P 8	24224428 40422303 2516-224.428	IP SP -	○	● ●
37	48	10	7	A795	DKB	BR1418-E5	-	○	
	45	7	4	94 AU 925	PRV 1	49012106	-		○
	45	7	4	92 AU 21100	PRV 1	49024431	-		○
38	45,6	4	4,2	PTFE B602/NBR	PT 1	24275332	-		○
	45,6	4	4,2	PTFE B602/FKM	PT 1	24275424	-		○
	46	6,5	6	U593	LBH	FG0281-C1	-	○	
	46	7	4	94 AU 925	PRV 1	49005191 40422521	IP SP	○	● ●
	48	6,5	6	A505	LBH	CL0077-C2	-	○	
	48	6,5	6	F357	LBH	CL0077-C4	-	○	
	48	6,5	6	U593	LBH	FG0035-C1	-	○	
40	48	7	4	94 AU 925	PRV 1	531116 40422087	IP SP	○	● ●
	48	7	4	92 AU 21100	PRV 1	49024427	-		○
	48	7	4	94 AU 30000	PRV 1	49334325	-		○
	48	7,5	5	95 AU V142	PU 11	24360973	IP	○	●
	48	8	4	90 NBR 109	P 8	24224400 40422291	IP SP		● ●
	48,8	6	6,3	PTFE B602/NBR	PT 1	24261061	IP		●
	48,8	6	6,3	PTFE B602/FKM	PT 1	24275427	-		○
	48,8	6	6,3	PTFE GM201/NBR	PT 1	49023486	IP		●
	52	10	7	A795	DKB	AR2342-E5	-	○	
	52	10	7	U801	DKBI	FD2342-F0	-	○	

d [mm]	D [mm]	H [mm]	L [mm]	Material	Design	Part No.	PU ¹⁾	US	EU
40	52	10	7	U641	DKBI	FD2342-F3	-	○	
41	49,8	6	6,3	PTFE GM201/NBR	PT 1	24344869	-		○
	50	7	4	94 AU 925	PRV 1	49044911	-		○
42	50	8	4	90 NBR 109	P 8	24224427 40422302	IP SP		● ●
	50,8	6	6,3	PTFE B602/NBR	PT 1	24275339	IP		●
	50,8	6	6,3	PTFE B602/FKM	PT 1	24275431	-		○
43	51	7	4	92 AU 21100	PRV 1	49023978	-		○
	51	7	4	94 AU 925	PRV 1	49023979	IP	○	●
43,5	52,3	6	6,3	PTFE B602/NBR	PT 1	24380003	-		○
45	53	6,5	6	A505	LBH	CL0085-C0	-	○	
	53	6,5	6	F357	LBH	CL0085-C4	-	○	
	53	6,5	6	U593	LBH	FG0039-C1	-	○	
	53	7	4	94 AU 925	PRV 1	531412 40422090	IP SP		● ●
	53	7	4	94 AU 30000	PRV 1	49334326	-		○
	53	7,5	5	95 AU V142	PU 11	24338684 40422467	IP SP		● ●
	53	7,5	5	94 AU 30000	PU 11	49334486	-		○
	53	7,8	5	94 AU 925	PRV 1	49031586	IP		●
	53	8	4	90 NBR 109	P 8	24217239 40422209	IP SP		● ●
	53,8	6	6,3	PTFE B602/NBR	PT 1	24275341	IP		●
	53,8	6	6,3	PTFE B602/FKM	PT 1	24275433	IP		●
	53,8	6	6,3	PTFE GM201/FKM	PT 1	24351723	-		○
	53,8	6	6,3	PTFE GM201/NBR	PT 1	49016648	IP		●
	57	10	7	A795	DKB	AR2633-G5	-	○	
	57	10	7	U801	DKBI	FD2633-G0	-	○	
57	10	7	U641	DKBI	FD2633-G3	-	○		
48	56	6,5	6	U593	LBH	FG0272-C0	-	○	
	58	9	6,3	94 AU 925	PRV 1	526679 40422072	IP SP	○	● ●
50	58	6,5	6	A505	LBH	CL0087-C3	-	○	
	58	6,5	6	F357	LBH	CL0087-C5	-	○	
	58	6,5	6	U593	LBH	FG0041-C0	-	○	
	58	7	4	94 AU 925	PRV 1	528607 40422074	IP SP	○	● ●
	58	7	4	92 AU 21100	PRV 1	49016788	-		○
	58	7	4	94 AU 30000	PRV 1	49334327	-		○
	58	7,5	5	95 AU V142	PU 11	49003029	IP	○	●
	58	8	4	90 NBR 109	P 8	24197635 40422206	IP SP		● ●
	58,8	6	6,3	PTFE B602/NBR	PT 1	24275345	IP		●
	58,8	6	6,3	PTFE B602/FKM	PT 1	24275437	-		○
	58,8	6	6,3	PTFE GM201/FKM	PT 1	24351716	-		○
	58,8	6	6,3	PTFE GM201/NBR	PT 1	49004617	IP		●
	60	9	6,3	94 AU 925	PRV 1	49040950 40422531	IP SP	○	● ●
	60	9	6,3	92 AU 21100	PRV 1	49047210	IP		●
	60	9	6,3	94 AU 30000	PRV 1	49334328	-		○
62	10	7	A795	DKB	AR2831-F5	-	○		
62	10	7	U801	DKBI	FD2831-E0	-	○		
62	10	7	U641	DKBI	FD2831-E3	-	○		

d [mm]	D [mm]	H [mm]	L [mm]	Material	Design	Part No.	PU ¹⁾	US	EU
53	61	6,5	6	A505	LBH	CL0100-C0	-	○	
	61	6,5	6	F357	LBH	CL0100-C2	-	○	
55	63	6,5	6	A505	LBH	CL0104-C0	-	○	
	63	6,5	6	F357	LBH	CL0104-C2	-	○	
	63	6,5	6	U593	LBI	FG0045-C1	-	○	
	63	7	4	94 AU 925	PRW 1	528815 40422075	IP SP	○	● ●
	63	7	4	94 AU 30000	PRW 1	49334329	-		○
	63	8	4	90 NBR 109	P 8	24224402 40422292	IP SP		● ●
	63,8	6	6,3	PTFE B602/NBR	PT 1	24300395	IP		●
	63,8	6	6,3	PTFE GM201/NBR	PT 1	49014632	IP		●
	65	8,5	6	95 AU V142	PU 11	49000803	-		○
	65	9	6,3	94 AU 925	PRW 1	49025646	-		○
	65	9	6,3	92 AU 21100	PRW 1	49025648	-		○
	69	11	8	A795	DKB	AR3033-F5	-	○	
	69	11	8	U801	DKBI	FD3033-E1	-	○	
	69	11	8	U641	DKBI	FD3033-E5	-	○	
56	64	6,5	6	A505	LBH	CL0105-C1	-	○	
	64	6,5	6	F357	LBH	CL0105-C4	-	○	
	64	6,5	6	U593	LBI	FG0048-C1	-	○	
	64	8	4	90 NBR 109	P 8	24224425 40422301	IP SP		● ●
	64,8	6	6,3	PTFE B602/NBR	PT 1	24275351	IP		●
	64,8	6	6,3	PTFE B602/FKM	PT 1	24275443	-		○
	64,8	6	6,3	PTFE GM201/FKM	PT 1	24332544	-		○
	64,8	6	6,3	PTFE GM201/NBR	PT 1	24371778	-		○
	66	8,5	6	95 AU V142	PU 11	24314566 40422454	IP SP		● ●
	66	8,5	6	94 AU 30000	PU 11	49334487	-		○
66	9	6,3	94 AU 925	PRW 1	49063593	IP		●	
70	11	8	A795	DKB	AR3089-G5	-	○		
58	66	6,5	6	U593	LBI	FG0286-C0	-	○	
60	68	6,5	6	A505	LBH	CL0107-C0	-	○	
	68	6,5	6	F357	LBH	CL0107-C2	-	○	
	68	6,5	6	U593	LBI	FG0049-C1	-	○	
	68	8	4	90 NBR 109	P 8	24224403 40422293	IP SP		● ●
	68,8	6	6,3	PTFE GM201/NBR	PT 1	531996	IP		●
	68,8	6	6,3	PTFE B602/NBR	PT 1	24269451	IP		●
	68,8	6	6,3	PTFE B602/FKM	PT 1	24275425	IP		●
	68,8	6	6,3	PTFE GM201/FKM	PT 1	24351722	-		○
	70	8,5	6	95 AU V142	PU 11	49003030	IP	○	●
	70	9	6,3	94 AU 925	PRW 1	49024554 40422528	IP SP	○	● ●
	70	9	6,3	92 AU 21100	PRW 1	49024553	IP		●
	70	9	6,3	94 AU 30000	PRW 1	49334330	-		○
	74	11	8	A795	DKB	AR3187-G5	-	○	
74	11	8	U801	DKBI	FD3187-E0	-	○		
74	11	8	U641	DKBI	FD3187-E3	-	○		
63	71	6,5	6	A505	LBH	CL0109-C1	-	○	
	71	6,5	6	F357	LBH	CL0109-C3	-	○	

d [mm]	D [mm]	H [mm]	L [mm]	Material	Design	Part No.	PU ¹⁾	US	EU
	71	6,5	6	U593	LB1	FG0054-C0	-	○	
	71	8	4	90 NBR 109	P 8	24224424 40422300	IP SP		● ●
63	71,8	6	6,3	PTFE B602/NBR	PT 1	24275336	IP		●
	71,8	6	6,3	PTFE B602/FKM	PT 1	24275428	-		○
	71,8	6	6,3	PTFE GM201/NBR	PT 1	49002145	IP		●
	73	9	6,3	94 AU 925	PRV 1	49042859	-		○
	77	11	8	A795	DKB	AR3313-F5	-	○	
63,5	72,3	6	6,3	PTFE GM201/NBR	PT 1	526133	-		○
	69	11	8	U641	DKBI	FD3381-E3	-	○	
	73	6,5	6	A505	LBH	CL0115-C0	-	○	
	73	6,5	6	F357	LBH	CL0115-C2	-	○	
	73	6,5	6	U593	LB1	FG0057-C1	-	○	
	73	7	4	94 AU 925	PRV 1	529092	-		○
65	73	8	4	90 NBR 109	P 8	24224404 40422294	IP SP		● ●
	73,8	6	6,3	PTFE B602/NBR	PT 1	24275348	IP		●
	73,8	6	6,3	PTFE B602/FKM	PT 1	24275440	-		○
	73,8	6	6,3	PTFE GM201/NBR	PT 1	24380154	-		○
	73,8	6	6,3	PTFE GM201/FKM	PT 1	24350541	IP		●
	75	8,5	6	95 AU V142	PU 11	49000804	IP	○	●
	79	11	8	A795	DKB	AR3381-F5	-	○	
	79	11	8	U801	DKBI	FD3381-E0	-	○	
66,68	75,4	6	6,3	PTFE B602/NBR	PT 1	24368072	-		○
67	75	6,5	6	A505	LBH	CL0118-C1	-	○	
	75	6,5	6	F357	LBH	CL0118-C2	-	○	
68	76,8	6	6,3	PTFE GM201/NBR	PT 1	49024834	-		○
	78	8	4	90 NBR 109	P 8	24224423 40422299	IP SP		● ●
	80	8	7	A505	LBH	CL0121-C0	-	○	
	80	8	7	F357	LBH	CL0121-C3	-	○	
	80	8	7	U593	LB1	FG0059-C0	-	○	
	80	8,5	6	95 AU V142	PU 11	24338685 40422468	IP SP	○	● ●
	80	8,5	6	94 AU 30000	PU 11	49334488	-		○
70	80	9	6,3	94 AU 925	PRV 1	49022349 40422527	IP SP	○	● ●
	80	9	6,3	92 AU 21100	PRV 1	49024378	-		○
	80	9	6,3	94 AU 30000	PRV 1	49334331	-		○
	82,2	7,7	8,1	PTFE B602/NBR	PT 1	24275343	IP		●
	82,2	7,7	8,1	PTFE B602/FKM	PT 1	24275435	IP		●
	82,2	7,7	8,1	PTFE GM201/FKM	PT 1	24351734	IP		●
	82,2	7,7	8,1	PTFE GM201/NBR	PT 1	24371776	IP		●
	84	11	8	A795	DKB	AR3493-F5	-	○	
	84	11	8	U801	DKBI	FD3493-E0	-	○	
	84	11	8	U641	DKBI	FD3493-E2	-	○	
71	81	8	7	A505	LBH	CL0125-C0	-	○	
	81	8	7	F357	LBH	CL0125-C2	-	○	
	81	8	7	U593	LB1	FG0062-C0	-	○	
74	86,2	7,7	8,1	PTFE GM201/NBR	PT 1	49023043	-		○
75	83	8	4	90 NBR 109	P 8	24224405 40422295	IP SP		● ●

d [mm]	D [mm]	H [mm]	L [mm]	Material	Design	Part No.	PU ¹⁾	US	EU
	85	8	7	A505	LBH	CL0127-C0	-	○	
	85	8	7	F357	LBH	CL0127-C2	-	○	
	85	8	7	U593	LBH	FG0063-C0	-	○	
	85	8,5	6	95 AU V142	PU 11	49000806	IP	○	●
	85	9	6,3	94 AU 925	PRV 1	49040948	IP		●
75	87,2	7,7	8,1	PTFE B602/NBR	PT 1	24275346	IP		●
	87,2	7,7	8,1	PTFE B602/FKM	PT 1	24275438	-		○
	87,2	7,7	8,1	PTFE GM201/FKM	PT 1	24339905	-		○
	87,2	7,7	8,1	PTFE GM201/NBR	PT 1	49018473	IP		●
	89	11	8	A795	DKB	AR3596-G5	-	○	
	89	11	8	U801	DKBI	FD3596-E0	-	○	
	89	11	8	U641	DKBI	FD3596-E1	-	○	
76,2	88,4	7,7	8,1	PTFE B602/NBR	PT 1	24342993	-		○
	87	9	6,3	94 AU 925	PRV 1	49005392	-		○
77	87	9	6,3	92 AU 21100	PRV 1	49024377	-		○
	89,2	7,7	8,1	PTFE GM201/NBR	PT 1	528707	-		○
	88	8	4	90 NBR 109	P 8	24224422 40422298	IP SP		● ●
	90	8	7	A505	LBH	CL0138-C1	-	○	
	90	8	7	F357	LBH	CL0138-C3	-	○	
	90	8	7	U593	LBH	FG0064-C0	-	○	
	90	8,5	6	95 AU V142	PU 11	24369056	IP	○	●
80	90	9	6,3	94 AU 925	PRV 1	49005193	-		○
	92,2	7,7	8,1	PTFE B602/NBR	PT 1	24275350	IP		●
	92,2	7,7	8,1	PTFE B602/FKM	PT 1	24275442	IP		●
	92,2	7,7	8,1	PTFE GM201/FKM	PT 1	24351705	-		○
	92,2	7,7	8,1	PTFE GM201/NBR	PT 1	49016404	IP		●
	94	11	8	A795	DKB	AR3720-H5	-	○	
	94	12	8	U801	DKBI	FD3720-E0	-	○	
	94	12	8	U641	DKBI	FD3720-N0	-	○	
81	93,2	7,7	8,1	PTFE B602/NBR	PT 1	24369224	-		○
82	94,2	7,7	8,1	PTFE B602/NBR	PT 1	24333837	-		○
	93	8	4	90 NBR 109	P 8	24224406 40422296	IP SP		● ●
	95	8	7	A505	LBH	CL0142-C0	-	○	
	95	8	7	F357	LBH	CL0142-C3	-	○	
	95	8	7	U593	LBH	FG0066-C0	-	○	
	95	9	6,3	94 AU 925	PRV 1	49005391 40422523	IP SP	○	● ●
85	95	9	6,3	94 AU 30000	PRV 1	49334332	-		○
	97,2	7,7	8,1	PTFE B602/NBR	PT 1	24275337	IP		●
	97,2	7,7	8,1	PTFE B602/FKM	PT 1	24275429	-		○
	97,2	7,7	8,1	PTFE GM201/NBR	PT 1	24380155	-		○
	99	11	8	A795	DKB	AR3828-F5	-	○	
	99	11	8	U801	DKBI	FD3828-G0	-	○	
	99	11	8	U641	DKBI	FD3828-G1	-	○	
88,9	101,1	7,7	8,1	PTFE B602/NBR	PT 1	24352275	-		○
	101,1	7,7	8,1	PTFE B602/FKM	PT 1	24359948	-		○
	14	11	8	U641	DKBI	FD3913-E1	-	○	
90	98	8	4	90 NBR 109	P 8	24224032 40422286	IP SP		● ●
	100	8	7	A505	LBH	CL0149-C0	-	○	

d [mm]	D [mm]	H [mm]	L [mm]	Material	Design	Part No.	PU ¹⁾	US	EU
	100	8	7	F357	LBH	CL0149-C4	-	○	
	100	8	7	U593	LBH	FG0070-C0	-	○	
	100	8,5	6	95 AU V142	PU 11	24338686 40422469	IP SP		● ●
	100	8,5	6	94 AU 30000	PU 11	49334489	-		○
90	100	9	6,3	94 AU 925	PRV 1	49040949	IP		●
	100	9	6,3	92 AU 21100	PRV 1	49327280	-		○
	102,2	7,7	8,1	PTFE B602/NBR	PT 1	24275340	IP		●
	102,2	7,7	8,1	PTFE B602/FKM	PT 1	24275432	IP		●
	102,2	7,7	8,1	PTFE GM201/FKM	PT 1	24351735	-		○
	104	11	8	A795	DKB	AR3913-E0	-	○	
	104	11	8	U801	DKBI	FD3913-E0	-	○	
92	102	9	6,3	94 AU 925	PRV 1	49005192	IP		●
	105	8	7	A505	LBH	CL0152-C0	-	○	
	105	8	7	F357	LBH	CL0152-C3	-	○	
	105	8	7	U593	LBH	FG0071-C0	-	○	
	107,2	7,7	8,1	PTFE B602/NBR	PT 1	24275344	-		○
95	107,2	7,7	8,1	PTFE B602/FKM	PT 1	24275436	-		○
	107,2	7,7	8,1	PTFE GM201/NBR	PT 1	24379210	IP		●
	109	11	8	A795	DKB	AR3976-G5	-	○	
	109	11	8	U801	DKBI	FD3976-E0	-	○	
	109	11	8	U641	DKBI	FD3976-E3	-	○	
	108	8	4	90 NBR 109	P 8	24224407 40422297	IP SP		● ●
	110	8	7	A505	LBH	CL0154-C2	-	○	
	110	8	7	F357	LBH	CL0154-C4	-	○	
	110	8	7	U593	LBH	FG0072-C0	-	○	
	112,2	7,7	8,1	PTFE B602/NBR	PT 1	24275349	IP		●
	112,2	7,7	8,1	PTFE B602/FKM	PT 1	24275441	IP		●
100	112,2	7,7	8,1	PTFE GM201/FKM	PT 1	24354911	-		○
	112,2	7,7	8,1	PTFE GM201/NBR	PT 1	24380032	IP		●
	114	11	8	A795	DKB	AR4046-G5	-	○	
	114	11	8	U801	DKBI	FD4046-E1	-	○	
	114	11	8	U641	DKBI	FD4046-E2	-	○	
	115	13	9,5	94 AU 925	PRV 1	49063603	IP		●
	122,2	13,5	6,3	PTFE B602/NBR	PT 2	24359838	IP		●
	122,2	13,5	6,3	PTFE B602/FKM	PT 2	49025565	-		○
101,6	123,8	13,5	6,3	PTFE B602/FKM	PT 2	24367430	-		○
	115	8	7	A505	LBH	CL0476-C0	-	○	
	115	8	7	U593	LBH	FG0075-C0	-	○	
	117	11	5,5	90 NBR 109	P 8	24224420	IP		●
	117,2	7,7	8,1	PTFE GM201/FKM	PT 1	24350943	-		○
105	117,2	7,7	8,1	PTFE GM201/NBR	PT 1	24380095	IP		●
	117,2	7,7	8,1	PTFE B602/NBR	PT 1	24275353	IP		●
	117,2	7,7	8,1	PTFE B602/FKM	PT 1	24275445	-		○
	121	12	9	A795	DKB	AR4142-F5	-	○	
	121	12	9	U801	DKBI	FD6722-E0	-	○	
	121	12	9	U641	DKBI	FD6722-E1	-	○	
106	116	8	7	A505	LBH	CL0162-C0	-	○	
107	119,2	7,7	8,1	PTFE B602/NBR	PT 1	24264451	-		○
110	120	8	7	A505	LBH	CL0448-C0	-	○	

d [mm]	D [mm]	H [mm]	L [mm]	Material	Design	Part No.	PU ¹⁾	US	EU
	120	8	7	F357	LBH	CL0448-C2	-	○	
	120	8	7	U593	LBH	FG0079-C1	-	○	
	122	11	5,5	90 NBR B283	P 8	24224408	IP		●
	122,2	7,7	8,1	PTFE B602/NBR	PT 1	24275356	IP		●
	122,2	7,7	8,1	PTFE B602/FKM	PT 1	24275448	-		○
	122,2	7,7	8,1	PTFE GM201/FKM	PT 1	24351715	-		○
	122,2	7,7	8,1	PTFE GM201/NBR	PT 1	24380092	IP		●
110	125	12	8,5	95 AU V142	PU 11	24338687 40422470	IP SP		● ●
	125	12	8,5	94 AU 30000	PU 11	49334490	-		○
	126	12	9	A795	DKB	AR4196-F5	-	○	
	126	12	9	U801	DKBI	FD4196-E0	-	○	
	126	12	9	U641	DKBI	FD4196-E3	-	○	
	132,2	13,5	6,3	PTFE B602/FKM	PT 2	24360999	-		○
	132,2	13,5	6,3	PTFE B602/NBR	PT 2	24361474	-		○
111,1	123,3	7,7	8,1	PTFE B602/FKM	PT 1	24375982	-		○
	122	8	7	A505	LBH	CL0166-C2	-	○	
112	122	8	7	F357	LBH	CL0166-C3	-	○	
	122	8	7	U593	LBH	FG0082-C0	-	○	
	128	12	9	A795	DKB	AR4232-F5	-	○	
112,8	125	7,7	8,1	PTFE B602/NBR	PT 1	24362325	-		○
	125	8	7	A505	LBH	CL0478-C0	-	○	
	127,2	7,7	8,1	PTFE B602/NBR	PT 1	24275360	-		○
	127,2	7,7	8,1	PTFE B602/FKM	PT 1	24275452	-		○
115	127,2	7,7	8,1	PTFE GM201/FKM	PT 1	24359810	-		○
	127,2	7,7	8,1	PTFE GM201/NBR	PT 1	49040461	IP		●
	130	13	9,5	94 AU 925	PRV 1	49063602	IP		●
	131	12	9	U801	DKBI	FD4272-I0	-	○	
	131	12	9	U641	DKBI	FD4272-I1	-	○	
118	128	8	7	A505	LBH	CL0466-C0	-	○	
	132	11	5,5	90 NBR 109	P 8	24224409	IP		●
	132,2	7,7	8,1	PTFE B602/NBR	PT 1	24275364	IP		●
	132,2	7,7	8,1	PTFE B602/FKM	PT 1	24275456	-		○
	132,2	7,7	8,1	PTFE GM201/FKM	PT 1	24351736	-		○
120	132,2	7,7	8,1	PTFE GM201/NBR	PT 1	49012837	IP		●
	133	9,5	8	A505	LBH	CL0245-C1	-	○	
	136	12	9	A795	DKB	AR4326-E5	-	○	
	136	12	9	U801	DKBI	FD4326-E0	-	○	
	136	12	9	U641	DKBI	FD4326-E1	-	○	
	142,2	13,5	6,3	PTFE B602/NBR	PT 2	24357224	-		○
120,5	132,7	7,7	8,1	PTFE B602/NBR	PT 1	24363302	-		○
	137	11	5,5	90 NBR 109	P 8	24224031	IP		●
	137,2	7,7	8,1	PTFE B602/NBR	PT 1	24275365	IP		●
	137,2	7,7	8,1	PTFE B602/FKM	PT 1	24275461	IP		●
	137,2	7,7	8,1	PTFE GM201/FKM	PT 1	24352301	-		○
125	137,2	7,7	8,1	PTFE GM201/NBR	PT 1	24380156	IP		●
	138	9,5	8	A505	LBH	CL0171-C0	-	○	
	138	9,5	8	F357	LBH	CL0171-C3	-	○	
	138	9,5	8	U593	LBH	FG0091-C0	-	○	
	140	13	9,5	94 AU 925	PRV 1	49042860	IP		●

d [mm]	D [mm]	H [mm]	L [mm]	Material	Design	Part No.	PU ¹⁾	US	EU
125	141	12	9	A795	DKB	AR4393-F5	-	○	
	147,2	13,5	6,3	PTFE B602/NBR	PT 2	24373115	-		○
	147,2	13,5	6,3	PTFE B602/FKM	PT 2	49024812	-		○
127	139,2	7,7	8,1	PTFE B602/FKM	PT 1	24363335	-		○
130	142	11	5,5	90 NBR 109	P 8	24224410	IP		●
	142,2	7,7	8,1	PTFE B602/NBR	PT 1	24275374	IP		●
	142,2	7,7	8,1	PTFE B602/FKM	PT 1	24275466	-		○
	142,2	7,7	8,1	PTFE GM201/FKM	PT 1	24341216	-		○
	142,2	7,7	8,1	PTFE GM201/NBR	PT 1	49023823	IP		●
	146	12	9	U801	DKBI	FD4438-F0	-	○	
	146	12	9	U641	DKBI	FD4438-F3	-	○	
	152,2	13,5	6,3	PTFE B602/FKM	PT 2	24358280	-		○
132	152,2	13,5	6,3	PTFE B602/NBR	PT 2	24361475	-		○
	144,2	7,7	8,1	PTFE B602/NBR	PT 1	24347997	-		○
	145	9,5	8	A505	LBH	CL0174-C0	-	○	
133,35	145,5	7,7	8,1	PTFE B602/NBR	PT 1	24362641	-		○
135	147,2	7,7	8,1	PTFE GM201/FKM	PT 1	24380767	-		○
	147,2	7,7	8,1	PTFE B602/FKM	PT 1	24275333	-		○
	147,2	7,7	8,1	PTFE B602/NBR	PT 1	24275354	-		○
139,7	161,9	13,5	6,3	PTFE B602/NBR	PT 2	24361457	-		○
140	152	11	5,5	90 NBR 109	P 8	24224411	IP		●
	153	9,5	8	A505	LBH	CL0179-C1	-	○	
	153	9,5	8	F357	LBH	CL0179-C4	-	○	
	153	9,5	8	U593	LBH	FG0097-C0	-	○	
	155	12	8,5	95 AU V142	PU 11	24348685 40422477	IP SP		● ●
	156	11	11,5	PTFE B602/NBR	PT 1	24268086	-		○
	156	11	11,5	PTFE B602/FKM	PT 1	24275449	IP		●
	156	11	11,5	PTFE GM201/FKM	PT 1	24350944	-		○
	156	11	11,5	PTFE GM201/NBR	PT 1	49004558	IP		●
	160	14	10	A795	DKB	AR4533-G5	-	○	
	160	14	10	U801	DKBI	FD4533-E0	-	○	
	160	14	10	U641	DKBI	FD4533-E3	-	○	
	162,2	13,5	6,3	PTFE B602/FKM	PT 2	529583	-		○
	162,2	13,5	6,3	PTFE B602/NBR	PT 2	24344542	-		○
145	158	9,5	8	A505	LBH	CL0182-C0	-	○	
	158	9,5	8	F357	LBH	CL0182-C1	-	○	
	161	11	11,5	PTFE GM201/NBR	PT 1	24380702	IP		●
	161	11	11,5	PTFE B602/NBR	PT 1	24314584	-		○
	165	14	10	A795	DKB	AR4578-E5	-	○	
150	162	11	5,5	90 NBR 109	P 8	24224416	IP		●
	163	9,5	8	A505	LBH	CL0185-C0	-	○	
	163	9,5	8	U593	LBH	FG0101-C0	-	○	
	165	12	8,5	95 AU V142	PU 11	529428	-		○
	166	11	11,5	PTFE B602/NBR	PT 1	24275361	IP		●
	166	11	11,5	PTFE B602/FKM	PT 1	24275453	-		○
	166	11	11,5	PTFE GM201/FKM	PT 1	24339307	-		○
	166	11	11,5	PTFE GM201/NBR	PT 1	49005139	IP		●
	170	14	10	A795	DKB	AR4615-E5	-	○	
	172,2	13,5	6,3	PTFE B602/FKM	PT 2	24357793	-		○

d [mm]	D [mm]	H [mm]	L [mm]	Material	Design	Part No.	PU ¹⁾	US	EU
150	172,2	13,5	6,3	PTFE B602/NBR	PT 2	24360778	-		○
152,4	168,4	11	11,5	PTFE B602/NBR	PT 1	24361506	-		○
155	168	9,5	8	A505	LBH	CL0486-C0	-	○	
	171	11	11,5	PTFE GM201/NBR	PT 1	24380703	-		○
	171	11	11,5	PTFE B602/NBR	PT 1	24331782	-		○
	175	14	10	A795	DKB	AR4663-E5	-	○	
159,6	175,6	11	11,5	PTFE B602/NBR	PT 1	24362326	-		○
160	172	11	5,5	90 NBR 109	P 8	24224412	IP		●
	173	9,5	8	A505	LBH	CL0188-C1	-	○	
	173	9,5	8	F357	LBH	CL0188-C3	-	○	
	173	9,5	8	U593	LBH	FG0105-C2	-	○	
	174	9,5	8	A505	LBH	CL0487-C0	-	○	
	175	13	9,5	94 AU 925	PRV 1	49062320	IP		●
	176	11	11,5	PTFE B602/FKM	PT 1	24275455	IP		●
	176	11	11,5	PTFE GM201/FKM	PT 1	24350945	-		○
	176	11	11,5	PTFE GM201/NBR	PT 1	49015836	IP		●
	176	11,5	11,5	PTFE B602/NBR	PT 1	24275363	-		○
	180	14	10	A795	DKB	AR4704-G5	-	○	
	182,2	13,5	6,3	PTFE B602/NBR	PT 2	24347042	-		○
	182,2	13,5	6,3	PTFE B602/FKM	PT 2	24348020	-		○
	165	178	9,5	8	A505	LBH	CL0190-C0	-	○
181		11	11,5	PTFE B602/NBR	PT 1	24334733	-		○
181		11	11,5	PTFE GM201/NBR	PT 1	49036298	-		○
182		11	5,5	90 NBR 109	P 8	24224415	IP		●
170	183	9,5	8	A505	LBH	CL0488-C0	-	○	
	185	12	8,5	95 AU V142	PU 11	24349427	-		○
	185	14	12	A505	LBH	CL0191-C0	-	○	
	186	11	11,5	PTFE B602/NBR	PT 1	24275367	IP		●
	186	11	11,5	PTFE B602/FKM	PT 1	24275459	-		○
	186	11	11,5	PTFE GM201/FKM	PT 1	24351743	-		○
	186	11	11,5	PTFE GM201/NBR	PT 1	24380704	IP		●
	190	14	10	A795	DKB	AR4785-E5	-	○	
	192,2	13,5	6,3	PTFE B602/NBR	PT 2	24344540	-		○
	192,2	13,5	6,3	PTFE B602/FKM	PT 2	24357223	-		○
175	188	9,5	8	A505	LBH	CL0193-C0	-	○	
	191	11	11,5	PTFE GM201/NBR	PT 1	24362382	IP		●
	191	11	11,5	PTFE B602/NBR	PT 1	24379250	-		○
	195	14	10	A795	DKB	AR4839-F5	-	○	
177,8	193,8	11	11,5	PTFE B602/NBR	PT 1	24362253	-		○
180	192	11	5,5	90 NBR B283	P 8	24224413	IP		●
	193	9,5	8	A505	LBH	CL0196-C1	-	○	
	193	9,5	8	F357	LBH	CL0196-C4	-	○	
	193	9,5	8	U593	LBH	FG0111-C0	-	○	
	194	9,5	8	A505	LBH	CL0489-C0	-	○	
	196	11	11,5	PTFE B602/NBR	PT 1	24275373	IP		●
	196	11	11,5	PTFE GM201/FKM	PT 1	24350946	-		○
	196	11	11,5	PTFE GM201/NBR	PT 1	531957	IP		●
	196	11,5	11,5	PTFE B602/FKM	PT 1	24275465	-		○
	202,2	13,5	6,3	PTFE B602/NBR	PT 2	24350643	IP		●
	202,2	13,5	6,3	PTFE B602/FKM	PT 2	24357393	-		○

d [mm]	D [mm]	H [mm]	L [mm]	Material	Design	Part No.	PU ¹⁾	US	EU
180	205	17	12	A795	DKB	AR4890-G5	-	○	
185	198	9,5	8	U593	IBI	FG0114-C0	-	○	
	203	9,5	8	A505	LBH	CL0490-C0	-	○	
	206	11	11,5	PTFE GM201/FKM	PT 1	24352303	-		○
190	206	11	11,5	PTFE B602/NBR	PT 1	24275355	-		○
	206	11	11,5	PTFE B602/FKM	PT 1	24275447	-		○
	212,2	13,5	6,3	PTFE B602/NBR	PT 2	24368087	-		○
195	211	11	11,5	PTFE GM201/NBR	PT 1	49023874	IP		●
195,4	211,4	11	11,5	PTFE B602/NBR	PT 1	24362327	-		○
	212	11	5,5	90 NBR 109	P 8	24224414	IP		●
	213	9,5	8	A505	LBH	CL0199-C1	-	○	
	213	9,5	8	F357	LBH	CL0199-C3	-	○	
	213	9,5	8	U593	IBI	FG0117-C0	-	○	
	216	11	11,5	PTFE B602/NBR	PT 1	24275358	IP		●
200	216	11	11,5	PTFE B602/FKM	PT 1	24275450	-		○
	216	11	11,5	PTFE GM201/FKM	PT 1	24351701	-		○
	216	11	11,5	PTFE GM201/NBR	PT 1	24342233	IP		●
	220	18	10,2	85 NBR B247	P 9	24212749	IP		●
	222,2	13,5	6,3	PTFE B602/NBR	PT 2	24353154	-		○
	225	17	12	A795	DKB	AR5048-G5	-	○	
205	218	9,5	8	A505	LBH	CL0446-C0	-	○	
	223	9,5	8	A505	LBH	CL0324-C1	-	○	
	223	9,5	8	U593	IBI	FG0120-C0	-	○	
	225	13	6,5	85 NBR B247	P 8	49017591	-		○
210	226	11	11,5	PTFE GM201/NBR	PT 1	24380705	IP		●
	226	11	11,5	PTFE B602/NBR	PT 1	24275370	-		○
	226	11	11,5	PTFE B602/FKM	PT 1	24275462	-		○
	230	18	10,2	85 NBR B247	P 9	24224920	IP		●
	232,2	13,5	6,3	PTFE B602/NBR	PT 2	24375895	-		○
215	231	11	11,5	PTFE B602/NBR	PT 1	24356093	-		○
	231	11	11,5	PTFE GM201/NBR	PT 1	49023875	IP		●
	235	13	6,5	85 NBR B247	P 8	24354797	IP		●
	236	11	11,5	PTFE B602/NBR	PT 1	24274581	IP		●
	236	11	11,5	PTFE B602/FKM	PT 1	24275457	-		○
220	236	11	11,5	PTFE GM201/FKM	PT 1	24351714	-		○
	236	11	11,5	PTFE GM201/NBR	PT 1	49002400	-		○
	236	11	11,5	PTFE C104/NBR	PT 1	49016408	IP		●
	240	18	10,2	85 NBR B247	P 9	24224959	IP		●
	242,2	13,5	6,3	PTFE B602/NBR	PT 2	24353169	-		○
224	237	9,5	8	A505	LBH	CL0204-C1	-	○	
	237	9,5	8	F357	LBH	CL0204-C2	-	○	
225	241	11	11,5	PTFE B602/NBR	PT 1	24373104	-		○
	250	17	12	A795	DKB	AR5245-F5	-	○	
228,6	244,6	11	11,5	PTFE B602/NBR	PT 1	24360114	-		○
	250,8	13,5	6,3	PTFE B602/NBR	PT 2	24360117	-		○
	246	11	11,5	PTFE B602/NBR	PT 1	24275368	IP		●
	246	11	11,5	PTFE B602/FKM	PT 1	24275460	-		○
230	246	11	11,5	PTFE GM201/FKM	PT 1	24351787	-		○
	246	11	11,5	PTFE GM201/NBR	PT 1	49004618	-		○
	250	18	10,2	85 NBR B247	P 9	24224931	-		○

d [mm]	D [mm]	H [mm]	L [mm]	Material	Design	Part No.	PU ¹⁾	US	EU
230	254,2	13,5	6,3	PTFE B602/NBR	PT 2	24355054	-		○
235	250	13	6,5	85 NBR B247	P 8	49017612	-		○
	251	11	11,5	PTFE B602/NBR	PT 1	24341611	-		○
240	255	13	6,5	85 NBR B247	P 8	24354798	-		○
	256	11	11,5	PTFE GM201/NBR	PT 1	533355	-		○
	256	11	11,5	PTFE B602/NBR	PT 1	24275372	IP		●
	256	11	11,5	PTFE B602/FKM	PT 1	24275464	-		○
	256	13	11	A505	LBH	CL0300-C0	-	○	
	260	18	10,2	85 NBR B247	P 9	24193882	IP		●
241,3	264,2	13,5	6,3	PTFE B602/NBR	PT 2	24356322	-		○
	257,3	11	11,5	PTFE B602/NBR	PT 1	24358306	-		○
245	261	11	11,5	PTFE B602/NBR	PT 1	24377708	-		○
250	265	11,5	10	U593	LBH	FG0131-C0	-	○	
	266	11	11,5	PTFE B602/NBR	PT 1	24275359	IP		●
	266	11	11,5	PTFE B602/FKM	PT 1	24275451	-		○
	266	11	11,5	PTFE GM201/NBR	PT 1	49009052	IP		●
	266	12	10	A505	LBH	CL0207-C0	-	○	
	266	13	11	A505	LBH	CL0267-C0	-	○	
	274,2	13,5	6,3	PTFE B602/NBR	PT 2	24371138	IP		●
	275	17	12	A795	DKB	AR5396-F5	-	○	
255	275	22,5	16	85 NBR B247	P 9	24175461	IP		●
	271	11	11,5	PTFE B602/NBR	PT 1	49002906	-		○
260	275	13	6,5	85 NBR B247	P 8	24354799	-		○
	275	13	6,5	90 NBR 109	P 8	49036054	IP		●
	276	9	9,5	PTFE GM201/NBR	PT 1	24375451	-		○
	276	11	11,5	PTFE B602/NBR	PT 1	24275362	-		○
	276	11	11,5	PTFE B602/FKM	PT 1	24275454	-		○
	284,2	13,5	6,3	PTFE B602/NBR	PT 2	24352166	-		○
	285	22,5	16	85 NBR B247	P 9	24224921	-		○
	281	11	11,5	PTFE GM201/FKM	PT 1	24351788	-		○
265	281	11	11,5	PTFE B602/NBR	PT 1	49009902	-		○
	281	11	11,5	PTFE GM201/NBR	PT 1	49023876	IP		●
270	286	11	11,5	PTFE B602/NBR	PT 1	24275366	IP		●
	286	11	11,5	PTFE B602/FKM	PT 1	24275458	-		○
	295	22,5	16	85 NBR B247	P 9	24213404	-		○
275	291	11	11,5	PTFE B602/NBR	PT 1	24314585	IP		●
	299,2	13,5	6,3	PTFE B602/NBR	PT 2	24351463	-		○
280	295	13	6,5	85 NBR B247	P 8	24354800	IP		●
	296	11	11,5	PTFE B602/NBR	PT 1	24275371	-		○
	296	11	11,5	PTFE B602/FKM	PT 1	24275463	-		○
	296	11	11,5	PTFE GM201/FKM	PT 1	24351702	-		○
	296	11	11,5	PTFE GM201/NBR	PT 1	49004005	IP		●
	296	12	10	A505	LBH	CL0212-C0	-	○	
	296	12	10	F357	LBH	CL0212-C2	-	○	
	304,2	13,5	6,3	PTFE B602/NBR	PT 2	24360995	-		○
285	305	22,5	16	85 NBR B247	P 9	24183892	IP		●
	301	11	11,5	PTFE B602/NBR	PT 1	49000403	-		○
290	306	11	11,5	PTFE B602/FKM	PT 1	24275467	-		○
	306	11	11,5	PTFE B602/NBR	PT 1	24275375	-		○
	314,2	13,5	6,3	PTFE B602/NBR	PT 2	49026457	-		○

d [mm]	D [mm]	H [mm]	L [mm]	Material	Design	Part No.	PU ¹⁾	US	EU
290	315	22,5	16	85 NBR B247	P 9	24224938	-		○
295	310	13	6,5	85 NBR B247	P 8	24355389	-		○
	319,2	13,5	6,3	PTFE B602/NBR	PT 2	24359585	-		○
300	315	13	6,5	85 NBR B247	P 8	24354801	-		○
	316	11	11,5	PTFE B602/NBR	PT 1	24275376	-		○
	316	11	11,5	PTFE B602/FKM	PT 1	24275468	-		○
	316	11	11,5	PTFE GM201/FKM	PT 1	24374010	-		○
	316	11	11,5	PTFE GM201/NBR	PT 1	49043075	IP		●
	325	22,5	16	85 NBR B247	P 9	24173146	IP		●
	333	18,4	8,1	PTFE B602/NBR	PT 2	24348115	-		○
308	333	18,4	8,1	PTFE B602/FKM	PT 2	24356968	-		○
	324	11	11,5	PTFE B602/NBR	PT 1	24300816	-		○
	325	13	6,5	85 NBR B247	P 8	24357280	-		○
310	326	11	11,5	PTFE B602/FKM	PT 1	24348310	-		○
	326	11	11,5	PTFE GM201/NBR	PT 1	49009461	IP		●
	326	11	11,5	PTFE B602/NBR	PT 1	24346809	-		○
	340	27	18	85 NBR B247	P 9	24224922	-		○
315	330	13	6,5	85 NBR B247	P 8	527673	-		○
	331	11	11,5	PTFE GM201/NBR	PT 1	49041473	-		○
	335	13	6,5	85 NBR B247	P 8	24355390	-		○
320	336	11	11,5	PTFE B602/NBR	PT 1	24296543	IP		●
	336	11	11,5	PTFE B602/FKM	PT 1	24342120	-		○
	336	11	11,5	PTFE GM201/FKM	PT 1	24351378	-		○
	336	11	11,5	PTFE GM201/NBR	PT 1	49010398	IP		●
	350	27	18	85 NBR B247	P 9	24224937	IP		●
	353	18,4	8,1	PTFE B602/NBR	PT 2	524609	-		○
	325	341	11	11,5	PTFE B602/NBR	PT 1	49003806	-	
346		11	11,5	PTFE GM201/NBR	PT 1	49004619	-		○
330	346	11	11,5	PTFE B602/NBR	PT 1	24334734	IP		●
	360	27	18	85 NBR B247	P 9	24146278	IP		●
330,2	363,2	18,4	8,1	PTFE B602/NBR	PT 2	24358312	-		○
335	350	13	6,5	85 NBR B247	P 8	49017614	-		○
	351	11	11,5	PTFE GM201/NBR	PT 1	49008975	IP		●
340	355	13	6,5	85 NBR B247	P 8	24354802	-		○
	356	11	11,5	PTFE B602/NBR	PT 1	24338668	-		○
	356	11	11,5	PTFE B602/FKM	PT 1	24345965	-		○
	356	11	11,5	PTFE GM201/FKM	PT 1	24351898	-		○
	370	27	18	85 NBR B247	P 9	24224930	-		○
	373	18,4	8,1	PTFE B602/NBR	PT 2	526102	-		○
	373	18,4	8,1	PTFE B602/FKM	PT 2	24358735	-		○
345	361	11	11,5	PTFE B602/NBR	PT 1	24367127	-		○
	365	13	6,5	85 NBR B247	P 8	24367045	-		○
350	366	11	11,5	PTFE B602/FKM	PT 1	24342121	-		○
	366	11	11,5	PTFE GM201/FKM	PT 1	24351703	-		○
	366	11	11,5	PTFE B602/NBR	PT 1	24338259	-		○
	380	27	18	85 NBR B247	P 9	24147758	IP		●
	383	18,4	8,1	PTFE B602/NBR	PT 2	24337999	-		○
	383	18,4	8,1	PTFE B602/FKM	PT 2	49027323	-		○
354	370	11	11,5	PTFE B602/NBR	PT 1	24370685	-		○
355	370	13	6,5	85 NBR B247	P 8	49017597	-		○







d [mm]	D [mm]	H [mm]	L [mm]	Material	Design	Part No.	PU ¹⁾	US	EU
355	371	11	11,5	PTFE B602/NBR	PT 1	24377706	-		○
	371	13	11	A505	LBH	CL0532-C0	-	○	
	375	14	11	A505	LBH	CL0301-C0	-	○	
360	375	13	6,5	85 NBR B247	P 8	24354803	-		○
	376	11	11,5	PTFE B602/NBR	PT 1	24289854	IP		●
	376	11	11,5	PTFE GM201/NBR	PT 1	49009462	IP		●
	376	11	11,5	PTFE B602/FKM	PT 1	49035735	-		○
	390	27	18	85 NBR B247	P 9	24224923	IP		●
	393	18,4	8,1	PTFE B602/NBR	PT 2	24331443	-		○
370	386	11	11,5	PTFE B602/NBR	PT 1	24342976	IP		●
	386	11	11,5	PTFE GM201/NBR	PT 1	49023877	IP		●
	400	27	18	85 NBR B247	P 9	24224929	-		○
	403	18,4	8,1	PTFE B602/NBR	PT 2	24344424	-		○
375	391	11	11,5	PTFE B602/NBR	PT 1	24346725	-		○
	391	11	11,5	PTFE GM201/NBR	PT 1	49026740	-		○
380	395	13	6,5	85 NBR B247	P 8	24354804	IP		●
	396	11	11,5	PTFE B602/NBR	PT 1	24343755	-		○
	396	11	11,5	PTFE GM201/NBR	PT 1	49019716	-		○
	410	27	18	85 NBR B247	P 9	24149422	IP		●
	413	18,4	8,1	PTFE B602/NBR	PT 2	24346896	-		○
	413	18,4	8,1	PTFE B602/FKM	PT 2	49035995	-		○
385	418	18,4	8,1	PTFE B602/NBR	PT 2	24353627	-		○
390	405	13	6,5	85 NBR B247	P 8	49035280	-		○
	406	11	11,5	PTFE B602/NBR	PT 1	24351468	-		○
	420	27	18	85 NBR B247	P 9	24224940	-		○
395	411	11	11,5	PTFE B602/NBR	PT 1	49027293	-		○
400	415	13	6,5	85 NBR B247	P 8	24354805	-		○
	416	11	11,5	PTFE B602/FKM	PT 1	24338879	-		○
	416	11	11,5	PTFE GM201/FKM	PT 1	24351704	-		○
	416	13	11	A505	LBH	CL0529-C0	-	○	
	424	14,8	15,5	PTFE B602/NBR	PT 1	24345418	-		○
	424	14,8	15,5	PTFE GM201/NBR	PT 1	49012517	IP		●
	430	27	18	85 NBR B247	P 9	24170712	IP		●
	433	18,4	8,1	PTFE B602/NBR	PT 2	24353007	-		○
410	433	18,4	8,1	PTFE B602/FKM	PT 2	49016772	-		○
	434	14,8	15,5	PTFE B602/NBR	PT 1	532389	-		○
	434	14,8	15,5	PTFE GM201/NBR	PT 1	49019717	-		○
	440	27	18	85 NBR B247	P 9	24224936	-		○
420	435	13	6,5	85 NBR B247	P 8	24354806	-		○
	444	14,8	15,5	PTFE B602/NBR	PT 1	24353639	-		○
	444	14,8	15,5	PTFE GM201/NBR	PT 1	49008822	IP		●
	450	27	18	85 NBR B247	P 9	24170651	IP		●
	453	18,4	8,1	PTFE B602/NBR	PT 2	24331444	-		○
	425	440	13	6,5	85 NBR B247	P 8	24355391	-	
430	454	14,8	15,5	PTFE B602/NBR	PT 1	24348077	IP		●
	460	27	18	85 NBR B247	P 9	24178040	-		○
	463	18,4	8,1	PTFE B602/NBR	PT 2	24354755	-		○
431,8	464,8	18,4	8,1	PTFE B602/NBR	PT 2	24342995	-		○
440	455	13	6,5	85 NBR B247	P 8	24355392	-		○
	464	14,8	15,5	PTFE GM201/FKM	PT 1	526025	-		○

d [mm]	D [mm]	H [mm]	L [mm]	Material	Design	Part No.	PU ¹⁾	US	EU
440	464	14,8	15,5	PTFE B602/NBR	PT 1	24378393	-		○
	470	27	18	85 NBR B247	P 9	24224924	IP		●
	473	18,4	8,1	PTFE B602/NBR	PT 2	24363240	-		○
445	460	13	6,5	85 NBR B247	P 8	49017720	-		○
	469	14,8	15,5	PTFE GM201/NBR	PT 1	49004004	-		○
450	465	13	6,5	85 NBR B247	P 8	24355393	IP		●
	474	14,8	15,5	PTFE B602/NBR	PT 1	24345800	-		○
	480	27	18	85 NBR B247	P 9	24224958	-		○
	483	18,4	8,1	PTFE B602/NBR	PT 2	24358970	-		○
460	475	13	6,5	85 NBR B247	P 8	24354807	-		○
	484	14,8	15,5	PTFE B602/NBR	PT 1	24344532	-		○
	490	27	18	85 NBR B247	P 9	24224942	-		○
465	489	14,8	15,5	PTFE GM201/NBR	PT 1	49009443	IP		●
470	485	13	6,5	85 NBR B247	P 8	49017615	-		○
	494	14,8	15,5	PTFE B602/NBR	PT 1	24370827	IP		●
	500	27	18	85 NBR B247	P 9	24224960	-		○
	503	18,4	8,1	PTFE B602/FKM	PT 2	24327546	-		○
	503	18,4	8,1	PTFE B602/NBR	PT 2	49033427	-		○
475	499	14,8	15,5	PTFE GM201/NBR	PT 1	49012518	IP		●
480	495	13	6,5	85 NBR B247	P 8	24355394	-		○
	504	14,8	15,5	PTFE B602/NBR	PT 1	24372747	-		○
	510	27	18	85 NBR B247	P 9	24224941	-		○
	513	18,4	8,1	PTFE B602/NBR	PT 2	24338000	-		○
485	500	13	9,5	85 NBR B247	P 8	530782	-		○
490	505	13	6,5	85 NBR B247	P 8	24379846	-		○
	520	27	18	85 NBR B247	P 9	24224957	-		○
495	519	14,8	15,5	PTFE GM201/NBR	PT 1	49010394	IP		●
500	515	13	6,5	85 NBR B247	P 8	24354808	-		○
	520	15,5	12,5	A505	LBH	CL0460-C0	-	○	
	530	27	18	85 NBR B247	P 9	24224925	IP		●
	533	18,4	8,1	PTFE B602/FKM	PT 2	24347054	-		○
	533	18,4	8,1	PTFE B602/NBR	PT 2	24360955	-		○
510	534	14,8	15,5	PTFE B602/NBR	PT 1	24372882	-		○
	534	14,8	15,5	PTFE GM201/FKM	PT 1	49006826	-		○
	540	27	18	85 NBR B247	P 9	24224943	-		○
	543	18,4	8,1	PTFE B602/NBR	PT 2	24372692	-		○
515	539	14,8	15,5	PTFE B602/NBR	PT 1	49003825	-		○
520	544	14,8	15,5	PTFE B602/NBR	PT 1	24345673	-		○
	544	14,8	15,5	PTFE GM201/NBR	PT 1	49008973	IP		●
	550	27	18	85 NBR B247	P 9	24224956	-		○
	553	18,4	8,1	PTFE B602/FKM	PT 2	24370787	-		○
	525	549	14,8	15,5	PTFE GM201/NBR	PT 1	49012519	IP	
530	554	14,8	15,5	PTFE B602/FKM	PT 1	24370401	-		○
	554	14,8	15,5	PTFE B602/NBR	PT 1	49015260	-		○
	560	27	18	85 NBR B247	P 9	24224932	-		○
	563	18,4	8,1	PTFE B602/NBR	PT 2	24363241	-		○
540	555	13	6,5	85 NBR B247	P 8	24355395	-		○
	564	14,8	15,5	PTFE B602/NBR	PT 1	24369294	-		○
	570	27	18	85 NBR B247	P 9	24224955	-		○
	573	18,4	8,1	PTFE B602/FKM	PT 2	24371034	-		○

d [mm]	D [mm]	H [mm]	L [mm]	Material	Design	Part No.	PU ¹⁾	US	EU
550	565	13	6,5	85 NBR B247	P 8	24355396	-		○
	574	14,8	15,5	PTFE B602/NBR	PT 1	49037157	-		○
	580	27	18	85 NBR B247	P 9	24224964	-		○
	583	18,4	8,1	PTFE B602/NBR	PT 2	24362840	-		○
	583	18,4	8,1	PTFE B602/FKM	PT 2	49044471	-		○
558,8	582,8	14,8	15,5	PTFE B602/NBR	PT 1	24361622	-		○
560	575	13	6,5	85 NBR B247	P 8	24354809	-		○
	590	27	18	85 NBR B247	P 9	24224954	-		○
	593	18,4	8,1	PTFE B602/FKM	PT 2	533488	-		○
	593	18,4	8,1	PTFE B602/NBR	PT 2	24339610	-		○
570	585	13	6,5	85 NBR B247	P 8	49023111	-		○
	594	14,8	15,5	PTFE GM201/NBR	PT 1	49009444	IP		●
	600	27	18	85 NBR B247	P 9	24224944	-		○
580	595	13	6,5	85 NBR B247	P 8	24357108	-		○
	604	14,8	15,5	PTFE B602/NBR	PT 1	49035875	-		○
	610	27	18	85 NBR B247	P 9	24224933	-		○
585	609	14,8	15,5	PTFE GM201/NBR	PT 1	49012520	IP		●
590	605	13	6,5	85 NBR B247	P 8	24355397	-		○
	614	14,8	15,5	PTFE B602/FKM	PT 1	24328251	-		○
	614	14,8	15,5	PTFE B602/NBR	PT 1	24377862	-		○
	620	27	18	85 NBR B247	P 9	24224945	-		○
600	615	13	6,5	85 NBR B247	P 8	24354810	-		○
	624	14,8	15,5	PTFE B602/NBR	PT 1	24374052	-		○
	630	27	18	85 NBR B247	P 9	24224926	-		○
	633	18,4	8,1	PTFE B602/NBR	PT 2	24331445	-		○
610	640	27	18	85 NBR B247	P 9	24262532	-		○
620	644	14,8	15,5	PTFE B602/NBR	PT 1	24370196	-		○
	644	14,8	15,5	PTFE GM201/NBR	PT 1	49027854	-		○
	650	27	18	85 NBR B247	P 9	24224953	-		○
	656,5	19,8	9,5	PTFE B602/NBR	PT 2	49014759	-		○
630	645	13	6,5	85 NBR B247	P 8	24354811	-		○
	654	14,8	15,5	PTFE B602/NBR	PT 1	49015994	-		○
	660	27	18	85 NBR B247	P 9	24222458	IP		●
	666,5	19,8	9,5	PTFE B602/NBR	PT 2	24349708	-		○
635	659	14,8	15,5	PTFE GM201/NBR	PT 1	49012435	IP		●
640	664	14,8	15,5	PTFE GM201/NBR	PT 1	532207	-		○
	664	14,8	15,5	PTFE B602/NBR	PT 1	49006165	-		○
	676,5	19,8	9,5	PTFE B602/NBR	PT 2	24348256	-		○
	676,5	19,8	9,5	PTFE B602/FKM	PT 2	24357491	-		○
650	665	13	6,5	85 NBR B247	P 8	24355398	-		○
	677,3	17,2	18	PTFE B602/NBR	PT 1	49038729	-		○
	680	27	18	85 NBR B247	P 9	24224946	-		○
660	690	27	18	85 NBR B247	P 9	24287716	-		○
670	685	13	6,5	85 NBR B247	P 8	24359048	-		○
	700	27	18	85 NBR B247	P 9	24224934	-		○
	706,5	19,8	9,5	PTFE B602/NBR	PT 2	24346164	IP		●
675	702,3	17,2	18	PTFE GM201/NBR	PT 1	49012436	IP		●
680	695	13	6,5	85 NBR B247	P 8	24354812	IP		●
	707,3	17,2	18	PTFE B602/NBR	PT 1	49026184	-		○
	710	27	18	85 NBR B247	P 9	24238455	-		○

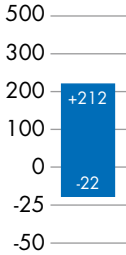
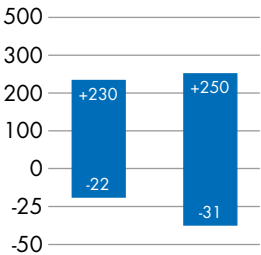
d [mm]	D [mm]	H [mm]	L [mm]	Material	Design	Part No.	PU ¹⁾	US	EU
690	717,3	17,2	18	PTFE B602/NBR	PT 1	528033	-		○
	720	27	18	85 NBR B247	P 9	24221251	-		○
695	725	27	18	85 NBR B247	P 9	24296288	-		○
700	730	27	18	85 NBR B247	P 9	24224952	-		○
	736,5	19,8	9,5	PTFE B602/NBR	PT 2	49035756	-		○
710	725	13	6,5	85 NBR B247	P 8	24355399	-		○
	740	27	18	85 NBR B247	P 9	24216448	-		○
720	750	27	18	85 NBR B247	P 9	24224947	-		○
730	760	27	18	85 NBR B247	P 9	49018767	-		○
	766,5	19,8	9,5	PTFE B602/NBR	PT 2	531292	-		○
740	770	27	18	85 NBR B247	P 9	24224951	-		○
	776,5	19,8	9,5	PTFE B602/FKM	PT 2	529324	-		○
745	776,5	19,8	9,5	PTFE B602/NBR	PT 2	24344400	-		○
	772,3	17,2	18	PTFE GM201/NBR	PT 1	49012437	IP		●
748	784,5	19,8	9,5	PTFE B602/NBR	PT 2	49035130	-		○
749	785,5	19,8	9,5	PTFE B602/NBR	PT 2	49009337	-		○
	765	13	6,5	85 NBR B247	P 8	24355400	-		○
750	780	27	18	85 NBR B247	P 9	24233258	-		○
	786,5	19,8	9,5	PTFE B602/NBR	PT 2	24367379	-		○
760	790	27	18	85 NBR B247	P 9	24224948	-		○
770	800	27	18	85 NBR B247	P 9	24353518	-		○
	806,5	19,8	9,5	PTFE B602/FKM	PT 2	24353425	-		○
775	805	27	18	85 NBR B247	P 9	24295917	-		○
780	810	27	18	85 NBR B247	P 9	24217401	IP		●
	820	27	18	85 NBR B247	P 9	24302433	-		○
790	826,5	19,8	9,5	PTFE B602/NBR	PT 2	24368078	-		○
	831,5	19,8	9,5	PTFE B602/NBR	PT 2	24344331	-		○
800	815	13	6,5	85 NBR B247	P 8	24355401	-		○
	827,3	17,2	18	PTFE B602/NBR	PT 1	24348235	-		○
	830	27	18	85 NBR B247	P 9	24215532	-		○
	836,5	19,8	9,5	PTFE B602/NBR	PT 2	24341037	-		○
	836,5	19,8	9,5	PTFE B602/FKM	PT 2	24358811	-		○
810	840	27	18	85 NBR B247	P 9	24264154	-		○
815	842,3	17,2	18	PTFE GM201/NBR	PT 1	49012438	IP		●
	850	27	18	85 NBR B247	P 9	24224935	-		○
820	856,5	19,8	9,5	PTFE B602/NBR	PT 2	24349213	-		○
	856,5	19,8	9,5	PTFE B602/FKM	PT 2	24357495	-		○
824	839	13	6,5	85 NBR B247	P 8	24373706	-		○
830	860	27	18	85 NBR B247	P 9	49003545	-		○
	866,5	19,8	9,5	PTFE B602/NBR	PT 2	24344384	-		○
840	855	13	6,5	85 NBR B247	P 8	527160	-		○
	870	27	18	85 NBR B247	P 9	24224961	-		○
850	880	27	18	85 NBR B247	P 9	24215590	-		○
	886,5	19,8	9,5	PTFE B602/NBR	PT 2	24314623	-		○
860	890	27	18	85 NBR B247	P 9	24224963	IP		●
	896,5	19,8	9,5	PTFE B602/NBR	PT 2	24374444	-		○
870	900	27	18	85 NBR B247	P 9	24295918	-		○
880	910	27	18	85 NBR B247	P 9	24224962	-		○
885	912,3	17,2	18	PTFE B602/NBR	PT 1	525928	-		○
890	920	27	18	85 NBR B247	P 9	24297999	-		○

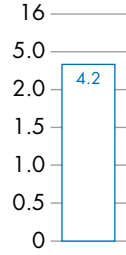
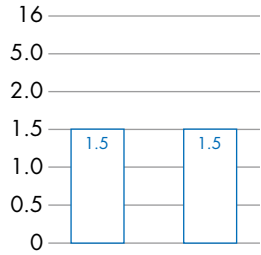
d [mm]	D [mm]	H [mm]	L [mm]	Material	Design	Part No.	PU ¹⁾	US	EU
900	927,3	17,2	18	PTFE B602/NBR	PT 1	526605	-		○
	930	27	18	85 NBR B247	P 9	24224950	-		○
	936,5	19,8	9,5	PTFE B602/NBR	PT 2	24374392	-		○
905	920	13	6,5	85 NBR B247	P 8	24368328	-		○
910	937,3	17,2	18	PTFE GM201/NBR	PT 1	49012439	IP		●
920	947,3	17,2	18	PTFE B602/NBR	PT 1	24378522	-		○
	950	27	18	85 NBR B247	P 9	24345992	-		○
950	965	13	6,5	85 NBR B247	P 8	527757	-		○
	980	27	18	85 NBR B247	P 9	24233241	-		○
	986,5	19,8	9,5	PTFE B602/NBR	PT 2	24356339	-		○
	986,5	19,8	9,5	PTFE B602/FKM	PT 2	24357110	-		○
960	990	27	18	85 NBR B247	P 9	24224928	IP		●
970	1000	27	18	85 NBR B247	P 9	24361394	-		○
	1006,50	19,8	9,5	PTFE B602/NBR	PT 2	24359661	-		○
980	1010	27	18	85 NBR B247	P 9	24293775	-		○
990	1020	27	18	85 NBR B247	P 9	49007878	-		○
1000	1015	13	6,5	85 NBR B247	P 8	24357109	-		○
1020	1050	27	18	85 NBR B247	P 9	24353379	-		○
1040	1070	27	18	85 NBR B247	P 9	24331194	-		○
1050	1080	27	18	85 NBR B247	P 9	24306433	-		○
1060	1090	27	18	85 NBR B247	P 9	24350174	-		○
1070	1100	27	18	85 NBR B247	P 9	24228839	-		○
1100	1130	27	18	85 NBR B247	P 9	24250720	-		○
1110	1140	27	18	85 NBR B247	P 9	24237246	-		○
1120	1150	27	18	85 NBR B247	P 9	49017722	-		○
1130	1160	27	18	85 NBR B247	P 9	24378267	-		○
	1166,50	19,8	9,5	PTFE B602/NBR	PT 2	530018	-		○
1160	1196,50	19,8	9,5	PTFE B602/NBR	PT 2	24371028	-		○
1170	1200	27	18	85 NBR B247	P 9	24341374	-		○
1210	1240	27	18	85 NBR B247	P 9	24362171	-		○
1220	1250	27	18	85 NBR B247	P 9	24259753	-		○
1250	1280	27	18	85 NBR B247	P 9	24302041	-		○
1260	1290	27	18	85 NBR B247	P 9	24342022	-		○
1300	1330	27	18	85 NBR B247	P 9	24292824	-		○
1320	1356,50	19,8	9,5	PTFE B602/NBR	PT 2	527134	-		○
1350	1380	27	18	85 NBR B247	P 9	24290793	-		○
1370	1400	27	18	85 NBR B247	P 9	24332613	-		○
1375	1411,50	19,8	9,5	PTFE B604/NBR	PT 2	49004721	-		○
1380	1410	27	18	85 NBR B247	P 9	24378270	-		○
1420	1450	27	18	85 NBR B247	P 9	24362130	-		○
1450	1480	27	18	85 NBR B247	P 9	24302595	-		○
1500	1536,50	19,8	9,5	PTFE B604/NBR	PT 2	49006761	-		○
1560	1590	27	18	85 NBR B247	P 9	532782	-		○
1580	1610	27	18	85 NBR B247	P 9	24336748	-		○
1660	1690	27	18	85 NBR B247	P 9	24357172	-		○
1700	1730	27	18	85 NBR B247	P 9	49019211	-		○
1750	1780	27	18	85 NBR B247	P 9	24262918	-		○
1800	1830	27	18	85 NBR B247	P 9	49012005	-		○
1960	1990	27	18	85 NBR B247	P 9	24259169	-		○
2000	2030	27	18	85 NBR B247	P 9	24294574	-		○
2450	2480	27	18	85 NBR B247	P 9	24378197	-		○

Type	H	DMRW																	
Standard	AS	AS																	
Shape																			
Compound	Polyurethan 90 AU 2097	Polyurethan 92 AU 9250	Polyurethan 94 AU 3000																
	 <table border="1"> <tr><th>Temp</th><th>Value</th></tr> <tr><td>+212</td><td></td></tr> <tr><td>-22</td><td></td></tr> </table>	Temp	Value	+212		-22		 <table border="1"> <tr><th>Temp</th><th>Value</th></tr> <tr><td>+230</td><td></td></tr> <tr><td>+250</td><td></td></tr> <tr><td>-22</td><td></td></tr> <tr><td>-31</td><td></td></tr> </table>		Temp	Value	+230		+250		-22		-31	
Temp	Value																		
+212																			
-22																			
Temp	Value																		
+230																			
+250																			
-22																			
-31																			
	 <table border="1"> <tr><th>Value</th><th>Temp</th></tr> <tr><td>4.2</td><td></td></tr> </table>	Value	Temp	4.2		 <table border="1"> <tr><th>Value</th><th>Temp</th></tr> <tr><td>1.5</td><td></td></tr> <tr><td>1.5</td><td></td></tr> </table>		Value	Temp	1.5		1.5							
Value	Temp																		
4.2																			
Value	Temp																		
1.5																			
1.5																			
Applications																			

Bitte beachten Sie unsere allgemeinen Konstruktionshinweise in → Technisches Handbuch

Daha detaylı montaj bilgisi için → Bkz. Technical Manual

W celu zaznajomienia się z ogólnymi uwagami proszę skorzystać z Instrukcji

Общие технические рекомендации см. → Техническое руководство

DOPPELT WIRKENDE ABSTREIFER | ÇİFT ETKİLİ SIYIRICILAR ZGARNIACZE PODWÓJNIE | ГРЯЗЕСЪЕМНИКИ ДВУХСТОРОННЕГО ДЕЙСТВИЯ

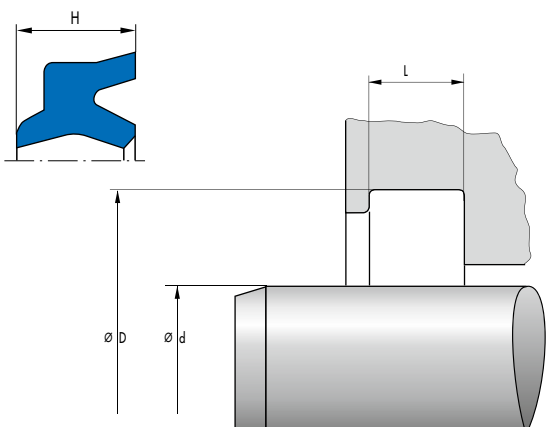

Wenn Sie Ihre Dichtung nicht finden können – Ihre Lösung auf Seite 12
Aradığınız ürünü bulamadığınız takdirde – çözümünüz sayfa 12
Jeżeli nie możecie Państwo znaleźć uszczelki – rozwiązanie znajduje się na stronie 12
Вы не можете подобрать необходимое уплотнение? – Решение на странице 12

1) IP = Industriepackung | Endüstriyel ambalaj | Opakowania przemysłowe | Производственная тара
SP = Einzelpackung | Tek bir Paketi | Pojedyncze opakowanie | Single Pack

● Auf Lager | Stoklarda mevcuttur | Dostępne w magazynie | Имеется в наличии на складе
○ Auf Anfrage | Talep üzerine | Na zapytanie | По запросу

d [inch]	D [inch]	H [inch]	L [inch]	Material	Design	Part No.	PU ¹⁾	US	EU
0,375	0,677	0,254	0,203	90 AU 2097	H	56H-0375	–	○	
0,5	0,802	0,254	0,203	90 AU 2097	H	56H-0500	–	○	
0,625	0,927	0,254	0,203	90 AU 2097	H	56H-0625	–	●	
0,75	1,052	0,254	0,203	90 AU 2097	H	56H-0750	–	○	
0,812	1,177	0,273	0,218	90 AU 2097	H	56H-0812	–	○	
0,875	1,24	0,273	0,218	90 AU 2097	H	56H-0875	–	○	
1	1,365	0,273	0,218	90 AU 2097	H	56H-1000	–	●	
1,125	1,49	0,273	0,218	90 AU 2097	H	56H-1125	–	●	
1,187	1,552	0,273	0,218	90 AU 2097	H	56H-1187	–	○	
1,25	1,615	0,273	0,218	90 AU 2097	H	56H-1250	–	●	
1,375	1,74	0,273	0,218	90 AU 2097	H	56H-1375	–	○	
1,5	1,865	0,273	0,218	90 AU 2097	H	56H-1500	–	○	
	2,25	0,433	0,433	92 AU 9250	DMRW	560210016000A	–	●	
1,562	1,927	0,273	0,218	90 AU 2097	H	56H-1562	–	○	
1,625	1,99	0,273	0,218	90 AU 2097	H	56H-1625	–	●	
	2,115	0,273	0,218	90 AU 2097	H	56H-1750	–	●	
1,75	2,115	0,273	0,218	HT 2053	H	56H-1750-OR	–	○	
	2,438	0,433	0,433	92 AU 9250	DMRW	560210021000A	–	●	
1,875	2,24	0,273	0,218	90 AU 2097	H	56H-1875	–	○	
2	2,365	0,273	0,218	90 AU 2097	H	56H-2000	–	●	
	2,688	0,433	0,433	92 AU 9250	DMRW	560210026000A	–	●	
2,062	2,427	0,273	0,218	90 AU 2097	H	56H-2062	–	○	
2,125	2,49	0,273	0,218	90 AU 2097	H	56H-2125	–	●	
	2,745	0,35	0,281	90 AU 2097	H	56H-2250	–	●	
2,25	2,745	0,35	0,281	HT 2053	H	56H-2250-OR	–	○	
	3	0,433	0,433	92 AU 9250	DMRW	560210032000A	–	●	
2,375	2,87	0,35	0,281	90 AU 2097	H	56H-2375	–	●	
2,5	2,995	0,35	0,281	90 AU 2097	H	56H-2500	–	●	
	3,25	0,413	0,413	92 AU 9250	DMRW	560210039000A	–	●	
2,625	3,12	0,35	0,281	90 AU 2097	H	56H-2625	–	○	

d [inch]	D [inch]	H [inch]	L [inch]	Material	Design	Part No.	PU ¹⁾	US	EU
2,75	3,245	0,35	0,281	90 AU 2097	H	56H-2750	-	●	
	3,75	0,55	0,55	92 AU 9250	DMRW	560210045000A	-	●	
3	3,495	0,35	0,281	90 AU 2097	H	56H-3000	-	●	
	4	0,55	0,55	92 AU 9250	DMRW	560210049000A	-	●	
3,125	3,62	0,35	0,281	90 AU 2097	H	56H-3125	-	●	
3,25	3,745	0,35	0,281	90 AU 2097	H	56H-3250	-	○	
	4,25	0,55	0,55	92 AU 9250	DMRW	560210054000A	-	●	
3,5	3,995	0,35	0,281	90 AU 2097	H	56H-3500	-	●	
	4,5	0,55	0,55	92 AU 9250	DMRW	560210060000A	-	●	
3,625	4,12	0,35	0,281	90 AU 2097	H	56H-3625	-	○	
3,75	4,245	0,35	0,281	90 AU 2097	H	56H-3750	-	○	
	4,75	0,55	0,55	92 AU 9250	DMRW	560210064000A	-	●	
3,875	4,37	0,35	0,281	90 AU 2097	H	56H-3875	-	○	
4	4,495	0,35	0,281	90 AU 2097	H	56H-4000	-	○	
	5	0,55	0,55	92 AU 9250	DMRW	560210068000A	-	●	
4,5	4,995	0,35	0,281	90 AU 2097	H	56H-4500	-	●	
4,75	5,245	0,35	0,281	90 AU 2097	H	56H-4750	-	○	
5	5,495	0,35	0,281	90 AU 2097	H	56H-5000	-	●	
	6	0,55	0,55	92 AU 9250	DMRW	560210094000A	-	●	
5,125	5,62	0,35	0,281	90 AU 2097	H	56H-5125	-	○	
5,25	5,745	0,35	0,281	90 AU 2097	H	56H-5250	-	○	
5,5	5,995	0,35	0,281	90 AU 2097	H	56H-5500	-	●	
5,75	6,75	0,55	0,55	92 AU 9250	DMRW	560210095000A	-	○	
6	6,495	0,35	0,281	90 AU 2097	H	56H-6000	-	●	
6,5	6,995	0,35	0,281	90 AU 2097	H	56H-6500	-	○	
6,75	7,75	0,55	0,55	92 AU 9250	DMRW	560210090000A	-	○	
7	7,495	0,35	0,281	90 AU 2097	H	56H-7000	-	●	
	8	0,55	0,55	92 AU 9250	DMRW	560210092000A	-	●	
8	8,495	0,35	0,281	90 AU 2097	H	56H-8000	-	○	
9,5	10,247	0,585	0,374	93 AU 2093	H	56D-9500	-	○	
9,75	10,497	0,585	0,374	93 AU 2093	H	56D-9750	-	○	

Type	EKF	FRA	KB	KBK	KF	RYT
Standard	ISO	ISO	ISO	ISO	ISO	JIS
Shape						
Compound	Polyamide PA4201	Polyamide PA4112	Fabric base laminate HG517 HG600	Fabric base laminate HG517 HG650	PTFE B500	PTFE 05ZF
	 200 — 100 — 50 — 0 — -50 — -100 — -200 —	 200 — 100 — 50 — 0 — -50 — -100 — -200 —	 200 — 100 — 50 — 0 — -50 — -100 — -200 —	 200 — 100 — 50 — 0 — -50 — -100 — -200 —	 200 — 100 — 50 — 0 — -50 — -100 — -200 —	 200 — 100 — 50 — 0 — -50 — -100 — -200 —
	 15 — 5,0 — 2,0 — 1,5 — 1,0 — 0,5 — 0 —	 15 — 5,0 — 2,0 — 1,5 — 1,0 — 0,5 — 0 —	 15 — 5,0 — 2,0 — 1,5 — 1,0 — 0,5 — 0 —	 15 — 5,0 — 2,0 — 1,5 — 1,0 — 0,5 — 0 —	 15 — 5,0 — 2,0 — 1,5 — 1,0 — 0,5 — 0 —	 15 — 5,0 — 2,0 — 1,5 — 1,0 — 0,5 — 0 —
Applications						

Bitte beachten Sie unsere allgemeinen Konstruktionshinweise in → Technisches Handbuch

Daha detaylı montaj bilgisi için → Bkz. Technical Manual

W celu zaznajomienia się z ogólnymi uwagami proszę skorzystać z Instrukcji

Общие технические рекомендации см. → Техническое руководство

KOLBENFÜHRUNGSRINGE | PISTON YATAKLAMA ELEMANLARI PROWADNICA TŁOKA | ПОРШНЕВЫЕ НАПРАВЛЯЮЩИЕ КОЛЬЦА

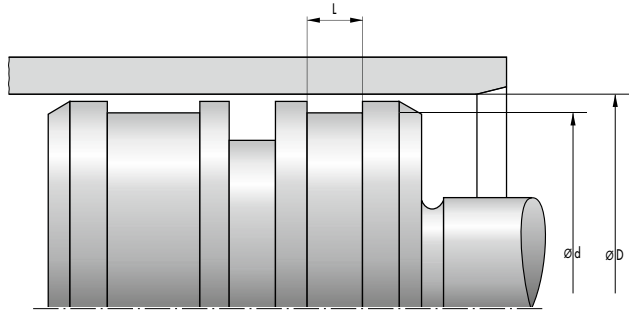
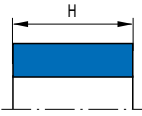

Wenn Sie Ihre Dichtung nicht finden können – Ihre Lösung auf Seite 12
 Aradığınız ürünü bulamadığınız takdirde – çözümünüz sayfa 12
 Jeżeli nie możecie Państwo znaleźć uszczelki – rozwiązanie znajduje się na stronie 12
 Вы не можете подобрать необходимое уплотнение? – Решение на странице 12

1) IP = Industriepackung | Endüstriyel ambalaj | Opakowania przemysłowe | Производственная тара
 SP = Einzelpackung | Tek bir Paket | Pojedyncze opakowanie | Single Pack

● Auf Lager | Stoklarda mevcuttur | Dostępne w magazynie | Имеется в наличии на складе
 ○ Auf Anfrage | Talep üzerine | Na zapytanie | По запросу

d [mm]	D [mm]	H [mm]	L [mm]	Material	Design	Part No.	PU ¹⁾	US	EU
16	16	8	8,2	PA 4201	EKF	94215	IP		●
						40421816	SP		●
20	16,9	3,9	4	PA 4112	FRA	434212	IP		●
						40421992	SP		●
						24300179	–		○
22	19	5,5	5,6	PTFE B500	KF	24300180	–	○	
25	21	8	8,2	PA 4201	EKF	99664	IP	○	●
						40421826	SP		●
						99664-SIM	–		
25	21,9	3,9	4	PA 4112	FRA	434213	IP		●
						40421993	SP		●
						24300182	–		○
28	25	5,5	5,6	PTFE B500	KF	24300183	–	○	
30	26	8	8,2	PA 4201	EKF	99665	IP		●
						40421827	SP		●
						434214	–		○
						24300231	IP		●
30	26,9	3,9	4	PA 4112	FRA	40422410	SP		●
						24300232	–		○
						24300184	–		○
32	28	8	8,2	PA 4201	EKF	94044	IP		●
						40421811	SP		●
						434215	IP		●
						40421994	SP		●
32	28,9	3,9	4	PA 4112	FRA	24300232	–		○
						24300185	–		○
						24300232	–		○
35	31	8	8,2	PA 4201	EKF	1264	IP		●
						40421002	SP		●
						434217	IP		●
						40421995	SP		●
35	31,9	3,9	4	PA 4112	FRA	24300186	IP		●
						24300234	–		○
						24300187	–		○
36	33	5,5	5,6	HGW HG517	KB	–	–		○
						–	–		○
40	35	5,4	5,6	PA 4112	FRA	424740	IP		●
						40421964	SP		●
						24130923	–		○
40	35	5,5	5,6	HGW HG517	KB	–	–	○	

d [mm]	D [mm]	H [mm]	L [mm]	Material	Design	Part No.	PU ¹⁾	US	EU
40	35	5,5	5,6	PTFE B500	KF	24168850	IP		●
	35	9,5	9,7	HGW HG650	KBK	49005755	–		○
	35	14,8	15	HGW HG517	KBK	24373629	–		○
	35	14,8	15	HGW HG650	KBK	49005756	–		○
	36	8	8,2	PA 4201	EKF	99422 40421821	IP SP		● ●
	37	5,5	5,6	HGW HG517	KB	24300235	IP		●
	37	5,5	5,6	PTFE B500	KF	24300188	IP		●
42	37	5,5	5,6	HGW HG517	KB	24130926	–		○
	37	5,5	5,6	PTFE B500	KF	24300189	–		○
45	40	5,4	5,6	PA 4112	FRA	428783 40421970	IP SP		● ●
	40	5,5	5,6	HGW HG517	KB	24130929	–		○
	40	5,5	5,6	PTFE B500	KF	24108647	IP		●
	40	9,5	9,7	HGW HG650	KBK	49005758	–		○
	40	14,8	15	HGW HG650	KBK	49005759	–		○
	41	10	10,2	PA 4201	EKF	94191 40421812	IP SP		● ●
	42	5,5	5,6	PTFE B500	KF	24312965	–		○
50	45	5,4	5,6	PA 4112	FRA	423806 40421961	IP SP		● ●
	45	5,5	5,6	HGW HG517	KB	24130932	–		○
	45	5,5	5,6	PTFE B500	KF	24162171	IP		●
	45	9,5	9,7	HGW HG517	KBK	24376320 40422511	IP SP		● ●
	45	9,5	9,7	HGW HG650	KBK	49005771	–		○
	45	9,6	9,7	HGW HG517	KB	24130933 40422125	IP SP		● ●
	45	9,6	9,7	PTFE B500	KF	24340072	–		○
	45	14,8	15	HGW HG650	KBK	49005772	IP		●
55	46	10	10,2	PA 4201	EKF	99423 40421822	IP SP		● ●
	50	5,5	5,6	HGW HG517	KB	24130935 40422126	IP SP		● ●
	50	5,5	5,6	PTFE B500	KF	24300190	IP		●
	50	9,5	9,7	PA 4112	FRA	428789 40421971	IP SP		● ●
	50	9,5	9,7	HGW HG650	KBK	49005773	–		○
	50	14,8	15	HGW HG650	KBK	49005774	–		○
	51	10	10,2	PA 4201	EKF	99424 40421823	IP SP		● ●
56	51	5,5	5,6	HGW HG517	KB	24130938	–		○
	51	5,5	5,6	PTFE B500	KF	24260615	–		○
58	54	10	10,2	PA 4201	EKF	95290	–		○
60	55	5,5	5,6	HGW HG517	KB	24130941	–		○
	55	5,5	5,6	PTFE B500	KF	24210205	–		○
	55	9,5	9,7	PA 4112	FRA	428800 40421972	IP SP		● ●
	55	9,5	9,7	HGW HG517	KBK	24381008	–		○
	55	9,5	9,7	HGW HG650	KBK	49005777	–		○
	55	9,6	9,7	HGW HG517	KB	24130942	–		○
	55	9,6	9,7	PTFE B500	KF	24163238	–		○
	55	9,9	10	HGW HG517	KB	24375278 40422503	IP SP		● ●
55	14,8	15	HGW HG650	KBK	49005778	–		○	

d [mm]	D [mm]	H [mm]	L [mm]	Material	Design	Part No.	PU ¹⁾	US	EU
60	56	10	10,2	PA 4201	EKF	99375	IP		●
						40421819			SP
63	58	5,5	5,6	HGW HG517	KB	24130944	IP		●
						40422127			SP
	58	9,5	9,7	PA 4112	FRA	424703	IP		●
						40421963			SP
	58	9,5	9,7	HGW HG517	KBK	24377609	IP		●
						40422513			SP
24130945						IP			●
58	9,6	9,7	HGW HG517	KB	24130945	IP		●	
					24169847			IP	●
59	10	10,2	PA 4201	EKF	99861	IP		●	
					40421830			SP	●
65	60	9,5	9,7	PA 4112	FRA	428802	IP		●
						40421973			SP
	60	9,5	9,7	HGW HG517	KBK	24379281	-		○
						49005792			KBK
	60	9,6	9,7	HGW HG517	KB	24133632	IP		●
						40422148			SP
	60	9,6	9,7	PTFE B500	KF	24300192	-		○
						49005793			KBK
	61	10	10,2	PA 4201	EKF	99368	IP		●
						40421818			SP
70	62	24,5	25	HGW HG517	KB	24298678	-		○
						434199			IP
	65	9,5	9,7	PA 4112	FRA	40421991	SP		
						24378390			-
	65	9,5	9,7	HGW HG517	KBK	49005794	-		
						24130948			IP
	65	9,6	9,7	HGW HG517	KB	24165146	IP		
						24345783			-
	65	14,8	15	HGW HG517	KB	24345783	-		
						49005795			-
	65	14,8	15	HGW HG650	KBK	49005795	-		
						24338058			-
66	10	10,2	PA 4201	EKF	99739	IP		●	
					40421828			SP	●
75	67	14,8	15	HGW HG517	KBK	49005284	-		○
						428814			IP
	70	9,5	9,7	PA 4112	FRA	40421975	SP		
						24379280			-
	70	9,5	9,7	HGW HG517	KBK	49005796	-		
						24220353			IP
	70	9,6	9,7	HGW HG517	KB	40422211	SP		
						24300193			-
70	9,6	9,7	PTFE B500	KF	24300193	-		○	
					49005797			-	
71	15	15,2	PA 4201	EKF	94192	IP			
					40421813			SP	●
80	71	9,6	9,7	PTFE B500	KF	24264453	-		○
						424702			IP
	75	9,5	9,7	PA 4112	FRA	40421962	SP	○	
						24378388			IP
	75	9,5	9,7	HGW HG517	KBK	40422514	SP		
						49002931			-
	75	9,5	9,7	HGW HG650	KBK	24130950	IP		
40422128						SP			
75	9,6	9,7	HGW HG517	KB	24217207		IP		
					24128202	IP			
75	14,8	15	HGW HG517	KB	40422124		SP		
					49005798	-			
75	14,8	15	HGW HG650	KBK	49005798		-		

d [mm]	D [mm]	H [mm]	L [mm]	Material	Design	Part No.	PU ¹⁾	US	EU
80	75	19,8	20	HGW HG650	KBK	49018501	–		○
	76	15	15,2	PA 4201	EKF	34024 40421743	IP SP		● ●
85	80	9,5	9,7	HGW HG517	KBK	24380508	–		○
	80	9,5	9,7	HGW HG650	KBK	49005812	–		○
	80	9,6	9,7	HGW HG517	KB	24135787 40422149	IP SP		● ●
	80	9,6	9,7	PTFE B500	KF	24169641	IP		●
	80	14,8	15	HGW HG517	KB	24351574	–		○
	80	14,8	15	HGW HG650	KBK	49005828	–		○
	80	14,8	15	PTFE B500	KF	24258738	–		○
	81	15	15,2	PA 4201	EKF	99331	–		○
90	85	9,5	9,7	PA 4112	FRA	428815 40421976	IP SP	○	● ●
	85	9,5	9,7	HGW HG517	KBK	49000753	–		○
	85	9,5	9,7	HGW HG650	KBK	49005829	–		○
	85	9,6	9,7	HGW HG517	KB	24130952 40422129	IP SP		● ●
	85	9,6	9,7	PTFE B500	KF	24165145	IP		●
	85	14,8	15	HGW HG517	KB	24269687	IP		●
	85	14,8	15	HGW HG650	KBK	49005830	–		○
	85	14,8	15	PTFE B500	KF	24164295	–		○
	85	19,5	20	PTFE B500	KF	24229424	–		○
	86	15	15,2	PA 4201	EKF	99426 40421825	IP SP		● ●
95	90	9,5	9,7	HGW HG517	KBK	24378389	–		○
	90	9,5	9,7	HGW HG650	KBK	49005832	–		○
	90	9,6	9,7	HGW HG517	KB	24300241 40422411	IP SP		● ●
	90	9,6	9,7	PTFE B500	KF	24300197	–		○
	90	14,8	15	HGW HG517	KB	24337625	–		○
	90	14,8	15	HGW HG517	KBK	24380164	–		○
	90	14,8	15	HGW HG650	KBK	49005833	–		○
	90	14,8	15	PTFE B500	KF	24343224	–		○
91	15	15,2	PA 4201	EKF	94193	–		○	
98	93	9,5	9,7	HGW HG517	KBK	528477	–		○
100	92	19,8	20	HGW HG517	KBK	49005017	–		○
	95	9,5	9,7	PA 4112	FRA	426223 40421965	IP SP		● ●
	95	9,5	9,7	HGW HG517	KBK	49002078	–		○
	95	9,5	9,7	HGW HG650	KBK	49005835	–		○
	95	9,6	9,7	HGW HG517	KB	24130954 40422130	IP SP		● ●
	95	9,6	9,7	PTFE B500	KF	24153611	IP		●
	95	14,8	15	PAGF41 Q04112	FRA	433591	IP		●
	95	14,8	15	HGW HG517	KB	24132237 40422147	IP SP		● ●
	95	14,8	15	HGW HG517	KBK	24375947 40422509	IP SP		● ●
	95	14,8	15	HGW HG650	KBK	49005581	–		○
	95	14,8	15	PTFE B500	KF	24165294	–		○
	95	19,8	20	HGW HG517	KBK	24373283	–		○
95	24,5	25	PTFE B500	KF	24311931	–		○	

d [mm]	D [mm]	H [mm]	L [mm]	Material	Design	Part No.	PU ¹⁾	US	EU
100	96	15	15,2	PA 4201	EKF	99376 40421820	IP SP		● ●
105	100	9,5	9,7	HGW HG517	KBK	24367544	–		○
	100	9,5	9,7	HGW HG650	KBK	49005836	–		○
	100	9,6	9,7	HGW HG517	KB	24209853	–		○
	100	9,6	9,7	PTFE B500	KF	24216699	IP		●
	100	19,8	20	HGW HG650	KBK	49018503	–		○
	100	24,5	25	PTFE B500	KF	24333282	–		○
	101	20	20,3	PA 4201	EKF	27257	–		○
110	102	19,8	20	HGW HG517	KBK	24359047	–		○
	102	24,5	25	HGW HG517	KB	24146909	–		○
	102	24,5	25	HGW HG517	KBK	49004871	–		○
	105	9,5	9,7	PA 4112	FRA	428819 40421977	IP SP		● ●
	105	9,5	9,7	HGW HG650	KBK	49005838	–		○
	105	9,6	9,7	HGW HG517	KB	24130956 40422131	IP SP		● ●
	105	9,6	9,7	PTFE B500	KF	24165147	IP		●
	105	14,8	15	PAGF41 Q04112	FRA	433589	IP		●
	105	14,8	15	HGW HG517	KB	24245043 40422336	IP SP		● ●
	105	14,8	15	HGW HG650	KBK	49003729	–		○
	105	14,8	15	PTFE B500	KF	24291125	–		○
	105	19,5	20	PTFE B500	KF	24243431	–		○
	115	105	19,8	20	HGW HG517	KBK	24380278	IP	
105		24,5	25	HGW HG650	KBK	49026578	–		○
106		20	20,3	PA 4201	EKF	99864 40421833	IP SP		● ●
110		9,6	9,7	PTFE B500	KF	24153613	IP		●
110		14,8	15	HGW HG517	KB	24245178	–		○
110		14,8	15	HGW HG517	KBK	24378948	–		○
110		14,8	15	HGW HG650	KBK	49005839	–		○
111		20	20,3	PA 4201	EKF	94194	–		○
112		24,5	25	HGW HG517	KB	24302126	–		○
112		24,5	25	HGW HG517	KBK	49004872	–		○
120		115	9,5	9,7	PA 4112	FRA	428820 40421978	IP SP	
	115	9,5	9,7	HGW HG650	KBK	49038027	–		○
	115	9,6	9,7	HGW HG517	KB	24300246	–		○
	115	9,6	9,7	PTFE B500	KF	24166736	IP		●
	115	14,8	15	PAGF41 Q04112	FRA	433597	IP		●
	115	14,8	15	HGW HG517	KB	24144161	–		○
	115	14,8	15	HGW HG517	KBK	49000752	–		○
	115	14,8	15	PTFE B500	KF	24300203	–		○
	115	19,8	20	HGW HG517	KBK	24380279	–		○
	116	20	20,3	PA 4201	EKF	99740 40421829	IP SP		● ●
125	117	24,5	25	HGW HG517	KB	24137311	–		○
	120	9,5	9,7	PA 4112	FRA	426238 40421966	IP SP		● ●
	120	9,5	9,7	HGW HG517	KBK	49000675	–		○
	120	9,5	9,7	HGW HG650	KBK	49005841	–		○
	120	9,6	9,7	HGW HG517	KB	24130960 3387-130.960	–	○	○

d [mm]	D [mm]	H [mm]	L [mm]	Material	Design	Part No.	PU ¹⁾	US	EU
125	120	9,6	9,7	PTFE B500	KF	24204056	IP		●
	120	14,8	15	HGW HG517	KB	24130961	IP		●
	120	14,8	15	HGW HG517	KBK	24375948 40422510	IP SP		● ●
	120	14,8	15	HGW HG650	KBK	49003232	IP		●
	120	14,8	15	PTFE B500	KF	24165043	–		○
	120	24,5	25	HGW HG517	KB	24174689	–		○
	120	24,5	25	HGW HG650	KBK	49005842	–		○
	121	20	20,3	PA 4201	EKF	99172 40421817	IP SP		● ●
130	122	24,5	25	HGW HG517	KBK	24358243	–		○
	124	19,8	20	HGW HG517	KBK	49002431	–		○
	125	9,5	9,7	HGW HG517	KBK	49002077	–		○
	125	9,5	9,7	HGW HG650	KBK	49005843	–		○
	125	9,6	9,7	PTFE B500	KF	24153612	IP		●
	125	14,8	15	PAGF41 Q041 12	FRA	433598	IP		●
	125	14,8	15	HGW HG650	KBK	49005844	–		○
	125	14,8	15	PTFE B500	KF	24300206	–		○
	125	19,5	20	PTFE B500	KF	24166634	–		○
	125	19,8	20	HGW HG517	KBK	531549	–		○
	125	24,5	25	HGW HG650	KBK	49005845	–		○
	125	24,5	25	HGW HG517	KBK	528114	–		○
	126	20	20,3	PA 4201	EKF	99863 40421832	IP SP		● ●
133,4	128,4	9,9	10	HGW HG517	KB	24375988	–		○
135	130	9,5	9,7	HGW HG650	KBK	49005846	–		○
	130	9,6	9,7	PTFE B500	KF	24203611	–		○
	130	14,8	15	HGW HG650	KBK	49005847	–		○
	130	14,8	15	PTFE B500	KF	24340099	–		○
	131	20	20,3	PA 4201	EKF	34301	–		○
140	132	19,8	20	HGW HG517	KB	24335709	–		○
	132	24,5	25	HGW HG517	KB	24137312	IP		●
	135	9,5	9,7	HGW HG650	KBK	49005899	–		○
	135	9,6	9,7	HGW HG517	KB	24130963	–		○
	135	9,6	9,7	PTFE B500	KF	24102436	IP		●
	135	14,8	15	PA 4112	FRA	428858 40421979	IP SP	○	● ●
	135	14,8	15	HGW HG517	KB	24130964	IP		●
	135	14,8	15	HGW HG517	KBK	24380185	IP		●
	135	14,8	15	HGW HG650	KBK	49005900	–		○
	135	14,8	15	PTFE B500	KF	24236467	IP		●
	135	19,5	20	PTFE B500	KF	24339882	–		○
	135	19,8	20	HGW HG517	KB	24349281	–		○
	135	19,8	20	HGW HG517	KBK	24380281	IP		●
	135	24,5	25	HGW HG650	KBK	49005898	–		○
	135	24,5	25	HGW HG517	KBK	528117	IP		●
	135	24,5	25	PTFE B500	KF	24338745	–		○
	136	20	20,3	PA 4201	EKF	99425 40421824	IP SP		● ●
145	140	24,5	25	HGW HG650	KBK	49020659	IP		●
149	144	14,8	15	HGW HG517	KBK	24380165	–		○
150	142	19,8	20	HGW HG517	KB	24335710	–		○

d [mm]	D [mm]	H [mm]	L [mm]	Material	Design	Part No.	PU ¹⁾	US	EU
150	142	24,5	25	HGW HG517	KB	24146908	–	○	○
	145	9,5	9,7	HGW HG517	KBK	49001347	–	○	○
	145	9,6	9,7	HGW HG517	KB	24130966	–	○	○
	145	9,6	9,7	PTFE B500	KF	24300208	IP	●	●
	145	14,8	15	HGW HG517	KB	24130967	–	○	○
	145	14,8	15	HGW HG650	KBK	49005911	–	○	○
	145	14,8	15	PTFE B500	KF	24169689	IP	●	●
	145	19,5	20	PTFE B500	KF	24336312	–	○	○
	145	19,8	20	HGW HG517	KB	24342275	–	○	○
	145	24,5	25	HGW HG517	KB	24245817	–	○	○
	145	24,5	25	HGW HG517	KBK	529384	–	○	○
	145	24,5	25	PTFE B500	KF	24243485	–	○	○
	146	25	25,4	PA 4201	EKF	94201 40421814	IP SP	●	●
155	150	9,5	9,7	HGW HG650	KBK	49015382	–	○	○
	150	9,6	9,7	PTFE B500	KF	24169405	–	○	○
160	152	24,5	25	HGW HG517	KB	24176821	–	○	○
	155	9,5	9,7	HGW HG650	KBK	49005912	–	○	○
	155	9,6	9,7	HGW HG517	KB	24130969	–	○	○
	155	9,6	9,7	PTFE B500	KF	24168887	–	○	○
	155	14,8	15	PA 4112	FRA	428860 40421980	IP SP	●	●
	155	14,8	15	HGW HG517	KB	24130970	IP	●	●
	155	14,8	15	HGW HG517	KBK	24378946	IP	●	●
	155	14,8	15	HGW HG650	KBK	49005913	–	○	○
	155	14,8	15	PTFE B500	KF	24300209	IP	●	●
	155	19,5	20	PTFE B500	KF	24217554	–	○	○
	155	19,8	20	HGW HG517	KB	24351443	–	○	○
	155	19,8	20	HGW HG517	KBK	526097	–	○	○
	155	24,5	25	HGW HG517	KB	24263520	–	○	○
	155	24,5	25	HGW HG517	KBK	24380280	–	○	○
	155	24,5	25	HGW HG650	KBK	49005914	–	○	○
155	34,5	35	HGW HG517	KBK	24379367	–	○	○	
156	25	25,4	PA 4201	EKF	99862 40421831	IP SP	●	●	
170	162	24,5	25	HGW HG517	KBK	49003985	–	○	○
	165	9,6	9,7	PTFE B500	KF	24300210	–	○	○
	165	14,8	15	HGW HG517	KB	24130973	IP	●	●
	165	14,8	15	HGW HG650	KBK	49005915	–	○	○
	165	14,8	15	PTFE B500	KF	24300211	–	○	○
	165	19,5	20	PTFE B500	KF	24336310	–	○	○
	165	24,5	25	HGW HG650	KBK	49005916	–	○	○
	165	24,5	25	HGW HG517	KBK	526071	IP	●	●
175	170	9,5	9,7	HGW HG650	KBK	49012836	–	○	○
	170	24,5	25	HGW HG650	KBK	49018109	–	○	○
180	172	19,8	20	HGW HG517	KB	24140088	IP	●	●
	172	24,5	25	HGW HG517	KB	24290191	–	○	○
	172	24,5	25	HGW HG517	KBK	24380555	–	○	○
	175	9,5	9,7	HGW HG517	KBK	49001427	–	○	○
	175	9,5	9,7	HGW HG650	KBK	49005917	–	○	○
175	9,6	9,7	HGW HG517	KB	24130975	–	○	○	

d [mm]	D [mm]	H [mm]	L [mm]	Material	Design	Part No.	PU ¹⁾	US	EU
	175	9,6	9,7	PTFE B500	KF	24203474	IP		●
	175	14,8	15	PA 4112	FRA	428863 40421981	IP SP		● ●
	175	14,8	15	HGW HG517	KB	24130976 40422132	IP SP		● ●
180	175	14,8	15	HGW HG517	KBK	24378947 40422515	IP SP		● ●
	175	14,8	15	HGW HG650	KBK	49005918	–		○
	175	14,8	15	PTFE B500	KF	24219351	–		○
	175	24,5	25	PTFE B500	KF	24258396	–		○
	175	34,5	35	HGW HG517	KBK	24377817	–		○
	176	25	25,4	PA 4201	EKF	94204 40421815	IP SP		● ●
185	180	9,5	9,7	HGW HG650	KBK	49015383	–		○
	185	9,6	9,7	PTFE B500	KF	24300212	–		○
	185	14,8	15	HGW HG517	KBK	49003727	–		○
190	185	14,8	15	PTFE B500	KF	24300213	IP		●
	185	24,5	25	HGW HG517	KBK	24379077	–		○
	185	24,5	25	HGW HG650	KBK	49006011	–		○
	192	24,5	25	HGW HG517	KB	24290195	–		○
	192	34,5	35	HGW HG517	KBK	24380583	–		○
	195	9,5	9,7	HGW HG650	KBK	49006013	–		○
	195	9,6	9,7	HGW HG517	KB	24130981	IP		●
	195	9,6	9,7	PTFE B500	KF	24300214	–		○
	195	14,8	15	PAGF41 Q04112	FRA	428866	–		○
	195	14,8	15	HGW HG517	KB	24130982 40422133	IP SP		● ●
	195	14,8	15	HGW HG517	KBK	49003728	–		○
	195	14,8	15	HGW HG650	KBK	49006012	–		○
200	195	14,8	15	PTFE B500	KF	24300215	IP		●
	195	19,5	20	PTFE B500	KF	24227497	–		○
	195	19,8	20	HGW HG517	KB	24350641	–		○
	195	19,8	20	HGW HG517	KBK	24380282	–		○
	195	19,8	20	HGW HG650	KBK	49019433	–		○
	195	24,5	25	HGW HG517	KB	24344891	–		○
	195	24,5	25	PTFE B500	KF	24306765	–		○
	195	29,5	30	HGW HG517	KBK	24380416	–		○
	195	34,5	35	HGW HG517	KBK	24380417	–		○
	196	25	25,4	PA 4201	EKF	99963 40421834	IP SP		● ●
	205	9,6	9,7	PTFE B500	KF	24301068	–		○
	205	14,8	15	HGW HG517	KB	24334874	–		○
210	205	14,8	15	HGW HG517	KBK	49002879	–		○
	205	14,8	15	HGW HG650	KBK	49037027	–		○
	205	14,8	15	PTFE B500	KF	24236228	IP		●
	205	34,5	35	HGW HG517	KBK	49001642	–		○
215	210	14,8	15	HGW HG517	KBK	24380699	–		○
	210	14,8	15	HGW HG650	KBK	49006014	–		○
	215	9,5	9,7	HGW HG650	KBK	49006015	–		○
220	215	9,6	9,7	PTFE B500	KF	24300216	–		○
	215	14,8	15	HGW HG517	KB	24300249 40422412	IP SP		● ●
	215	14,8	15	HGW HG650	KBK	49006016	–		○

d [mm]	D [mm]	H [mm]	L [mm]	Material	Design	Part No.	PU ¹⁾	US	EU
220	215	14,8	15	HGW HG517	KBK	49018312	-		○
	215	14,8	15	PTFE B500	KF	24203911	IP		●
	215	19,5	20	PTFE B500	KF	24340941	-		○
	215	24,5	25	HGW HG517	KB	24143328	-		○
	215	24,5	25	HGW HG517	KBK	49001458	-		○
	215	24,5	25	PTFE B500	KF	24290417	-		○
	215	34,5	25	HGW HG517	KBK	24379368	-		○
	216	30	30,5	PA 4201	EKF	95594	-		○
225	217	14,8	15	HGW HG517	KB	24339297	-		○
	217	24,5	25	HGW HG517	KB	24330488	-		○
	217	39,5	40	HGW HG517	KBK	530604	-		○
	220	9,6	9,7	PTFE B500	KF	24259939	-		○
	220	14,8	15	HGW HG517	KB	24212963	-		○
	220	14,8	15	HGW HG650	KBK	49037028	-		○
	220	14,8	15	PTFE B500	KF	24169846	-		○
	220	19,5	20	PTFE B500	KF	24260604	-		○
	220	24,5	25	HGW HG517	KB	24142350	-		○
	220	24,5	25	HGW HG517	KBK	24380539	-		○
	220	24,5	25	HGW HG650	KBK	49006017	IP		●
220	24,5	25	PTFE B500	KF	24298509	-		○	
230	222	14,8	15	HGW HG517	KB	24349607	-		○
	225	9,5	9,7	HGW HG517	KBK	24380706	-		○
	225	9,5	9,7	HGW HG650	KBK	49006018	-		○
	225	14,8	15	HGW HG517	KB	24334044	-		○
	225	14,8	15	HGW HG517	KBK	24372436	IP		●
	225	14,8	15	HGW HG650	KBK	49006019	IP		●
	225	14,8	15	PTFE B500	KF	24301085	IP		●
	225	19,5	20	PTFE B500	KF	24233567	-		○
	225	19,8	20	HGW HG517	KBK	24378298	-		○
225	34,5	35	HGW HG517	KBK	24378002	-		○	
240	235	14,8	15	HGW HG517	KB	24147696	IP		●
	235	14,8	15	HGW HG517	KBK	24380340	IP		●
	235	14,8	15	HGW HG650	KBK	49006021	-		○
	235	14,8	15	PTFE B500	KF	24167876	-		○
	235	19,8	20	HGW HG517	KB	24342277	-		○
	235	24,5	25	HGW HG517	KB	24349511	-		○
	235	24,5	25	HGW HG517	KBK	24379078	-		○
	235	24,5	25	HGW HG650	KBK	49006020	-		○
250	242	24,5	25	HGW HG517	KB	24299851	-		○
	242	39,5	40	HGW HG517	KBK	24378050	-		○
	245	9,5	9,7	HGW HG650	KBK	49006022	-		○
	245	9,6	9,7	PTFE B500	KF	24344263	-		○
	245	14,8	15	HGW HG517	KB	24130988	-		○
	245	14,8	15	HGW HG517	KBK	24378945	IP		●
	245	14,8	15	HGW HG650	KBK	49006023	-		○
	245	14,8	15	PTFE B500	KF	24300217	IP		●
	245	19,5	20	PTFE B500	KF	24338719	-		○
	245	24,5	25	HGW HG517	KB	24144514	-		○
	245	24,5	25	HGW HG517	KBK	49002401	-		○
255	250	14,8	15	HGW HG650	KBK	49030447	IP		●

d [mm]	D [mm]	H [mm]	L [mm]	Material	Design	Part No.	PU ¹⁾	US	EU
260	252	24,5	25	HGW HG517	KB	24299314	-		○
	252	39,5	40	HGW HG517	KBK	24378051	-		○
	255	14,8	15	HGW HG517	KB	24131488	-		○
	255	14,8	15	PTFE B500	KF	24300218	-		○
	255	24,5	25	HGW HG517	KBK	49002880	-		○
	255	24,5	25	HGW HG650	KBK	49006024	-		○
	255	24,5	25	PTFE B500	KF	24293567	-		○
	255	34,5	35	HGW HG517	KBK	529482	-		○
270	265	14,8	15	PTFE B500	KF	24238840	-		○
	265	24,5	25	HGW HG517	KBK	24379079	-		○
	265	24,5	25	PTFE B500	KF	24332002	-		○
	265	34,5	35	HGW HG517	KBK	49000025	-		○
272	39,5	40	HGW HG517	KBK	24378052	-		○	
275	14,8	15	HGW HG517	KB	24130991	IP		●	
275	14,8	15	HGW HG650	KBK	49006025	IP		●	
280	275	14,8	15	PTFE B500	KF	24300219	IP		●
	275	19,5	20	PTFE B500	KF	24153362	-		○
	275	24,5	25	HGW HG517	KB	24350273	-		○
	275	24,5	25	HGW HG650	KBK	49006026	-		○
	275	24,5	25	HGW HG517	KBK	527111	-		○
	275	24,5	25	PTFE B500	KF	24203990	-		○
	290	282	39,5	40	HGW HG517	KBK	528969	-	
295	14,8	15	HGW HG517	KB	24137782	IP		●	
300	295	14,8	15	HGW HG650	KBK	49079318	-		○
	295	14,8	15	PTFE B500	KF	24137238	-		○
	295	19,5	20	PTFE B500	KF	24328393	-		○
	295	24,5	25	HGW HG600	KBK	24378787	IP		●
	295	24,5	25	HGW HG650	KBK	49079319	-		○
	295	24,5	25	PTFE B500	KF	24134951	-		○
	295	34,5	35	HGW HG517	KBK	529484	-		○
	305	300	14,8	15	HGW HG600	KB	24142162	-	
305	300	14,8	15	PTFE B500	KF	24350592	-		○
310	302	39,5	40	HGW HG650	KBK	49079022	-		○
	302	39,6	40	HGW HG600	KBK	24378053	-		○
	305	14,8	15	HGW HG600	KBK	24380701	IP		●
	305	14,8	15	HGW HG650	KBK	49079011	-		○
	305	24,5	25	HGW HG600	KB	24353021	-		○
	305	24,5	25	PTFE B500	KF	24237194	-		○
	315	310	14,8	15	HGW HG600	KB	24351270	-	
312	19,5	20	PTFE B500	KF	24245663	-		○	
312	24,5	25	HGW HG600	KBK	24379044	-		○	
312	24,5	25	HGW HG650	KBK	49079023	-		○	
312	39,5	40	HGW HG650	KBK	49079025	-		○	
312	39,6	40	HGW HG600	KBK	24378054	-		○	
320	315	14,8	15	HGW HG600	KB	24130993	-		○
	315	14,8	15	PTFE B500	KF	24300220	-		○
	315	19,5	20	PTFE B500	KF	24231223	-		○
	315	24,5	25	HGW HG600	KB	24130994	-		○
	315	24,5	25	PTFE B500	KF	24300221	-		○
	315	29,5	30	HGW HG650	KBK	49079024	-		○

d [mm]	D [mm]	H [mm]	L [mm]	Material	Design	Part No.	PU ¹⁾	US	EU
330	322	24,5	25	HGW HG650	KBK	49079028	-		○
	322	29,5	30	HGW HG600	KBK	49004578	-		○
	322	29,5	30	HGW HG650	KBK	49079029	-		○
	325	14,5	15	HGW HG600	KB	24311172	-		○
	325	14,8	15	HGW HG650	KBK	49079026	-		○
	325	14,8	15	PTFE B500	KF	24296714	-		○
	325	24,5	25	HGW HG600	KB	24260227	-		○
	325	24,5	25	HGW HG600	KBK	24379256	-		○
	325	24,5	25	HGW HG650	KBK	49079027	-		○
	325	24,5	25	PTFE B500	KF	24314011	-		○
340	332	24,5	25	HGW HG600	KBK	24379045	-		○
	332	24,5	25	HGW HG650	KBK	49079030	-		○
	332	29,5	30	HGW HG650	KBK	49079031	-		○
	332	29,5	30	HGW HG600	KBK	528485	-		○
	335	14,8	15	HGW HG600	KB	24300250	-		○
	335	14,8	15	PTFE B500	KF	24300222	IP		●
	335	24,5	25	HGW HG600	KB	24300251	-		○
	335	24,5	25	PTFE B500	KF	24300223	-		○
350	342	24,5	25	HGW HG600	KB	24300936	-		○
	342	24,5	25	HGW HG650	KBK	49079042	-		○
	342	24,5	25	HGW HG600	KBK	530277	-		○
	342	39,5	40	HGW HG650	KBK	49079043	-		○
	342	39,5	40	HGW HG600	KBK	533359	-		○
	345	9,6	9,7	PTFE B500	KF	24316713	-		○
	345	14,8	15	HGW HG600	KB	24338667	-		○
	345	14,8	15	HGW HG650	KBK	49071520	-		○
	345	14,8	15	PTFE B500	KF	24234725	-		○
	345	24,5	25	HGW HG600	KB	24330500	-		○
355	350	24,5	25	HGW HG600	KB	24215447	-		○
	350	24,5	25	PTFE B500	KF	24336608	-		○
360	352	14,8	15	PTFE B500	KF	24266168	-		○
	352	24,5	25	HGW HG600	KB	24331493	-		○
	352	24,5	25	HGW HG650	KBK	49078976	-		○
	352	24,5	25	HGW HG600	KBK	531639	-		○
	352	24,5	25	PTFE B500	KF	24298511	-		○
	352	29,5	30	HGW HG600	KBK	24379154	-		○
	352	29,5	30	HGW HG650	KBK	49078977	-		○
	352	39,5	40	HGW HG600	KBK	24378056	-		○
	352	39,5	40	HGW HG650	KBK	49078978	-		○
	355	14,8	15	HGW HG600	KB	24130996	-		○
	355	14,8	15	PTFE B500	KF	24300224	IP		●
	355	24,5	25	HGW HG600	KB	24130997	-		○
	355	24,5	25	PTFE B500	KF	24164558	-		○
365	357	24,5	25	HGW HG650	KBK	49078979	-		○
	360	24,5	25	HGW HG650	KBK	49079044	-		○
375	367	24,5	25	HGW HG600	KBK	24379080	-		○
	367	24,5	25	HGW HG650	KBK	49078981	-		○
	370	24,5	25	HGW HG600	KBK	24378788	-		○
	370	24,5	25	HGW HG650	KBK	49078980	-		○
380	372	24,5	25	HGW HG600	KB	24294294	-		○

d [mm]	D [mm]	H [mm]	L [mm]	Material	Design	Part No.	PU ¹⁾	US	EU
	372	24,5	25	HGW HG650	KBK	49079052	-		○
	372	39,5	40	HGW HG600	KBK	24378057	-		○
	372	39,5	40	HGW HG650	KBK	49079053	-		○
380	375	14,8	15	HGW HG600	KB	24333136	-		○
	375	19,5	20	PTFE B500	KF	24257157	-		○
	375	24,5	25	HGW HG600	KB	24352259	-		○
	375	24,5	25	PTFE B500	KF	24299555	-		○
385	380	24,5	25	HGW HG650	KBK	49079054	-		○
	382	24,5	25	HGW HG600	KB	24344183	-		○
	382	24,5	25	PTFE B500	KF	24344184	-		○
	385	14,8	15	HGW HG600	KB	24338260	-		○
390	385	14,8	15	HGW HG650	KBK	49079055	-		○
	385	19,5	20	PTFE B500	KF	24248042	-		○
	385	24,5	25	HGW HG600	KB	24256744	-		○
	385	24,5	25	PTFE B500	KF	24215936	-		○
395	390	14,8	15	HGW HG650	KBK	49079056	-		○
	392	24,5	25	HGW HG600	KB	24307328	-		○
	392	24,5	25	PTFE B500	KF	24353170	-		○
	392	39,5	40	HGW HG600	KBK	24378058	-		○
	392	39,5	40	HGW HG650	KBK	49079057	-		○
400	395	14,8	15	HGW HG600	KB	24300252	-		○
	395	14,8	15	PTFE B500	KF	24300225	IP		●
	395	19,5	20	PTFE B500	KF	24241924	-		○
	395	24,5	25	HGW HG600	KB	24300253	IP		●
	395	24,5	25	PTFE B500	KF	24237477	-		○
	402	24,5	25	HGW HG600	KB	24263733	-		○
	402	39,5	40	HGW HG650	KBK	49063894	-		○
410	402	39,5	40	HGW HG600	KBK	531871	-		○
	405	14,8	15	HGW HG600	KB	24375939	-		○
	405	24,5	25	PTFE B500	KF	24292267	-		○
	412	24,5	25	HGW HG600	KBK	24379046	-		○
	412	24,5	25	HGW HG650	KBK	49079059	-		○
	412	39,5	40	HGW HG600	KBK	24378059	-		○
	412	39,5	40	HGW HG650	KBK	49079060	-		○
420	415	14,8	15	HGW HG600	KB	24259239	-		○
	415	19,5	20	PTFE B500	KF	24246829	-		○
	415	24,5	25	HGW HG600	KB	24261300	-		○
	415	24,5	25	HGW HG650	KBK	49079058	-		○
	415	24,5	25	PTFE B500	KF	24298563	-		○
	422	39,5	40	HGW HG600	KBK	49003308	-		○
	422	39,5	40	HGW HG650	KBK	49079061	-		○
430	425	14,8	15	HGW HG600	KB	24296973	-		○
	425	14,8	15	PTFE B500	KF	24274579	-		○
	425	24,5	25	HGW HG600	KB	24339689	-		○
	425	24,5	25	PTFE B500	KF	24356343	-		○
435	430	14,8	15	HGW HG600	KBK	49079062	-		○
	432	24,5	25	HGW HG600	KB	24289887	-		○
440	432	24,5	25	HGW HG600	KBK	49002762	-		○
	432	24,5	25	HGW HG650	KBK	49079063	-		○
	432	39,5	40	HGW HG650	KBK	49059766	-		○

d [mm]	D [mm]	H [mm]	L [mm]	Material	Design	Part No.	PU ¹⁾	US	EU
440	435	14,8	15	HGW HG600	KB	24338261	–		○
	435	14,8	15	PTFE B500	KF	24362293	–		○
	435	24,5	25	HGW HG600	KB	24368282	–		○
	435	24,5	25	PTFE B500	KF	24238056	–		○
441	433	39,5	40	HGW HG600	KBK	532899	–		○
445	440	24,5	25	PTFE B500	KF	24169312	–		○
450	442	24,5	25	HGW HG600	KB	24259181	–		○
	442	24,5	25	PTFE B500	KF	24336064	–		○
	442	39,5	40	HGW HG650	KBK	49079064	–		○
	445	14,5	15	HGW HG600	KB	24345674	–		○
	445	14,8	15	PTFE B500	KF	24295904	–		○
	445	19,5	20	PTFE B500	KF	24218386	–		○
	445	24,5	25	HGW HG600	KB	24250199	–		○
455	447	24,5	25	PTFE B500	KF	24339916	–		○
460	452	24,5	25	HGW HG650	KBK	49079132	–		○
	452	24,5	25	HGW HG600	KBK	24379348	IP		●
	452	24,5	25	HGW HG650	KBK	49079135	–		○
	452	39,5	40	HGW HG600	KBK	24379244	IP		●
	452	39,5	40	HGW HG650	KBK	49073281	–		○
	455	14,8	15	HGW HG600	KB	24341856	–		○
	455	14,8	15	HGW HG650	KBK	49079133	–		○
	455	14,8	15	PTFE B500	KF	24237495	–		○
	455	19,5	20	HGW HG600	KB	24341855	–		○
	455	19,5	20	PTFE B500	KF	24216297	–		○
	455	24,5	25	HGW HG600	KB	24339270	–		○
465	460	39,5	40	HGW HG650	KBK	49079134	–		○
	460	24,5	25	PTFE B500	KF	24258000	–		○
470	465	24,5	25	HGW HG600	KB	24294215	–		○
	465	24,5	25	HGW HG650	KBK	49079137	–		○
475	470	24,5	25	HGW HG650	KBK	49079138	–		○
480	472	24,5	25	HGW HG600	KB	24331494	–		○
	472	24,5	25	PTFE B500	KF	24298510	–		○
	472	39,5	40	HGW HG600	KBK	24378060	–		○
	472	39,5	40	HGW HG650	KBK	49063895	–		○
	475	24,5	25	HGW HG600	KB	24250198	–		○
	475	24,5	25	HGW HG600	KBK	24378805	IP		●
	475	24,5	25	HGW HG650	KBK	49079139	–		○
490	475	24,5	25	PTFE B500	KF	24250182	–		○
	482	24,5	25	HGW HG600	KB	24262693	–		○
	492	14,8	15	PTFE B500	KF	24344266	–		○
	492	24,5	25	HGW HG600	KB	24294986	–		○
	492	24,5	25	HGW HG600	KBK	49002908	–		○
	492	24,5	25	HGW HG650	KBK	49079140	–		○
	492	24,5	25	PTFE B500	KF	24261230	–		○
	492	39,5	40	HGW HG650	KBK	49079141	–		○
	492	39,5	40	HGW HG600	KBK	531874	–		○
	495	14,8	15	PTFE B500	KF	24274580	–		○
	495	24,5	25	HGW HG600	KB	24302073	–		○
495	24,5	25	PTFE B500	KF	24263977	–		○	

d [mm]	D [mm]	H [mm]	L [mm]	Material	Design	Part No.	PU ¹⁾	US	EU
508	500	24,5	25	HGW HG600	KB	24360120	-		○
	502	24,5	25	HGW HG650	KBK	49079144	-		○
	505	14,8	15	PTFE B500	KF	24291161	-		○
510	505	24,5	25	HGW HG600	KB	24359433	-		○
	505	24,5	25	HGW HG650	KBK	49079143	-		○
	505	24,5	25	PTFE B500	KF	24360396	-		○
	515	14,8	15	HGW HG600	KB	24274934	-		○
520	515	19,5	20	PTFE B500	KF	24230163	-		○
	515	39,5	40	HGW HG650	KBK	49079145	-		○
	522	24,5	25	HGW HG600	KB	24290173	-		○
	522	24,5	25	HGW HG650	KBK	49079146	-		○
530	522	24,5	25	HGW HG600	KBK	530276	-		○
	522	39,5	40	HGW HG650	KBK	49079147	-		○
	525	14,8	15	HGW HG600	KB	24294259	-		○
	525	14,8	15	PTFE B500	KF	24258834	-		○
	532	24,5	25	HGW HG600	KB	24299558	-		○
	532	24,5	25	HGW HG600	KBK	24379047	-		○
	532	24,5	25	HGW HG650	KBK	49079149	-		○
	532	39,5	40	HGW HG650	KBK	49079150	-		○
540	535	14,8	15	HGW HG600	KB	24359735	-		○
	535	24,5	25	HGW HG600	KB	24359576	-		○
	535	24,5	25	HGW HG600	KBK	24378806	IP		●
	535	24,5	25	HGW HG650	KBK	49079148	-		○
	535	24,5	25	PTFE B500	KF	24339008	-		○
545	540	24,5	25	PTFE B500	KF	24250579	-		○
	545	24,5	25	HGW HG600	KB	24302134	-		○
550	545	24,5	25	HGW HG650	KBK	49079152	-		○
	545	24,5	25	PTFE B500	KF	24257339	-		○
	552	24,5	25	HGW HG600	KB	24332680	-		○
	552	24,5	25	HGW HG600	KBK	24377622	-		○
	552	24,5	25	PTFE B500	KF	24359710	-		○
560	552	39,5	40	HGW HG650	KBK	49079153	-		○
	555	14,8	15	HGW HG600	KB	24185838	-		○
	555	14,8	15	PTFE B500	KF	24351466	-		○
	555	24,5	25	HGW HG600	KB	24336491	-		○
	555	24,5	25	PTFE B500	KF	24269185	-		○
565	557	39,5	40	HGW HG650	KBK	49079154	-		○
	562	14,8	15	PTFE B500	KF	24352095	-		○
570	562	24,5	25	PTFE B500	KF	24351060	-		○
	565	24,5	25	HGW HG600	KB	24351059	-		○
575	570	24,5	25	HGW HG600	KB	24289831	-		○
	572	14,8	15	PTFE B500	KF	24344267	-		○
	572	19,8	20	HGW HG650	KBK	49079155	-		○
	572	24,5	25	HGW HG600	KB	24298400	-		○
580	572	24,5	25	HGW HG600	KBK	24379048	-		○
	572	39,5	40	HGW HG650	KBK	49069801	-		○
	575	24,5	25	HGW HG600	KB	24345487	-		○
	575	24,5	25	PTFE B500	KF	24339500	-		○
590	585	24,5	25	HGW HG650	KBK	49079157	-		○
600	592	24,5	25	HGW HG600	KB	24275141	-		○

d [mm]	D [mm]	H [mm]	L [mm]	Material	Design	Part No.	PU ¹⁾	US	EU
600	592	24,5	25	HGW HG600	KBK	24377999	-		○
	592	24,5	25	HGW HG650	KBK	49079066	-		○
	592	24,5	25	PTFE B500	KF	24275000	-		○
	592	39,5	40	HGW HG600	KBK	24379323	-		○
	592	39,5	40	HGW HG650	KBK	49079067	-		○
	595	14,8	15	HGW HG600	KB	24274937	-		○
	595	14,8	15	PTFE B500	KF	24234910	-		○
	595	19,5	20	PTFE B500	KF	24329803	-		○
	595	24,5	25	HGW HG600	KB	24362837	-		○
	595	24,5	25	HGW HG600	KBK	24378808	-		○
	595	24,5	25	HGW HG650	KBK	49079065	-		○
	595	24,5	25	PTFE B500	KF	24234912	-		○
610	602	24,5	25	HGW HG600	KB	24344890	-		○
	602	39,5	40	HGW HG650	KBK	49079068	-		○
620	612	24,5	25	HGW HG600	KB	24291804	-		○
	612	24,5	25	HGW HG600	KBK	49004662	-		○
	612	24,5	25	HGW HG650	KBK	49079069	-		○
	615	24,5	25	HGW HG600	KB	24309946	-		○
625	620	9,6	9,7	HGW HG600	KB	24351384	-		○
	620	14,8	15	PTFE B500	KF	24352637	-		○
630	622	24,5	25	HGW HG600	KB	24340041	-		○
	622	24,5	25	HGW HG600	KBK	24379049	-		○
	622	39,5	40	HGW HG600	KBK	49002675	-		○
	622	39,5	40	HGW HG650	KBK	49062927	-		○
	625	14,8	15	PTFE B500	KF	24161640	-		○
	625	24,5	25	HGW HG650	KBK	49079070	-		○
	625	24,5	25	PTFE B500	KF	24263466	-		○
640	632	24,5	25	HGW HG600	KB	24275165	-		○
	632	24,5	25	HGW HG650	KBK	49079071	-		○
	632	24,5	25	HGW HG600	KBK	531869	-		○
	632	24,5	25	PTFE B500	KF	24275167	-		○
650	642	24,5	25	HGW HG600	KB	24358966	-		○
	642	24,5	25	PTFE B500	KF	24358984	-		○
	642	39,5	40	HGW HG650	KBK	49080102	-		○
	645	24,5	25	PTFE B500	KF	24239182	-		○
655	650	24,5	25	PTFE B500	KF	24231930	-		○
660	652	24,5	25	HGW HG600	KB	24315102	-		○
	652	24,5	25	HGW HG650	KBK	49079073	-		○
	652	39,5	40	HGW HG600	KBK	49058961	-		○
	655	24,5	25	HGW HG650	KBK	49079072	-		○
665	660	24,5	25	PTFE B500	KF	24336379	-		○
680	672	14,8	15	PTFE B500	KF	24344269	-		○
	672	24,5	25	HGW HG600	KB	24298436	-		○
	672	24,5	25	HGW HG650	KBK	49079075	-		○
	672	24,5	25	HGW HG600	KBK	527133	-		○
	672	24,5	25	PTFE B500	KF	24298430	-		○
	672	39,5	40	HGW HG600	KBK	49004923	-		○
	672	39,5	40	HGW HG650	KBK	49079076	-		○
	675	24,5	25	HGW HG600	KB	24344258	-		○
	675	24,5	25	HGW HG650	KBK	49079074	-		○











d [mm]	D [mm]	H [mm]	L [mm]	Material	Design	Part No.	PU ¹⁾	US	EU
680	675	24,5	25	HGW HG600	KBK	526191	IP		●
	675	24,5	25	PTFE B500	KF	24357190	-		○
690	682	24,5	25	PTFE B500	KF	24361405	-		○
	685	14,8	15	HGW HG650	KBK	49079077	-		○
700	692	24,5	25	HGW HG600	KB	24314495	-		○
	692	24,5	25	HGW HG600	KBK	24376187	-		○
	692	24,5	25	PTFE B500	KF	24349705	-		○
	692	34,5	35	HGW HG600	KBK	49003965	-		○
	692	34,5	35	HGW HG650	KBK	49079078	-		○
	695	14,8	15	HGW HG600	KB	24275184	-		○
	695	14,8	15	PTFE B500	KF	24275183	-		○
	695	24,5	25	PTFE B500	KF	24338859	-		○
	695	39,5	40	HGW HG650	KBK	49079079	-		○
	710	702	24,5	25	HGW HG600	KB	24340042	-	
702		39,5	40	HGW HG600	KBK	49002676	-		○
702		39,5	40	HGW HG650	KBK	49062930	-		○
705		14,8	15	HGW HG600	KB	24287808	-		○
705		19,5	20	PTFE B500	KF	24162128	-		○
720	712	19,5	20	PTFE B500	KF	24226253	-		○
	712	24,5	25	PTFE B500	KF	24355876	-		○
	715	14,8	15	HGW HG600	KB	24302590	-		○
	715	14,8	15	PTFE B500	KF	24348252	-		○
	715	19,5	20	PTFE B500	KF	24291417	-		○
	715	24,5	25	HGW HG600	KB	24250197	-		○
	715	24,5	25	PTFE B500	KF	24240256	-		○
725	720	24,5	25	PTFE B500	KF	24340198	-		○
730	722	24,5	25	HGW HG600	KB	24269481	-		○
	722	39,5	40	HGW HG650	KBK	49073087	-		○
740	732	24,5	25	HGW HG600	KB	24263271	-		○
	732	24,5	25	HGW HG600	KBK	49079080	-		○
	732	34,5	35	HGW HG600	KBK	24378498	-		○
	732	34,5	35	HGW HG650	KBK	49079081	-		○
750	742	24,5	25	HGW HG600	KB	24293965	-		○
	742	24,5	25	HGW HG650	KBK	49079082	-		○
	742	24,5	25	PTFE B500	KF	24293964	-		○
760	752	14,8	15	PTFE B500	KF	24216171	-		○
	752	19,5	20	PTFE B500	KF	24216170	-		○
	752	39,5	40	HGW HG600	KBK	24379321	-		○
	752	39,5	40	HGW HG650	KBK	49079049	-		○
	755	24,5	25	PTFE B500	KF	24162992	-		○
770	762	14,8	15	PTFE B500	KF	24344270	-		○
	765	24,5	25	HGW HG600	KB	24344259	-		○
775	770	24,5	25	PTFE B500	KF	24245794	-		○
780	775	14,8	15	HGW HG600	KB	24358669	-		○
	775	14,8	15	PTFE B500	KF	24358668	-		○
800	792	14,8	15	PTFE B500	KF	24348279	-		○
	792	19,8	20	HGW HG600	KBK	49000238	-		○
	792	19,8	20	HGW HG650	KBK	49079050	-		○
	792	24,5	25	HGW HG600	KB	24243178	-		○
	792	24,5	25	HGW HG600	KBK	24378000	-		○

d [mm]	D [mm]	H [mm]	L [mm]	Material	Design	Part No.	PU ¹⁾	US	EU
800	792	24,5	25	HGW HG650	KBK	49079051	-		○
	792	24,5	25	PTFE B500	KF	24243176	-		○
	795	14,8	15	HGW HG600	KB	24257374	-		○
813,3	805,3	24,5	25	HGW HG600	KB	24346654	-		○
820	812	24,5	25	HGW HG600	KB	24341040	-		○
	812	24,5	25	PTFE B500	KF	24341042	-		○
830	822	24,5	25	HGW HG600	KB	24295835	-		○
	822	24,5	25	HGW HG650	KBK	49079122	-		○
	822	24,5	25	PTFE B500	KF	24354856	-		○
	825	24,5	25	PTFE B500	KF	24353637	-		○
840	832	24,5	25	HGW HG650	KBK	49079123	-		○
850	842	24,5	25	HGW HG600	KB	24293544	-		○
	842	24,5	25	HGW HG650	KBK	49079124	-		○
	842	24,5	25	HGW HG600	KBK	531637	-		○
	842	24,5	25	PTFE B500	KF	24300402	-		○
	845	19,5	20	PTFE B500	KF	24265124	-		○
	845	24,5	25	PTFE B500	KF	24163721	-		○
865	857	19,8	20	HGW HG650	KBK	49079125	-		○
	857	19,8	20	HGW HG600	KBK	531678	-		○
	857	39,5	40	HGW HG600	KBK	49003031	-		○
	857	39,5	40	HGW HG650	KBK	49079126	-		○
870	862	24,5	25	HGW HG600	KB	24359019	-		○
878	870	24,5	25	HGW HG600	KB	24358857	-		○
880	872	24,5	25	HGW HG600	KB	24339269	-		○
900	892	19,5	20	PTFE B500	KF	24238053	-		○
	892	24,5	25	HGW HG600	KB	24344382	-		○
	892	24,5	25	PTFE B500	KF	24344380	-		○
	892	39,5	40	HGW HG650	KBK	49079127	-		○
	895	24,5	25	PTFE B500	KF	24162990	-		○
914,4	906,4	24,5	25	HGW HG600	KB	24358613	-		○
920	915	24,5	25	PTFE B500	KF	24258318	-		○
940	932	24,5	25	PTFE B500	KF	24352164	-		○
	935	24,5	25	PTFE B500	KF	24163720	-		○
950	942	24,5	25	HGW HG600	KBK	24379050	IP		●
	942	24,5	25	HGW HG650	KBK	49079128	-		○
	942	39,5	40	HGW HG650	KBK	49079129	-		○
965	957	14,8	15	PTFE B500	KF	24263608	-		○
	957	24,5	25	HGW HG600	KB	24263886	-		○
	957	24,5	25	HGW HG600	KBK	49003044	-		○
	957	24,5	25	HGW HG650	KBK	49079130	-		○
	957	24,5	25	PTFE B500	KF	24295215	-		○
965,2	957,2	24,5	25	HGW HG600	KB	24331519	-		○
1000	992	39,5	40	HGW HG650	KBK	49079131	-		○
	995	24,5	25	PTFE B500	KF	24162989	-		○
1050	1042	24,4	25	HGW HG600	KB	24257239	-		○
	1042	24,5	25	HGW HG600	KBK	24376188	-		○
	1042	24,5	25	PTFE B500	KF	24257242	-		○
	1042	39,5	40	HGW HG650	KBK	49063919	-		○
	1045	24,5	25	PTFE B500	KF	24227975	-		○
1100	1092	24,5	25	PTFE B500	KF	24269869	-		○

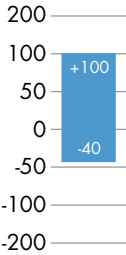
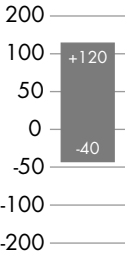
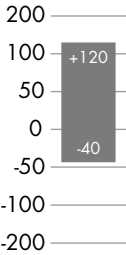
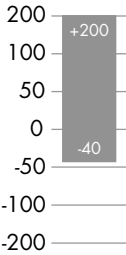
d [mm]	D [mm]	H [mm]	L [mm]	Material	Design	Part No.	PU ¹⁾	US	EU
1100	1092	39,5	40	HGW HG650	KBK	49079161	–	○	
1150	1142	39,5	40	HGW HG650	KBK	49079162	–	○	
1160	1152	39,5	40	HGW HG600	KBK	49002142	–	○	
1180	1172	24,5	25	PTFE B500	KF	24361406	–	○	
	1192	14,8	15	PTFE B500	KF	24359446	–	○	
1200	1192	24,5	25	HGW HG600	KBK	533290	–	○	
	1192	39,5	40	HGW HG650	KBK	49066672	–	○	
1250	1242	24,5	25	HGW HG600	KBK	530020	IP	●	
	1242	39,5	40	HGW HG650	KBK	49079163	–	○	
	1292	24,5	25	PTFE B500	KF	24357283	–	○	
1300	1292	39,5	40	HGW HG650	KBK	49079108	–	○	
1350	1342	39,5	40	HGW HG650	KBK	49079109	–	○	
1400	1392	39,5	40	HGW HG650	KBK	49079110	–	○	
	1442	39,5	40	HGW HG650	KBK	49079111	–	○	
1450	1442	39,5	40	HGW HG600	KBK	531903	–	○	
1500	1492	39,5	40	HGW HG650	KBK	49066355	–	○	

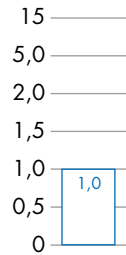
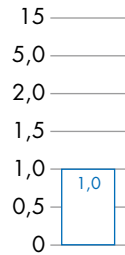
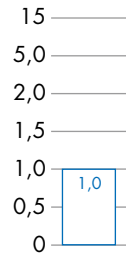
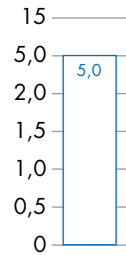
L [mm]	S [mm]	Material	Design	Part No.	PU ¹⁾	US	EU
8	2	PTFE O5ZF	RYT	GZ1291-V0	–	○	
10	2	PTFE O5ZF	RYT	GZ1292-V0	–	○	
15	2,5	PTFE O5ZF	RYT	GZ1293-V0	–	○	
20	2,5	PTFE O5ZF	RYT	GZ1294-V0	–	○	
25	2,5	PTFE O5ZF	RYT	GZ1295-V0	–	○	
30	2,5	PTFE O5ZF	RYT	GZ1296-V0	–	○	
35	2,5	PTFE O5ZF	RYT	GZ1297-V0	–	○	
40	2,5	PTFE O5ZF	RYT	GZ1298-V0	–	○	
45	2,5	PTFE O5ZF	RYT	GZ1299-V0	–	○	
50	3	PTFE O5ZF	RYT	GZ1300-V0	–	○	
55	3	PTFE O5ZF	RYT	GZ1301-V0	–	○	
60	3	PTFE O5ZF	RYT	GZ1302-V0	–	○	
70	3	PTFE O5ZF	RYT	GZ1303-V0	–	○	

L [mm]	S [mm]	Material	Design	Part No.	PU ¹⁾	US	EU
8	2,5	PTFE B500	KF	24226174	–	○	
9,7	2,5	PTFE B500	KF	24102775	–	○	
10	2,5	PTFE B500	KF	24102563	–	○	
12	2,5	PTFE B500	KF	24099191	–	○	
15	2,5	PTFE B500	KF	24102564	–	○	
20	2,5	PTFE B500	KF	24076217	–	○	
25	2,5	PTFE B500	KF	24107955	–	○	
15	4	PTFE B500	KF	24160019	–	○	
20	4	PTFE B500	KF	24238052	–	○	
25	4	PTFE B500	KF	24148093	–	○	

Type	FRI	SBK	SB	SF
Standard	ISO	ISO	ISO	ISO
Shape				
Compound	Polyamide PA4112	Fabric base laminate HG517 HG650	Fabric base laminate HG517 HG650 HG600	PTFE B500
				
				
Applications				

Bitte beachten Sie unsere allgemeinen Konstruktionshinweise in → Technisches Handbuch

Daha detaylı montaj bilgisi için → Bkz. Technical Manual

W celu zaznajomienia się z ogólnymi uwagami proszę skorzystać z Instrukcji

Общие технические рекомендации см. → Техническое руководство

STANGENFÜHRUNGSRINGE | ROD YATAKLAMA ELEMANLARI PROWADNICA TŁOCZYSKA | ШТОКОВЫЕ НАПРАВЛЯЮЩИЕ КОЛЬЦА

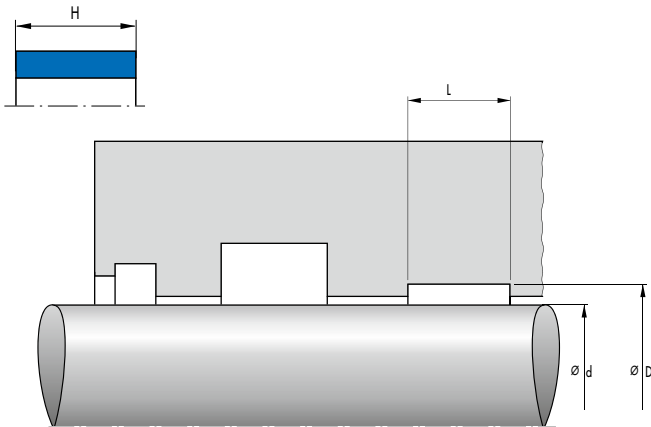

Wenn Sie Ihre Dichtung nicht finden können – Ihre Lösung auf Seite 12
 Aradığınız ürünü bulamadığınız takdirde – çözümünüz sayfa 12
 Jeżeli nie możecie Państwo znaleźć uszczelki – rozwiązanie znajduje się na stronie 12
 Вы не можете подобрать необходимое уплотнение? – Решение на странице 12

1) IP = Industriepackung | Endüstriyel ambalaj | Opakowania przemysłowe | Производственная тара
 SP = Einzelpackung | Tek bir Paket | Pojedyncze opakowanie | Single Pack

● Auf Lager | Stoklarda mevcuttur | Dostępne w magazynie | Имеется в наличии на складе
 ○ Auf Anfrage | Talep üzerine | Na zapytanie | По запросу

d [mm]	D [mm]	H [mm]	L [mm]	Material	Design	Part No.	PU ¹⁾	US	EU
20	23	5,5	5,6	HGW HG517	SB	24269402	–		○
	23,1	3,9	4	PA 4112	FRI	434219 40421996	IP SP		● ●
22	25	5,5	5,6	HGW HG517	SB	24288276	–		○
	28	5,5	5,6	HGW HG517	SB	24226044 40422308	IP SP		● ●
25	28	5,5	5,6	PTFE B500	SF	24300101	IP		●
	28,1	3,9	4	PA 4112	FRI	434220 40421997	IP SP		● ●
28	30	9,5	9,7	HGW HG517	SBK	533551	–		○
	31	5,5	5,6	HGW HG517	SB	24226045	–	○	○
	31	5,5	5,6	HGW HG517	SBK	24375389	–		○
30	31	5,5	5,6	PTFE B500	SF	24300102	IP		●
	33	5,5	5,6	HGW HG517	SB	24226046 40422309	IP SP		● ●
	33,1	3,9	4	PA 4112	FRI	434221 40421998	IP SP		● ●
32	35	9,5	9,7	HGW HG650	SBK	49006029	–		○
	35	5,5	5,6	HGW HG517	SB	24226047	IP		●
	35,1	3,9	4	PA 4112	FRI	434222 40421999	IP SP		● ●
35	37	9,6	9,7	HGW HG517	SB	24306287	–		○
	37	9,6	9,7	PTFE B500	SF	24294062	–		○
	38	5,5	5,6	HGW HG517	SB	24226048	–		○
36	38	5,5	5,6	PTFE B500	SF	24300105	–		○
	39	5,5	5,6	HGW HG517	SB	24226049	–		○
	41	5,4	5,6	PA 4112	FRI	426463 40421967	IP SP		● ●
38	41	5,5	5,6	PTFE B500	SF	24165260	–		○
	41	9,6	9,7	HGW HG517	SB	24131021 40422134	IP SP		● ●
40	43	5,5	5,6	HGW HG517	SB	24226050	–		○
40	43	5,5	5,6	HGW HG517	SB	24226052 40422310	IP SP		● ●

d [mm]	D [mm]	H [mm]	L [mm]	Material	Design	Part No.	PU ¹⁾	US	EU
40	45	5,4	5,6	PA 4112	FRI	426464 40421968	IP SP		● ●
	45	9,5	9,7	HGW HG650	SBK	49006608	IP		●
	45	9,6	9,7	HGW HG517	SB	24131024 40422135	IP SP		● ●
	45	9,6	9,7	HGW HG517	SBK	24370469 40422500	IP SP		● ●
	45	9,6	9,7	PTFE B500	SF	24216883	IP		●
	45	14,8	15	HGW HG650	SBK	49006206	–		○
42	47	5,5	5,6	HGW HG517	SB	24131026	–		○
	47	5,5	5,6	PTFE B500	SF	24300109	–		○
44	49	9,6	9,7	PTFE B500	SF	24333828	–		○
45	50	5,4	5,6	PA 4112	FRI	426465 40421969	IP SP		● ●
	50	5,5	5,6	HGW HG517	SB	24131029 40422136	IP SP		● ●
	50	5,5	5,6	PTFE B500	SF	24300110	IP		●
	50	9,5	9,7	HGW HG650	SBK	49006207	–		○
	50	9,6	9,7	HGW HG517	SB	24131030 40422137	IP SP		● ●
	50	9,6	9,7	HGW HG517	SBK	24375662 40422505	IP SP		● ●
	50	9,6	9,7	PTFE B500	SF	24266350	IP		●
	50	14,8	15	HGW HG517	SBK	24380507	–		○
50	50	14,8	15	PTFE B500	SF	24311361	–		○
	55	5,5	5,6	HGW HG517	SB	24131032	IP		●
	55	5,5	5,6	PTFE B500	SF	24110082	–		○
	55	9,5	9,7	PA 4112	FRI	428805 40421974	IP SP		● ●
	55	9,5	9,7	HGW HG650	SBK	49001908	–		○
	55	9,6	9,7	HGW HG517	SB	24131033 40422138	IP SP		● ●
	55	9,6	9,7	HGW HG517	SBK	24367539 40422497	IP SP		● ●
	55	9,6	9,7	PTFE B500	SF	24169558	IP		●
	55	14,8	15	HGW HG517	SB	24237133	–		○
	55	14,8	15	HGW HG650	SBK	49006209	–		○
55	55	14,8	15	PTFE B500	SF	24203345	–		○
	60	9,5	9,7	HGW HG650	SBK	49001907	–		○
	60	9,6	9,7	HGW HG517	SB	24131036 40422139	IP SP		● ●
	60	9,6	9,7	HGW HG517	SBK	524832	–		○
	60	9,6	9,7	PTFE B500	SF	24160646	IP		●
	60	14,8	15	HGW HG517	SB	24275189	–		○
	60	14,8	15	HGW HG517	SBK	24380889	–		○
56	60	14,8	15	HGW HG650	SBK	49006210	IP		●
	60	14,8	15	PTFE B500	SF	24275190	–		○
	61	5,5	5,6	HGW HG517	SB	24131038	–		○
	61	5,5	5,6	PTFE B500	SF	24300111	–		○
	61	9,5	9,7	PA 4112	FRI	429273 40421982	IP SP		● ●
	61	9,6	9,7	HGW HG517	SB	24131039	–		○
	61	9,6	9,7	PTFE B500	SF	24245671	IP		●
	61	14,8	15	HGW HG517	SB	24290092	–		○
61	14,8	15	PTFE B500	SF	24316593	–		○	

d [mm]	D [mm]	H [mm]	L [mm]	Material	Design	Part No.	PU ¹⁾	US	EU
58	63	9,6	9,7	PTFE B500	SF	24333829	–		○
60	65	5,5	5,6	HGW HG517	SB	24131041	–		○
	65	9,5	9,7	PA 4112	FRI	429318 40421983	IP SP		● ●
	65	9,5	9,7	HGW HG650	SBK	49002920	–		○
	65	9,6	9,7	HGW HG517	SB	24131042	IP		●
	65	9,6	9,7	PTFE B500	SF	24165598	IP		●
	65	14,8	15	HGW HG517	SB	24194850	–		○
	65	14,8	15	HGW HG517	SBK	24375946 40422508	IP SP		● ●
	65	14,8	15	HGW HG650	SBK	49002006	–		○
	65	14,8	15	PTFE B500	SF	24203612	–		○
	65	19,8	20	HGW HG517	SB	24237268	–		○
63	68	14,8	15	HGW HG650	SBK	49005283	–		○
	68	9,5	9,7	PA 4112	FRI	432260 40421986	IP SP		● ●
	68	9,5	9,7	HGW HG517	SBK	49000672	–		○
	68	9,6	9,7	HGW HG517	SB	24131045	–		○
	68	9,6	9,7	PTFE B500	SF	24300114	IP		●
65	68	14,8	15	PTFE B500	SF	24275191	–		○
	70	9,5	9,7	PA 4112	FRI	432261	–		○
	70	9,5	9,7	HGW HG517	SBK	24367540	–		○
	70	9,5	9,7	HGW HG650	SBK	49006214	–		○
	70	9,6	9,7	HGW HG517	SB	24131048 40422140	IP SP		● ●
	70	9,6	9,7	PTFE B500	SF	24300116	IP		●
	70	14,8	15	HGW HG517	SB	24341762	–		○
	70	14,8	15	HGW HG517	SBK	24380160	–		○
70	70	14,8	15	HGW HG650	SBK	49006215	–		○
	73	9,6	9,7	PTFE B500	SF	24332153	–		○
	75	9,5	9,7	PA 4112	FRI	432262 40421987	IP SP		● ●
	75	9,5	9,7	HGW HG517	SBK	24367541 40422498	IP SP		● ●
	75	9,5	9,7	HGW HG650	SBK	49006216	–		○
	75	9,6	9,7	HGW HG517	SB	24131051 40422141	IP SP		● ●
	75	9,6	9,7	PTFE B500	SF	24300118	IP		●
	75	14,8	15	HGW HG517	SB	24180724	IP		●
75	75	14,8	15	HGW HG650	SBK	49002007	–		○
	80	9,5	9,7	HGW HG650	SBK	49006217	–		○
	80	9,5	9,7	HGW HG517	SBK	528479	–		○
	80	9,6	9,7	HGW HG517	SB	24131054 40422142	IP SP		● ●
	80	9,6	9,7	PTFE B500	SF	24300120	IP		●
	80	14,8	15	HGW HG517	SB	24351115	–		○
	80	14,8	15	HGW HG650	SBK	49006218	–		○
	80	14,8	15	HGW HG517	SBK	529802	–		○
	80	14,8	15	PTFE B500	SF	24244742	–		○
	80	24,5	25	HGW HG650	SBK	49018480	–		○
78	83	14,8	15	HGW HG517	SBK	49004925	–		○
	83	19,8	20	HGW HG517	SBK	49002107	–		○
80	85	9,5	9,7	PA 4112	FRI	432264 40421988	IP SP		● ●

d [mm]	D [mm]	H [mm]	L [mm]	Material	Design	Part No.	PU ¹⁾	US	EU
80	85	9,5	9,7	HGW HG517	SBK	24380101 40422517	IP SP		● ●
	85	9,5	9,7	HGW HG650	SBK	49006219	-		○
	85	9,6	9,7	HGW HG517	SB	24131056 40422143	IP SP		● ●
	85	9,6	9,7	PTFE B500	SF	24300122	IP		●
	85	14,8	15	HGW HG517	SB	24138557	IP		●
	85	14,8	15	HGW HG517	SBK	24370470 40422501	IP SP		● ●
	85	14,8	15	HGW HG650	SBK	49002010	-		○
	85	14,8	15	PTFE B500	SF	24266958	IP		●
	85	24,5	25	HGW HG517	SB	24345442	-		○
	85	24,5	25	HGW HG517	SBK	24373284 40422502	IP SP		● ●
	85	24,5	25	HGW HG650	SBK	49030314	-		○
	85	24,5	25	PTFE B500	SF	24265250	-		○
	88	14,8	15	HGW HG517	SBK	49004810	-		○
	85	90	9,5	9,7	HGW HG650	SBK	49006220	-	
90		9,6	9,7	HGW HG517	SB	24131058 40422144	IP SP		● ●
90		9,6	9,7	PTFE B500	SF	24167352	IP		●
90		14,8	15	HGW HG517	SB	24346624 40422474	IP SP		● ●
90		14,8	15	HGW HG517	SBK	24380161	-		○
90		14,8	15	HGW HG650	SBK	49006221	-		○
90		14,8	15	PTFE B500	SF	24244741	-		○
90		24,5	25	HGW HG650	SBK	49018481	-		○
90	95	9,5	9,7	PA 4112	FRI	432266 40421989	IP SP		● ●
	95	9,5	9,7	HGW HG650	SBK	49006222	-		○
	95	9,6	9,7	HGW HG517	SB	24131060 40422145	IP SP		● ●
	95	9,6	9,7	PTFE B500	SF	24300125	IP		●
	95	14,8	15	HGW HG517	SB	24232557	IP		●
	95	14,8	15	HGW HG517	SBK	24379371	-		○
	95	14,8	15	PTFE B500	SF	24291194	IP		●
	95	24,5	25	HGW HG650	SBK	49006223	-		○
	95	24,5	25	HGW HG517	SBK	528119	IP		●
	95	34,5	35	HGW HG517	SBK	24380556	-		○
	98	19,8	20	HGW HG517	SBK	24359046	-		○
93	98	19,8	20	HGW HG517	SBK	49002108	-		○
95	100	9,5	9,7	HGW HG650	SBK	49006224	-		○
	100	9,6	9,7	HGW HG517	SB	24148244 40422152	IP SP		● ●
	100	9,6	9,7	PTFE B500	SF	24300127	-		○
	100	14,8	15	HGW HG517	SBK	24379355	-		○
	100	14,8	15	HGW HG650	SBK	49006225	-		○
100	105	9,5	9,7	PA 4112	FRI	432267 40421990	IP SP		● ●
	105	9,5	9,7	HGW HG650	SBK	49006226	-		○
	105	9,6	9,7	HGW HG517	SB	24131062 40422146	IP SP		● ●
	105	9,6	9,7	PTFE B500	SF	24300129	IP		●
	105	14,8	15	HGW HG517	SB	24174684 40422153	IP SP		● ●

d [mm]	D [mm]	H [mm]	L [mm]	Material	Design	Part No.	PU ¹⁾	US	EU	
100	105	14,8	15	HGW HG517	SBK	24380162 40422518	IP SP		● ●	
	105	14,8	15	HGW HG650	SBK	49006227	-		○	
	105	14,8	15	PTFE B500	SF	24250627	-		○	
	105	19,5	20	PTFE B500	SF	24260605	-		○	
	105	19,8	20	HGW HG517	SBK	24379370 40422516	IP SP		● ●	
	105	24,5	25	HGW HG517	SB	24294287	-		○	
	105	24,5	25	PTFE B500	SF	24342265	-		○	
	108	14,8	15	PTFE B500	SF	24327233	-		○	
	108	24,5	25	HGW HG517	SBK	49005018	-		○	
105	110	9,5	9,7	HGW HG650	SBK	49006228	-		○	
	110	9,6	9,7	HGW HG517	SB	24197459	-		○	
	110	9,6	9,7	PTFE B500	SF	24300131	IP		●	
	110	14,8	15	HGW HG517	SB	24191184	-		○	
	110	14,8	15	HGW HG650	SBK	49006229	-		○	
110	115	9,5	9,7	HGW HG650	SBK	49006230	-		○	
	115	9,6	9,7	PTFE B500	SF	24300133	IP		●	
	115	14,8	15	HGW HG517	SB	24193285	-		○	
	115	14,8	15	HGW HG650	SBK	49006231	-		○	
	115	14,8	15	PTFE B500	SF	24293684	IP		●	
	115	19,5	20	PTFE B500	SF	24166931	-		○	
	115	19,8	20	HGW HG517	SBK	24379369	-		○	
	115	24,5	25	HGW HG517	SB	24306764	-		○	
	115	24,5	25	HGW HG517	SBK	24377187 40422512	IP SP		● ●	
	115	24,5	25	PTFE B500	SF	24292915	-		○	
	118	14,8	15	HGW HG517	SBK	24358242	-		○	
	118	14,8	15	PTFE B500	SF	24327234	-		○	
	118	39,5	40	HGW HG650	SBK	49009506	-		○	
111,1	116,1	19,8	25	HGW HG517	SB	24375990	-		○	
112	117	19,8	20	HGW HG517	SBK	49000534	-		○	
115	120	9,6	9,7	PTFE B500	SF	24300135	-		○	
	120	14,8	15	HGW HG650	SBK	49006232	-		○	
	120	19,5	20	PTFE B500	SF	24242172	-		○	
	120	24,5	25	HGW HG517	SB	24311951	-		○	
120	125	9,5	9,7	HGW HG650	SBK	49006233	-		○	
	125	9,6	9,7	HGW HG517	SB	24136649 40422150	IP SP		● ●	
	125	9,6	9,7	PTFE B500	SF	24300137	-		○	
	125	14,8	15	HGW HG517	SB	24174685 40422154	IP SP		● ●	
	125	14,8	15	HGW HG650	SBK	49006234	-		○	
	125	14,8	15	HGW HG517	SBK	525470	-		○	
	125	14,8	15	PTFE B500	SF	24300138	-		○	
	125	19,8	20	HGW HG517	SBK	529483	-		○	
	125	24,5	25	HGW HG517	SB	24240122	-		○	
	125	24,5	25	HGW HG650	SBK	49018492	-		○	
	125	34,5	35	HGW HG517	SBK	24380557	-		○	
	125	130	9,5	9,7	HGW HG650	SBK	49006235	-		○
		130	9,6	9,7	HGW HG517	SB	24131068	-		○
130		9,6	9,7	PTFE B500	SF	24300140	IP		●	

d [mm]	D [mm]	H [mm]	L [mm]	Material	Design	Part No.	PU ¹⁾	US	EU
125	130	14,8	15	HGW HG517	SB	24131069	-		○
	130	14,8	15	HGW HG517	SBK	24380163	-		○
	130	14,8	15	HGW HG650	SBK	49006236	-		○
	130	14,8	15	PTFE B500	SF	24300141	IP		●
	130	19,5	20	PTFE B500	SF	24230162	-		○
	130	24,5	25	HGW HG517	SBK	24379074	-		○
	130	24,5	25	HGW HG650	SBK	49006237	-		○
130	135	9,6	9,7	PTFE B500	SF	24300143	-		○
	135	14,8	15	HGW HG517	SB	24172594	-		○
	135	14,8	15	HGW HG650	SBK	49006238	-		○
	135	14,8	15	PTFE B500	SF	24300144	-		○
	135	19,8	20	HGW HG517	SB	24375478	-		○
	135	24,5	25	PTFE B500	SF	24262562	-		○
	138	24,5	25	HGW HG650	SBK	49012430	-		○
135	140	9,6	9,7	PTFE B500	SF	24300146	-		○
	140	14,8	15	HGW HG650	SBK	49006239	-		○
140	145	9,5	9,7	HGW HG650	SBK	49006240	-		○
	145	9,6	9,7	HGW HG517	SB	24131071	-		○
	145	14,8	15	HGW HG517	SB	24131072	IP		●
	145	14,8	15	HGW HG650	SBK	49006241	IP		●
	145	14,8	15	PTFE B500	SF	24300149	-		○
	145	19,5	20	PTFE B500	SF	24328413	-		○
	145	24,5	25	HGW HG517	SB	24143420	-		○
	145	24,5	25	HGW HG650	SBK	49006242	-		○
	145	24,5	25	HGW HG517	SBK	528820	IP		●
	145	24,5	25	PTFE B500	SF	24256885	-		○
	145	39,5	40	HGW HG650	SBK	49009456	-		○
	148	14,8	15	PTFE B500	SF	24327236	-		○
	148	39,5	40	HGW HG517	SBK	528995	-		○
145	150	9,6	9,7	PTFE B500	SF	24248043	-		○
	150	14,8	15	HGW HG517	SBK	24380690	-		○
	150	14,8	15	HGW HG650	SBK	49006243	IP		●
	150	19,8	20	HGW HG517	SB	24342271	-		○
	150	24,5	25	HGW HG517	SB	24349284	-		○
150	155	14,8	15	HGW HG517	SB	24131075	-		○
	155	14,8	15	HGW HG650	SBK	49006244	IP		●
	155	14,8	15	PTFE B500	SF	24300151	-		○
	155	19,5	20	PTFE B500	SF	24203276	-		○
	155	24,5	25	PTFE B500	SF	24168884	-		○
155	160	14,8	15	HGW HG517	SBK	24380691	IP		●
	160	14,8	15	HGW HG650	SBK	49006245	-		○
160	165	9,6	9,7	PTFE B500	SF	24204644	-		○
	165	14,8	15	HGW HG517	SB	24131078	-		○
	165	14,8	15	HGW HG517	SBK	24380782	-		○
	165	14,8	15	HGW HG650	SBK	49006247	-		○
	165	14,8	15	PTFE B500	SF	24204055	-		○
	165	24,5	25	HGW HG517	SBK	24375641 40422504	IP SP		● ●
	165	24,5	25	HGW HG650	SBK	49006248	-		○
	165	24,5	25	PTFE B500	SF	24263903	-		○

d [mm]	D [mm]	H [mm]	L [mm]	Material	Design	Part No.	PU ¹⁾	US	EU
160	168	39,5	40	HGW HG517	SBK	24370365	-		○
165	170	14,8	15	HGW HG517	SB	24183087	-		○
	175	14,8	15	HGW HG517	SB	24190517	-		○
	175	14,8	15	HGW HG517	SBK	24380692	-		○
	175	14,8	15	HGW HG650	SBK	49006250	IP		●
	175	14,8	15	PTFE B500	SF	24300153	IP		●
170	175	24,5	25	HGW HG517	SB	24375858	-		○
	175	24,5	25	HGW HG650	SBK	49006249	IP		●
	175	24,5	25	HGW HG517	SBK	524993	-		○
	178	24,5	25	HGW HG517	SBK	530870	-		○
	178	39,5	40	HGW HG517	SBK	24378034	-		○
175	180	24,5	25	PTFE B500	SF	24264758	-		○
	185	9,5	9,7	HGW HG650	SBK	49006251	-		○
	185	9,6	9,7	PTFE B500	SF	24300154	-		○
	185	14,8	15	HGW HG517	SB	24131081	IP		●
	185	14,8	15	HGW HG517	SBK	24380693	IP		●
	185	14,8	15	HGW HG650	SBK	49006253	-		○
180	185	14,8	15	PTFE B500	SF	24300155	IP		●
	185	24,5	25	HGW HG517	SBK	24379035	-		○
	185	24,5	25	HGW HG650	SBK	49006252	-		○
	185	29,5	30	HGW HG517	SBK	526594	-		○
	185	39,5	40	HGW HG517	SBK	530602	IP		●
	188	24,5	25	HGW HG517	SB	24354370	-		○
	188	39,5	40	HGW HG517	SBK	24378035	-		○
185	190	9,6	9,7	PTFE B500	SF	24291724	-		○
	190	14,8	15	HGW HG650	SBK	49030377	-		○
	195	14,8	15	HGW HG517	SB	24216375	IP		●
	195	14,8	15	HGW HG517	SBK	24380270	IP		●
	195	14,8	15	HGW HG650	SBK	49006254	-		○
190	195	14,8	15	PTFE B500	SF	24300157	-		○
	195	19,8	20	HGW HG650	SBK	49019432	-		○
	195	24,5	25	HGW HG517	SB	24262387	-		○
	198	34,5	35	HGW HG517	SBK	49002019	-		○
195	200	9,6	9,7	PTFE B500	SF	24242182	-		○
	205	14,8	15	HGW HG517	SB	24131084	IP		●
	205	14,8	15	HGW HG517	SBK	24380775	-		○
	205	14,8	15	HGW HG650	SBK	49006259	-		○
	205	14,8	15	PTFE B500	SF	24154721	-		○
	205	24,5	25	HGW HG517	SBK	24379075	-		○
200	205	24,5	25	HGW HG650	SBK	49006258	-		○
	205	24,5	25	PTFE B500	SF	24266925	-		○
	205	34,5	35	HGW HG517	SBK	24378003	-		○
	208	24,5	25	HGW HG517	SB	24227974	-		○
	208	24,5	25	PTFE B500	SF	24299021	-		○
	208	39,5	40	HGW HG517	SBK	24378036	-		○
	215	9,6	9,7	PTFE B500	SF	24300159	-		○
	215	14,8	15	HGW HG517	SB	24226067	IP		●
210	215	14,8	15	HGW HG517	SBK	24380694	IP		●
	215	14,8	15	HGW HG650	SBK	49006260	-		○
	215	14,8	15	PTFE B500	SF	24300160	IP		●

d [mm]	D [mm]	H [mm]	L [mm]	Material	Design	Part No.	PU ¹⁾	US	EU
210	215	19,5	20	PTFE B500	SF	24239042	-		○
	218	24,5	25	HGW HG517	SB	24263732	-		○
	218	24,5	25	HGW HG517	SBK	530265	-		○
220	225	9,6	9,7	PTFE B500	SF	24300161	-		○
	225	14,8	15	HGW HG517	SB	24209167	-		○
	225	14,8	15	HGW HG517	SBK	24372435	-		○
	225	14,8	15	HGW HG650	SBK	49006281	-		○
	225	14,8	15	PTFE B500	SF	24300162	-		○
	225	19,5	20	PTFE B500	SF	24157304	-		○
	225	24,5	25	HGW HG517	SBK	24379036	-		○
	225	24,5	25	HGW HG650	SBK	49006282	-		○
230	228	39,5	40	HGW HG517	SBK	24378037	-		○
	235	14,8	15	HGW HG517	SB	24226069	IP		●
	235	14,8	15	HGW HG517	SBK	24380269	-		○
	235	14,8	15	HGW HG650	SBK	49006283	-		○
	235	14,8	15	PTFE B500	SF	24154716	-		○
	235	19,5	20	PTFE B500	SF	24342108	-		○
	235	19,8	20	HGW HG517	SB	24342273	-		○
240	235	24,5	25	HGW HG517	SBK	24379253	-		○
	245	9,6	9,7	PTFE B500	SF	24258216	-		○
	245	14,8	15	HGW HG517	SB	24197575	-		○
	245	14,8	15	HGW HG517	SBK	24380255	-		○
	245	14,8	15	HGW HG650	SBK	49006285	-		○
	245	14,8	15	PTFE B500	SF	24223045	-		○
	245	24,5	25	HGW HG517	SB	24354796	-		○
	245	24,5	25	HGW HG517	SBK	530267	-		○
	245	24,5	25	PTFE B500	SF	24314554	-		○
	248	24,5	25	HGW HG517	SB	24262692	-		○
245	248	39,5	40	HGW HG517	SBK	24378038	-		○
	250	24,5	25	PTFE B500	SF	24311377	-		○
250	255	14,8	15	HGW HG517	SB	24226070	-		○
	255	14,8	15	HGW HG517	SBK	24380273	IP		●
	255	14,8	15	HGW HG650	SBK	49006286	-		○
	255	14,8	15	PTFE B500	SF	24300163	-		○
	255	24,5	25	HGW HG517	SBK	24379037	-		○
	255	24,5	25	HGW HG650	SBK	49006287	-		○
	256	24,5	25	HGW HG517	SBK	49002878	-		○
255	260	24,5	25	HGW HG517	SBK	49002907	-		○
260	265	14,8	15	HGW HG517	SB	24226071	IP		●
	265	14,8	15	PTFE B500	SF	24300164	-		○
	268	24,5	25	HGW HG517	SBK	49003297	-		○
	268	39,5	40	HGW HG517	SBK	24378039	-		○
270	275	24,5	25	HGW HG517	SBK	24380271	IP		●
	275	24,5	25	HGW HG650	SBK	49006288	-		○
	275	24,5	25	PTFE B500	SF	24262561	-		○
280	285	14,8	15	HGW HG517	SB	24226073	-		○
	285	14,8	15	HGW HG517	SBK	24380777	-		○
	285	14,8	15	HGW HG650	SBK	49006290	-		○
	285	14,8	15	PTFE B500	SF	24300166	IP		●
	285	24,5	25	HGW HG517	SB	24351791	-		○

d [mm]	D [mm]	H [mm]	L [mm]	Material	Design	Part No.	PU ¹⁾	US	EU
280	285	24,5	25	HGW HG517	SBK	24379038	IP		●
	285	24,5	25	HGW HG650	SBK	49006289	–		○
	288	14,8	15	HGW HG517	SBK	24379158	–		○
	288	24,5	25	HGW HG517	SB	24353315	–		○
	288	34,5	35	HGW HG517	SBK	24379347	–		○
	288	39,5	40	HGW HG517	SBK	24378040	–		○
290	295	14,8	15	PTFE B500	SF	24300167	IP		●
	298	24,5	25	HGW HG517	SBK	24379491	–		○
	298	24,5	25	HGW HG650	SBK	49006291	–		○
292	297	24,5	25	HGW HG517	SBK	528857	–		○
300	305	14,8	15	HGW HG517	SB	24191327	IP		●
	305	14,8	15	PTFE B500	SF	24300168	IP		●
	305	24,5	25	HGW HG600	SB	24334866	–		○
	305	24,5	25	PTFE B500	SF	24348072	–		○
	308	24,5	25	HGW HG600	SB	24256760	–		○
	308	24,5	25	HGW HG600	SBK	24380482	IP		●
	308	39,5	40	HGW HG600	SBK	24379155	–		○
310	315	14,8	15	HGW HG600	SB	24226075	–		○
	315	14,8	15	HGW HG650	SBK	49078777	–		○
	315	14,8	15	PTFE B500	SF	24300169	–		○
	315	24,5	25	HGW HG600	SB	24343892	–		○
	315	24,5	25	HGW HG650	SBK	49078778	–		○
	318	24,5	25	HGW HG600	SB	24294293	–		○
316,2	321,2	24,5	25	HGW HG600	SB	49044808	–		○
320	325	14,8	15	HGW HG600	SB	24226076	IP		●
	325	14,8	15	HGW HG600	SBK	24380778	–		○
	325	14,8	15	HGW HG650	SBK	49078779	–		○
	325	24,5	25	HGW HG600	SB	24226077	–		○
	325	24,5	25	HGW HG600	SBK	24380272	IP		●
	325	24,5	25	HGW HG650	SBK	49078775	–		○
	325	29,5	30	HGW HG650	SBK	49078780	–		○
	328	24,5	25	HGW HG600	SB	24308092	–		○
	328	24,5	25	HGW HG600	SBK	24379076	–		○
	328	24,5	25	HGW HG650	SBK	49078781	–		○
	328	29,5	30	HGW HG650	SBK	49078822	–		○
	328	29,5	30	HGW HG600	SBK	528486	–		○
	328	39,5	40	HGW HG650	SBK	49078823	–		○
	328	39,5	40	HGW HG600	SBK	532132	–		○
325	330	24,5	25	PTFE B500	SF	24293821	–		○
330	335	14,8	15	HGW HG600	SB	24226078	IP		●
	335	14,8	15	PTFE B500	SF	24300172	–		○
	335	24,5	25	HGW HG600	SB	24187413	–		○
	335	24,5	25	HGW HG650	SBK	49078824	–		○
	335	24,5	25	PTFE B500	SF	24300173	–		○
	338	24,5	25	HGW HG600	SBK	24379040	–		○
	338	24,5	25	HGW HG650	SBK	49078825	–		○
340	345	14,8	15	HGW HG600	SB	24226079	–		○
	345	14,8	15	HGW HG650	SBK	49078826	–		○
	345	14,8	15	PTFE B500	SF	24300174	–		○
	345	24,5	25	HGW HG600	SB	24226080	–		○

d [mm]	D [mm]	H [mm]	L [mm]	Material	Design	Part No.	PU ¹⁾	US	EU
340	345	24,5	25	PTFE B500	SF	24162997	-		○
	348	24,5	25	HGW HG650	SBK	49078827	-		○
	348	39,5	40	HGW HG650	SBK	49063892	-		○
343	348	14,8	15	PTFE B500	SF	24301095	-		○
350	355	14,8	15	HGW HG600	SB	24226081	-		○
	355	14,8	15	HGW HG600	SBK	24380779	-		○
	355	14,8	15	PTFE B500	SF	24300175	-		○
	355	24,5	25	HGW HG600	SB	24226082	-		○
	355	24,5	25	HGW HG650	SBK	49078828	-		○
	355	24,5	25	PTFE B500	SF	24300176	-		○
	358	24,5	25	HGW HG600	SB	24337997	-		○
	358	24,5	25	HGW HG600	SBK	24379041	-		○
	358	24,5	25	HGW HG650	SBK	49078829	-		○
	358	24,5	25	PTFE B500	SF	24337998	-		○
	358	39,5	40	HGW HG650	SBK	49078830	-		○
360	365	14,8	15	HGW HG600	SB	24226083	IP		●
	365	14,8	15	PTFE B500	SF	24300177	-		○
	365	24,5	25	HGW HG600	SB	24226084	-		○
	365	24,5	25	HGW HG600	SBK	24380275	IP		●
	365	24,5	25	HGW HG650	SBK	49078831	-		○
	365	39,5	40	HGW HG650	SBK	49078832	-		○
	368	24,5	25	HGW HG600	SB	24342012	-		○
	368	24,5	25	HGW HG600	SBK	24375318	-		○
	368	24,5	25	HGW HG650	SBK	49078833	-		○
	368	24,5	25	PTFE B500	SF	24342011	-		○
	368	39,5	40	HGW HG650	SBK	49059762	-		○
368	39,5	40	HGW HG600	SBK	531873	-		○	
370	375	14,8	15	HGW HG650	SBK	49078834	-		○
	375	24,5	25	HGW HG600	SB	24327519	-		○
	378	24,5	25	HGW HG600	SBK	24379042	-		○
	378	24,5	25	HGW HG650	SBK	49078835	-		○
	378	34,5	35	HGW HG600	SBK	49000975	-		○
	378	34,5	35	HGW HG650	SBK	49078836	-		○
380	385	14,8	15	HGW HG600	SB	24353459	-		○
	385	24,5	25	HGW HG600	SB	24250195	-		○
	385	24,5	25	HGW HG650	SBK	49078837	-		○
	385	24,5	25	HGW HG600	SBK	531516	-		○
	388	24,5	25	HGW HG600	SBK	24379138	-		○
	388	24,5	25	HGW HG650	SBK	49078838	-		○
	388	39,5	40	HGW HG600	SBK	24379245	-		○
	388	39,5	40	HGW HG650	SBK	49078839	-		○
390	395	14,8	15	HGW HG600	SB	24375951	-		○
	395	14,8	15	PTFE B500	SF	24350238	-		○
	395	24,5	25	HGW HG600	SB	24187414	-		○
	395	24,5	25	HGW HG600	SBK	24380276	-		○
	395	24,5	25	HGW HG650	SBK	49078840	-		○
	395	24,5	25	PTFE B500	SF	24336658	-		○
	398	24,5	25	HGW HG600	SB	24307327	-		○
	398	24,5	25	PTFE B500	SF	24355839	-		○
400	405	14,8	15	HGW HG600	SB	24345757	-		○

d [mm]	D [mm]	H [mm]	L [mm]	Material	Design	Part No.	PU ¹⁾	US	EU
	405	14,8	15	HGW HG600	SBK	24380781	-		○
	405	14,8	15	HGW HG650	SBK	49078841	-		○
	405	14,8	15	PTFE B500	SF	24274959	-		○
	405	24,5	25	HGW HG600	SB	24333824	-		○
	405	24,5	25	HGW HG600	SBK	49012525	IP		●
	405	24,5	25	HGW HG650	SBK	49078843	-		○
400	405	29,5	30	HGW HG650	SBK	49078844	-		○
	408	24,5	25	HGW HG600	SB	24259182	-		○
	408	24,5	25	HGW HG600	SBK	24375319	IP		●
	408	24,5	25	HGW HG650	SBK	49078845	-		○
	408	24,5	25	PTFE B500	SF	24269425	-		○
	408	39,5	40	HGW HG650	SBK	49063893	-		○
	408	39,5	40	HGW HG600	SBK	526027	-		○
406,4	414,4	24,5	25	HGW HG600	SB	24361390	-		○
	415	14,8	15	HGW HG600	SB	24288046	-		○
	415	14,8	15	HGW HG650	SBK	49078846	-		○
	415	14,8	15	PTFE B500	SF	49045103	-		○
410	415	24,5	25	HGW HG600	SB	24294216	IP		●
	415	24,5	25	HGW HG650	SBK	49078847	-		○
	415	24,5	25	PTFE B500	SF	24296901	-		○
	418	24,5	25	HGW HG650	SBK	49078848	-		○
	425	14,8	15	HGW HG600	SB	24356361	-		○
	425	19,5	20	PTFE B500	SF	24230161	-		○
	425	24,5	25	HGW HG600	SB	24329919	-		○
	425	24,5	25	HGW HG650	SBK	49078849	-		○
420	425	24,5	25	HGW HG600	SBK	527921	IP		●
	425	24,5	25	PTFE B500	SF	24233817	-		○
	428	24,5	25	HGW HG600	SB	24346468	-		○
	428	24,5	25	PTFE B500	SF	24269684	-		○
	428	39,5	40	HGW HG600	SBK	24379322	IP		●
	428	39,5	40	HGW HG650	SBK	49078851	-		○
425	430	24,5	25	PTFE B500	SF	24261535	IP		●
	430	19,5	20	PTFE B500	SF	24203171	-		○
	435	24,5	25	PTFE B500	SF	24348071	-		○
431,8	439,8	24,5	25	PTFE B500	SF	24362369	-		○
435	440	24,5	25	PTFE B500	SF	24162988	-		○
	445	24,5	25	HGW HG650	SBK	49078852	-		○
	445	24,5	25	PTFE B500	SF	24344261	-		○
	448	19,8	20	HGW HG600	SBK	24378391	-		○
440	448	24,5	25	HGW HG600	SB	24363242	-		○
	448	24,5	25	HGW HG600	SBK	24375320	-		○
	448	24,5	25	HGW HG650	SBK	49078853	-		○
	448	39,5	40	HGW HG650	SBK	49078854	-		○
	448	39,5	40	HGW HG600	SBK	526028	-		○
445	453	39,5	40	HGW HG600	SBK	49004008	-		○
	455	14,8	15	HGW HG600	SB	24265877	-		○
	455	14,8	15	PTFE B500	SF	24265878	-		○
450	455	24,5	25	HGW HG600	SB	24339926	-		○
	455	24,5	25	PTFE B500	SF	24257338	-		○
	458	24,5	25	HGW HG600	SB	24294987	-		○









d [mm]	D [mm]	H [mm]	L [mm]	Material	Design	Part No.	PU ¹⁾	US	EU	
450	458	24,5	25	HGW HG600	SBK	24380453	-		○	
	458	24,5	25	HGW HG650	SBK	49078855	-		○	
	458	24,5	25	PTFE B500	SF	24294991	-		○	
	458	39,5	40	HGW HG650	SBK	49078856	-		○	
457,2	465,2	24,5	25	HGW HG600	SB	24367537	-		○	
460	465	14,8	15	HGW HG600	SB	24356363	-		○	
	465	24,5	25	HGW HG600	SB	24339221	-		○	
	465	24,5	25	HGW HG600	SBK	49001818	-		○	
	465	24,5	25	HGW HG650	SBK	49078857	-		○	
	465	24,5	25	PTFE B500	SF	24308715	-		○	
	468	24,5	25	HGW HG600	SB	24269407	-		○	
	468	24,5	25	HGW HG600	SBK	24375321	-		○	
	468	24,5	25	HGW HG650	SBK	49078858	-		○	
	468	24,5	25	PTFE B500	SF	24269409	-		○	
	463,6	471,6	24,5	25	HGW HG600	SB	24361809	-		○
470	471,6	24,5	25	PTFE B500	SF	24361808	-		○	
	475	14,8	15	HGW HG600	SB	24327589	-		○	
	475	14,8	15	HGW HG650	SBK	49078859	-		○	
	475	24,5	25	HGW HG600	SB	24359238	IP		●	
	475	24,5	25	PTFE B500	SF	24347036	IP		●	
	478	24,5	25	PTFE B500	SF	24274936	-		○	
	478	39,5	40	HGW HG650	SBK	49078860	-		○	
	475	480	24,5	25	PTFE B500	SF	24261562	-		○
	483	24,5	25	HGW HG600	SB	24334724	-		○	
	480	485	24,5	25	HGW HG600	SB	24339373	-		○
485		24,5	25	PTFE B500	SF	24261536	-		○	
488		24,5	25	HGW HG600	SB	24291803	-		○	
488		24,5	25	PTFE B500	SF	24337938	-		○	
488		39,5	40	HGW HG650	SBK	49067023	-		○	
490	495	14,8	15	PTFE B500	SF	24366903	-		○	
	495	39,5	40	HGW HG650	SBK	49078861	-		○	
	498	24,5	25	HGW HG600	SB	24290172	-		○	
500	505	14,8	15	HGW HG600	SB	24356362	-		○	
	505	14,8	15	PTFE B500	SF	24264832	-		○	
	505	24,5	25	HGW HG600	SB	24269675	-		○	
	505	24,5	25	PTFE B500	SF	24263467	-		○	
	508	19,5	20	PTFE B500	SF	24360925	-		○	
	508	19,8	20	HGW HG600	SBK	24378392	-		○	
	508	19,8	20	HGW HG650	SBK	49078862	-		○	
	508	24,5	25	HGW HG600	SB	24269421	-		○	
	508	24,5	25	HGW HG600	SBK	24375322	IP		●	
	508	24,5	25	HGW HG650	SBK	49078863	-		○	
	508	24,5	25	PTFE B500	SF	24269420	-		○	
	508	34,5	35	HGW HG650	SBK	49078864	-		○	
	508	39,5	40	HGW HG600	SBK	24379324	-		○	
	508	39,5	40	HGW HG650	SBK	49062931	-		○	
	508	516	24,5	25	HGW HG600	SB	24346656	-		○
510	515	24,5	25	HGW HG650	SBK	49078865	-		○	
	515	24,5	25	PTFE B500	SF	24269186	-		○	
	518	24,5	25	HGW HG600	SB	24299556	-		○	

d [mm]	D [mm]	H [mm]	L [mm]	Material	Design	Part No.	PU ¹⁾	US	EU
510	518	24,5	25	HGW HG650	SBK	49078866	-		○
	518	24,5	25	HGW HG600	SBK	530266	-		○
520	525	19,5	20	PTFE B500	SF	24242786	-		○
	525	24,5	25	HGW HG600	SB	24345682	-		○
	525	29,5	30	HGW HG650	SBK	49078867	-		○
	528	24,5	25	HGW HG600	SB	24329460	-		○
	528	24,5	25	HGW HG650	SBK	49078868	-		○
	528	39,5	40	HGW HG650	SBK	49078869	-		○
	530	535	14,8	15	HGW HG600	SB	24356360	-	
530	538	24,5	25	HGW HG600	SB	24363243	-		○
	538	24,5	25	HGW HG600	SBK	24375323	IP		●
	538	24,5	25	HGW HG650	SBK	49078871	-		○
	538	39,5	40	HGW HG600	SBK	49004922	-		○
	538	39,5	40	HGW HG650	SBK	49078962	-		○
535	540	9,6	9,7	HGW HG600	SB	24351386	-		○
540	545	24,5	25	HGW HG650	SBK	49078963	-		○
	545	24,5	25	PTFE B500	SF	24358194	-		○
	548	24,5	25	HGW HG600	SB	24274965	-		○
	548	24,5	25	PTFE B500	SF	24332687	-		○
	548	39,5	40	HGW HG600	SBK	49018518	-		○
	548	39,5	40	HGW HG650	SBK	49078964	-		○
550	555	24,5	25	HGW HG600	SB	24362838	-		○
	555	24,5	25	PTFE B500	SF	24344262	-		○
	558	24,5	25	HGW HG600	SBK	49016779	-		○
	558	24,5	25	HGW HG650	SBK	49078965	-		○
	558	39,5	40	HGW HG600	SBK	49005155	-		○
	558	39,5	40	HGW HG650	SBK	49078966	-		○
558,8	566,8	24,5	25	HGW HG600	SB	24361615	-		○
560	568	24,5	25	HGW HG600	SB	24275169	-		○
	568	24,5	25	HGW HG600	SBK	24375324	IP		●
	568	24,5	25	HGW HG650	SBK	49078967	-		○
	568	24,5	25	PTFE B500	SF	24274998	-		○
570	575	24,5	25	HGW HG600	SB	24250196	-		○
	575	24,5	25	PTFE B500	SF	24263227	-		○
	578	24,5	25	HGW HG600	SB	24315103	-		○
	578	24,5	25	HGW HG650	SBK	49078968	-		○
	578	39,5	40	HGW HG650	SBK	49078969	-		○
580	588	24,5	25	HGW HG600	SB	24307424	-		○
	588	24,5	25	PTFE B500	SF	24307426	-		○
	588	39,5	40	HGW HG650	SBK	49078970	-		○
590	595	24,5	25	HGW HG600	SB	24316066	-		○
	595	24,5	25	PTFE B500	SF	24290939	-		○
	598	24,5	25	HGW HG600	SB	24288148	-		○
596,9	604,9	29,5	30	PTFE B500	SF	24236371	-		○
600	605	14,8	15	PTFE B500	SF	24316132	-		○
	605	19,5	20	PTFE B500	SF	24300403	-		○
	605	24,5	25	HGW HG600	SB	24337098	-		○
	605	24,5	25	HGW HG650	SBK	49078971	-		○
	605	24,5	25	HGW HG600	SBK	528326	IP		●
	608	24,5	25	HGW HG600	SB	24340044	-		○

d [mm]	D [mm]	H [mm]	L [mm]	Material	Design	Part No.	PU ¹⁾	US	EU
600	608	24,5	25	HGW HG600	SBK	24375325	-		○
	608	24,5	25	HGW HG650	SBK	49078982	-		○
	608	24,5	25	PTFE B500	SF	24354936	-		○
	608	39,5	40	HGW HG600	SBK	49003964	-		○
	608	39,5	40	HGW HG650	SBK	49078983	-		○
620	625	14,8	15	HGW HG650	SBK	49078984	-		○
	625	19,5	20	PTFE B500	SF	24291416	-		○
	625	24,5	25	PTFE B500	SF	24354129	-		○
	628	24,5	25	HGW HG650	SBK	49078985	-		○
630	635	19,5	20	PTFE B500	SF	24361332	-		○
	635	24,5	25	PTFE B500	SF	24263904	-		○
	638	24,5	15	HGW HG600	SBK	524927	-		○
	638	24,5	25	HGW HG600	SB	24308091	-		○
	638	24,5	25	HGW HG650	SBK	49078986	-		○
640	648	24,5	25	HGW HG600	SB	24298435	-		○
	648	24,5	25	PTFE B500	SF	24298429	-		○
650	655	14,8	15	HGW HG600	SB	24302588	-		○
	655	24,5	25	HGW HG600	SB	24302589	-		○
	658	24,5	25	HGW HG600	SB	24293966	-		○
	658	24,5	25	PTFE B500	SF	24293967	-		○
	658	34,5	35	HGW HG600	SBK	24378494	-		○
660	665	24,5	25	HGW HG600	SB	24336388	-		○
670	675	24,5	25	HGW HG600	SB	24353636	-		○
	675	24,5	25	PTFE B500	SF	24162996	-		○
	678	24,5	25	HGW HG600	SB	24300401	-		○
	678	24,5	25	PTFE B500	SF	24361116	-		○
675	680	24,5	25	PTFE B500	SF	24261537	-		○
680	688	24,5	25	HGW HG600	SB	24269484	-		○
700	705	14,8	15	HGW HG600	SB	24257373	-		○
	705	14,8	15	PTFE B500	SF	24234909	-		○
	705	24,5	25	PTFE B500	SF	24223046	-		○
	708	29,5	30	PTFE B500	SF	24262945	-		○
	708	39,5	40	HGW HG600	SBK	529519	-		○
710	715	24,5	25	HGW HG600	SB	24359709	-		○
	718	14,8	15	PTFE B500	SF	24216172	-		○
	718	24,5	25	HGW HG600	SBK	49017422	-		○
	718	39,5	40	HGW HG600	SBK	49012632	-		○
720	728	24,5	25	HGW HG600	SB	24295834	-		○
	728	24,5	25	PTFE B500	SF	24359660	-		○
730	735	24,5	25	HGW HG600	SB	24362406	-		○
	738	24,5	25	PTFE B500	SF	24263632	-		○
	738	39,5	40	HGW HG600	SBK	49015646	-		○
735	740	24,5	25	PTFE B500	SF	24163718	-		○
740	748	19,5	20	PTFE B500	SF	24344397	-		○
	748	24,5	25	HGW HG600	SB	24243177	-		○
	748	24,5	25	HGW HG600	SBK	49000239	-		○
	748	24,5	25	PTFE B500	SF	24243175	-		○
749,5	757,5	24,5	25	HGW HG600	SB	24367124	-		○
750	755	24,5	25	PTFE B500	SF	24227972	-		○
	758	24,5	25	HGW HG600	SB	24306400	-		○

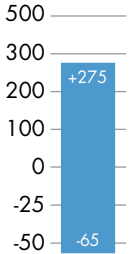
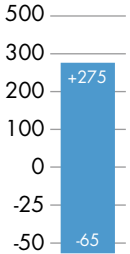
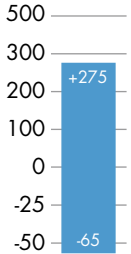
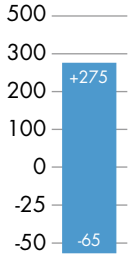
d [mm]	D [mm]	H [mm]	L [mm]	Material	Design	Part No.	PU ¹⁾	US	EU
760	768	24,5	25	HGW HG600	SBK	24380545	-		○
787,4	795,4	24,5	25	HGW HG600	SB	24331518	-		○
	795,4	24,5	25	PTFE B500	SF	24331521	-		○
790	798	19,8	20	HGW HG600	SBK	531677	-		○
	798	24,5	25	HGW HG600	SB	24351818	-		○
	798	24,5	25	PTFE B500	SF	24351827	-		○
	798	34,5	35	HGW HG600	SBK	49003032	-		○
	798	39,5	40	HGW HG600	SBK	49015647	-		○
800	805	24,5	25	PTFE B500	SF	24162994	-		○
	808	19,8	20	HGW HG650	SBK	49078987	-		○
	808	24,5	25	HGW HG600	SB	24295217	-		○
	808	24,5	25	HGW HG650	SBK	49075919	-		○
	808	24,5	25	HGW HG600	SBK	526190	-		○
	808	24,5	25	PTFE B500	SF	24295216	-		○
	808	39,5	40	HGW HG650	SBK	49061155	-		○
820	828	19,5	20	PTFE B500	SF	24238051	-		○
	828	24,5	25	HGW HG600	SB	24335809	-		○
	828	24,5	25	HGW HG650	SBK	49078988	-		○
	828	24,5	25	HGW HG600	SBK	528715	IP		●
	828	39,5	40	HGW HG650	SBK	49078989	-		○
	828	39,5	40	HGW HG600	SBK	528716	IP		●
830	838	24,5	25	HGW HG600	SB	24339267	-		○
	838	24,5	25	PTFE B500	SF	24344381	-		○
850	858	24,5	25	HGW HG600	SB	24269891	-		○
	858	24,5	25	PTFE B500	SF	24314615	-		○
	858	29,5	30	HGW HG650	SBK	49078990	-		○
	858	39,5	40	HGW HG650	SBK	49062409	-		○
860	868	24,5	25	HGW HG600	SB	24294618	-		○
880	888	24,5	25	HGW HG600	SB	24336302	-		○
890	898	14,8	15	HGW HG600	SB	24297567	-		○
	898	14,8	15	PTFE B500	SF	24263607	-		○
	898	19,8	20	HGW HG600	SBK	49003043	-		○
	898	19,8	20	HGW HG650	SBK	49078991	-		○
	898	24,5	25	HGW HG600	SB	24338494	-		○
	898	24,5	25	PTFE B500	SF	24263885	-		○
	898	34,5	35	HGW HG600	SBK	49020525	-		○
	898	34,5	35	HGW HG650	SBK	49079002	-		○
	898	34,5	35	HGW HG600	SBK	49079003	-		○
900	905	24,5	25	HGW HG650	SBK	49079003	-		○
	905	39,5	40	HGW HG650	SBK	49079004	-		○
	908	24,5	25	HGW HG600	SB	24257240	-		○
	908	24,5	25	HGW HG650	SBK	49079005	-		○
	908	24,5	25	PTFE B500	SF	24257241	-		○
910	908	39,5	40	HGW HG650	SBK	49054648	-		○
	918	39,5	40	HGW HG650	SBK	49079006	-		○
920	928	39,5	40	HGW HG650	SBK	49079007	-		○
950	958	19,8	20	HGW HG650	SBK	49079008	-		○
	958	24,5	25	HGW HG600	SB	24294142	-		○
	958	24,5	25	PTFE B500	SF	24233242	-		○
	958	29,5	30	HGW HG650	SBK	49079009	-		○
	958	39,5	40	HGW HG650	SBK	49077824	-		○

d [mm]	D [mm]	H [mm]	L [mm]	Material	Design	Part No.	PU ¹⁾	US	EU
970	978	24,5	25	HGW HG600	SB	24359657	IP		●
	978	24,5	25	HGW HG600	SBK	24376186	-		○
	978	39,5	40	HGW HG650	SBK	49063920	-		○
975	983	24,5	25	HGW HG600	SB	24293718	-		○
	983	24,5	25	PTFE B500	SF	24361413	-		○
990	996,3	29,5	30	HGW HG600	SBK	49004975	-		○
	998	39,5	40	HGW HG650	SBK	49074251	-		○
1000	1005	24,5	25	HGW HG600	SB	24352886	-		○
	1008	24,5	25	HGW HG600	SBK	49017423	-		○
	1008	24,5	25	HGW HG650	SBK	49079010	-		○
1050	1058	24,5	25	HGW HG600	SB	24296553	-		○
	1058	24,5	25	PTFE B500	SF	24296554	-		○
1100	1108	24,5	25	HGW HG600	SBK	49017424	-		○
	1108	34,5	35	HGW HG600	SBK	533289	-		○
	1108	39,5	40	HGW HG650	SBK	49066611	-		○
1130	1138	24,5	25	HGW HG600	SBK	530019	IP		●
1145	1153	39,5	40	HGW HG600	SBK	49002141	-		○
1150	1158	24,5	25	HGW HG600	SB	24357301	-		○
	1158	24,5	25	PTFE B500	SF	24357284	-		○
	1158	39,5	40	HGW HG650	SBK	49079233	-		○
1200	1208	39,5	40	HGW HG650	SBK	49066357	-		○
1250	1258	39,5	40	HGW HG650	SBK	49079097	-		○
1295,40	1303,40	24,5	25	HGW HG600	SB	24363063	-		○
1300	1308	39,5	40	HGW HG650	SBK	49079098	-		○
1340	1348	39,5	40	HGW HG600	SBK	531144	-		○
1350	1358	39,5	40	HGW HG650	SBK	49079099	-		○
	1358	39,5	40	HGW HG600	SBK	531904	-		○
1400	1408	39,5	40	HGW HG650	SBK	49079100	-		○
1450	1458	39,5	40	HGW HG650	SBK	49079101	-		○
1500	1508	39,5	40	HGW HG650	SBK	49044252	-		○
1625,60	1633,60	39,5	40	HGW HG600	SBK	528780	-		○
1626	1634	39,5	40	HGW HG600	SBK	527116	-		○
1650	1658	24,5	25	HGW HG600	SB	24335492	-		○

Type	8000	8001	2000	2001	
Standard	AS	AS	AS	AS	
Shape					
Compound	Reinforced Nylon VN9800	Reinforced Nylon VN9800	Thermoplastic resin VN9400	Thermoplastic resin VN9400	
					
Applications					

Bitte beachten Sie unsere allgemeinen Konstruktionshinweise in → Technisches Handbuch
 Daha detaylı montaj bilgisi için → Bkz. Technical Manual
 W celu zaznajomienia się z ogólnymi uwagami proszę skorzystać z Instrukcji
 Общие технические рекомендации см. → Техническое руководство

KOLBENFÜHRUNGSRINGE | PISTON YATAKLAMA ELEMANLARI PROWADNICA TŁOKA | ПОРШНЕВЫЕ НАПРАВЛЯЮЩИЕ КОЛЬЦА

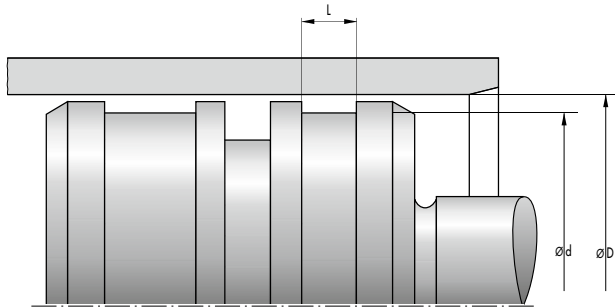
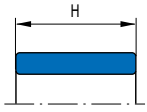

Wenn Sie Ihre Dichtung nicht finden können – Ihre Lösung auf Seite 12
 Aradığınız ürünü bulamadığınız takdirde – çözümünüz sayfa 12
 Jeżeli nie możecie Państwo znaleźć uszczelki – rozwiązanie znajduje się na stronie 12
 Вы не можете подобрать необходимое уплотнение? – Решение на странице 12

1) IP = Industriepackung | Endüstriyel ambalaj | Opakowania przemysłowe | Производственная тара
 SP = Einzelpackung | Tek bir Paket | Pojedyncze opakowanie | Single Pack

● Auf Lager | Stoklarda mevcuttur | Dostępne w magazynie | Имеется в наличии на складе
 ○ Auf Anfrage | Talep üzerine | Na zapytanie | По запросу

D [inch]	d [inch]	H [inch]	L [inch]	Material	Design	Part No.	PU ¹⁾	US	EU
1	0,75	0,25	0,35	VN 9800	8000	568000-016-0250	–	●	
	0,75	0,312	0,412	VN 9800	8000	568000-016-0312	–	○	
	0,75	0,375	0,475	VN 9800	8000	568000-016-0375	–	○	
	0,75	0,5	0,6	VN 9800	8000	568000-016-0500	–	○	
1,125	0,875	0,25	0,35	VN 9400	2000	562000-018-0250	–	○	
	0,875	0,25	0,35	VN 9800	8000	568000-018-0250	–	●	
	0,875	0,312	0,412	VN 9400	2000	562000-018-0312	–	○	
	0,875	0,375	0,475	VN 9400	2000	562000-018-0375	–	○	
	0,875	0,375	0,475	VN 9800	8000	568000-018-0375	–	○	
	0,875	0,5	0,6	VN 9400	2000	562000-018-0500	–	○	
	0,875	0,5	0,6	VN 9800	8000	568000-018-0500	–	○	
	1,001	0,375	0,475	VN 9800	8000	568062-018-0375	–	○	
	1,001	0,5	0,6	VN 9800	8000	568062-018-0500	–	○	
1,001	0,625	0,725	VN 9800	8000	568062-018-0625	–	○		
1,25	1	0,187	0,287	VN 9800	8000	568000-020-0187	–	○	
	1	0,25	0,35	VN 9400	2000	562000-020-0250	–	○	
	1	0,25	0,35	VN 9800	8000	568000-020-0250	–	●	
	1	0,375	0,475	VN 9400	2000	562000-020-0375	–	○	
	1	0,375	0,475	VN 9800	8000	568000-020-0375	–	●	
	1	0,75	0,85	VN 9800	8000	568000-020-0750	–	○	
	1	1	1,1	VN 9400	2000	562000-020-1000	–	○	
	1,126	0,375	0,475	VN 9800	8000	568062-020-0375	–	○	
	1,126	0,5	0,6	VN 9800	8000	568062-020-0500	–	○	
1,375	1,125	0,375	0,475	VN 9400	2000	562000-022-0375	–	○	
	1,125	0,375	0,475	VN 9800	8000	568000-022-0375	–	○	
	1,125	0,5	0,6	VN 9400	2000	562000-022-0500	–	○	
	1,125	0,5	0,6	VN 9800	8000	568000-022-0500	–	○	
	1,251	0,5	0,6	VN 9800	8000	568062-022-0500	–	○	
1,5	1,25	0,187	0,287	VN 9400	2000	562000-024-0187	–	○	
	1,25	0,187	0,287	VN 9800	8000	568000-024-0187	–	●	

D [inch]	d [inch]	H [inch]	L [inch]	Material	Design	Part No.	PU ¹⁾	US	EU
1,5	1,25	0,25	0,35	VN 9400	2000	562000-024-0250	-	○	
	1,25	0,25	0,35	VN 9800	8000	568000-024-0250	-	○	
	1,25	0,375	0,475	VN 9400	2000	562000-024-0375	-	○	
	1,25	0,375	0,475	VN 9800	8000	568000-024-0375	-	○	
	1,25	0,5	0,6	VN 9400	2000	562000-024-0500	-	○	
	1,25	0,5	0,6	VN 9800	8000	568000-024-0500	-	○	
	1,25	0,75	0,85	VN 9400	2000	562000-024-0750	-	○	
	1,376	0,5	0,6	VN 9800	8000	568062-024-0500	-	○	
1,625	1,375	0,25	0,35	VN 9800	8000	568000-026-0250	-	●	
	1,375	0,375	0,475	VN 9400	2000	562000-026-0375	-	○	
	1,375	0,375	0,475	VN 9800	8000	568000-026-0375	-	●	
	1,375	0,5	0,6	VN 9800	8000	568000-026-0500	-	○	
	1,375	0,625	0,725	VN 9800	8000	568000-026-0625	-	○	
	1,501	0,375	0,475	VN 9800	8000	568062-026-0375	-	○	
	1,501	0,5	0,6	VN 9800	8000	568062-026-0500	-	○	
1,75	1,5	0,187	0,287	VN 9400	2000	562000-028-0187	-	○	
	1,5	0,187	0,287	VN 9800	8000	568000-028-0187	-	○	
	1,5	0,25	0,35	VN 9400	2000	562000-028-0250	-	○	
	1,5	0,25	0,35	VN 9800	8000	568000-028-0250	-	○	
	1,5	0,312	0,412	VN 9800	8000	568000-028-0312	-	○	
	1,5	0,375	0,475	VN 9400	2000	562000-028-0375	-	○	
	1,5	0,375	0,475	VN 9800	8000	568000-028-0375	-	○	
	1,5	0,5	0,6	VN 9400	2000	562000-028-0500	-	○	
	1,5	0,5	0,6	VN 9800	8000	568000-028-0500	-	○	
	1,5	0,625	0,725	VN 9800	8000	568000-028-0625	-	○	
	1,5	1	1,1	VN 9800	8000	568000-028-1000	-	○	
	1,626	0,375	0,475	VN 9800	8000	568062-028-0375	-	○	
1,626	0,5	0,6	VN 9800	8000	568062-028-0500	-	○		
1,875	1,625	0,25	0,35	VN 9400	2000	562000-030-0250	-	○	
	1,625	0,5	0,6	VN 9800	8000	568000-030-0500	-	○	
2	1,75	0,187	0,287	VN 9800	8000	568000-032-0187	-	○	
	1,75	0,25	0,35	VN 9400	2000	562000-032-0250	-	○	
	1,75	0,25	0,35	VN 9800	8000	568000-032-0250	-	●	
	1,75	0,312	0,412	VN 9400	2000	562000-032-0312	-	○	
	1,75	0,312	0,412	VN 9800	8000	568000-032-0312	-	○	
	1,75	0,375	0,475	VN 9400	2000	562000-032-0375	-	○	
	1,75	0,375	0,475	VN 9800	8000	568000-032-0375	-	●	
	1,75	0,5	0,6	VN 9400	2000	562000-032-0500	-	○	
	1,75	0,5	0,6	VN 9800	8000	568000-032-0500	-	●	
	1,75	0,625	0,725	VN 9800	8000	568000-032-0625	-	○	
	1,75	0,75	0,85	VN 9400	2000	562000-032-0750	-	○	
	1,75	0,75	0,85	VN 9800	8000	568000-032-0750	-	●	
	1,75	1	1,1	VN 9800	8000	568000-032-1000	-	●	
	1,75	1,25	1,35	VN 9800	8000	568000-032-1250	-	○	
	1,876	0,312	0,412	VN 9800	8000	568062-032-0312	-	○	
2,125	1,875	0,187	0,287	VN 9800	8000	568000-034-0187	-	●	
	1,875	0,25	0,35	VN 9400	2000	562000-034-0250	-	○	
	1,875	0,375	0,475	VN 9800	8000	568000-034-0375	-	○	
	1,875	0,5	0,6	VN 9800	8000	568000-034-0500	-	○	
	1,875	0,75	0,85	VN 9800	8000	568000-034-0750	-	○	

D [inch]	d [inch]	H [inch]	L [inch]	Material	Design	Part No.	PU ¹⁾	US	EU
2,125	1,875	1	1,1	VN 9800	8000	568000-034-1000	-	○	
2,25	2	0,25	0,35	VN 9400	2000	562000-036-0250	-	○	
	2	0,25	0,35	VN 9800	8000	568000-036-0250	-	○	
	2	0,312	0,412	VN 9400	2000	562000-036-0312	-	○	
	2	0,312	0,412	VN 9800	8000	568000-036-0312	-	○	
	2	0,375	0,475	VN 9400	2000	562000-036-0375	-	○	
	2	0,375	0,475	VN 9800	8000	568000-036-0375	-	○	
	2	0,5	0,6	VN 9400	2000	562000-036-0500	-	○	
	2	0,5	0,6	VN 9800	8000	568000-036-0500	-	●	
	2	0,625	0,725	VN 9400	2000	562000-036-0625	-	○	
	2	0,625	0,725	VN 9800	8000	568000-036-0625	-	○	
	2	0,75	0,85	VN 9800	8000	568000-036-0750	-	○	
	2	1	1,1	VN 9400	2000	562000-036-1000	-	○	
	2	1	1,1	VN 9800	8000	568000-036-1000	-	●	
	2	1,25	1,35	VN 9800	8000	568000-036-1250	-	○	
2	1,5	1,6	VN 9400	2000	562000-036-1500	-	○		
2	1,5	1,6	VN 9800	8000	568000-036-1500	-	○		
2,375	2,125	0,187	0,287	VN 9800	8000	568000-038-0187	-	●	
	2,125	0,375	0,475	VN 9800	8000	568000-038-0375	-	○	
	2,125	0,5	0,6	VN 9800	8000	568000-038-0500	-	○	
2,5	2,25	0,187	0,287	VN 9800	8000	568000-040-0187	-	○	
	2,25	0,25	0,35	VN 9400	2000	562000-040-0250	-	○	
	2,25	0,25	0,35	VN 9800	8000	568000-040-0250	-	●	
	2,25	0,312	0,412	VN 9400	2000	562000-040-0312	-	○	
	2,25	0,312	0,412	VN 9800	8000	568000-040-0312	-	○	
	2,25	0,375	0,475	VN 9400	2000	562000-040-0375	-	○	
	2,25	0,375	0,475	VN 9800	8000	568000-040-0375	-	●	
	2,25	0,5	0,6	VN 9400	2000	562000-040-0500	-	○	
	2,25	0,5	0,6	VN 9800	8000	568000-040-0500	-	●	
	2,25	0,625	0,725	VN 9800	8000	568000-040-0625	-	○	
	2,25	0,75	0,85	VN 9400	2000	562000-040-0750	-	○	
	2,25	0,75	0,85	VN 9800	8000	568000-040-0750	-	●	
	2,25	1	1,1	VN 9800	8000	568000-040-1000	-	○	
	2,25	1,25	1,35	VN 9400	2000	562000-040-1250	-	○	
2,376	0,312	0,412	VN 9800	8000	568062-040-0312	-	○		
2,625	2,375	0,25	0,35	VN 9800	8000	568000-042-0250	-	○	
	2,375	0,312	0,412	VN 9800	8000	568000-042-0312	-	○	
	2,375	0,375	0,475	VN 9800	8000	568000-042-0375	-	○	
	2,375	0,75	0,85	VN 9800	8000	568000-042-0750	-	○	
2,75	2,5	0,187	0,287	VN 9400	2000	562000-044-0187	-	○	
	2,5	0,25	0,35	VN 9400	2000	562000-044-0250	-	○	
	2,5	0,25	0,35	VN 9800	8000	568000-044-0250	-	○	
	2,5	0,312	0,412	VN 9400	2000	562000-044-0312	-	○	
	2,5	0,312	0,412	VN 9800	8000	568000-044-0312	-	○	
	2,5	0,375	0,475	VN 9400	2000	562000-044-0375	-	○	
	2,5	0,375	0,475	VN 9800	8000	568000-044-0375	-	●	
	2,5	0,5	0,6	VN 9400	2000	562000-044-0500	-	○	
	2,5	0,5	0,6	VN 9800	8000	568000-044-0500	-	●	
	2,5	0,625	0,725	VN 9800	8000	568000-044-0625	-	○	
2,5	0,75	0,85	VN 9400	2000	562000-044-0750	-	○		

D [inch]	d [inch]	H [inch]	L [inch]	Material	Design	Part No.	PU ¹⁾	US	EU
2,75	2,5	0,75	0,85	VN 9800	8000	568000-044-0750	-	●	
	2,5	1	1,1	VN 9400	2000	562000-044-1000	-	○	
	2,5	1	1,1	VN 9800	8000	568000-044-1000	-	○	
	2,5	1,25	1,35	VN 9800	8000	568000-044-1250	-	○	
	2,5	1,5	1,6	VN 9400	2000	562000-044-1500	-	○	
	2,5	1,5	1,6	VN 9800	8000	568000-044-1500	-	○	
	2,5	1,75	1,85	VN 9800	8000	568000-044-1750	-	●	
2,875	2,625	0,25	0,35	VN 9800	8000	568000-046-0250	-	○	
	2,625	0,312	0,412	VN 9800	8000	568000-046-0312	-	○	
	2,625	0,5	0,6	VN 9800	8000	568000-046-0500	-	●	
	2,625	0,625	0,725	VN 9800	8000	568000-046-0625	-	○	
	2,625	1	1,1	VN 9800	8000	568000-046-1000	-	○	
3	2,75	0,187	0,287	VN 9800	8000	568000-048-0187	-	○	
	2,75	0,25	0,35	VN 9400	2000	562000-048-0250	-	○	
	2,75	0,25	0,35	VN 9800	8000	568000-048-0250	-	○	
	2,75	0,312	0,412	VN 9400	2000	562000-048-0312	-	○	
	2,75	0,312	0,412	VN 9800	8000	568000-048-0312	-	●	
	2,75	0,375	0,475	VN 9400	2000	562000-048-0375	-	○	
	2,75	0,375	0,475	VN 9800	8000	568000-048-0375	-	●	
	2,75	0,5	0,6	VN 9400	2000	562000-048-0500	-	○	
	2,75	0,5	0,6	VN 9800	8000	568000-048-0500	-	●	
	2,75	0,75	0,85	VN 9800	8000	568000-048-0750	-	●	
	2,75	1	1,1	VN 9800	8000	568000-048-1000	-	●	
	2,75	1,25	1,35	VN 9800	8000	568000-048-1250	-	○	
	2,75	2	2,1	VN 9800	8000	568000-048-2000	-	○	
3,125	2,875	0,312	0,412	VN 9800	8000	568000-050-0312	-	○	
	2,875	0,375	0,475	VN 9400	2000	562000-050-0375	-	○	
	2,875	0,375	0,475	VN 9800	8000	568000-050-0375	-	○	
	2,875	0,5	0,6	VN 9800	8000	568000-050-0500	-	○	
	2,875	1	1,1	VN 9800	8000	568000-050-1000	-	○	
3,25	3	0,25	0,35	VN 9400	2000	562000-052-0250	-	○	
	3	0,25	0,35	VN 9800	8000	568000-052-0250	-	●	
	3	0,312	0,412	VN 9800	8000	568000-052-0312	-	●	
	3	0,375	0,475	VN 9800	8000	568000-052-0375	-	●	
	3	0,5	0,6	VN 9400	2000	562000-052-0500	-	○	
	3	0,5	0,6	VN 9800	8000	568000-052-0500	-	●	
	3	0,625	0,725	VN 9400	2000	562000-052-0625	-	○	
	3	0,625	0,725	VN 9800	8000	568000-052-0625	-	○	
	3	0,75	0,85	VN 9800	8000	568000-052-0750	-	●	
	3	1	1,1	VN 9400	2000	562000-052-1000	-	○	
	3	1	1,1	VN 9800	8000	568000-052-1000	-	●	
	3	1,25	1,35	VN 9400	2000	562000-052-1250	-	○	
	3	1,5	1,6	VN 9400	2000	562000-052-1500	-	○	
	3	1,5	1,6	VN 9800	8000	568000-052-1500	-	●	
	3	2	2,1	VN 9800	8000	568000-052-2000	-	●	
3,375	3,126	0,312	0,412	VN 9800	8000	568062-052-0312	-	○	
	3,125	0,312	0,412	VN 9800	8000	568000-054-0312	-	○	
	3,125	0,375	0,475	VN 9800	8000	568000-054-0375	-	○	
	3,125	0,5	0,6	VN 9400	2000	562000-054-0500	-	○	
	3,125	0,5	0,6	VN 9800	8000	568000-054-0500	-	○	

D [inch]	d [inch]	H [inch]	L [inch]	Material	Design	Part No.	PU ¹⁾	US	EU
3,375	3,125	0,75	0,85	VN 9800	8000	568000-054-0750	-	○	
3,5	3,25	0,187	0,287	VN 9800	8000	568000-056-0187	-	○	
	3,25	0,25	0,35	VN 9400	2000	562000-056-0250	-	○	
	3,25	0,25	0,35	VN 9800	8000	568000-056-0250	-	○	
	3,25	0,312	0,412	VN 9400	2000	562000-056-0312	-	○	
	3,25	0,312	0,412	VN 9800	8000	568000-056-0312	-	●	
	3,25	0,375	0,475	VN 9800	8000	568000-056-0375	-	●	
	3,25	0,5	0,6	VN 9400	2000	562000-056-0500	-	○	
	3,25	0,5	0,6	VN 9800	8000	568000-056-0500	-	●	
	3,25	0,75	0,85	VN 9400	2000	562000-056-0750	-	○	
	3,25	0,75	0,85	VN 9800	8000	568000-056-0750	-	●	
	3,25	1	1,1	VN 9400	2000	562000-056-1000	-	○	
	3,25	1	1,1	VN 9800	8000	568000-056-1000	-	●	
	3,25	1,25	1,35	VN 9800	8000	568000-056-1250	-	○	
	3,25	1,5	1,6	VN 9400	2000	562000-056-1500	-	○	
	3,25	1,5	1,6	VN 9800	8000	568000-056-1500	-	○	
	3,376	0,312	0,412	VN 9800	8000	568062-056-0312	-	○	
3,625	3,375	0,312	0,412	VN 9800	8000	568000-058-0312	-	○	
	3,375	0,375	0,475	VN 9800	8000	568000-058-0375	-	○	
	3,375	0,5	0,6	VN 9800	8000	568000-058-0500	-	○	
3,75	3,5	0,25	0,35	VN 9800	8000	568000-060-0250	-	○	
	3,5	0,312	0,412	VN 9800	8000	568000-060-0312	-	●	
	3,5	0,375	0,475	VN 9800	8000	568000-060-0375	-	○	
	3,5	0,5	0,6	VN 9400	2000	562000-060-0500	-	○	
	3,5	0,5	0,6	VN 9800	8000	568000-060-0500	-	○	
	3,5	0,625	0,725	VN 9800	8000	568000-060-0625	-	○	
	3,5	0,75	0,85	VN 9400	2000	562000-060-0750	-	○	
	3,5	0,75	0,85	VN 9800	8000	568000-060-0750	-	●	
	3,5	1	1,1	VN 9400	2000	562000-060-1000	-	○	
	3,5	1	1,1	VN 9800	8000	568000-060-1000	-	○	
	3,5	1,25	1,35	VN 9400	2000	562000-060-1250	-	○	
	3,5	1,25	1,35	VN 9800	8000	568000-060-1250	-	●	
	3,5	1,5	1,6	VN 9400	2000	562000-060-1500	-	○	
	3,5	1,5	1,6	VN 9800	8000	568000-060-1500	-	○	
	3,5	1,75	1,85	VN 9800	8000	568000-060-1750	-	○	
	3,5	2	2,1	VN 9400	2000	562000-060-2000	-	○	
3,5	2	2,1	VN 9800	8000	568000-060-2000	-	●		
3,875	3,625	0,25	0,35	VN 9800	8000	568000-062-0250	-	○	
	3,625	0,312	0,412	VN 9800	8000	568000-062-0312	-	○	
	3,625	0,375	0,475	VN 9800	8000	568000-062-0375	-	○	
	3,625	0,625	0,725	VN 9800	8000	568000-062-0625	-	○	
	3,625	1	1,1	VN 9800	8000	568000-062-1000	-	○	
	3,625	2	2,1	VN 9400	2000	562000-062-2000	-	○	
4	3,75	0,25	0,35	VN 9400	2000	562000-064-0250	-	○	
	3,75	0,25	0,35	VN 9800	8000	568000-064-0250	-	●	
	3,75	0,312	0,412	VN 9800	8000	568000-064-0312	-	●	
	3,75	0,375	0,475	VN 9400	2000	562000-064-0375	-	○	
	3,75	0,375	0,475	VN 9800	8000	568000-064-0375	-	●	
	3,75	0,5	0,6	VN 9400	2000	562000-064-0500	-	○	
	3,75	0,5	0,6	VN 9800	8000	568000-064-0500	-	●	

D [inch]	d [inch]	H [inch]	L [inch]	Material	Design	Part No.	PU ¹⁾	US	EU
4	3,75	0,625	0,725	VN 9400	2000	562000-064-0625	-	○	
	3,75	0,625	0,725	VN 9800	8000	568000-064-0625	-	●	
	3,75	0,75	0,85	VN 9400	2000	562000-064-0750	-	○	
	3,75	0,75	0,85	VN 9800	8000	568000-064-0750	-	●	
	3,75	1	1,1	VN 9800	8000	568000-064-1000	-	●	
	3,75	1,5	1,6	VN 9400	2000	562000-064-1500	-	○	
	3,75	1,5	1,6	VN 9800	8000	568000-064-1500	-	●	
	3,75	2	2,1	VN 9400	2000	562000-064-2000	-	○	
	3,75	2	2,1	VN 9800	8000	568000-064-2000	-	○	
4,125	3,875	0,25	0,35	VN 9800	8000	568000-066-0250	-	○	
	3,875	0,375	0,475	VN 9800	8000	568000-066-0375	-	●	
	3,875	0,5	0,6	VN 9400	2000	562000-066-0500	-	○	
4,25	4	0,25	0,35	VN 9800	8000	568000-068-0250	-	○	
	4	0,312	0,412	VN 9800	8000	568000-068-0312	-	○	
	4	0,375	0,475	VN 9800	8000	568000-068-0375	-	○	
	4	0,5	0,6	VN 9400	2000	562000-068-0500	-	○	
	4	0,5	0,6	VN 9800	8000	568000-068-0500	-	●	
	4	0,625	0,725	VN 9400	2000	562000-068-0625	-	○	
	4	0,625	0,725	VN 9800	8000	568000-068-0625	-	○	
	4	0,75	0,85	VN 9400	2000	562000-068-0750	-	○	
	4	0,75	0,85	VN 9800	8000	568000-068-0750	-	●	
	4	1	1,1	VN 9400	2000	562000-068-1000	-	○	
	4	1	1,1	VN 9800	8000	568000-068-1000	-	●	
	4	1,25	1,35	VN 9400	2000	562000-068-1250	-	○	
	4	1,25	1,35	VN 9800	8000	568000-068-1250	-	○	
	4	1,5	1,6	VN 9400	2000	562000-068-1500	-	○	
	4	1,5	1,6	VN 9800	8000	568000-068-1500	-	●	
	4	1,75	1,85	VN 9800	8000	568000-068-1750	-	○	
4	2	2,1	VN 9800	8000	568000-068-2000	-	●		
4,375	4,125	0,25	0,35	VN 9800	8000	568000-070-0250	-	○	
	4,125	0,375	0,475	VN 9800	8000	568000-070-0375	-	○	
	4,125	0,5	0,6	VN 9800	8000	568000-070-0500	-	○	
	4,125	1	1,1	VN 9800	8000	568000-070-1000	-	○	
4,5	4,25	0,25	0,35	VN 9400	2000	562000-072-0250	-	○	
	4,25	0,25	0,35	VN 9800	8000	568000-072-0250	-	○	
	4,25	0,312	0,412	VN 9800	8000	568000-072-0312	-	○	
	4,25	0,375	0,475	VN 9800	8000	568000-072-0375	-	●	
	4,25	0,5	0,6	VN 9400	2000	562000-072-0500	-	○	
	4,25	0,5	0,6	VN 9800	8000	568000-072-0500	-	●	
	4,25	0,625	0,725	VN 9800	8000	568000-072-0625	-	○	
	4,25	0,75	0,85	VN 9800	8000	568000-072-0750	-	●	
	4,25	1	1,1	VN 9400	2000	562000-072-1000	-	○	
	4,25	1	1,1	VN 9800	8000	568000-072-1000	-	●	
	4,25	1,25	1,35	VN 9400	2000	562000-072-1250	-	○	
	4,25	1,25	1,35	VN 9800	8000	568000-072-1250	-	○	
	4,25	1,5	1,6	VN 9400	2000	562000-072-1500	-	○	
	4,25	1,5	1,6	VN 9800	8000	568000-072-1500	-	●	
	4,25	1,75	1,85	VN 9400	2000	562000-072-1750	-	○	
	4,25	2	2,1	VN 9800	8000	568000-072-2000	-	○	
4,625	4,375	0,375	0,475	VN 9800	8000	568000-074-0375	-	○	

D [inch]	d [inch]	H [inch]	L [inch]	Material	Design	Part No.	PU ¹⁾	US	EU
4,625	4,501	0,375	0,475	VN 9800	8000	5680620740375	-	○	
4,75	4,5	0,25	0,35	VN 9800	8000	5680000760250	-	●	
	4,5	0,312	0,412	VN 9800	8000	5680000760312	-	○	
	4,5	0,375	0,475	VN 9800	8000	5680000760375	-	●	
	4,5	0,5	0,6	VN 9800	8000	5680000760500	-	●	
	4,5	0,75	0,85	VN 9400	2000	5620000760750	-	○	
	4,5	0,75	0,85	VN 9800	8000	5680000760750	-	●	
	4,5	1	1,1	VN 9400	2000	5620000761000	-	○	
	4,5	1	1,1	VN 9800	8000	5680000761000	-	●	
	4,5	1,5	1,6	VN 9400	2000	5620000761500	-	○	
	4,5	1,5	1,6	VN 9800	8000	5680000761500	-	○	
4,5	1,75	1,85	VN 9400	2000	5620000761750	-	○		
4,5	2	2,1	VN 9800	8000	5680000762000	-	●		
4,875	4,625	0,5	0,6	VN 9800	8000	5680000780500	-	○	
5	4,75	0,25	0,35	VN 9800	8000	5680000800250	-	○	
	4,75	0,312	0,412	VN 9800	8000	5680000800312	-	○	
	4,75	0,375	0,475	VN 9400	2000	5620000800375	-	○	
	4,75	0,375	0,475	VN 9800	8000	5680000800375	-	●	
	4,75	0,5	0,6	VN 9400	2000	5620000800500	-	○	
	4,75	0,5	0,6	VN 9800	8000	5680000800500	-	●	
	4,75	0,625	0,725	VN 9400	2000	5620000800625	-	○	
	4,75	0,625	0,725	VN 9800	8000	5680000800625	-	○	
	4,75	0,75	0,85	VN 9400	2000	5620000800750	-	○	
	4,75	0,75	0,85	VN 9800	8000	5680000800750	-	●	
	4,75	0,875	0,975	VN 9800	8000	5680000800875	-	○	
	4,75	1	1,1	VN 9400	2000	5620000801000	-	○	
	4,75	1	1,1	VN 9800	8000	5680000801000	-	●	
	4,75	1,25	1,35	VN 9400	2000	5620000801250	-	○	
	4,75	1,25	1,35	VN 9800	8000	5680000801250	-	○	
	4,75	1,5	1,6	VN 9800	8000	5680000801500	-	○	
	4,75	1,75	1,85	VN 9400	2000	5620000801750	-	○	
	4,75	2	2,1	VN 9400	2000	5620000802000	-	○	
4,75	2	2,1	VN 9800	8000	5680000802000	-	○		
5,125	4,875	0,375	0,475	VN 9800	8000	5680000820375	-	○	
	4,875	1	1,1	VN 9400	2000	5620000821000	-	○	
	4,875	1	1,1	VN 9800	8000	5680000821000	-	○	
5,25	5	0,25	0,35	VN 9400	2000	5620000840250	-	○	
	5	0,25	0,35	VN 9800	8000	5680000840250	-	○	
	5	0,312	0,412	VN 9400	2000	5620000840312	-	○	
	5	0,312	0,412	VN 9800	8000	5680000840312	-	○	
	5	0,375	0,475	VN 9800	8000	5680000840375	-	●	
	5	0,5	0,6	VN 9800	8000	5680000840500	-	●	
	5	0,625	0,725	VN 9400	2000	5620000840625	-	○	
	5	0,625	0,725	VN 9800	8000	5680000840625	-	○	
	5	0,75	0,85	VN 9800	8000	5680000840750	-	○	
	5	1	1,1	VN 9800	8000	5680000841000	-	●	
	5	1,25	1,35	VN 9400	2000	5620000841250	-	○	
	5	1,25	1,35	VN 9800	8000	5680000841250	-	●	
	5	1,5	1,6	VN 9400	2000	5620000841500	-	○	
	5	1,5	1,6	VN 9800	8000	5680000841500	-	●	

D [inch]	d [inch]	H [inch]	L [inch]	Material	Design	Part No.	PU ¹⁾	US	EU	
5,25	5	1,75	1,85	VN 9400	2000	562000-084-1750	-	○		
	5	2	2,1	VN 9800	8000	568000-084-2000	-	○		
5,375	5,125	0,5	0,6	VN 9800	8000	568000-086-0500	-	○		
	5,25	0,187	0,287	VN 9400	2000	562000-088-0187	-	○		
	5,25	0,25	0,35	VN 9400	2000	562000-088-0250	-	○		
	5,25	0,25	0,35	VN 9800	8000	568000-088-0250	-	●		
	5,25	0,312	0,412	VN 9800	8000	568000-088-0312	-	●		
	5,25	0,375	0,475	VN 9800	8000	568000-088-0375	-	○		
	5,25	0,5	0,6	VN 9400	2000	562000-088-0500	-	○		
	5,25	0,5	0,6	VN 9800	8000	568000-088-0500	-	●		
	5,25	0,625	0,725	VN 9400	2000	562000-088-0625	-	○		
	5,25	0,625	0,725	VN 9800	8000	568000-088-0625	-	○		
	5,25	0,75	0,85	VN 9400	2000	562000-088-0750	-	○		
	5,25	0,75	0,85	VN 9800	8000	568000-088-0750	-	●		
	5,25	1	1,1	VN 9400	2000	562000-088-1000	-	○		
	5,25	1	1,1	VN 9800	8000	568000-088-1000	-	●		
	5,25	1,25	1,35	VN 9400	2000	562000-088-1250	-	○		
	5,25	1,25	1,35	VN 9800	8000	568000-088-1250	-	●		
5,5	5,25	1,5	1,6	VN 9400	2000	562000-088-1500	-	○		
	5,25	1,5	1,6	VN 9800	8000	568000-088-1500	-	○		
	5,25	2	2,1	VN 9400	2000	562000-088-2000	-	○		
	5,5	0,375	0,475	VN 9800	8000	568000-092-0375	-	●		
	5,5	0,5	0,6	VN 9400	2000	562000-092-0500	-	○		
	5,5	0,5	0,6	VN 9800	8000	568000-092-0500	-	○		
	5,5	0,75	0,85	VN 9800	8000	568000-092-0750	-	○		
	5,5	0,875	0,975	VN 9800	8000	568000-092-0875	-	○		
	5,5	1	1,1	VN 9800	8000	568000-092-1000	-	○		
	5,5	1,25	1,35	VN 9800	8000	568000-092-1250	-	●		
5,75	5,5	1,5	1,6	VN 9400	2000	562000-092-1500	-	○		
	5,5	1,5	1,6	VN 9800	8000	568000-092-1500	-	○		
	5,5	1,75	1,85	VN 9400	2000	562000-092-1750	-	○		
	5,5	1,75	1,85	VN 9800	8000	568000-092-1750	-	○		
	5,875	5,625	0,5	0,6	VN 9400	2000	562000-094-0500	-	○	
	6	5,75	0,25	0,35	VN 9400	2000	562000-096-0250	-	○	
		5,75	0,25	0,35	VN 9800	8000	568000-096-0250	-	○	
		5,75	0,312	0,412	VN 9800	8000	568000-096-0312	-	●	
		5,75	0,375	0,475	VN 9800	8000	568000-096-0375	-	●	
		5,75	0,5	0,6	VN 9400	2000	562000-096-0500	-	○	
5,75		0,5	0,6	VN 9800	8000	568000-096-0500	-	●		
5,75		0,625	0,725	VN 9400	2000	562000-096-0625	-	○		
5,75		0,625	0,725	VN 9800	8000	568000-096-0625	-	●		
5,75		0,75	0,85	VN 9400	2000	562000-096-0750	-	○		
5,75		0,75	0,85	VN 9800	8000	568000-096-0750	-	●		
5,75		1	1,1	VN 9400	2000	562000-096-1000	-	○		
5,75		1	1,1	VN 9800	8000	568000-096-1000	-	●		
5,75		1,25	1,35	VN 9400	2000	562000-096-1250	-	○		
5,75		1,25	1,35	VN 9800	8000	568000-096-1250	-	●		
5,75		1,5	1,6	VN 9800	8000	568000-096-1500	-	●		
5,75		2	2,1	VN 9400	2000	562000-096-2000	-	○		
5,75		2	2,1	VN 9800	8000	568000-096-2000	-	○		

D [inch]	d [inch]	H [inch]	L [inch]	Material	Design	Part No.	PU ¹⁾	US	EU
6	5,876	0,375	0,475	VN 9800	8000	568062-096-0375	–	○	
6,25	6	0,375	0,475	VN 9800	8000	568000-100-0375	–	○	
	6	0,5	0,6	VN 9400	2000	562000-100-0500	–	○	
	6	0,5	0,6	VN 9800	8000	568000-100-0500	–	○	
	6	0,625	0,725	VN 9800	8000	568000-100-0625	–	○	
	6	0,75	0,85	VN 9800	8000	568000-100-0750	–	●	
	6	1	1,1	VN 9400	2000	562000-100-1000	–	○	
	6	1	1,1	VN 9800	8000	568000-100-1000	–	●	
	6	1,25	1,35	VN 9800	8000	568000-100-1250	–	●	
	6	1,5	1,6	VN 9400	2000	562000-100-1500	–	○	
	6	1,5	1,6	VN 9800	8000	568000-100-1500	–	●	
	6	2	2,1	VN 9400	2000	562000-100-2000	–	○	
6	2	2,1	VN 9800	8000	568000-100-2000	–	○		
6,5	6,25	0,312	0,412	VN 9800	8000	568000-104-0312	–	○	
	6,25	0,5	0,6	VN 9800	8000	568000-104-0500	–	●	
	6,25	0,75	0,85	VN 9400	2000	562000-104-0750	–	○	
	6,25	0,75	0,85	VN 9800	8000	568000-104-0750	–	○	
	6,25	1	1,1	VN 9800	8000	568000-104-1000	–	●	
	6,25	1,25	1,35	VN 9800	8000	568000-104-1250	–	○	
	6,25	1,5	1,6	VN 9400	2000	562000-104-1500	–	○	
	6,25	1,5	1,6	VN 9800	8000	568000-104-1500	–	○	
	6,25	1,75	1,85	VN 9800	8000	568000-104-1750	–	○	
	6,25	2	2,1	VN 9400	2000	562000-104-2000	–	○	
6,25	2	2,1	VN 9800	8000	568000-104-2000	–	○		
6,75	6,5	0,75	0,85	VN 9400	2000	562000-108-0750	–	○	
	6,5	0,75	0,85	VN 9800	8000	568000-108-0750	–	○	
	6,5	1	1,1	VN 9400	2000	562000-108-1000	–	○	
	6,5	1	1,1	VN 9800	8000	568000-108-1000	–	○	
	6,5	1,5	1,6	VN 9400	2000	562000-108-1500	–	○	
	6,5	1,5	1,6	VN 9800	8000	568000-108-1500	–	●	
7	6,75	0,312	0,412	VN 9800	8000	568000-112-0312	–	○	
	6,75	0,375	0,475	VN 9400	2000	562000-112-0375	–	○	
	6,75	0,375	0,475	VN 9800	8000	568000-112-0375	–	●	
	6,75	0,5	0,6	VN 9400	2000	562000-112-0500	–	○	
	6,75	0,5	0,6	VN 9800	8000	568000-112-0500	–	●	
	6,75	0,625	0,725	VN 9400	2000	562000-112-0625	–	○	
	6,75	0,625	0,725	VN 9800	8000	568000-112-0625	–	○	
	6,75	0,75	0,85	VN 9400	2000	562000-112-0750	–	○	
	6,75	0,75	0,85	VN 9800	8000	568000-112-0750	–	●	
	6,75	1	1,1	VN 9400	2000	562000-112-1000	–	○	
	6,75	1	1,1	VN 9800	8000	568000-112-1000	–	●	
	6,75	1,25	1,35	VN 9400	2000	562000-112-1250	–	○	
	6,75	1,25	1,35	VN 9800	8000	568000-112-1250	–	○	
	6,75	1,5	1,6	VN 9400	2000	562000-112-1500	–	○	
	6,75	1,5	1,6	VN 9800	8000	568000-112-1500	–	○	
	6,75	2	2,1	VN 9800	8000	568000-112-2000	–	○	
7,25	7	0,5	0,6	VN 9400	2000	562000-116-0500	–	○	
	7	0,5	0,6	VN 9800	8000	568000-116-0500	–	○	
	7	0,75	0,85	VN 9800	8000	568000-116-0750	–	○	
	7	1	1,1	VN 9400	2000	562000-116-1000	–	○	

D [inch]	d [inch]	H [inch]	L [inch]	Material	Design	Part No.	PU ¹⁾	US	EU
7,25	7	1	1,1	VN 9800	8000	568000-116-1000	-	○	
	7	1,25	1,35	VN 9800	8000	568000-116-1250	-	○	
	7	1,5	1,6	VN 9400	2000	562000-116-1500	-	○	
	7	1,5	1,6	VN 9800	8000	568000-116-1500	-	○	
	7	2	2,1	VN 9400	2000	562000-116-2000	-	○	
7,375	7,125	1,25	1,35	VN 9400	2000	562000-118-1250	-	○	
7,5	7,25	0,5	0,6	VN 9800	8000	568000-120-0500	-	○	
	7,25	0,625	0,725	VN 9800	8000	568000-120-0625	-	○	
	7,25	0,75	0,85	VN 9400	2000	562000-120-0750	-	○	
	7,25	0,75	0,85	VN 9800	8000	568000-120-0750	-	○	
	7,25	1	1,1	VN 9400	2000	562000-120-1000	-	○	
	7,25	1	1,1	VN 9800	8000	568000-120-1000	-	○	
	7,25	1,25	1,35	VN 9400	2000	562000-120-1250	-	○	
	7,25	1,5	1,6	VN 9400	2000	562000-120-1500	-	○	
	7,25	1,5	1,6	VN 9800	8000	568000-120-1500	-	○	
7,75	7,5	0,25	0,35	VN 9800	8000	568000-124-0250	-	○	
	7,5	1	1,1	VN 9800	8000	568000-124-1000	-	○	
	7,5	1,5	1,6	VN 9800	8000	568000-124-1500	-	○	
8	7,75	0,312	0,412	VN 9800	8000	568000-128-0312	-	○	
	7,75	0,375	0,475	VN 9400	2000	562000-128-0375	-	○	
	7,75	0,375	0,475	VN 9800	8000	568000-128-0375	-	○	
	7,75	0,5	0,6	VN 9400	2000	562000-128-0500	-	○	
	7,75	0,5	0,6	VN 9800	8000	568000-128-0500	-	●	
	7,75	0,625	0,725	VN 9400	2000	562000-128-0625	-	○	
	7,75	0,625	0,725	VN 9800	8000	568000-128-0625	-	○	
	7,75	0,75	0,85	VN 9400	2000	562000-128-0750	-	○	
	7,75	0,75	0,85	VN 9800	8000	568000-128-0750	-	●	
	7,75	0,875	0,975	VN 9400	2000	562000-128-0875	-	○	
	7,75	0,875	0,975	VN 9800	8000	568000-128-0875	-	○	
	7,75	1	1,1	VN 9400	2000	562000-128-1000	-	○	
	7,75	1	1,1	VN 9800	8000	568000-128-1000	-	●	
	7,75	1,25	1,35	VN 9400	2000	562000-128-1250	-	○	
	7,75	1,25	1,35	VN 9800	8000	568000-128-1250	-	○	
	7,75	1,5	1,6	VN 9400	2000	562000-128-1500	-	○	
	7,75	1,5	1,6	VN 9800	8000	568000-128-1500	-	○	
	7,75	1,75	1,85	VN 9800	8000	568000-128-1750	-	○	
	7,75	2	2,1	VN 9800	8000	568000-128-2000	-	○	

STANGENFÜHRUNGSRINGE | ROD YATAKLAMA ELEMANLARI PROWADNICA TŁOCZYSKA | ШТОКОВЫЕ НАПРАВЛЯЮЩИЕ КОЛЬЦА

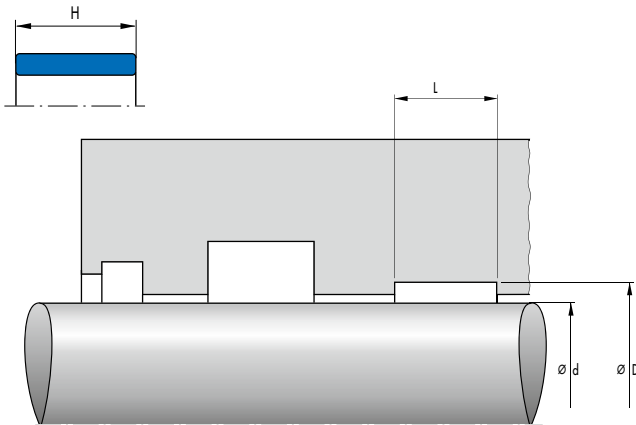

8001 2001

Wenn Sie Ihre Dichtung nicht finden können – Ihre Lösung auf Seite 12
 Aradığınız ürünü bulamadığınız takdirde – çözümünüz sayfa 12
 Jeżeli nie możecie Państwo znaleźć uszczelki – rozwiązanie znajduje się na stronie 12
 Вы не можете подобрать необходимое уплотнение? – Решение на странице 12

1) IP = Industriepackung | Endüstriyel ambalaj | Opakowania przemysłowe | Производственная тара
 SP = Einzelpackung | Tek bir Paket | Pojedyncze opakowanie | Single Pack

● Auf Lager | Stoklarda mevcuttur | Dostępne w magazynie | Имеется в наличии на складе
 ○ Auf Anfrage | Talep üzerine | Na zapytanie | По запросу

d [inch]	D [inch]	H [inch]	L [inch]	Material	Design	Part No.	PU ¹⁾	US	EU
0,75	1	0,25	0,35	VN 9800	8001	568001-016-0250	–	○	
	1	0,375	0,475	VN 9800	8001	568001-016-0375	–	○	
1	1,124	0,375	0,475	VN 9800	8001	568062-R018-0375	–	○	
	1,124	0,5	0,6	VN 9800	8001	568062-R018-0500	–	○	
	1,25	0,375	0,475	VN 9800	8001	568001-020-0375	–	○	
	1,25	0,5	0,6	VN 9400	2001	562001-020-0500	–	○	
	1,25	0,5	0,6	VN 9800	8001	568001-020-0500	–	○	
	1,25	0,75	0,85	VN 9800	8001	568001-020-0750	–	○	
1,125	1,249	0,25	0,35	VN 9800	8001	568062-R020-0250	–	○	
	1,375	0,25	0,35	VN 9800	8001	568001-022-0250	–	●	
	1,375	0,375	0,475	VN 9800	8001	568001-022-0375	–	○	
	1,375	0,5	0,6	VN 9800	8001	568001-022-0500	–	○	
1,25	1,374	0,5	0,6	VN 9800	8001	568062-R022-0500	–	○	
	1,374	1	1,1	VN 9800	8001	568062-R022-1000	–	○	
	1,5	0,187	0,287	VN 9800	8001	568001-024-0187	–	○	
	1,5	0,25	0,35	VN 9400	2001	562001-024-0250	–	○	
	1,5	0,25	0,35	VN 9800	8001	568001-024-0250	–	●	
	1,5	0,375	0,475	VN 9800	8001	568001-024-0375	–	●	
	1,5	0,5	0,6	VN 9400	2001	562001-024-0500	–	○	
	1,5	0,5	0,6	VN 9800	8001	568001-024-0500	–	●	
	1,5	0,75	0,85	VN 9400	2001	562001-024-0750	–	○	
	1,5	0,75	0,85	VN 9800	8001	568001-024-0750	–	○	
	1,5	1	1,1	VN 9800	8001	568001-024-1000	–	●	
1,375	1,625	0,5	0,6	VN 9800	8001	568001-026-0500	–	○	
	1,625	0,75	0,85	VN 9800	8001	568001-026-0750	–	○	
1,5	1,624	0,5	0,6	VN 9800	8001	568062-R026-0500	–	○	
	1,624	1	1,1	VN 9800	8001	568062-R026-1000	–	○	
	1,75	0,25	0,35	VN 9400	2001	562001-028-0250	–	○	
	1,75	0,25	0,35	VN 9800	8001	568001-028-0250	–	●	
	1,75	0,375	0,475	VN 9800	8001	568001-028-0375	–	○	

d [inch]	D [inch]	H [inch]	L [inch]	Material	Design	Part No.	PU ¹⁾	US	EU
1,5	1,75	0,5	0,6	VN 9400	2001	562001-028-0500	-	○	
	1,75	0,5	0,6	VN 9800	8001	568001-028-0500	-	●	
	1,75	0,625	0,725	VN 9800	8001	568001-028-0625	-	○	
	1,75	0,75	0,85	VN 9400	2001	562001-028-0750	-	○	
	1,75	0,75	0,85	VN 9800	8001	568001-028-0750	-	○	
	1,75	1	1,1	VN 9400	2001	562001-028-1000	-	○	
	1,75	1	1,1	VN 9800	8001	568001-028-1000	-	●	
	1,75	1,25	1,35	VN 9800	8001	568001-028-1250	-	○	
	1,75	1,5	1,6	VN 9400	2001	562001-028-1500	-	○	
	1,75	1,5	1,6	VN 9800	8001	568001-028-1500	-	○	
1,625	1,875	0,625	0,725	VN 9800	8001	568001-030-0625	-	○	
1,75	1,874	0,5	0,6	VN 9800	8001	568062-R030-0500	-	○	
	2	0,375	0,475	VN 9400	2001	562001-032-0375	-	○	
	2	0,5	0,6	VN 9400	2001	562001-032-0500	-	○	
	2	0,5	0,6	VN 9800	8001	568001-032-0500	-	●	
	2	0,75	0,85	VN 9800	8001	568001-032-0750	-	●	
	2	1	1,1	VN 9400	2001	562001-032-1000	-	○	
	2	1	1,1	VN 9800	8001	568001-032-1000	-	●	
	2	1,5	1,6	VN 9400	2001	562001-032-1500	-	○	
1,875	2,125	0,5	0,6	VN 9800	8001	568001-034-0500	-	○	
	2,125	0,625	0,725	VN 9800	8001	568001-034-0625	-	○	
	2,125	0,75	0,85	VN 9400	2001	562001-034-0750	-	○	
2	2,25	0,375	0,475	VN 9800	8001	568001-036-0375	-	●	
	2,25	0,5	0,6	VN 9400	2001	562001-036-0500	-	○	
	2,25	0,5	0,6	VN 9800	8001	568001-036-0500	-	●	
	2,25	0,625	0,725	VN 9800	8001	568001-036-0625	-	●	
	2,25	0,75	0,85	VN 9800	8001	568001-036-0750	-	●	
	2,25	0,875	0,975	VN 9800	8001	568001-036-0875	-	○	
	2,25	1	1,1	VN 9400	2001	562001-036-1000	-	○	
	2,25	1	1,1	VN 9800	8001	568001-036-1000	-	●	
	2,25	1,25	1,35	VN 9400	2001	562001-036-1250	-	○	
	2,25	1,25	1,35	VN 9800	8001	568001-036-1250	-	●	
	2,25	1,5	1,6	VN 9800	8001	568001-036-1500	-	●	
	2,25	2,374	1	1,1	VN 9800	8001	568062-R038-1000	-	○
2,5		0,25	0,35	VN 9800	8001	568001-040-0250	-	○	
2,5		0,375	0,475	VN 9800	8001	568001-040-0375	-	○	
2,5		0,5	0,6	VN 9800	8001	568001-040-0500	-	●	
2,5		0,75	0,85	VN 9800	8001	568001-040-0750	-	●	
2,5		1	1,1	VN 9400	2001	562001-040-1000	-	○	
2,5		1	1,1	VN 9800	8001	568001-040-1000	-	●	
2,5		1,5	1,6	VN 9800	8001	568001-040-1500	-	○	
2,5		2	2,1	VN 9800	8001	568001-040-2000	-	○	
2,375	2,625	0,5	0,6	VN 9800	8001	568001-042-0500	-	○	
2,5	2,75	0,375	0,475	VN 9800	8001	568001-044-0375	-	○	
	2,75	0,5	0,6	VN 9400	2001	562001-044-0500	-	○	
	2,75	0,5	0,6	VN 9800	8001	568001-044-0500	-	●	
	2,75	0,625	0,725	VN 9800	8001	568001-044-0625	-	●	
	2,75	0,75	0,85	VN 9800	8001	568001-044-0750	-	●	
	2,75	1	1,1	VN 9400	2001	562001-044-1000	-	○	
	2,75	1	1,1	VN 9800	8001	568001-044-1000	-	●	

d [inch]	D [inch]	H [inch]	L [inch]	Material	Design	Part No.	PU ¹⁾	US	EU
2,5	2,75	1,25	1,35	VN 9800	8001	568001-044-1250	-	●	
	2,75	1,5	1,6	VN 9400	2001	562001-044-1500	-	○	
	2,75	1,5	1,6	VN 9800	8001	568001-044-1500	-	○	
2,625	2,875	0,5	0,6	VN 9800	8001	568001-046-0500	-	○	
	2,875	1	1,1	VN 9800	8001	568001-046-1000	-	○	
2,75	3	0,5	0,6	VN 9800	8001	568001-048-0500	-	●	
	3	0,75	0,85	VN 9400	2001	562001-048-0750	-	○	
	3	0,75	0,85	VN 9800	8001	568001-048-0750	-	○	
	3	1	1,1	VN 9800	8001	568001-048-1000	-	○	
	3	1,5	1,6	VN 9800	8001	568001-048-1500	-	○	
2,875	3,125	0,375	0,475	VN 9400	2001	562001-050-0375	-	○	
	3,125	0,5	0,6	VN 9800	8001	568001-050-0500	-	○	
3	3,25	0,375	0,475	VN 9400	2001	562001-052-0375	-	○	
	3,25	0,5	0,6	VN 9400	2001	562001-052-0500	-	○	
	3,25	0,5	0,6	VN 9800	8001	568001-052-0500	-	●	
	3,25	0,75	0,85	VN 9400	2001	562001-052-0750	-	○	
	3,25	0,75	0,85	VN 9800	8001	568001-052-0750	-	●	
	3,25	1	1,1	VN 9400	2001	562001-052-1000	-	○	
	3,25	1	1,1	VN 9800	8001	568001-052-1000	-	○	
	3,25	1,25	1,35	VN 9800	8001	568001-052-1250	-	●	
	3,25	1,5	1,6	VN 9800	8001	568001-052-1500	-	●	
	3,25	2	2,1	VN 9400	2001	562001-052-2000	-	○	
	3,25	2	2,1	VN 9800	8001	568001-052-2000	-	●	
	3,25	3,5	0,5	0,6	VN 9800	8001	568001-056-0500	-	○
3,5		0,75	0,85	VN 9800	8001	568001-056-0750	-	○	
3,5		1	1,1	VN 9400	2001	562001-056-1000	-	○	
3,5		1	1,1	VN 9800	8001	568001-056-1000	-	●	
3,375	3,625	0,5	0,6	VN 9800	8001	568001-058-0500	-	○	
3,5	3,75	0,187	0,287	VN 9800	8001	568001-060-0187	-	○	
	3,75	0,5	0,6	VN 9800	8001	568001-060-0500	-	●	
	3,75	0,625	0,725	VN 9800	8001	568001-060-0625	-	○	
	3,75	0,75	0,85	VN 9400	2001	562001-060-0750	-	○	
	3,75	0,75	0,85	VN 9800	8001	568001-060-0750	-	●	
	3,75	1	1,1	VN 9400	2001	562001-060-1000	-	○	
	3,75	1	1,1	VN 9800	8001	568001-060-1000	-	●	
	3,75	1,25	1,35	VN 9800	8001	568001-060-1250	-	○	
	3,75	1,5	1,6	VN 9400	2001	562001-060-1500	-	○	
	3,75	1,5	1,6	VN 9800	8001	568001-060-1500	-	○	
	3,75	1,75	1,85	VN 9800	8001	568001-060-1750	-	○	
	3,75	2	2,1	VN 9400	2001	562001-060-2000	-	○	
3,75	4	0,5	0,6	VN 9800	8001	568001-064-0500	-	●	
	4	1	1,1	VN 9800	8001	568001-064-1000	-	●	
3,875	4,125	0,375	0,475	VN 9400	2001	562001-066-0375	-	○	
4	4,25	0,187	0,287	VN 9800	8001	568001-068-0187	-	○	
	4,25	0,5	0,6	VN 9800	8001	568001-068-0500	-	○	
	4,25	0,625	0,725	VN 9800	8001	568001-068-0625	-	○	
	4,25	0,75	0,85	VN 9800	8001	568001-068-0750	-	○	
	4,25	1	1,1	VN 9400	2001	562001-068-1000	-	○	
	4,25	1	1,1	VN 9800	8001	568001-068-1000	-	●	

d [inch]	D [inch]	H [inch]	L [inch]	Material	Design	Part No.	PU ¹⁾	US	EU
4	4,25	1,25	1,35	VN 9800	8001	568001-068-1250	-	●	
	4,25	1,5	1,6	VN 9400	2001	562001-068-1500	-	○	
	4,25	1,5	1,6	VN 9800	8001	568001-068-1500	-	●	
	4,25	1,75	1,85	VN 9800	8001	568001-068-1750	-	●	
	4,25	2	2,1	VN 9400	2001	562001-068-2000	-	○	
	4,25	2	2,1	VN 9800	8001	568001-068-2000	-	○	
4,25	4,5	1	1,1	VN 9800	8001	568001-072-1000	-	○	
	4,5	1,25	1,35	VN 9800	8001	568001-072-1250	-	○	
	4,5	1,5	1,6	VN 9400	2001	562001-072-1500	-	○	
	4,5	1,5	1,6	VN 9800	8001	568001-072-1500	-	○	
	4,5	1,75	1,85	VN 9800	8001	568001-072-1750	-	○	
4,375	4,625	0,5	0,6	VN 9800	8001	568001-074-0500	-	○	
	4,625	1	1,1	VN 9400	2001	562001-074-1000	-	○	
	4,625	1	1,1	VN 9800	8001	568001-074-1000	-	○	
4,5	4,75	0,5	0,6	VN 9400	2001	562001-076-0500	-	○	
	4,75	0,5	0,6	VN 9800	8001	568001-076-0500	-	○	
	4,75	0,75	0,85	VN 9400	2001	562001-076-0750	-	○	
	4,75	0,75	0,85	VN 9800	8001	568001-076-0750	-	○	
	4,75	1	1,1	VN 9800	8001	568001-076-1000	-	○	
	4,75	1,5	1,6	VN 9400	2001	562001-076-1500	-	○	
	4,75	1,5	1,6	VN 9800	8001	568001-076-1500	-	○	
	4,75	1,75	1,85	VN 9800	8001	568001-076-1750	-	○	
4,75	5	0,5	0,6	VN 9800	8001	568001-080-0500	-	○	
	5	0,75	0,85	VN 9800	8001	568001-080-0750	-	○	
	5	1	1,1	VN 9800	8001	568001-080-1000	-	○	
	5	1,25	1,35	VN 9800	8001	568001-080-1250	-	●	
	5	1,5	1,6	VN 9800	8001	568001-080-1500	-	○	
5	5,25	0,5	0,6	VN 9800	8001	568001-084-0500	-	○	
	5,25	0,75	0,85	VN 9800	8001	568001-084-0750	-	●	
	5,25	1	1,1	VN 9800	8001	568001-084-1000	-	○	
	5,25	1,25	1,35	VN 9800	8001	568001-084-1250	-	○	
	5,25	1,5	1,6	VN 9800	8001	568001-084-1500	-	○	
	5,25	1,75	1,85	VN 9800	8001	568001-084-1750	-	○	
	5,25	2	2,1	VN 9800	8001	568001-084-2000	-	○	
5,5	5,75	0,375	0,475	VN 9800	8001	568001-092-0375	-	○	
	5,75	0,5	0,6	VN 9800	8001	568001-092-0500	-	○	
	5,75	1	1,1	VN 9400	2001	562001-092-1000	-	○	
	5,75	1	1,1	VN 9800	8001	568001-092-1000	-	○	
	5,75	1,5	1,6	VN 9400	2001	562001-092-1500	-	○	
	5,75	1,5	1,6	VN 9800	8001	568001-092-1500	-	○	
	5,75	1,75	1,85	VN 9400	2001	562001-092-1750	-	○	
6	6,25	0,5	0,6	VN 9800	8001	568001-100-0500	-	○	
	6,25	0,75	0,85	VN 9800	8001	568001-100-0750	-	○	
	6,25	1	1,1	VN 9800	8001	568001-100-1000	-	●	
	6,25	1,5	1,6	VN 9400	2001	562001-100-1500	-	○	
	6,25	1,5	1,6	VN 9800	8001	568001-100-1500	-	○	
6,25	6,5	0,75	0,85	VN 9800	8001	568001-104-0750	-	○	
6,5	6,75	0,5	0,6	VN 9800	8001	568001-108-0500	-	○	
	6,75	0,75	0,85	VN 9800	8001	568001-108-0750	-	○	

d [inch]	D [inch]	H [inch]	L [inch]	Material	Design	Part No.	PU ¹⁾	US	EU
6,5	6,75	1	1,1	VN 9800	8001	568001-108-1000	-	○	
	6,75	1,25	1,35	VN 9800	8001	568001-108-1250	-	○	
6,625	6,875	1,5	1,6	VN 9800	8001	568001-110-1500	-	○	
6,75	7	1	1,1	VN 9400	2001	562001-112-1000	-	○	
	7	1	1,1	VN 9800	8001	568001-112-1000	-	○	
7	7,25	0,5	0,6	VN 9800	8001	568001-116-0500	-	○	
	7,25	1	1,1	VN 9800	8001	568001-116-1000	-	○	
7,5	7,75	0,5	0,6	VN 9800	8001	568001-124-0500	-	○	
	7,75	0,75	0,85	VN 9800	8001	568001-124-0750	-	○	
	7,75	1	1,1	VN 9800	8001	568001-124-1000	-	○	

MONTAGEHILFE | MONTAJ YARDIM POMOC MONTAŻOWA | РУКОВОДСТВО ПО МОНТАЖУ

DE FÜHRUNGSELEMENTE

Was nützt die beste Dichtung, wenn sie nicht richtig eingebaut oder beim Einbau beschädigt wird? Damit dies nicht passiert, stellt Ihnen Freudenberg Sealing Technologies eine maßgeschneiderte Palette von Montagewerkzeugen zur Verfügung. Die einwandfreie Montage ist entscheidend für die Leistungsfähigkeit und Standzeit einer Dichtung und stellt damit ein wesentliches Qualitätsmerkmal dar. Mit den Einbauhilfen von Freudenberg Sealing Technologies

- vermeiden Sie grundlegende Einbaufehler,
- vermeiden Sie Beschädigungen der Dichtkante bei der Montage,
- erhöhen Sie die Standzeit der Dichtung,
- sparen Sie Zeit und Kosten

Das Ablängen

Viele Kunden nutzen Führungsbänder und schneiden ihre Stangenführungen je nach Bedarf passend zurecht. Hierbei ist höchste Sorgfalt angebracht. Das richtige Werkzeug hilft: Die Ablängvorrichtung von Freudenberg Sealing Technologies. Sie ermöglicht nicht nur gerade Schnitte; sie lässt sich auch auf fünf verschiedene Schnittwinkel für exakte schräge Schnitte einstellen. Auf Wunsch ist ein Stufenschnittmesser erhältlich.

- Den gewünschten Winkel am Messerhalter einstellen.
- Das Band einlegen, die Führungsschiene justieren und arretieren, den Bandanfang ablängen.
- Ist die benötigte Bandlänge bestimmt, den Gegenwinkel an der Skala positionieren.
- Das Führungsband an den Gegenwinkel anlegen, die Führungsschiene feststellen und das Band abtrennen.

Die Montage

Bei der professionellen Montage von Stangenführungen helfen Konushülse und Pusher aus dem Werkzeugsortiment von Freudenberg Sealing Technologies:

- Den Konus auf den Stangenkopf aufsetzen.
- Das Führungselement einsetzen.
- Das Führungselement mit dem Pusher in die Nut schieben.

TR YATAKLAMA ELEMANLARI

Doğru montaj yapılmayan ve ya montaj sırasında hasar gören sızdırmazlık elemanları en iyi sızdırmazlık elemanları olsa bile neye yarar? Bunun olmaması için Freudenberg Sealing Technologies size özel hazırlanmış montaj takımları sunmaktadır. Bir sızdırmazlık elemanının performansı ve dayanım süresi için kusursuz montaj çok önemlidir ve önemli bir kalite özelliğidir. Freudenberg Sealing Technologies montaj yardımcıları ile

- temel montaj hatalarından kaçınabilirsiniz.
- montaj sırasında sızdırmazlık dudağına zarar vermeyi önlersiniz.
- sızdırmazlık elemanının dayanım süresini artırırsınız
- zamandan ve maliyetten tasarruf etmiş olursunuz.

Uzunluğunu ayarlama

Birçok müşteri yataklama şeritlerini kullanırken rod yataklamalarını ihtiyaca göre kesmektedir. Bu işlemde çok dikkatli davranmak gerekir: Freudenberg Sealing Technologies'e ait yataklama elemanı kesme düzeneği bu konuda işinize yardımcı olur. Sadece düz kesimlerin yapılmasına değil aynı zamanda seçebileceğiniz 5 farklı açıda kusursuz eğik kesimler için de size kesme imkanı verir. İstek üzerine L kesik bıçağı temin edilebilir.

- Bıçak tutucusundan istenilen açığı ayarlayınız.
- Bandı yerleştiriniz, kılavuz rayını ayarlayınız ve sabitleyiniz, bant başlangıcını kısaltınız.
- İstenilen band uzunluğu belirlendikten sonra skaladan karşı açığı konumlandırınız.
- Kılavuz bandı, karşı açığa dayayınız, kılavuz rayı sabitleyiniz ve bandı kesiniz.

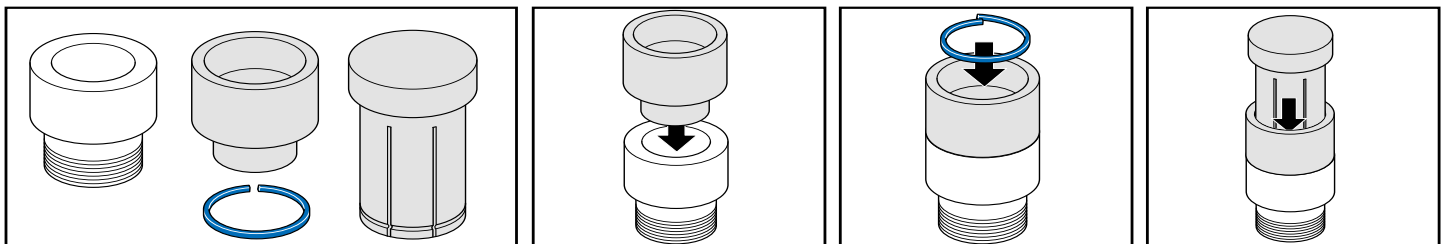

Einbau Führungselemente | Yataklama elemanları montajı | Instalacja elementów prowadzących | Монтаж направляющих элементов

Montaj

Rod sızdırmazlık elemanlarının profesyonel montajı için Freudenberg Sealing Technologies'in konik kovan ve itici takımları yardımcı araçlardır:

- Koniyi roda yerleştiriniz
- Yataklama elemanını takınız.
- Yataklama elemanını itici ile yuva içerisine itiniz.

PL PROWADNICE

Cóż jest warta nawet najlepsza uszczelka, jeśli nie zostanie prawidłowo zainstalowana lub ulegnie uszkodzeniu podczas montażu? Aby tak się nie stało, firma Freudenberg Sealing Technologies udostępnia Państwu specjalistyczny zestaw narzędzi montażowych. Prawidłowy montaż jest kluczowym czynnikiem wpływającym na funkcjonowanie uszczelniania oraz jego długą żywotność. Dzięki narzędziom do montażu oferowanym przez firmę Freudenberg Sealing Technologies

- unika się podstawowych błędów montażowych,
- unika się uszkodzenia krawędzi uszczelniających podczas montażu,
- wydłuża się żywotność uszczelnienia,
- w konsekwencji oszczędza się czas i ogranicza koszty.

Cięcie na wymiar

Wielu użytkowników korzysta z taśm prowadzących docinając je do pożądanej długości. Niezbędne jest zachowanie ogromnej staranności, a stosowanie maszyny do cięcia taśm prowadzących z firmy Freudenberg Sealing Technologies ułatwia zadanie. Za pomocą maszyny można wykonać nie tylko prostopadłe cięcie, ale również ukośne pod jednym z pięciu różnych kątów. Maszynka jest dostępna na zamówienie.

- Wybrać kąt pod którym ma nastąpić cięcie
- Zamocować w maszynie taśmę prowadzącą, następnie wykonać pierwsze cięcie
- Po odmierzeniu pożądanej długości prowadnicy, wybrać kąt przeciwny do kąta pod którym nastąpiło pierwsze cięcie
- Zamocować taśmę prowadzącą w maszynie, wykonać cięcie

Montaż

W celu wykonania prawidłowego montażu prowadnicy tłoczyska potrzebny jest stożek montażowy oraz popychacz z Firmy Freudenberg Sealing Technologies:

- Umieścić stożek na głowicy tłoczyska
- Wprowadzić prowadnicę
- Za pomocą popychacza umieścić prowadnicę w rowku

RU НАПРАВЛЯЮЩИЕ ЭЛЕМЕНТЫ

Какая польза от самого лучшего уплотнения, если оно неправильно установлено или повреждено при монтаже? Чтобы этого не случилось, «Фройденберг Силинг Технолоджис» предлагает Вам ассортимент монтажных инструментов. Безупречный монтаж в решающей степени влияет на эффективность и срок службы уплотнения и является, тем самым, существенным показателем качества. Монтажные инструменты «Фройденберг Силинг Технолоджис» позволяют Вам

- не допускать основных ошибок при монтаже,
- избегать при монтаже повреждения уплотняющей кромки,
- продлить срок службы уплотнения,
- сэкономить время и затраты.

Подрезка под размер

Многие заказчики используют направляющие ленты. Подрезка направляющих под требуемый размер осуществляется по месту. При выполнении данной операции необходимо действовать с особой тщательностью, а правильный инструмент облегчит выполнение работы: инструмент для подрезки направляющих лент от «Фройденберг Силинг Технолоджис». Инструмент для подрезки позволяет делать не только прямые разрезы; он также может регулироваться для выполнения точных косых разрезов под пятью различными углами. Нож для подрезки лесенкой поставляется по запросу.

- Выставить на держателе ножа требуемый угол
- Вставить ленту, отрегулировать и закрепить направляющую планку, подрезать начало ленты под размер
- После того, как определена требуемая длина ленты, выставить на шкале противоположный угол.
- Приложить направляющую ленту к противоположному углу, закрепить направляющую планку и отрезать ленту.

Монтаж

Для профессионального монтажа штоковых направляющих используются конусная втулка и толкатель, которые предлагаются «Фройденберг Силинг Технолоджис»:

- Установить конус на головку штока
- Вставить направляющий элемент
- Протолкнуть толкателем направляющий элемент в канавку

PROFILE FÜR OSZILLIERENDE ANWENDUNG SALINIMLI UYGULAMALAR İÇİN PROFİLLER PROFILE DO APLIKACJI OSCYLACYJNYCH ПРОФИЛИ ДЛЯ КОЛЕБАТЕЛЬНЫХ ДВИЖЕНИЙ

Nutringe | Nutring Pierścienie typu U | Манжеты

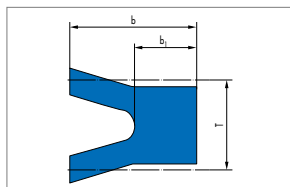

DE Nutringe werden als Kolben- oder Stangendichtung gefertigt, extrudiert und am Stoß geklebt. Nutringe aus NBR und FKM sind auch am Stoß vulkanisierbar.

TR Nutringler, Piston ve Rod sızdırmazlık uygulamalarında ekstruzyon yöntemiyle şerit olarak üretilip uçları yapıştırılır. NBR ve FKM (Viton) malzemelerinde vulkanizasyon yapılabilir.

PL Pierścienie typu U, są produkowane, wytłaczane i klejone w celu zastosowania ich jako uszczelnień tłoków oraz tłoczysek. Pierścienie typu U wykonane z NBR oraz Vitonu są dostępne w wersji zwulkanizowanej.

RU Манжеты, как уплотнения для поршней или штоков, изготавливаются методом экструдирования и импульсного склеивания встык. Манжеты из NBR и FKM также вулканизируются встык.

Gegenringe für Nutringe | Nutring destek halkası Pierścienie wspornikowe dla pierścieni typu U | Опорные кольца для манжет

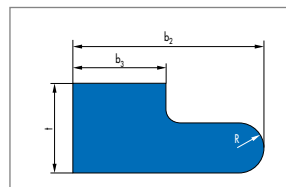

DE Gegenringe dienen zur Fixierung und verhindern eine axiale Bewegung der Nutringe, durch welche die Dichtkanten an den Dichtlippen beschädigt werden können. Die Herstellung erfolgt mittels Strangpressen. Die Gegenringe werden stets als Meterware geliefert.

TR Nutring destek halkaları, Nutringin Yuva içerisinde aksel yönde hareketini engelleyerek Nutring sızdırmazlık dudaklarının zarar görmesini önler. Nutring destek halkaları metre halinde tedarik edilir.

PL Pierścienie są stosowane do mocowania i zabezpieczania przed osiowymi ruchami pierścieni typu U, które mogą doprowadzić do zniszczenia krawędzi wargi uszczelniającej. Pierścienie są zawsze dostarczane z metra

RU Опорные кольца служат для фиксации и препятствуют осевым перемещениям манжеты, из-за которых уплотняющие кромки на рабочей кромке могут повредиться. Они изготавливаются методом штранг-прессования. Опорные кольца поставляются метрами.

Sonstige Spezialprofile | Diğer özel profiller Inne specjalne profile | Прочие специальные профили

DE Profile können wie folgt hergestellt und geliefert werden:

- Meterware
 - mit/ohne Eigenkrümmung
- Profilstücke
 - konfektioniert nach Kundenwunsch
(bis 2000 mm ohne Eigenkrümmung möglich)
- Profilringe
 - am Stoß geklebt oder stoßvulkanisiert.

TR Profiller alttaki şekilde tedarik edilebilir:

- Metre halinde isteğe göre eğilmiş veya eğilmemiş
- Profiller müşteri talebine göre
(2000 mm kadar eğilmemiş olarak) üretilir.
- Profiller uçlarından yapıştırılır veya vulkanize edilir.

PL Następujące profile mogą zostać wyprodukowane i dostarczone

- Z metra
 - Z/bez krzywizny
- Wybór profili
 - Zgodnie ze specyfikacją klienta
(do 2000 mm bez krzywizny)
- Pierścienie
 - klejone lub wulkanizowane

RU Профили могут изготавливаться и отпускаться следующим образом:

- погонными метрами
 - с или без естественной кривизны
- профильными изделиями
 - по желанию заказчика
(до 2000 мм возможно без естественной кривизны)
- профильными кольцами
 - импульсное склеивание или вулканизация встык.

Profildüsen | Profil üretim ucu (kalıbı) Profile | Профильные насадки

DE Folgend eine Auswahl aus den etwa 3500 vorrätigen Profildüsen. Auf Anfrage werden für spezielle Ausführungen individuelle Werkzeuge entwickelt und gefertigt.

TR Altteki Profiller, stoğumuzda bulunan 3500 farklı profillerden bazılarınıdır. Müşterilerimizin isteğine göre yeni Profil uçları tasarlanabilir.

PL Wybór 3500 profili dostępnych na magazynie. Na życzenie może zostać opracowane i wyprodukowane oprzyrządowanie do produkcji specjalnych geometrii

RU Далее приводится выборка из 3500 имеющихся профильных насадок. По вашему запросу может быть разработана и изготовлена индивидуальная оснастка.

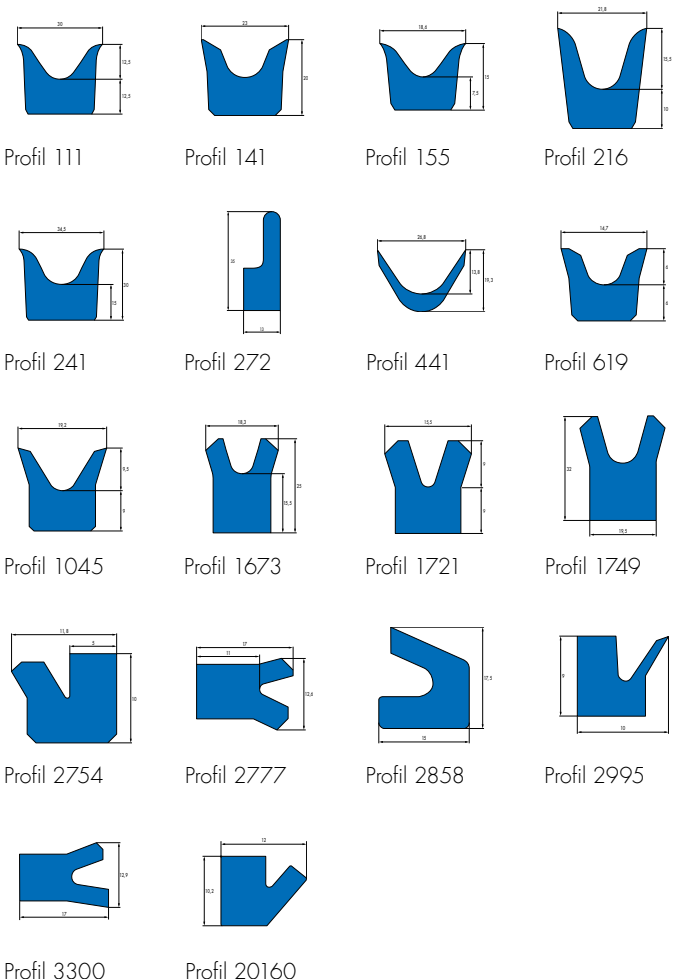

Type	M 15		M 16		M 17	M 19
Standard	ISO		ISO		ISO	ISO
Shape						
Compound	PTFE / NBR GM201 / B241	PTFE / FKM GM201 / K670	PTFE / NBR GM201 / B241	PTFE / FKM GM201 / K670	NBR 80 NBR B246 BHNBR B3B248	NBR 80 NBR B246 BHNBR B4B285
 MPa						
 Celsius						
 m/s						
Applications						

Bitte beachten Sie unsere allgemeinen Konstruktionshinweise in → Technisches Handbuch
 Daha detaylı montaj bilgisi için → Bkz. Technical Manual
 W celu zaznajomienia się z ogólnymi uwagami proszę skorzystać z Instrukcji
 Общие технические рекомендации см. → Техническое руководство

DICHTUNGEN FÜR DREH- UND SCHWENKBEWEGUNGEN | DÖNME VE ILERİ-GERİ HAREKET İÇİN SIZDIRMAZLIK ELEMANLARI
 USZCZELNIENIA DO RUCHÓW OBROTOWYCH I WYCHYLNÝCH | УПЛОТНЕНИЯ ДЛЯ ВРАЩАТЕЛЬНЫХ И ПОВОРОТНЫХ ДВИЖЕНИЙ

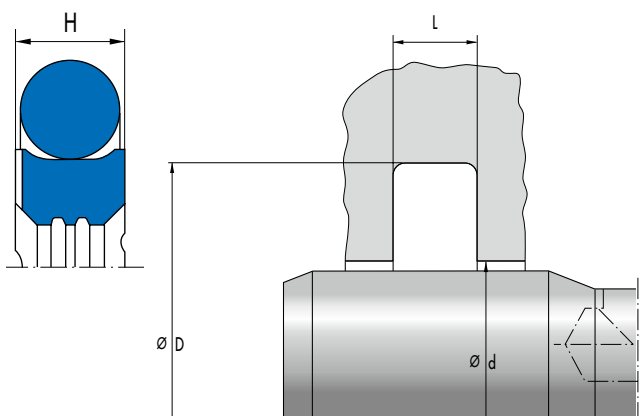

Wenn Sie Ihre Dichtung nicht finden können – Ihre Lösung auf Seite 12
 Aradığınız ürünü bulamadığınız takdirde – çözümünüz sayfa 12
 Jeżeli nie możecie Państwo znaleźć uszczelki – rozwiązanie znajduje się na stronie 12
 Вы не можете подобрать необходимое уплотнение? – Решение на странице 12

1) IP = Industriepackung | Endüstriyel ambalaj | Opakowania przemysłowe | Производственная тара
 SP = Einzelpackung | Tek bir Paketi | Pojedyncze opakowanie | Single Pack

● Auf Lager | Stoklarda mevcuttur | Dostępne w magazynie | Имеется в наличии на складе
 ○ Auf Anfrage | Talep üzerine | Na zapytanie | По запросу

d [mm]	D [mm]	H [mm]	L [mm]	Material	Design	Part No.	PU ¹⁾	US	EU
10	18	6	6,5	80 NBR B246	M 17	24024279	IP		●
20	27,5	2,9	3,2	PTFE GM201	M 15	24336291	IP		●
	28	6	6,5	80 NBR B246	M 17	24024285	IP		●
22	30	6	6,5	80 NBR B246	M 17	24024286	IP		●
25	32,5	2,9	3,2	PTFE GM201	M 15	24342634	–		○
	35	7,5	8	80 NBR B246	M 17	24024287	IP		●
28	35,5	2,9	3,2	PTFE GM201	M 15	24342635	–		○
	38	7,5	8	80 NBR B246	M 17	24024288	–		○
30	37,5	2,9	3,2	PTFE GM201	M 15	24332459	–		○
	40	7,5	8	80 NBR B246	M 17	24024289	IP		●
	41	3,9	4,2	PTFE GM201	M 15	24260303	–		○
32	41	3,9	4,2	PTFE GM201	M 15	24263153	–		○
	39,5	2,9	3,2	PTFE GM201	M 15	24342636	–		○
34,1	42	7,5	8	80 NBR B246	M 17	24024290	IP		●
	40	2	2,2	PTFE GM201	M 16	24344591	–		○
35	45	7,5	8	80 NBR B246	M 17	24024291	IP		●
	46	3,9	4,2	PTFE GM201	M 15	24288862	–		○
35,1	40	2	2,2	PTFE GM201	M 16	24344600	–		○
	46	7,5	8	80 NBR B246	M 17	24024292	–		○
36	47	3,9	4,2	PTFE GM201	M 15	24261511	–		○
	45	2,9	3,2	PTFE GM201	M 16	24344592	–		○
37,5	45	2,9	3,2	PTFE GM201	M 16	24344601	–		○
	51	3,9	4,2	PTFE GM201	M 15	24260912	–		○
40	52	7,5	8	80 NBR B246	M 17	24024212	IP		●
	55,5	5,9	6,3	PTFE GM201	M 15	24263148	–		○
42	54	7,5	8	80 NBR B246	M 17	24024293	IP		●
42,5	50	2,9	3,2	PTFE GM201	M 16	24344593	–		○
	50	2,9	3,2	PTFE GM201	M 16	24344602	–		○
45	56	3,9	4,2	PTFE GM201	M 15	24342638	IP		●
	57	7,5	8	80 NBR B246	M 17	24024294	IP		●

Dichtungen für Dreh- und Schwenkbewegungen | Dönme ve ileri-geri hareket için sızdırmazlık elemanları
 Uszczelnienia do ruchów obrotowych i wychylnych | Уплотнения для вращательных и поворотных движений

d [mm]	D [mm]	H [mm]	L [mm]	Material	Design	Part No.	PU ¹⁾	US	EU
47,5	55	2,9	3,2	PTFE GM201	M 16	24344594	-		○
	55	2,9	3,2	PTFE GM201	M 16	24344603	-		○
50	61	3,9	4,2	PTFE GM201	M 15	24244043	IP		●
	61	3,9	4,2	PTFE GM201	M 15	24260913	-		○
	65,5	5,9	6,3	PTFE GM201	M 15	24332753	-		○
52,5	60	2,9	3,2	PTFE GM201	M 16	24344595	-		○
	60	2,9	3,2	PTFE GM201	M 16	24344604	-		○
54	65	3,9	4,2	PTFE GM201	M 16	24351853	-		○
55	66	3,9	4,2	PTFE GM201	M 15	24339230	-		○
	67	7,5	8	80 NBR B246	M 17	24024296	IP		●
55,5	63	2,9	3,2	PTFE GM201	M 16	24344596	-		○
	63	2,9	3,2	PTFE GM201	M 16	24344605	-		○
56	67	3,9	4,2	PTFE GM201	M 15	24342640	-		○
	68	7,5	8	80 NBR B246	M 17	24024297	IP		●
60	71	3,9	4,2	PTFE GM201	M 15	24344647	-		○
	72	9	10	80 NBR B246	M 19	24069210	-		○
	75	10	11	80 NBR B246	M 17	24024298	IP		●
62,5	70	2,9	3,2	PTFE GM201	M 16	24344597	-		○
	70	2,9	3,2	PTFE GM201	M 16	24344606	-		○
63	74	3,9	4,2	PTFE GM201	M 15	24342641	-		○
	78	10	11	80 NBR B246	M 17	24024299	-		○
65	76	3,9	4,2	PTFE GM201	M 15	24379352	-		○
	80	10	11	80 NBR B246	M 17	24024300	IP		●
	80,5	6,3	6,3	PTFE GM201	M 15	24262462	-		○
67,5	75	2,9	3,2	PTFE GM201	M 16	24378533	-		○
69	80	3,9	4,2	PTFE GM201	M 16	24275277	-		○
	80	3,9	4,2	PTFE GM201	M 16	24344607	-		○
70	81	3,9	4,2	PTFE GM201	M 15	24261512	IP		●
	85	10	11	80 NBR B246	M 17	24024301	IP		●
	85	10	11	80 NBR B246	M 19	24067432	-		○
75	86	3,9	4,2	PTFE GM201	M 15	24274587	-		○
	90	10	11	80 NBR B246	M 17	24024302	IP		●
	90,5	5,9	6,3	PTFE GM201	M 15	24379083	-		○
79	90	3,9	4,2	PTFE GM201	M 16	24344598	-		○
	90	3,9	4,2	PTFE GM201	M 16	24344608	-		○
80	91	3,9	4,2	PTFE GM201	M 15	24269431	IP		●
	95	10	11	80 NBR B246	M 17	24024303	IP		●
	95	10	11	80 NBR B246	M 19	24235577	IP		●
	95,5	5,9	6,3	PTFE GM201	M 15	24268439	-		○
	95,5	5,9	6,3	PTFE GM201	M 15	24379084	-		○
84	95	3,9	4,2	PTFE GM201	M 16	24376140	-		○
85	100	10	11	80 NBR B246	M 17	24024304	IP		●
	100,5	5,9	6,3	PTFE GM201	M 15	24374977	-		○
87	98	3,9	4,2	PTFE GM201	M 16	24359814	-		○
89	100	3,9	4,2	PTFE GM201	M 16	24344628	-		○
	100	3,9	4,2	PTFE GM201	M 16	24344633	-		○
90	101	3,9	4,2	PTFE GM201	M 15	24295714	-		○
	105,5	5,9	6,3	PTFE GM201	M 15	24269461	IP		●
	110	12	13	80 NBR B246	M 17	24024305	IP		●
	110	12	13	80 NBR B246	M 19	24103500	-		○

d [mm]	D [mm]	H [mm]	L [mm]	Material	Design	Part No.	PU ¹⁾	US	EU
94	105	3,9	4,2	PTFE GM201	M 16	24360325	-		○
	105	3,9	4,2	PTFE GM201	M 16	24362662	-		○
95	112	10	11	80 NBR B246	M 19	24065060	IP		●
99	110	3,9	4,2	PTFE GM201	M 16	24344625	-		○
	110	3,9	4,2	PTFE GM201	M 16	24344629	-		○
100	111	3,9	4,2	PTFE GM201	M 15	24334450	IP		●
	115,5	5,9	6,3	PTFE GM201	M 15	24372600	-		○
	115,5	5,9	6,3	PTFE GM201	M 15	24379085	-		○
	120	12	13	80 NBR B246	M 17	24024306	IP		●
	120	12	13	80 NBR B246	M 19	24103501	IP		●
110	121	3,9	4,2	PTFE GM201	M 15	24342642	-		○
	125,5	5,9	6,3	PTFE GM201	M 15	24269828	-		○
	130	12	13	80 NBR B246	M 17	24024307	IP		●
	130	12	13	80 NBR B246	M 19	24103502	IP		●
114	125	3,9	4,2	PTFE GM201	M 16	24261557	-		○
	125	3,9	4,2	PTFE GM201	M 16	24344630	-		○
115	126	3,9	4,2	PTFE GM201	M 15	24275310	-		○
	135	12	13	80 NBR B246	M 17	24024308	IP		●
120	131	3,9	4,2	PTFE GM201	M 15	24244324	-		○
124,5	140	5,9	6,3	PTFE GM201	M 16	24265781	-		○
125	136	3,9	4,2	PTFE GM201	M 15	24342643	-		○
	140,5	5,9	6,3	PTFE GM201	M 15	24264533	-		○
	145	12	13	80 NBR B246	M 17	24026976	IP		●
	145	12	13	80 NBR B246	M 19	24103504	IP		●
129,5	145	5,9	6,3	PTFE GM201	M 16	24295612	-		○
130	150	10	11	80 NBR B246	M 19	24091083	-		○
134,5	150	5,9	6,3	PTFE GM201	M 16	24344626	-		○
135,5	150	5,9	6,3	PTFE GM201	M 16	24344655	-		○
140	151	3,9	4,2	PTFE GM201	M 15	24342644	-		○
	155,5	5,9	6,3	PTFE GM201	M 15	24275177	-		○
	160	12	13	80 NBR B246	M 17	24024310	IP		●
	160	12	13	80 NBR B246	M 19	24103505	-		○
144,5	160	5,9	6,3	PTFE GM201	M 16	24344627	-		○
	160	5,9	6,3	PTFE GM201	M 16	24344632	-		○
149,5	165	5,9	6,3	PTFE GM201	M 16	24380085	-		○
150	161	3,9	4,2	PTFE GM201	M 15	24342645	-		○
	165,5	5,9	6,3	PTFE GM201	M 15	24275214	-		○
	170	12	13	80 NBR B246	M 19	24139281	-		○
	175	15	16	80 NBR B246	M 17	24024311	IP		●
154,5	170	5,9	6,3	PTFE GM201	M 16	24362008	-		○
160	171	3,9	4,2	PTFE GM201	M 15	24332460	-		○
	175,5	5,9	6,3	PTFE GM201	M 15	24345425	-		○
	185	15	16	80 NBR B246	M 17	24024312	IP		●
	185	15	16	80 NBR B219	M 19	24080888	-		○
164,5	180	5,9	6,3	PTFE GM201	M 16	24344599	-		○
	180	5,9	6,3	PTFE GM201	M 16	24344609	-		○
170	190	12	13	80 NBR B246	M 17	24024266	-		○
180	191	3,9	4,2	PTFE GM201	M 15	24265195	-		○
	191	3,9	4,2	PTFE GM201	M 15	24360171	-		○
	195,5	5,9	6,3	PTFE GM201	M 15	24258164	-		○

Dichtungen für Dreh- und Schwenkbewegungen | Dönme ve ileri-geri hareket için sızdırmazlık elemanları
 Uszczelnienia do ruchów obrotowych i wychylnych | Уплотнения для вращательных и поворотных движений

d [mm]	D [mm]	H [mm]	L [mm]	Material	Design	Part No.	PU ¹⁾	US	EU
180	205	15	16	80 NBR B246	M 17	24024313	IP		●
	205	15	16	80 NBR B246	M 19	24068319	-		○
184,5	200	5,9	6,3	PTFE GM201	M 16	24333651	-		○
	200	5,9	6,3	PTFE GM201	M 16	24344610	-		○
190	201	3,9	4,2	PTFE GM201	M 15	531984	-		○
200	215,5	5,9	6,3	PTFE GM201	M 15	24342646	-		○
	225	15	16	80 NBR B246	M 17	24024314	IP		●
	225	15	16	80 NBR B219	M 19	24103506	-		○
204,5	220	5,9	6,3	PTFE GM201	M 16	24330686	-		○
	220	5,9	6,3	PTFE GM201	M 16	24344611	-		○
220	235,5	5,9	6,3	PTFE GM201	M 15	24342647	-		○
224,5	240	5,9	6,3	PTFE GM201	M 16	24331499	-		○
225	255	17,5	19	80 NBR B246	M 17	24127447	-		○
234,5	250	5,9	6,3	PTFE GM201	M 16	24331860	-		○
	250	5,9	6,3	PTFE GM201	M 16	24344612	-		○
240	255,5	5,9	6,3	PTFE GM201	M 15	24300256	-		○
250	265,5	5,9	6,3	PTFE GM201	M 15	24258166	-		○
	270	15,3	17	80 NBR B246	M 17	24024270	IP		●
254,5	270	5,9	6,3	PTFE GM201	M 16	24350021	-		○
264,5	280	5,9	6,3	PTFE GM201	M 16	24377949	-		○
280	301	7,7	8,1	PTFE GM201	M 15	24361776	-		○
	301	7,7	8,1	PTFE GM201	M 15	24362271	-		○
284,5	300	5,9	6,3	PTFE GM201	M 16	24369438	-		○
285	306	7,7	8,1	PTFE GM201	M 15	24360172	-		○
289	310	7,7	8,1	PTFE GM201	M 16	24341182	-		○
299	320	7,7	8,1	PTFE GM201	M 16	49004641	-		○
305	326	7,7	8,1	PTFE GM201	M 15	24360876	-		○
310	340	17,5	19	80 NBR B246	M 17	24035509	-		○
314,5	330	5,9	6,3	PTFE GM201	M 16	24331955	-		○
320	344,5	7,7	8,1	PTFE GM201	M 15	24348407	-		○
	345	12	13	80 NBR B246	M 17	24078636	-		○
335	356	7,7	8,1	PTFE GM201	M 15	24269406	-		○
335,5	360	7,7	8,1	PTFE GM201	M 16	24366844	-		○
339	360	7,7	8,1	PTFE GM201	M 16	531983	-		○
350	374,5	7,7	8,1	PTFE GM201	M 15	24352373	-		○
360	378	12	13	80 NBR B246	M 17	24029629	-		○
	384,5	7,7	8,1	PTFE GM201	M 15	49006745	-		○
364	385	7,7	8,1	PTFE GM201	M 16	24334111	-		○
375	396	7,7	8,1	PTFE GM201	M 15	533623	-		○
375,5	400	7,7	8,1	PTFE GM201	M 16	24363097	-		○
380	400	15	16	80 NBR B246	M 17	24174996	-		○
	401	8,1	8,1	PTFE GM201	M 15	49011805	-		○
	404,5	7,7	8,1	PTFE GM201	M 15	24377578	-		○
400	424,5	7,7	8,1	PTFE GM201	M 15	24257070	-		○
440	460	12	13	80 NBR B246	M 17	24137980	-		○
460	484,5	7,7	8,1	PTFE GM201	M 15	24373000	-		○
475	499,5	7,7	8,1	PTFE GM201	M 15	24296663	-		○
475,5	500	7,7	8,1	PTFE GM201	M 16	24363098	-		○
500	520	15	16	80 NBR B246	M 17	24063830	-		○
530	551	7,7	8,1	PTFE GM201	M 15	24349316	-		○

d [mm]	D [mm]	H [mm]	L [mm]	Material	Design	Part No.	PU ¹⁾	US	EU
605,5	630	7,7	8,1	PTFE GM201	M 16	24363099	-		○
652	680	9,1	9,5	PTFE GM201	M 16	24357188	-		○
680	708	9,5	9,5	PTFE GM201	M 15	24261907	-		○
	720	24	25	80 NBR B246	M 17	24143612	-		○
682	710	9,1	9,5	PTFE GM201	M 16	24374718	-		○
750	790	24	26	80 NBR B246	M 17	24136568	-		○
752	780	9,1	9,5	PTFE GM201	M 16	24361922	-		○
772	800	9,1	9,5	PTFE GM201	M 16	24374719	-		○
792	820	9,1	9,5	PTFE GM201	M 16	24356201	-		○
872	900	9,1	9,5	PTFE GM201	M 16	24345423	-		○
1000	1028	9,5	9,5	PTFE GM201	M 15	24377339	-		○

Type	PU 82	PU 83	SRC	
Standard	ISO	ISO	ISO	
Shape				
Compound	Polyurethane 95 AU V142 94 AU 925	Polyurethane 95 AU V142 94 AU 925	Polyurethane 95 AU V142	
Applications				

Bitte beachten Sie unsere allgemeinen Konstruktionshinweise in → Technisches Handbuch

Daha detaylı montaj bilgisi için → Bkz. Technical Manual

W celu zaznajomienia się z ogólnymi uwagami proszę skorzystać z Instrukcji

Общие технические рекомендации см. → Техническое руководство

STATISCHE DICHTUNGEN INNENDICHTEND | İÇ ÇAP İÇİN STATİK SIZDIRMAZLIK ELEMANLARI
 USZCZELNIENIA STATYCZNE USZCZELNIAJĄCE OD WEWNATRZ | СТАТИЧЕСКИЕ УПЛОТНЕНИЯ ПО ВНУТРЕННЕМУ ДИАМЕТРУ

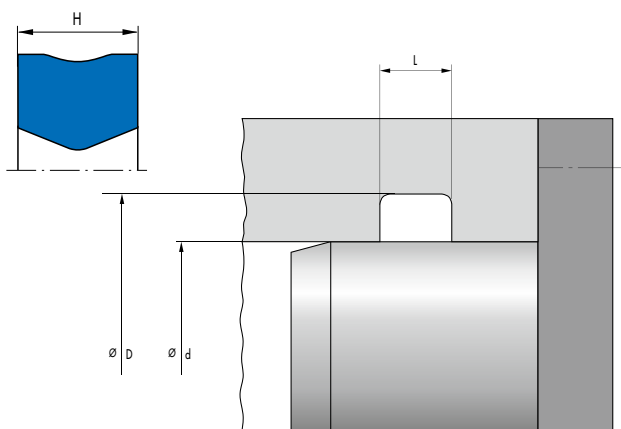

Wenn Sie Ihre Dichtung nicht finden können – Ihre Lösung auf Seite 12
 Aradığınız ürünü bulamadığınız takdirde – çözümünüz sayfa 12
 Jeżeli nie możecie Państwo znaleźć uszczelki – rozwiązanie znajduje się na stronie 12
 Вы не можете подобрать необходимое уплотнение? – Решение на странице 12

1) IP = Industriepackung | Endüstriyel ambalaj | Opakowania przemysłowe | Производственная тара
 SP = Einzelpackung | Tek bir Paketi | Pojedyncze opakowanie | Single Pack

● Auf Lager | Stoklarda mevcuttur | Dostępne w magazynie | Имеется в наличии на складе
 ○ Auf Anfrage | Talep üzerine | Na zapytanie | По запросу

d [mm]	D [mm]	H [mm]	L [mm]	Material	Design	Part No.	PU ¹⁾	US	EU
16	21	4,20	5	95 AU V142	PU 82	24359080	–		○
	22	4,30	5	95 AU V142	PU 82	24287685	–		○
20	24	4,10	4,80	95 AU V142	PU 82	49000714	–		○
25	29,20	4,10	5	95 AU V142	PU 82	49014546	–		○
	33	5,70	6,50	95 AU V142	PU 82	24377325	–		○
30	34	4,10	4,80	95 AU V142	PU 82	49000656	–		○
35	39,50	3,80	4,50	95 AU V142	PU 82	24361201	–		○
40	46	2,40	3	95 AU V142	PU 82	24354007	–		○
45	49,80	5,40	6,30	95 AU V142	PU 82	49065621	IP		●
	54,80	5,40	6,30	95 AU V142	PU 82	49065620	IP		●
50	58	5,60	6,40	95 AU V142	PU 82	24362417	–		○
	60	9,20	10,50	95 AU V142	PU 82	49000499	–		○
55	59,80	5,40	6,30	95 AU V142	PU 82	49065619	IP		●
60	65,50	4,50	5,20	95 AU V142	PU 82	24368756 40422499	IP SP		● ●
	70	75,60	5,30	6,20	95 AU V142	PU 82	49004012	–	
80	85	2,60	3,20	95 AU V142	PU 82	49022415	–		○
	90	9,20	10,50	95 AU V142	PU 82	49000500	–		○
90	110	10,80	12,30	95 AU V142	PU 82	49018307	–		○
105	112,80	5	5,80	95 AU V142	PU 82	24354748	–		○
110	117	4	4,70	95 AU V142	PU 82	24367583	–		○
117	123,10	4,90	5,80	95 AU V142	PU 82	24245387	–		○
120	140	10,80	12,30	95 AU V142	PU 82	49018308	–		○
136	141,90	4,90	5,80	95 AU V142	PU 82	24250882	–		○
140	145,90	4,90	5,80	95 AU V142	PU 82	49009024	–		○
149,70	165,50	11,10	12,70	95 AU V142	PU 82	49006190	–		○
160	168,60	7,80	9	95 AU V142	PU 82	24370625	–		○
170	176,30	4,90	5,80	95 AU V142	PU 82	24250879	–		○
180	188,60	7,80	9	95 AU V142	PU 82	49002910	IP		●
190	201,60	10,70	12,30	94 AU 925	PU 82	49003461	–		○
200	208,60	7,80	9	95 AU V142	PU 82	533208	–		○

d [mm]	D [mm]	H [mm]	L [mm]	Material	Design	Part No.	PU ¹⁾	US	EU
210	221,60	10,70	12,30	94 AU 925	PU 82	24379224	-		○
230	239,10	5,20	9	95 AU V142	PU 82	49039425	-		○
240	249,40	6,10	6,10	95 AU V142	PU 82	49002429	-		○
250	258,60	7,80	9	95 AU V142	PU 82	49004491	-		○
	278,20	7,40	8,50	95 AU V142	PU 82	24360461	-		○
270	278,60	7,80	9	94 AU 925	PU 82	49016834	-		○
	281,60	10,40	12	95 AU V142	PU 82	49004133	-		○
275	286,60	10,70	12,30	94 AU 925	PU 82	529839	-		○
280	320	17,90	20	94 AU 925	PU 82	49009097	-		○
285	296,60	10,70	12,30	94 AU 925	PU 82	49000401	-		○
	309,80	7,10	8,20	95 AU V142	PU 82	49028621	-		○
300	311,60	10,40	12	95 AU V142	PU 82	49002713	-		○
	311,60	10,70	12,30	95 AU V142	PU 82	49006854	-		○
310	321,60	10,70	12,30	94 AU 925	PU 82	49023886	-		○
320	333,40	8,60	10	95 AU V142	PU 82	24369684	-		○
330	341,60	10,70	12,30	94 AU 925	PU 82	532554	-		○
360	371,60	10,70	12,30	94 AU 925	PU 82	49005757	-		○
400	411,60	10,70	12,30	94 AU 925	PU 82	49014554	-		○
440	451,60	10,70	12,30	94 AU 925	PU 82	531798	-		○
510	523,40	11,80	13,60	95 AU 925	PU 82	49035523	-		○
540	553,40	9,30	10,80	94 AU 925	PU 82	49001311	-		○
600	614,20	11,20	12,80	94 AU 925	PU 82	49026666	-		○
790	803,60	9,20	10,70	94 AU 925	PU 82	527748	-		○
840	853,60	9,20	10,70	94 AU 925	PU 82	527749	-		○
1120	1137	14,40	16,30	94 AU 925	PU 82	533599	-		○
1155	1177,40	12,40	14	94 AU 925	PU 82	24371571	-		○
1320	1337	14,40	16,30	94 AU 925	PU 82	49001112	-		○

STATISCHE DICHTUNGEN AUSSENDICHTEND | DIŞ ÇAP İÇİN STATİK SIZDIRMAZLIK ELEMANLARI
USZCZELNIENIA STATYCZNE USZCZELNIAJĄCE OD ZEWNĄTRZ | СТАТИЧЕСКИЕ УПЛОТНЕНИЯ ПО НАРУЖНОМУ ДИАМЕТРУ

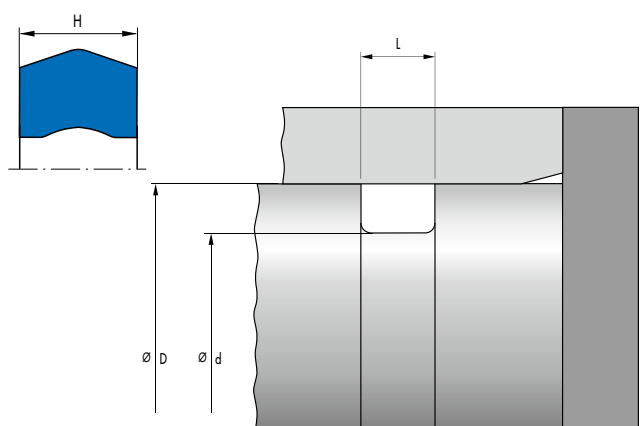

PU 83

Wenn Sie Ihre Dichtung nicht finden können – Ihre Lösung auf Seite 12
Aradığınız ürünü bulamadığınız takdirde – çözümüüz sayfa 12
Jeżeli nie możecie Państwo znaleźć uszczelki – rozwiązanie znajduje się na stronie 12
Вы не можете подобрать необходимое уплотнение? – Решение на странице 12

1) IP = Industriepackung | Endüstriyel ambalaj | Opakowania przemysłowe | Производственная тара
SP = Einzelpackung | Tek bir Paketi | Pojedyncze opakowanie | Single Pack

● Auf Lager | Stoklarda mevcuttur | Dostępne w magazynie | Имеется в наличии на складе
○ Auf Anfrage | Talep üzerine | Na zapytanie | По запросу

D [mm]	d [mm]	H [mm]	L [mm]	Material	Design	Part No.	PU ¹⁾	US	EU
40	32,80	2,80	3,40	95 AU V142	PU 83	24367566	IP		●
	35,20	5,40	6,30	95 AU V142	PU 83	49065681	IP		●
45	40,20	5,40	6,30	95 AU V142	PU 83	49065618	IP		●
	42,20	5	5,80	95 AU V142	PU 83	24334142 40422462	IP SP		● ●
50	42,20	5	5,80	95 AU V142	PU 83	40422462 24334142	IP SP		● ●
	44,40	5,30	6,20	95 AU V142	PU 83	532203	–		○
	44,60	5,20	6,20	95 AU V142	PU 83	49055450	IP		●
60	52,20	5	5,80	95 AU V142	PU 83	24327617 40422459	IP SP		● ●
	52,20	5	5,80	95 AU V142	PU 83	40422459 24327617	IP SP		● ●
	54	5,30	6,20	95 AU V142	PU 83	49001027	–		○
	54,60	5,50	6,50	95 AU V142	PU 83	24380802	–		○
65	57,20	5	5,80	95 AU V142	PU 83	24327636 40422460	IP SP		● ●
	57,20	5	5,80	95 AU V142	PU 83	40422460 24327636	IP SP		● ●
70	64,40	5,20	6,20	95 AU V142	PU 83	532201	–		○
75	69,60	5,50	6,50	95 AU V142	PU 83	24380803 40422519	IP SP		● ●
	69,60	5,50	6,50	95 AU V142	PU 83	40422519 24380803	IP SP		● ●
80	70	6,90	8	95 AU V142	PU 83	532538	–		○
81	73,20	5	5,80	95 AU V142	PU 83	24295885 40422408	IP SP		● ●
	73,20	5	5,80	95 AU V142	PU 83	40422408 24295885	IP SP		● ●
85	80,80	4,20	5	95 AU V142	PU 83	24269861	–		○
90	80,10	6,70	7,80	95 AU V142	PU 83	24362668 40422495	IP SP		● ●
	80,10	6,70	7,80	95 AU V142	PU 83	40422495 24362668	IP SP		● ●
95	86,40	7,80	9	95 AU V142	PU 83	49018330	–		○

D [mm]	d [mm]	H [mm]	L [mm]	Material	Design	Part No.	PU ¹⁾	US	EU
95,50	87,70	5	5,80	95 AU V142	PU 83	24293063	–		○
	90	7,30	7,80	95 AU V142	PU 83	40422493 24362292	IP SP		● ●
100	90,10	6,70	7,80	95 AU V142	PU 83	24362292 40422493	IP SP		● ●
	91,40	7,80	9	95 AU V142	PU 83	24379356	–		○
	94,40	5,20	6,20	95 AU V142	PU 83	532202	–		○
105	95,10	6,70	7,80	95 AU V142	PU 83	24359847 40422492	IP SP		● ●
	95,10	6,70	7,80	95 AU V142	PU 83	40422492 24359847	IP SP		● ●
110	101,40	7,80	9	95 AU V142	PU 83	24380871	–		○
115	105,10	6,70	7,80	95 AU V142	PU 83	24355287 40422490	IP SP		● ●
	105,10	6,70	7,80	95 AU V142	PU 83	40422490 24355287	IP SP		● ●
120	110,60	7,90	9,10	95 AU V142	PU 83	530765	–		○
122	115,60	5,70	6,80	95 AU V142	PU 83	49001025	–		○
125	115,10	6,70	7,80	95 AU V142	PU 83	24355288 40422491	IP SP		● ●
	115,10	6,70	7,80	95 AU V142	PU 83	40422491 24355288	IP SP		● ●
	116,40	7,80	9	95 AU V142	PU 83	24379551	–		○
130	120,80	4,20	5	95 AU V142	PU 83	24311962	–		○
	121,40	7,80	9	95 AU V142	PU 83	528353	–		○
140	130,40	6,60	7,70	95 AU V142	PU 83	24362518	–		○
	131,40	7,80	9	95 AU V142	PU 83	49036033	–		○
	134,10	4,90	5,90	95 AU V142	PU 83	24245392 40422341	IP SP		● ●
	134,10	4,90	5,90	95 AU V142	PU 83	40422341 24245392	IP SP		● ●
145	135	7,30	8,40	95 AU V142	PU 83	24359031	–		○
150	140,40	6,60	7,70	95 AU V142	PU 83	24367348 40422496	IP SP		● ●
	140,40	6,60	7,70	95 AU V142	PU 83	40422496 24367348	IP SP		● ●
	141,90	8	9,20	95 AU V142	PU 83	24348854	–		○
160	151,40	7,80	9	95 AU V142	PU 83	49036034	–		○
165	159,20	4,90	5,90	95 AU V142	PU 83	24250883	–		○
180	170	7,30	8,40	95 AU V142	PU 83	24378895	–		○
	174,40	5,20	6,20	95 AU V142	PU 83	49001429	–		○
190	170	7,80	9	95 AU V142	PU 83	24361640	–		○
192	185,90	4,90	5,90	95 AU V142	PU 83	24250878	–		○
200	191,40	7,80	9	95 AU V142	PU 83	49004492	–		○
	193,90	4,90	5,90	95 AU V142	PU 83	24250880	–		○
210	201,40	7,80	9	94 AU 925	PU 83	49035972	–		○
225	216,40	7,80	9	95 AU V142	PU 83	531563	–		○
240	228,40	10,70	12,30	95 AU V142	PU 83	24375294	–		○
	231,40	7,80	9	95 AU V142	PU 83	24360083	–		○
242	236	4,90	5,90	95 AU V142	PU 83	24245390	–		○
250	241,40	7,80	9	95 AU V142	PU 83	49022154	–		○
265	253,40	10,70	12,30	95 AU V142	PU 83	49000175	–		○
270	261,40	7,70	9	94 AU 925	PU 83	49017087	–		○
280	268,40	10,90	12,30	95 AU V142	PU 83	49033375	–		○
288	282	4,90	5,90	95 AU V142	PU 83	24250877	–		○

D [mm]	d [mm]	H [mm]	L [mm]	Material	Design	Part No.	PU ¹⁾	US	EU
290	281,40	7,50	8,80	95 AU V142	PU 83	525514	-		○
300	290,30	8,10	9,30	95 AU V142	PU 83	49016225	-		○
310	298,40	10,70	12,30	94 AU 925	PU 83	49038888	-		○
320	308,40	10,40	12	95 AU V142	PU 83	529772	-		○
340	331,40	7,70	9	95 AU V142	PU 83	525487	-		○
350	338,40	10,70	12,30	94 AU 925	PU 83	49038889	IP		●
360	348,40	10,40	12	94 AU 925	PU 83	49004019	-		○
380	368,40	10,90	12,30	95 AU V142	PU 83	49033376	-		○
390	378,40	10,40	12	95 AU V142	PU 83	49002712	-		○
400	388,40	10,70	12,30	95 AU V142	PU 83	532306	-		○
410	398,40	10,70	12,30	95 AU V142	PU 83	49001342	-		○
420	408,40	10,70	12,30	95 AU V142	PU 83	24379139	-		○
430	418,40	10,90	12,30	94 AU 925	PU 83	49027155	-		○
440	428,40	10,90	12,30	94 AU 925	PU 83	49030619	IP		●
450	438,40	10,70	12,30	95 AU V142	PU 83	529212	-		○
460	448,40	10,90	12,30	94 AU 925	PU 83	49023288	-		○
470	458,40	10,70	12,30	94 AU 925	PU 83	49021561	-		○
480	463	14,40	16,30	94 AU 925	PU 83	49004706	-		○
	468,40	10,90	12,30	94 AU 925	PU 83	49025771	-		○
490	478,40	10,90	12,30	95 AU V142	PU 83	49033377	-		○
500	488,40	10,70	12,30	94 AU 925	PU 83	530849	-		○
520	508,40	10,60	12,20	95 AU V142	PU 83	532963	-		○
530	518,40	10,60	12,20	94 AU 925	PU 83	529838	IP		●
550	536,60	11,80	13,60	94 AU 925	PU 83	49000360	-		○
560	548,40	10,90	12,30	94 AU 925	PU 83	49027156	-		○
570	556,60	11,80	13,60	94 AU 925	PU 83	49007603	-		○
660	643	14,40	16,30	94 AU 925	PU 83	49012006	-		○
730	715	10,70	12,30	94 AU 925	PU 83	24360742	-		○
810	793	14,40	16,30	94 AU 925	PU 83	49015798	-		○
813	830	15,60	16,30	94 AU 925	PU 83	24361263	-		○
860	843	14,40	16,30	94 AU 925	PU 83	49015799	-		○
960	943	14,40	16,30	94 AU 925	PU 83	49012180	-		○

STATISCHE DICHTUNGEN AXIAL DICHTEND | EKSENEL ÇALIŞAN STATİK SIZDIRMAZLIK ELEMANLARI
 USZCZELNIENIA STATYCZNE USZCZELNIAJĄCE OSIOWO | СТАТИЧЕСКИЕ АКСИАЛЬНЫЕ УПЛОТНЕНИЯ

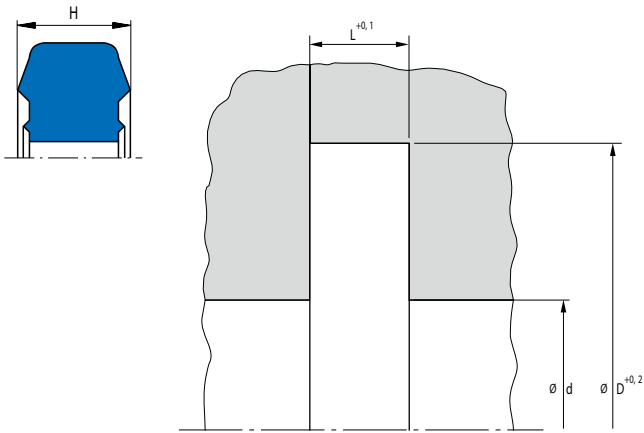



















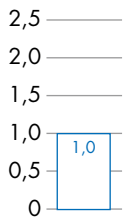
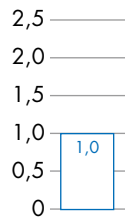
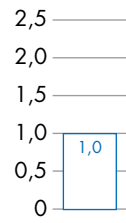
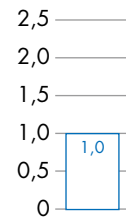
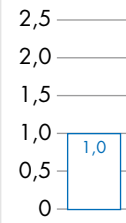
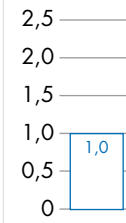
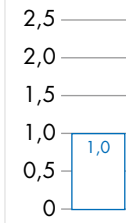
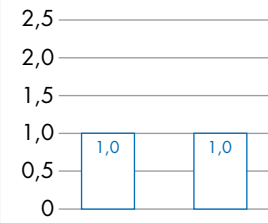

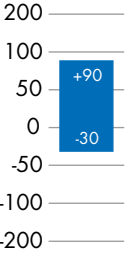
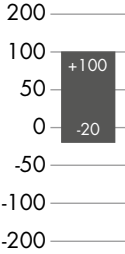
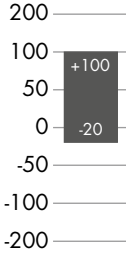
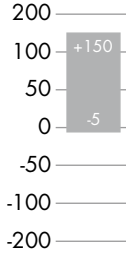
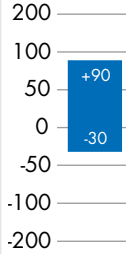
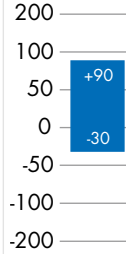
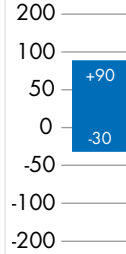
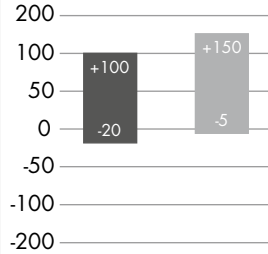
Wenn Sie Ihre Dichtung nicht finden können – Ihre Lösung auf Seite 12
 Aradığınız ürünü bulamadığınız takdirde – çözümünüz sayfa 12
 Jeżeli nie możecie Państwo znaleźć uszczelki – rozwiązanie znajduje się na stronie 12
 Вы не можете подобрать необходимое уплотнение? – Решение на странице 12

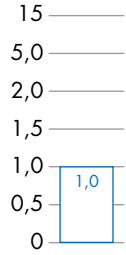
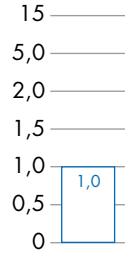
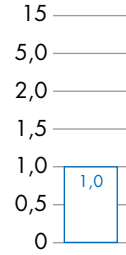
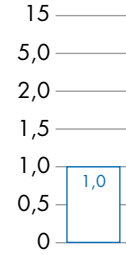
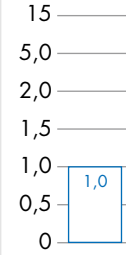
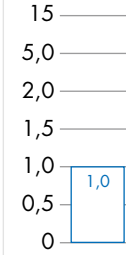
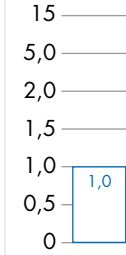
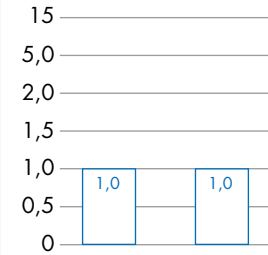
1) IP = Industriepackung | Endüstriyel ambalaj | Opakowania przemysłowe | Производственная тара
 SP = Einzelpackung | Tek bir Paketli | Pojedyncze opakowanie | Single Pack

● Auf Lager | Stoklarda mevcuttur | Dostępne w magazynie | Имеется в наличии на складе
 ○ Auf Anfrage | Talep üzerine | Na zapytanie | По запросу

d [mm]	D [mm]	H [mm]	L [mm]	Material	Design	Part No.	PU ¹⁾	US	EU
6	12	2,40	1,90	95 AU V142	SRC	24350847 40422478	IP SP		● ●
	12	2,40	1,90	95 AU V142	SRC	40422478 24350847	IP SP		● ●
8	14	2,40	1,90	95 AU V142	SRC	24350848 40422479	IP SP		● ●
	14	2,40	1,90	95 AU V142	SRC	40422479 24350848	IP SP		● ●
10	16	2,40	1,90	95 AU V142	SRC	24350849 40422480	IP SP		● ●
	16	2,40	1,90	95 AU V142	SRC	40422480 24350849	IP SP		● ●
12	18	2,40	1,90	95 AU V142	SRC	24350850 40422481	IP SP		● ●
	18	2,40	1,90	95 AU V142	SRC	40422481 24350850	IP SP		● ●
14	21	2,40	1,90	95 AU V142	SRC	24350851 40422482	IP SP		● ●
	21	2,40	1,90	95 AU V142	SRC	40422482 24350851	IP SP		● ●
16	23	2,40	1,90	95 AU V142	SRC	24350852 40422483	IP SP		● ●
	23	2,40	1,90	95 AU V142	SRC	40422483 24350852	IP SP		● ●
20	27	2,40	1,90	95 AU V142	SRC	24350853 40422484	IP SP		● ●
	27	2,40	1,90	95 AU V142	SRC	40422484 24350853	IP SP		● ●
24	30	2,40	1,90	95 AU V142	SRC	24354033 40422488	IP SP		● ●
	30	2,40	1,90	95 AU V142	SRC	40422488 24354033	IP SP		● ●
25	33	3	2,40	95 AU V142	SRC	24350855 40422485	IP SP		● ●
	33	3	2,40	95 AU V142	SRC	40422485 24350855	IP SP		● ●
30	38	2,40	1,90	95 AU V142	SRC	24337027 40422465	IP SP		● ●

d [mm]	D [mm]	H [mm]	L [mm]	Material	Design	Part No.	PU ¹⁾	US	EU
30	38	2,40	1,90	95 AU V142	SRC	40422465 24337027	IP SP		● ●
32	40	3	2,40	95 AU V142	SRC	24336213 40422464	IP SP		● ●
	40	3	2,40	95 AU V142	SRC	40422464 24336213	IP SP		● ●
40	48	3	2,40	95 AU V142	SRC	24343125 40422473	IP SP		● ●
	48	3	2,40	95 AU V142	SRC	40422473 24343125	IP SP		● ●
45	53	3	2,40	95 AU V142	SRC	49003451	-		○
50	58	3,10	2,50	95 AU V142	SRC	24350857 40422486	IP SP		● ●
	58	3,10	2,50	95 AU V142	SRC	40422486 24350857	IP SP		● ●
75	83	3,10	2,50	95 AU V142	SRC	24367176	-		○
90	100	3,80	3,20	95 AU V142	SRC	532063	-		○
102	110	3,10	2,50	95 AU V142	SRC	49031644	-		○
122	130	3,10	2,50	95 AU V142	SRC	49031645	-		○
132	140	3,10	2,50	95 AU V142	SRC	49031646	-		○
260	235,40	7,250	5,80	95 AU V142	SRC	49043603	-		○
320	295,40	7,250	5,80	95 AU V142	SRC	49017430	-		○
360	335,40	7,250	5,80	95 AU 925	SRC	49017431	-		○
370	345	7,10	5,60	94 AU 925	SRC	49026142	-		○
	349,40	7,250	5,80	94 AU 925	SRC	49031386	-		○
405	421	7,50	6	95 AU V142	SRC	532071	-		○
	430	7,10	5,60	94 AU 925	SRC	49015833	-		○
440	415,40	7,250	5,80	95 AU V142	SRC	49017432	-		○
460,40	485	7,30	5,80	95 AU V142	SRC	49016295	-		○
490	469,40	7,250	5,80	94 AU 925	SRC	49045102	-		○
540	512,80	8,350	6,70	94 AU 925	SRC	49017433	-		○
570	542,80	8,350	6,70	94 AU 925	SRC	49026033	-		○
615	587,80	8,350	6,70	94 AU 925	SRC	49017434	-		○
675	647,80	8,350	6,70	94 AU 925	SRC	49017435	-		○
750	725	8,950	7,20	94 AU 925	SRC	49017436	-		○
815	840	8,950	7,20	94 AU 925	SRC	49028615	-		○
820	795	8,950	7,20	94 AU 925	SRC	49032358	-		○
830	809,40	8,85	7,10	94 AU 925	SRC	49026599	-		○
975	955	9,30	7,50	94 AU 925	SRC	49062359	-		○
1020	995	8,950	7,20	94 AU 925	SRC	49031377	-		○
1040	1015	8,950	7,20	94 AU 925	SRC	49017437	-		○
1090	1065	8,950	7,20	94 AU 925	SRC	49045105	-		○
1140	1115	8,95	7,20	94 AU 925	SRC	49017438	-		○
1540	1523,20	7,10	5,60	94 AU 925	SRC	49040364	-		○
1585	1568,20	7,10	5,60	94 AU 925	SRC	49062554	-		○

Type	AU NIPSL	NIPSL	NIPSL 200	NIPSL 210	NIPSL 300	NIPSL 310	NIPSL 320	Airzet PR	
Standard	ISO	ISO	ISO	ISO	ISO	ISO	ISO	ISO	
Shape									
Compound	Polyurethane 94 AU 925	NBR 72 NBR 708	NBR 80 NBR 4005	FKM 75 FKM 181327	Polyurethane 85 AU 20991	Polyurethane 85 AU 20991	Polyurethane 94 AU 925	NBR 80 NBR 186349	FKM 75 FKM 230553
									
									
									
Applications									

Bitte beachten Sie unsere allgemeinen Konstruktionshinweise in → Technisches Handbuch

Daha detaylı montaj bilgisi için → Bkz. Technical Manual

W celu zaznajomienia się z ogólnymi uwagami proszę skorzystać z Instrukcji

Общие технические рекомендации см. → Техническое руководство

STANGENDICHTUNGEN | ROD SIZDIRMAZLIK ELEMANLARI USZCZELNIENIA TŁOKA | ШТОКОВЫЕ УПЛОТНЕНИЯ

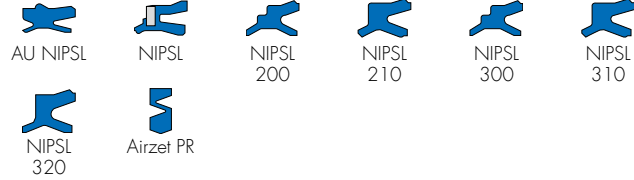
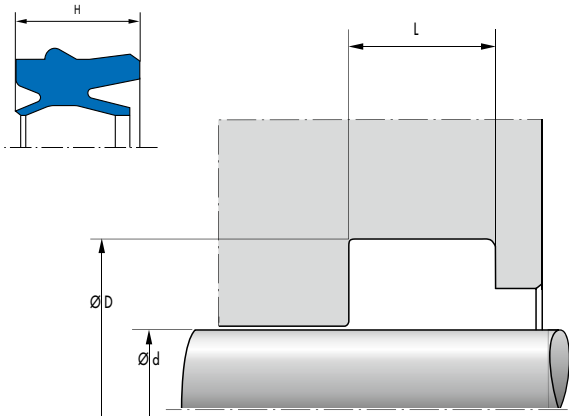

Wenn Sie Ihre Dichtung nicht finden können – Ihre Lösung auf Seite 12
Aradığınız ürünü bulamadığınız takdirde – çözümünüz sayfa 12
Jeżeli nie możecie Państwo znaleźć uszczelki – rozwiązanie znajduje się na stronie 12
Вы не можете подобрать необходимое уплотнение? – Решение на странице 12









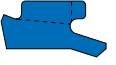
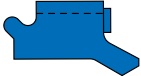

1) IP = Industriepackung | Endüstriyel ambalaj | Opakowania przemysłowe | Производственная тара
SP = Einzelpackung | Tek bir Paket | Pojedyncze opakowanie | Single Pack

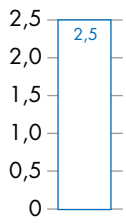
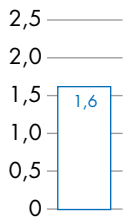
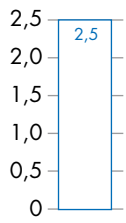
● Auf Lager | Stoklarda mevcuttur | Dostępne w magazynie | Имеется в наличии на складе
○ Auf Anfrage | Talep üzerine | Na zapytanie | По запросу

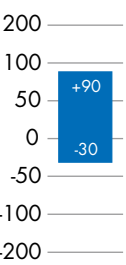
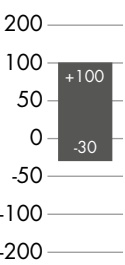
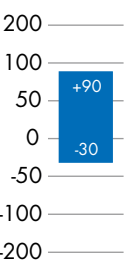
d [mm]	D [mm]	H [mm]	L [mm]	Material	Design	Part No.	PU ¹⁾	US	EU
4	7	2,8	2,6	75 FKM 181327	NIPSL 210	476707	IP		●
	7	2,8	2,6	85 AU 20991	NIPSL 310	476708	IP		●
	8,2	4,2	3	80 NBR 4005	NIPSL 200	472544	IP		●
	8,2	4,2	3	85 AU 20991	NIPSL 300	49062575	IP		●
6	9	2,8	2,6	75 FKM 181327	NIPSL 210	49022141	IP		●
	9	2,8	2,6	85 AU 20991	NIPSL 310	468066	IP		●
	11,2	5,2	3,6	80 NBR 4005	NIPSL 200	472545	IP		●
	11,2	5,2	3,6	85 AU 20991	NIPSL 300	49058497	IP		●
	13	2,3	2,5	80 NBR 186349	Airzet PR	49017399	IP		●
	13	2,3	2,5	75 FKM 230553	Airzet PR	49041787	–		○
8	11,5	3,2	2,9	75 FKM 181327	NIPSL 210	473868	IP		●
	11,5	3,2	2,9	85 AU 20991	NIPSL 310	468065	IP		●
	14,2	5,2	3,6	80 NBR 4005	NIPSL 200	472546	IP		●
	14,2	5,2	3,6	85 AU 20991	NIPSL 300	49058498	IP		●
	15	2,3	2,5	80 NBR 186349	Airzet PR	49017400	IP	○	●
	15	2,3	2,5	75 FKM 230553	Airzet PR	49042524	IP		●
10	14	3,7	3,2	75 FKM 181327	NIPSL 210	473869	IP	○	●
	14	3,7	3,2	85 AU 20991	NIPSL 310	468061	IP		●
	16	4,8	4	94 AU 925	NIPSL 320	433063	IP		●
	16,2	6,2	4,2	80 NBR 4005	NIPSL 200	472547	IP		●
	16,2	6,2	4,2	85 AU 20991	NIPSL 300	49058499	IP	○	●
	17	2,3	2,5	80 NBR 186349	Airzet PR	49017401	IP	○	●
	17	2,3	2,5	75 FKM 230553	Airzet PR	49042525	IP		●
	20	9,5	8,5	72 NBR 708	NIPSL	419273	IP	○	●
12	16,5	4	3,6	75 FKM 181327	NIPSL 210	471228	IP		●
	16,5	4	3,6	85 AU 20991	NIPSL 310	468060	IP	○	●
	18	4,8	4	94 AU 925	NIPSL 320	433064	IP		●
	18,1	6,2	4,2	85 AU 20991	NIPSL 300	49067732	IP		●
	18,2	6,2	4,2	80 NBR 4005	NIPSL 200	472548	IP		●
	19	2,3	2,5	80 NBR 186349	Airzet PR	49017996	IP		●

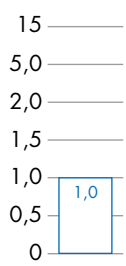
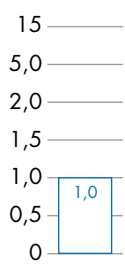
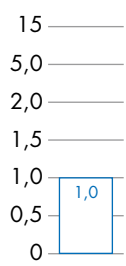
d [mm]	D [mm]	H [mm]	L [mm]	Material	Design	Part No.	PU ¹⁾	US	EU
12	19	2,3	2,5	75 FKM 230553	Airzet PR	49041788	IP	○	●
	20	8,5	7,5	72 NBR 708	NIPSL	419274	IP	○	●
	20	10,4	13	94 AU 925	AU NIPSL	431469	IP		●
	22	9,5	8,5	72 NBR 708	NIPSL	104779	IP		●
	22	10,4	13	94 AU 925	AU NIPSL	407284 40728485	IP -	○	●
14	22	10,4	13	94 AU 21200	AU NIPSL	49072208	IP		●
	24	9,5	8,5	72 NBR 708	NIPSL	419275	IP		●
14	24	10,4	13	94 AU 925	AU NIPSL	431468	-		○
	22	2,3	2,5	80 NBR 186349	Airzet PR	49017905	IP		●
15	22	2,3	2,5	75 FKM 230553	Airzet PR	49042526	IP		●
	20,5	4	3,6	75 FKM 181327	NIPSL 210	471885	IP		●
16	20,5	4	3,6	85 AU 20991	NIPSL 310	468120	IP		●
	22	4,8	4	94 AU 925	NIPSL 320	433065	IP	○	●
	23	6,2	4,2	80 NBR NB116	NIPSL 200	472549	IP		●
	23	6,2	4,2	85 AU 20991	NIPSL 300	49067733	IP		●
	25	2,8	3	80 NBR 186349	Airzet PR	49017904	IP	○	●
	25	2,8	3	75 FKM 230553	Airzet PR	49041789	IP		●
	26	9,5	8,5	72 NBR 708	NIPSL	104780	IP		●
	26	10,4	13	94 AU 925	AU NIPSL	407285 40728596	IP -	○	●
18	26	8,5	7,5	72 NBR 708	NIPSL	390006	IP	○	●
	26	10,4	13	94 AU 925	AU NIPSL	431467	-	○	○
	28	9,5	8,5	72 NBR 708	NIPSL	121453	IP		●
	28	10,4	13	94 AU 925	AU NIPSL	431465	-		○
20	25	4,6	4	75 FKM 181327	NIPSL 210	471375	IP		●
	25	4,6	4	85 AU 20991	NIPSL 310	470526	IP	○	●
	26	4,8	4	94 AU 925	NIPSL 320	433068	IP		●
	29	2,8	3	75 FKM 230553	Airzet PR	49030235	IP	○	●
	29	2,8	3	80 NBR 186349	Airzet PR	49017906	IP	○	●
	30	9,5	8,5	72 NBR 708	NIPSL	104781	IP	○	●
	30	10,4	13	94 AU 925	AU NIPSL	407287	IP	●	●
22	32	9,5	8,8	72 NBR 708	NIPSL	404837	IP		●
	32	10,4	13	94 AU 925	AU NIPSL	431464	-		○
25	30	4,6	4	75 FKM 181327	NIPSL 210	471734	IP		●
	30	4,6	4	85 AU 20991	NIPSL 310	471728	IP	○	●
	31	4,8	4	94 AU 925	NIPSL 320	468023	IP	○	●
	34	2,8	3	80 NBR 186349	Airzet PR	49030179	IP	○	●
	34	2,8	3	75 FKM 230553	Airzet PR	49042527	IP	○	●
	35	9,5	8,8	72 NBR 708	NIPSL	104782	IP		●
	35	10,4	13	94 AU 925	AU NIPSL	407288	IP	○	●
30	39	2,8	3	80 NBR 186349	Airzet PR	49030180	IP	○	●
	39	2,8	3	75 FKM 230553	Airzet PR	49041790	IP		●
	40	9,5	8,8	72 NBR 708	NIPSL	361502	IP		●
	40	10,4	13	94 AU 925	AU NIPSL	431462	IP	○	●
32	37,5	5	4,4	75 FKM 181327	NIPSL 210	475939	IP		●
	37,5	5	4,4	85 AU 20991	NIPSL 310	476906	IP	○	●
	40	5,8	5	94 AU 925	NIPSL 320	467972	IP		●
	42	9,5	8,8	72 NBR 708	NIPSL	419276	IP	○	●
	42	10,4	13	94 AU 925	AU NIPSL	407290 40729051	IP -	○	●

d [mm]	D [mm]	H [mm]	L [mm]	Material	Design	Part No.	PU ¹⁾	US	EU
40	49	2,8	3	80 NBR 186349	Airzet PR	49017968	IP		●
	49	2,8	3	75 FKM 230553	Airzet PR	49042528	IP		●
	50	9,5	8,8	72 NBR 708	NIPSL	419277	IP	○	●
	50	10,4	13	94 AU 925	AU NIPSL	398274 39827455	IP -	○	●
42	51	2,8	3	80 NBR 186349	Airzet PR	49030174	IP		●
	51	2,8	3	75 FKM 230553	Airzet PR	49042529	IP		●
50	59	2,8	3	80 NBR 186349	Airzet PR	49030181	IP		●
	59	2,8	3	75 FKM 230553	Airzet PR	49042530	IP		●
	60	9	8,3	72 NBR 708	NIPSL	433162	IP		●
	60	10,4	13	94 AU 925	AU NIPSL	49068469	IP		●
	60	10,4	13	94 AU 925	AU NIPSL	398275	-	○	○

Type	AU DIP	DIP	D+S 300	
Standard	ISO	ISO	ISO	
Shape				
Compound	Polyurethane 90 AU 924 94 AU 925	NBR 90 NBR 109	Polyurethane 85 AU 21030	
 MPa				
 Celsius				
 m/s				
Applications				

Bitte beachten Sie unsere allgemeinen Konstruktionshinweise in → Technisches Handbuch

Daha detaylı montaj bilgisi için → Bkz. Technical Manual

W celu zaznajomienia się z ogólnymi uwagami proszę skorzystać z Instrukcji

Общие технические рекомендации см. → Техническое руководство

DÄMPFUNGSICHTUNGEN | DAMPER KEÇELER TŁUMIKI | ДЕМПФЕРНЫЕ УПЛОТНЕНИЯ

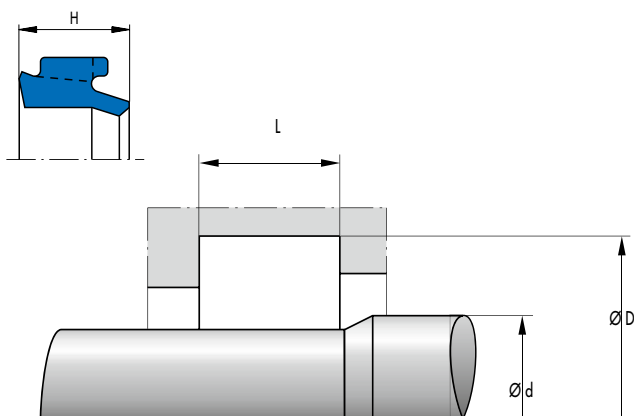















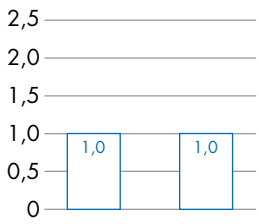
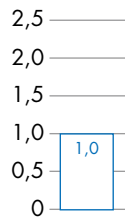
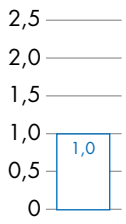
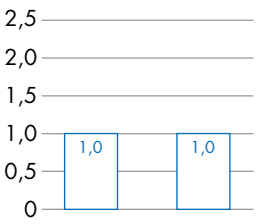
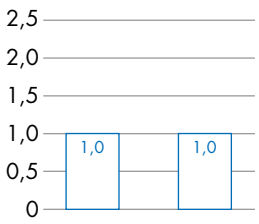

Wenn Sie Ihre Dichtung nicht finden können – Ihre Lösung auf Seite 12
Aradığınız ürünü bulamadığınız takdirde – çözümünüz sayfa 12
Jeżeli nie możecie Państwo znaleźć uszczelki – rozwiązanie znajduje się na stronie 12
Вы не можете подобрать необходимое уплотнение? – Решение на странице 12

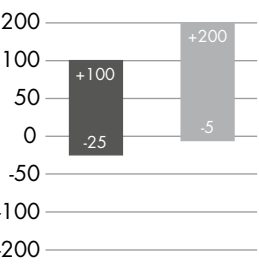
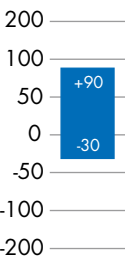
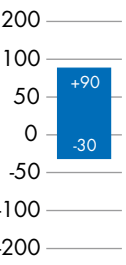
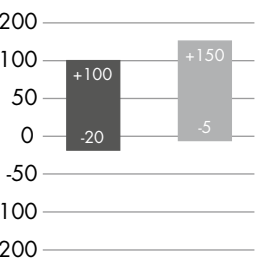
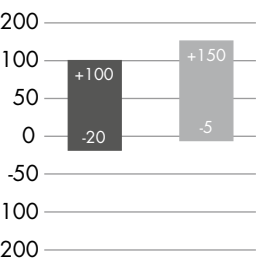
1) IP = Industriepackung | Endüstriyel ambalaj | Opakowania przemysłowe | Производственная тара
SP = Einzelpackung | Tek bir Paket | Pojedyncze opakowanie | Single Pack

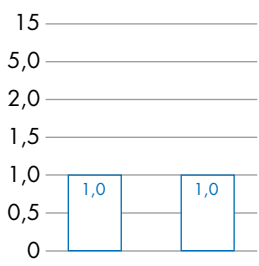
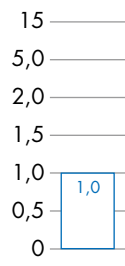
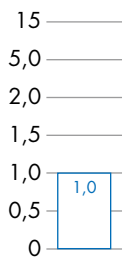
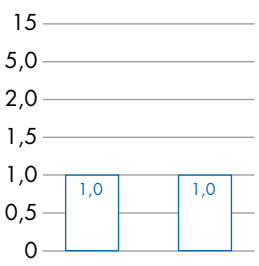
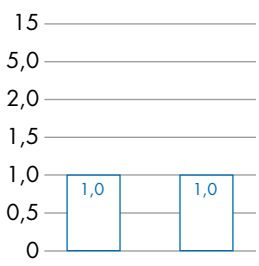















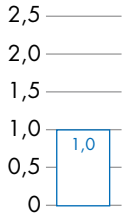
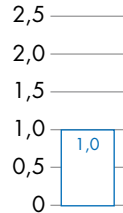
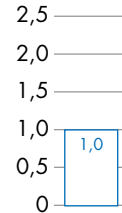
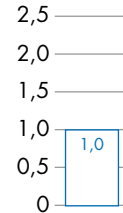
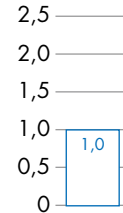
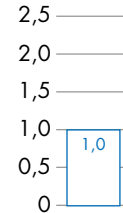
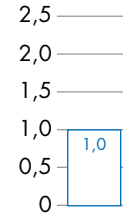
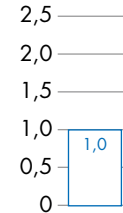
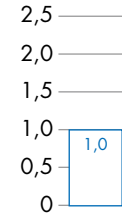
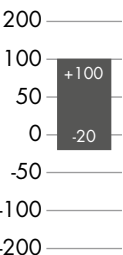
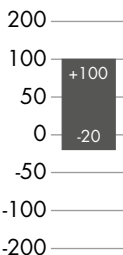
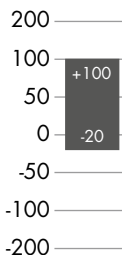
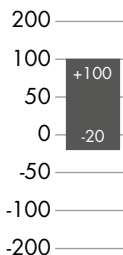
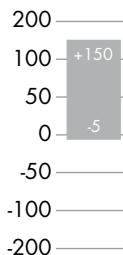
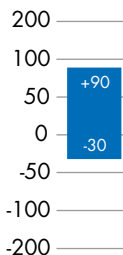
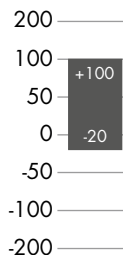
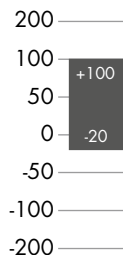
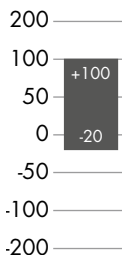
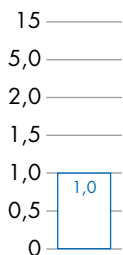
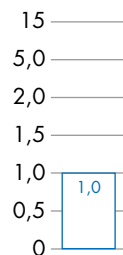
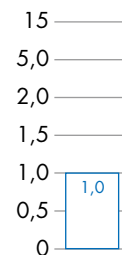
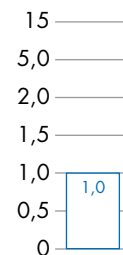
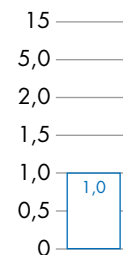
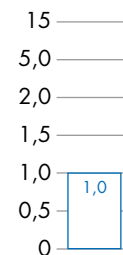
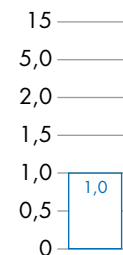
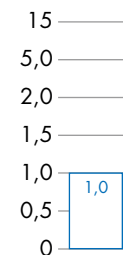
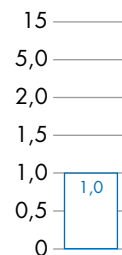

● Auf Lager | Stoklarda mevcuttur | Dostępne w magazynie | Имеется в наличии на складе
○ Auf Anfrage | Talep üzerine | Na zapytanie | По запросу

d [mm]	D [mm]	H [mm]	L [mm]	Material	Design	Part No.	PU ¹⁾	US	EU
7	16	5,3	3,9	85 AU 21030	D+S 300	49320286	IP		●
8	11,6	3,5	3,3	85 AU 20991	AU DIP	49066296	IP		●
9,5	15	5	4,5	85 AU 20991	AU DIP	434735	IP		●
10	18	8	7	85 AU 20991	AU DIP	425536	IP		●
12	20	8	7	85 AU 20991	AU DIP	425497	–		○
	25	6,5	4,9	85 AU 21030	D+S 300	49082387	IP		●
14	22	6,5	8	90 NBR 109	DIP	406509	IP		●
	22	8	7	94 AU 925	AU DIP	425538	IP	○	●
	32	6,5	4,9	85 AU 21030	D+S 300	49072518	IP		●
16	22	5,6	5,2	94 AU 925	AU DIP	425499 42549984	IP –	○	●
	24	6,5	8	90 NBR 109	DIP	408706	IP		●
	24	8	7	94 AU 925	AU DIP	425498	IP		●
	32	6,5	4,9	85 AU 21030	D+S 300	49072519	IP		●
18	26	8	7	94 AU 925	AU DIP	425509	IP	○	●
	28	6,5	8	90 NBR 109	DIP	408714	IP		●
20	28	8	7	94 AU 925	AU DIP	464942	IP	○	●
	40	6,8	4,9	85 AU 21030	D+S 300	49081094	IP		●
22	30	6,5	8	90 NBR 109	DIP	408747	IP		●
	30	8	7	94 AU 925	AU DIP	425511	IP	○	●
24	32	8	7	94 AU 925	AU DIP	425513	IP	○	●
	33	6,5	8	90 NBR 109	DIP	408750	IP	○	●
	33	8	7	94 AU 925	AU DIP	425514 42551462	IP –	○	●
25	50	6,8	4,9	85 AU 21030	D+S 300	49081095	IP		●
	63	7,3	4,9	85 AU 21030	D+S 300	49081096	IP		●
28	36	6,5	8	90 NBR 108	DIP	408753	IP		●
	36	8	7	94 AU 925	AU DIP	425515	IP	○	●
30	40	6,5	8	90 NBR 109	DIP	408756	IP		●
	40	8	7	94 AU 925	AU DIP	425520 42552038	IP –	○	●

d [mm]	D [mm]	H [mm]	L [mm]	Material	Design	Part No.	PU ¹⁾	US	EU
30	80	7,7	4,9	85 AU 21030	D+S 300	49081097	-		○
	100	7,7	4,9	85 AU 21030	D+S 300	49313772	-		○
34	43	6,5	8	NBR 146094	DIP	12014754	-		○
36	46	8	7	94 AU 925	AU DIP	432656	IP	○	●
						43265644			
40	50	6,5	8	90 NBR 109	DIP	408759	IP	○	●
	50	8	7	94 AU 925	AU DIP	425521			
50	60	6,5	8	90 NBR 109	DIP	408761	IP		●
	60	8	7	94 AU 925	AU DIP	425523 42552361			

Type	NAP 210		NAP 300	NAP 310	NAPN		Airzet PK	
Standard	ISO		ISO	ISO	ISO		ISO	
Shape								
Compound	NBR 80 NBR 99079	FKM 75 FKM 99104	Polyurethane 80 AU 941	Polyurethane 80 AU 20994	NBR 80 NBR 186349	FKM 75 FKM 230553	NBR 80 NBR 186349	FKM 75 FKM 230553
								
								
								
Applications								

Bitte beachten Sie unsere allgemeinen Konstruktionshinweise in → Technisches Handbuch
 Daha detaylı montaj bilgisi için → Bkz. Technical Manual
 W celu zaznajomienia się z ogólnymi uwagami proszę skorzystać z Instrukcji
 Общие технические рекомендации см. → Техническое руководство

TR 200	KDN	NADUOP	Pneuko G	Pneuko M 210	Pneuko M 310	TDUOP	TDUOP AIR	TDUOP M
ISO	ISO	ISO	ISO	ISO	ISO	ISO	ISO	ISO
								
NBR 72 NBR 708	NBR 72 NBR 708	NBR 72 NBR 708	NBR/PA 72 NBR 708 PA4601	FKM 75 FKM 181327	Polyurethane 80 AU 21000	NBR 72 NBR 708	NBR 72 NBR 708	NBR 72 NBR 708
								
								
								
								

KOLBENDICHTUNGEN | PISTON SIZDIRMAZLIK ELEMANLARI USZCZELNIENIA TŁOCZYSKA | ПОРШНЕВЫЕ УПЛОТНЕНИЯ

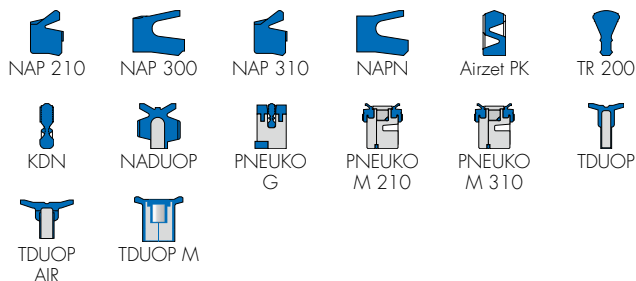
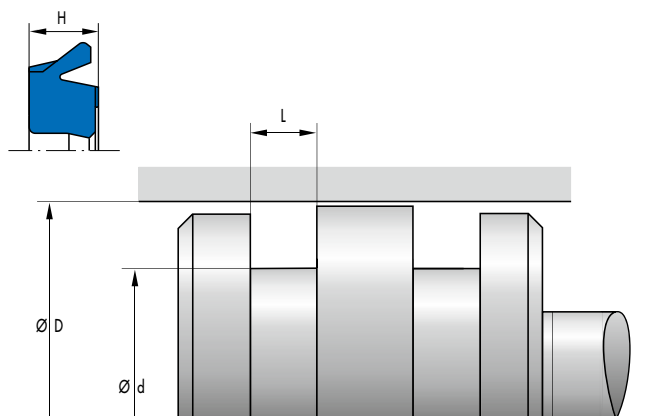

Wenn Sie Ihre Dichtung nicht finden können – Ihre Lösung auf Seite 12
 Aradığınız ürünü bulamadığınız takdirde – çözümünüz sayfa 12
 Jeżeli nie możecie Państwo znaleźć uszczelki – rozwiązanie znajduje się na stronie 12
 Вы не можете подобрать необходимое уплотнение? – Решение на странице 12

1) IP = Industriepackung | Endüstriyel ambalaj | Opakowania przemysłowe | Производственная тара
 SP = Einzelpackung | Tek bir Paket | Pojedyncze opakowanie | Single Pack

● Auf Lager | Stoklarda mevcuttur | Dostępne w magazynie | Имеется в наличии на складе
 ○ Auf Anfrage | Talep üzerine | Na zapytanie | По запросу









D [mm]	d [mm]	H [mm]	L [mm]	Material	Design	Part No.	PU ¹⁾	US	EU
6	2	3,5	4	80 NBR 186349	NAPN	49024487	IP		●
	3	4,2	1,8	72 NBR 708	NADUOP	407194	IP		●
	4,8	2,45	2,7	80 NBR 99079	NAP 210	463761	IP		●
	4,8	2,45	2,7	75 FKM 99104	NAP 210	465838	IP		●
	4,8	2,45	2,7	80 AU 20994	NAP 310	433197	IP		●
	4,8	2,45	2,7	80 AU 20994	NAP 310	49042868	IP		●
	4,8	3	3,5	80 NBR 186349	NAPN	49012343	IP		●
10	3	4,2	1,8	72 NBR 708	NADUOP	407199	IP		●
	5	3	3,5	80 NBR 186349	NAPN	49024489	IP	○	●
	6	2,45	2,7	80 NBR 99079	NAP 210	463763	IP		●
	6	2,45	2,7	75 FKM 99104	NAP 210	465839	IP		●
	6	2,45	2,7	80 AU 20994	NAP 310	433199	IP		●
12	6	2,45	2,7	80 AU 20994	NAP 310	49056721	IP		●
	3	6	4	72 NBR 708	PKG	430709	IP		●
	4,5	5,2	2,3	72 NBR 708	NADUOP	407203	IP		●
	5,1	1,8	1,8	72 NBR 708	KDN	49046430	IP		●
	7	2,2	2,5	80 NBR 186349	Airzet PK	49017990	IP		●
	7	2,2	2,5	75 FKM 230553	Airzet PK	49042426	IP		●
	7	2,45	2,7	80 NBR 99079	NAP 210	463764	IP	○	●
	7	2,45	2,7	75 FKM 99104	NAP 210	465841	IP		●
	7	2,45	2,7	80 AU 20994	NAP 310	433200	IP	○	●
	7	2,45	2,7	80 AU 20994	NAP 310	49056813	IP		●
16	7	4	4,5	80 NBR 186349	NAPN	49024486	IP		●
	4	6	4	72 NBR 708	PKG	428576	IP		●
	4,5	5,7	2,3	72 NBR 708	NADUOP	407205	IP	○	●
	8,9	2,1	2,1	72 NBR 708	KDN	49044391	IP		●
	9	2,4	2,5	80 NBR 186349	Airzet PK	49017991	IP		●
	9	2,4	2,5	75 FKM 230553	Airzet PK	49030236	IP		●
	10	2,45	2,7	80 NBR 99079	NAP 210	463765	IP		●
	10	2,45	2,7	75 FKM 99104	NAP 210	465842	IP		●

D [mm]	d [mm]	H [mm]	L [mm]	Material	Design	Part No.	PU ¹⁾	US	EU
16	10	2,45	2,7	80 AU 20994	NAP 310	49058788	IP	○	●
	10	4,5	5	80 NBR 186349	NAPN	49024490	IP		●
18	12	2,45	2,7	75 FKM 99104	NAP 210	501192	IP		●
	12	2,45	2,7	80 NBR 99079	NAP 210	501500	IP		●
20	6	6	4	72 NBR 708	PKG	430708	IP		●
	6	6,7	2,8	72 NBR 708	NADUOP	407207	IP		●
	11,6	2,2	2,4	72 NBR 708	TR200	49308243	-		○
	12,9	2,1	2,1	72 NBR 708	KDN	49046431	IP		●
	13	2,4	2,5	80 NBR 186349	Airzet PK	49017992	IP	○	●
	13	2,4	2,5	75 FKM 230553	Airzet PK	49041727	IP		●
	14	2,45	2,7	80 NBR 99079	NAP 210	463766	IP		●
	14	2,45	2,7	75 FKM 99104	NAP 210	465843	IP	○	●
	14	2,45	2,7	80 AU 20994	NAP 310	49058787	IP	○	●
25	6	6	4	72 NBR 708	PKG	428564	IP		●
	7	8	3,3	72 NBR 708	NADUOP	407209	IP	○	●
	8	12	3,8	72 NBR 708	TDUOP	112175	IP	○	●
	8	12	4	72 NBR 708	TDUOP AIR	406238	IP		●
	16,6	2,2	2,4	80 NBR 708	TR200	49306114	-		○
	17	5	5,5	80 NBR 186349	NAPN	49024491	IP		●
	17	5,5	6	80 AU 941	NAP 300	432441	IP		●
	17,9	2,1	2,1	72 NBR 708	KDN	429068	IP		●
	18	2,4	2,5	80 NBR 186349	Airzet PK	49017969 523076	IP -	○	●
	18	2,4	2,5	75 FKM 230553	Airzet PK	49041728 524981	IP -	○	●
	19	3,3	3,5	80 NBR 99079	NAP 210	463767	IP		●
	19	3,3	3,5	75 FKM 99104	NAP 210	465844	IP		●
	19	3,3	3,5	80 AU 20994	NAP 310	458854	IP		●
19	4	4,2	80 AU 20994	NAP 310	415663	-		○	
30	8	8	6,5	72 NBR 708	PKG	428565	IP		●
	17,9	2,1	2,1	72 NBR 708	KDN	429070	IP		●
	21	2,9	3	80 NBR 186349	Airzet PK	49017970	IP		●
	21	2,9	3	75 FKM 230553	Airzet PK	49041729	IP		●
32	8	8	4,5	72 NBR 708	NADUOP	451057	IP		●
	8	8	6,5	72 NBR 708	PKG	428566	IP		●
	8	15	3,8	72 NBR 708	TDUOP	112176	IP	○	●
	8	15	4	72 NBR 708	TDUOP AIR	406239	IP	○	●
	8	18	10	72 NBR 708	TDUOP M	436297	IP		●
	8,1	10,6	14	75 FKM 181327	PK M210	527394	IP		●
	8,1	10,6	14	85 AU 21030	PK M310	525994	IP		●
	19,9	2,1	2,1	72 NBR 708	KDN	502039	IP		●
	21,6	2,8	3	72 NBR 708	TR200	49306115	-		○
	23	2,9	3	80 NBR 186349	Airzet PK	49017971	IP		●
	23	2,9	3	75 FKM 230553	Airzet PK	49030262	IP		●
	24	3,3	3,5	80 NBR 99079	NAP 210	463768	IP	○	●
	24	3,3	3,5	75 FKM 99104	NAP 210	465846	IP		●
	24	3,3	3,5	80 AU 20994	NAP 310	433205	IP	○	●
	24	5,5	6	80 AU 941	NAP 300	433688	IP	○	●
	24	5,5	6	80 AU 941	NAP 300	49308102	IP		●
24	5,5	6	80 NBR 186349	NAPN	49022834	IP	○	●	
24	5,5	6	75 FKM 230553	NAPN	49041663	IP		●	

D [mm]	d [mm]	H [mm]	L [mm]	Material	Design	Part No.	PU ¹⁾	US	EU
35	8	8	6,5	72 NBR 708	PKG	430711	IP		●
	8	15	4,8	72 NBR 708	TDUOP	125373	IP		●
	22,9	2,1	2,1	72 NBR 708	KDN	49046472	IP		●
	26	2,9	3	80 NBR 186349	Airzet PK	49030175	IP	○	●
	26	2,9	3	75 FKM 230553	Airzet PK	49042427	-		○
40	8,1	11,6	15	75 FKM 181327	PK M210	526800	IP		●
	8,1	11,6	15	80 AU 21000	PK M310	523464	IP		●
	10	8	6,5	72 NBR 708	PKG	428567	IP		●
	10	8,5	4,5	72 NBR 708	NADUOP	451142	IP		●
	10	18	4,8	72 NBR 708	TDUOP	112177	IP	○	●
	10	18	5	72 NBR 708	TDUOP AIR	406241	IP	○	●
	10	22	10	72 NBR 708	TDUOP M	420487	IP		●
	27,9	2,1	2,1	72 NBR 708	KDN	532581	IP		●
	29,6	2,8	3	72 NBR 708	TR200	49308244	-		○
	30	7	7,5	80 AU 941	NAP 300	49058588	IP		●
	30	7	7,5	80 NBR 186349	NAPN	49022833	IP		●
	30	7	7,5	75 FKM 230553	NAPN	49041664	IP		●
	31	2,9	3	80 NBR 186349	Airzet PK	49017982 523080	IP -	○	●
	31	2,9	3	75 FKM 230553	Airzet PK	49030238	IP		●
	32	3,3	3,5	80 NBR 99079	NAP 210	463769	IP	○	●
	32	3,3	3,5	75 FKM 99104	NAP 210	465847	IP		●
32	3,3	3,5	80 AU 20994	NAP 310	49041162 433209	IP -	○	●	
42	32	8,5	9	80 NBR 186349	NAPN	49024484	IP		●
	35	2,4	2,5	80 NBR 186349	Airzet PK	49017989	IP		●
	35	2,4	2,5	75 FKM 230553	Airzet PK	49042428	IP		●
45	36	2,8	3	80 NBR 186349	Airzet PK	49017983	IP		●
	36	2,8	3	75 FKM 230553	Airzet PK	49042429	IP		●
50	10	8	6,5	72 NBR 708	PKG	430710	IP		●
	10	8,5	4,5	72 NBR 708	NADUOP	451144	IP	○	●
	10	18	4,8	72 NBR 708	TDUOP	112178	IP		●
	10	18	5	72 NBR 708	TDUOP AIR	406245	IP		●
	10	20	8	72 NBR 708	TDUOP M	420488	IP	○	●
	10,1	12,1	15,5	75 FKM 181327	PK M210	526824	IP		●
	10,1	12,1	15,5	80 AU 21000	PK M310	523546	IP		●
	37,9	2,1	2,1	72 NBR 708	KDN	429083	IP	○	●
	39,6	2,8	3	72 NBR 708	TR200	49308245	-		○
	40	7	7,5	80 AU 941	NAP 300	49055977	IP		●
	40	7	7,5	80 NBR 186349	NAPN	49022832	IP		●
	40	7	7,5	75 FKM 230553	NAPN	49041665	IP		●
	41	2,9	3	80 NBR 186349	Airzet PK	49017984 523082	IP -	○	●
	41	2,9	3	75 FKM 230553	Airzet PK	49030241	IP	○	●
	42	3,3	3,5	80 NBR 99079	NAP 210	463770	IP	○	●
	42	3,3	3,5	75 FKM 99104	NAP 210	465848	IP		●
42	3,3	3,5	80 AU 20994	NAP 310	49041163 43321000	IP -	○	●	
60	12	8	6,5	72 NBR 708	PKG	430702	IP		●
	48	2,1	2,1	72 NBR 708	KDN	430632	IP		●
	48	3,9	4	80 NBR 186349	Airzet PK	49017985	IP		●
	48	3,9	4	75 FKM 230553	Airzet PK	49030239	IP		●

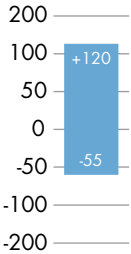
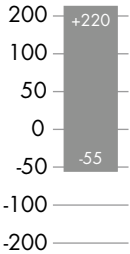
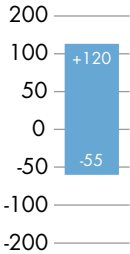
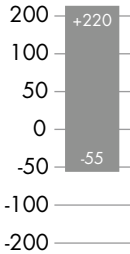
D [mm]	d [mm]	H [mm]	L [mm]	Material	Design	Part No.	PU ¹⁾	US	EU
63	10,1	15,79	19	75 FKM 181327	PK M210	527506	IP		●
	10,1	15,79	19	80 AU 21000	PK M310	525337	IP		●
	12	8	6,5	72 NBR 708	PKG	428569	IP		●
	12	22	5,8	72 NBR 708	TDUOP	112179	IP		●
	14	22	6	72 NBR 708	TDUOP AIR	406246	IP		●
	16	9,5	5,5	72 NBR 708	NADUOP	451146	IP		●
	16	22	6	72 NBR 708	TDUOP AIR	406248	IP		●
	16	25	10	72 NBR 708	TDUOP M	420489	IP	○	●
	50	3,6	3,8	72 NBR 708	TR200	49308246	-		○
	51	2,1	2,1	72 NBR 708	KDN	527489	IP		●
	51	3,9	4	80 NBR 186349	Airzet PK	49017986	IP	○	●
	51	3,9	4	75 FKM 230553	Airzet PK	49030240	IP		●
	53	4,3	4,5	80 NBR 99079	NAP 210	463771	IP		●
	53	4,3	4,5	75 FKM 99104	NAP 210	465849	IP		●
	53	4,3	4,5	80 AU 20994	NAP 310	49055498 43321222	IP -	○	●
	53	7	7,5	80 AU 941	NAP 300	406408	IP		●
	53	7	7,5	80 NBR 186349	NAPN	49018551	IP	○	●
	53	7	7,5	75 FKM 230553	NAPN	49041666	IP		●
70	12	8	6,5	72 NBR 708	PKG	430707	IP		●
	12	22	5,8	72 NBR 708	TDUOP	112180	IP		●
	58	2,1	2,1	72 NBR 708	KDN	430634	IP		●
	58	3,9	4	80 NBR 186349	Airzet PK	49030177	IP		●
	58	3,9	4	75 FKM 230553	Airzet PK	49042430	IP		●
80	12	10	8,5	72 NBR 708	PKG	428568	IP		●
	12,1	17,5	21,5	75 FKM 181327	PK M210	527767	IP		●
	12,1	17,5	21,5	80 AU 21000	PK M310	526210	IP		●
	14	25	6	72 NBR 708	TDUOP AIR	406250	IP		●
	16	9,5	5,5	72 NBR 708	NADUOP	451147	IP		●
	16	25	5,8	72 NBR 708	TDUOP	112239	IP		●
	16	25	6	72 NBR 708	TDUOP AIR	406266	IP		●
	16	27	10	72 NBR 708	TDUOP M	420491	IP		●
	20	27	10	72 NBR 708	TDUOP M	438285	IP		●
	67	3,6	3,8	72 NBR 708	TR200	49306118	-		○
	68	2,1	2,1	72 NBR 708	KDN	429086	IP		●
	68	3,9	4	80 NBR 186349	Airzet PK	49017987	IP	○	●
	68	3,9	4	75 FKM 230553	Airzet PK	49030263	IP	○	●
	68	8,4	9,4	80 NBR 186349	NAPN	49022821	IP		●
	68	8,4	9,4	75 FKM 230553	NAPN	49041667	IP	○	●
	68	8,5	9,5	80 AU 941	NAP 300	406412	IP	○	●
	70	4,3	4,5	80 NBR 99079	NAP 210	463772	IP		●
	70	4,3	4,5	75 FKM 99104	NAP 210	465850	IP		●
70	4,3	4,5	80 AU 20994	NAP 310	49055909	IP	○	●	
90	12	10	8,5	72 NBR 708	PKG	430712	IP		●
	12	24	7	72 NBR 708	TDUOP AIR	406275	IP		●
	78	3,9	4	75 FKM 230553	Airzet PK	49041730	IP		●
	78,1	2,1	2,1	72 NBR 708	KDN	429527	IP		●
100	12	10	8,5	72 NBR 708	PKG	428571	IP		●
	16	12,5	8,5	72 NBR 708	NADUOP	451148	IP		●
	16	25	6,8	72 NBR 708	TDUOP	112181	IP		●

D [mm]	d [mm]	H [mm]	L [mm]	Material	Design	Part No.	PU ¹⁾	US	EU
100	17,1	20	25,5	75 FKM 181327	PK M210	527866	IP		●
	17,1	20	25,5	80 AU 21000	PK M310	526499	IP		●
	18	25	9	72 NBR 708	TDUOP AIR	406277	IP	○	●
	20	25	9	72 NBR 708	TDUOP AIR	406279	IP	○	●
	20	27	10	72 NBR 708	TDUOP M	420494	IP		●
	87	3,6	3,8	72 NBR 708	TR200	49308247	-		○
	88	3,9	4	80 NBR 186349	Airzet PK	49017988 523087	IP -	○	●
	88	3,9	4	75 FKM 230553	Airzet PK	49042431	IP		●
	88	8,4	9,4	80 NBR 186349	NAPN	49022820	IP		●
	88	8,4	9,4	75 FKM 230553	NAPN	49041668	IP		●
	88	8,5	9,5	80 AU 941	NAP 300	49069189	IP		●
	88,1	2,1	2,1	72 NBR 708	KDN	429088	IP		●
	90	4,3	4,5	80 NBR 99079	NAP 210	463773	IP	○	●
	90	4,3	4,5	75 FKM 99104	NAP 210	465851	IP		●
	90	4,3	4,5	80 AU 20994	NAP 310	49063343	IP		●
125	18	30	9	72 NBR 708	TDUOP AIR	406280	IP		●
	20	12	9,5	72 NBR 708	PKG	428572	IP		●
	20	30	9,6	72 NBR 708	TDUOP	112182	IP	○	●
	105	8,1	8,5	80 AU 20994	NAP 310	422004	IP		●
	108,6	4,55	4,8	72 NBR 708	TR200	49306119	-		○
	110	4,9	5	80 NBR 186349	Airzet PK	49017993	IP	○	●
	110	4,9	5	75 FKM 230553	Airzet PK	49041731	IP		●
	110	10	11	80 AU 941	NAP 300	406415	IP	●	●
	110	10	11	80 NBR 186349	NAPN	49022819	IP		●
	110	10	11	75 FKM 230553	NAPN	49041669	-		○
113,3	2,1	2,1	72 NBR 708	KDN	429090	IP		●	
140	20	30	10,8	72 NBR 708	TDUOP	112183	IP		●
	125	4,7	5	80 NBR 186349	Airzet PK	524975	-		○
160	24	30	11	72 NBR 708	TDUOP AIR	406282	IP		●
	140	8,1	8,5	80 AU 20994	NAP 310	438908 43890848	IP -	○	●
	145	4,7	5	80 NBR 186349	Airzet PK	525027	-		○
	145	10	11	80 NBR 709	NAPN	434788	IP		●
200	24	30	11	72 NBR 708	TDUOP AIR	406288	IP	○	●
	180	8,1	8,5	80 AU 20994	NAP 310	438913 43891303	IP -	○	●
	180	14,4	15	80 NBR 709	NAPN	522405	IP		●
250	225	18	19	80 NBR 709	NAPN	434802	IP		●
	230	14	15	80 NBR 709	NAPN	460914	IP		●
320	295	18	19	80 NBR 709	NAPN	434804	IP		●

Type	BRN 3	BRT 3	BRN 2	BRT 2	
Standard	JIS	JIS	JIS	JIS	
Shape					
Compound	POM 80NP	PTFE 19YF	POM 80NP	PTFE 19YF	
					
Applications					

Bitte beachten Sie unsere allgemeinen Konstruktionshinweise in → Technisches Handbuch
 Daha detaylı montaj bilgisi için → Bkz. Technical Manual
 W celu zaznajomienia się z ogólnymi uwagami proszę skorzystać z Instrukcji
 Общие технические рекомендации см. → Техническое руководство

STÜTZRING ENDLOS | DÜZ DESTEK HALKASI PIERŚCIEŃ PODPOROWY | НЕРАЗРЕЗНЫЕ ОПОРНЫЕ КОЛЬЦА

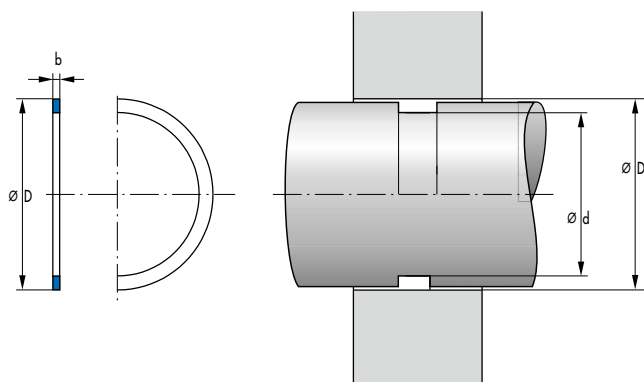

Wenn Sie Ihre Dichtung nicht finden können – Ihre Lösung auf Seite 12
Aradığınız ürünü bulamadığınız takdirde – çözümünüz sayfa 12
Jeżeli nie możecie Państwo znaleźć uszczelki – rozwiązanie znajduje się na stronie 12
Вы не можете подобрать необходимое уплотнение? – Решение на странице 12

1) IP = Industriepackung | Endüstriyel ambalaj | Opakowania przemysłowe | Производственная тара
SP = Einzelpackung | Tek bir Paket | Pojedyncze opakowanie | Single Pack

● Auf Lager | Stoklarda mevcuttur | Dostępne w magazynie | Имеется в наличии на складе
○ Auf Anfrage | Talep üzerine | Na zapytanie | По запросу

d [mm]	D [mm]	H [mm]	L [mm]	Material	Design	Part No.	PU ¹⁾	US	EU
3	6	1,25		PTFE 19YF	BRT3	GN0711-A0	–	○	
4	7	1,25		PTFE 19YF	BRT3	GN0714-A0	–	○	
5	8	1,25		PTFE 19YF	BRT3	GN0716-A0	–	○	
6	9	1,25		PTFE 19YF	BRT3	GN0719-A0	–	○	
6,3	14,3	2		PA 80NP	BRN3	GN9822-O0	–	○	
	14,3	2		PTFE 19YF	BRT3	GN7259-V0	–	○	
	16,3	2		PA 80NP	BRN3	GN9823-O0	–	○	
	16,3	2		PTFE 19YF	BRT3	GN0720-V0	–	○	
7	10	1,25		PTFE 19YF	BRT3	GN0722-A0	–	○	
7,1	17,1	2		PA 80NP	BRN3	GN9868-O0	–	○	
	17,1	2		PTFE 19YF	BRT3	GN0723-V0	–	○	
8	11	1,25		PTFE 19YF	BRT3	GN0724-A0	–	○	
	16	2		PA 80NP	BRN3	GN9824-O0	–	○	
	16	2		PTFE 19YF	BRT3	GN7260-V0	–	○	
	18	2		PA 80NP	BRN3	GN9101-O1	–	○	
9	18	2		PTFE 19YF	BRT3	GN0725-V0	–	○	
	12	1,25		PTFE 19YF	BRT3	GN0727-A0	–	○	
	17	2		PA 80NP	BRN3	GN9825-O0	–	○	
	17	2		PTFE 19YF	BRT3	GN7261-V0	–	○	
	19	2		PA 80NP	BRN3	GN9826-O0	–	○	
10	19	2		PTFE 19YF	BRT3	GN0728-V0	–	○	
	13	1,25		PTFE 19YF	BRT3	GN0731-A0	–	○	
	14	1,25		PTFE 19YF	BRT3	GN0732-A0	–	○	
	18	2		PA 80NP	BRN3	GN9827-O0	–	○	
	18	2		PTFE 19YF	BRT3	GN7262-V0	–	○	
	20	2		PA 80NP	BRN3	GN9102-O1	–	○	
11	20	2		PTFE 19YF	BRT3	GN0733-V0	–	○	
	15	1,25		PTFE 19YF	BRT3	GN0734-A0	–	○	
	15,2	1,25		PTFE 19YF	BRT3	GN0735-A0	–	○	
11,2	19,2	2		PA 80NP	BRN3	GN9792-O0	–	○	

d [mm]	D [mm]	H [mm]	L [mm]	Material	Design	Part No.	PU ¹⁾	US	EU
11,2	19,2	2		PTFE 19YF	BRT3	GN7236-V0	-	○	
	21,2	2		PA 80NP	BRN3	GN9828-O0	-	○	
	21,2	2		PTFE 19YF	BRT3	GN0736-V0	-	○	
12	16	1,25		PTFE 19YF	BRT3	GN0739-A0	-	○	
	20	2		PA 80NP	BRN3	GN9793-O0	-	○	
	20	2		PTFE 19YF	BRT3	GN7237-V0	-	○	
	25	2		PA 80NP	BRN3	GN9869-O0	-	○	
	25	2		PTFE 19YF	BRT3	GN6005-V0	-	○	
12,5	16,5	1,25		PTFE 19YF	BRT3	GN0740-A0	-	○	
	20,5	2		PA 80NP	BRN3	GN9829-O0	-	○	
	20,5	2		PTFE 19YF	BRT3	GN7263-V0	-	○	
	22,5	2		PA 80NP	BRN3	GN9830-O0	-	○	
	22,5	2		PTFE 19YF	BRT3	GN0741-V0	-	○	
14	18	1,25		PTFE 19YF	BRT3	GN0744-A0	-	○	
	22	2		PA 80NP	BRN3	GN9794-O0	-	○	
	22	2		PTFE 19YF	BRT3	GN7238-V0	-	○	
	24	2		PA 80NP	BRN3	GN9103-O1	-	○	
	24	2		PTFE 19YF	BRT3	GN0745-V0	-	○	
15	19	1,25		PTFE 19YF	BRT3	GN0748-A0	-	○	
	23	2		PA 80NP	BRN3	GN9831-O0	-	○	
	23	2		PTFE 19YF	BRT3	GN7264-V0	-	○	
	25	2		PA 80NP	BRN3	GN9738-O1	-	○	
	25	2		PTFE 19YF	BRT3	GN0749-V0	-	○	
	28	2		PA 80NP	BRN3	GN9104-O1	-	○	
	28	2		PTFE 19YF	BRT3	GN6445-V0	-	○	
16	20	1,25		PTFE 19YF	BRT3	GN0750-A0	-	○	
	24	2		PA 80NP	BRN3	GN9832-O0	-	○	
	24	2		PTFE 19YF	BRT3	GN7265-V0	-	○	
	26	2		PA 80NP	BRN3	GN9105-O1	-	○	
	26	2		PTFE 19YF	BRT3	GN0751-F0	-	○	
	26	2		PTFE 19YF	BRT3	GN0751-V0	-	○	
	32	2		PA 80NP	BRN3	GN9870-O0	-	○	
	32	2		PTFE 19YF	BRT3	GN7288-V0	-	○	
17	25	2		PA 80NP	BRN3	GN9795-O0	-	○	
	25	2		PTFE 19YF	BRT3	GN7239-V0	-	○	
18	22	1,25		PTFE 19YF	BRT3	GN0756-A0	-	○	
	26	2		PA 80NP	BRN3	GN9106-O1	-	○	
	26	2		PTFE 19YF	BRT3	GN6377-V0	-	○	
	28	2		PA 80NP	BRN3	GN9833-O0	-	○	
	28	2		PTFE 19YF	BRT3	GN0757-V0	-	○	
	31	2		PA 80NP	BRN3	GN9107-O1	-	○	
	31	2		PTFE 19YF	BRT3	GN6446-V0	-	○	
	33	2		PTFE 19YF	BRT3	GN7354-V0	-	○	
18,5	31,5	2		PA 80NP	BRN3	GN9796-O0	-	○	
	31,5	2		PTFE 19YF	BRT3	GN7240-V0	-	○	
20	24	1,25		PTFE 19YF	BRT3	GN0761-A0	-	○	
	28	2		PA 80NP	BRN3	GN9108-O1	-	○	
	28	2		PTFE 19YF	BRT3	GN6447-V0	-	○	
	30	2		PA 80NP	BRN3	GN9109-O1	-	○	
	30	2		PTFE 19YF	BRT3	GN0762-F0	-	○	

d [mm]	D [mm]	H [mm]	L [mm]	Material	Design	Part No.	PU ¹⁾	US	EU
20	30	2		PTFE 19YF	BRT3	GN0762-V0	-	○	
	33	2		PA 80NP	BRN3	GN9110-O1	-	○	
	33	2		PTFE 19YF	BRT3	GN6448-V0	-	○	
	35	2		PA 80NP	BRN3	GN9871-O0	-	○	
	35	2		PTFE 19YF	BRT3	GN7289-V0	-	○	
21	25	1,25		PTFE 19YF	BRT3	GN0763-A0	-	○	
21,5	31,5	2		PA 80NP	BRN3	GN9797-O0	-	○	
	31,5	2		PTFE 19YF	BRT3	GN0767-V0	-	○	
22	26	1,25		PTFE 19YF	BRT3	GN0768-A0	-	○	
	28	1,25		PTFE 19YF	BRT3	GN0769-A0	-	○	
	32	2		PA 80NP	BRN3	GN9872-O0	-	○	
	32	2		PTFE 19YF	BRT3	GN7290-V0	-	○	
	35	2		PA 80NP	BRN3	GN9111-O1	-	○	
22,4	35	2		PTFE 19YF	BRT3	GN6449-V0	-	○	
	28,4	1,25		PTFE 19YF	BRT3	GN0770-A0	-	○	
	30	2		PA 80NP	BRN3	GN9112-O1	-	○	
	30	2		PTFE 19YF	BRT3	GN6450-V0	-	○	
	32,4	2		PA 80NP	BRN3	GN9834-O0	-	○	
	32,4	2		PTFE 19YF	BRT3	GN0771-V0	-	○	
	35,4	2		PA 80NP	BRN3	GN9798-O0	-	○	
22,5	35,4	2		PTFE 19YF	BRT3	GN6017-V0	-	○	
	35,5	2		PA 80NP	BRN3	GN9799-O0	-	○	
23,5	35,5	2		PTFE 19YF	BRT3	GN7241-V0	-	○	
	31,5	2		PA 80NP	BRN3	GN9114-O1	-	○	
25	31,5	2		PTFE 19YF	BRT3	GN6452-V0	-	○	
	30	1,25		PTFE 19YF	BRT3	GN0775-A0	-	○	
	30	1,25		PTFE 19YF	BRT3	GN0779-A0	-	○	
	31	1,25		PTFE 19YF	BRT3	GN0780-A0	-	○	
	33	2		PA 80NP	BRN3	GN9786-O1	-	○	
	33	2		PTFE 19YF	BRT3	GN6665-V0	-	○	
	35	2		PA 80NP	BRN3	GN9115-O1	-	○	
	35	2		PTFE 19YF	BRT3	GN0781-F0	-	○	
	35	2		PTFE 19YF	BRT3	GN0781-V0	-	○	
	38	2		PA 80NP	BRN3	GN9116-O1	-	○	
	38	2		PTFE 19YF	BRT3	GN6453-V0	-	○	
	40	2		PA 80NP	BRN3	GN9800-O0	-	○	
	40	2		PTFE 19YF	BRT3	GN6591-V0	-	○	
	45	2		PA 80NP	BRN3	GN9873-O0	-	○	
	45	2		PTFE 19YF	BRT3	GN7291-V0	-	○	
25,5	31,5	1,25		PTFE 19YF	BRT3	GN0782-A0	-	○	
	35,5	2		PA 80NP	BRN3	GN9117-O1	-	○	
	35,5	2		PTFE 19YF	BRT3	GN6454-V0	-	○	
26	32	1,25		PTFE 19YF	BRT3	GN0786-A0	-	○	
27	40	3		PA 80NP	BRN3	GN9118-O1	-	○	
	40	3		PTFE 19YF	BRT3	GN6455-V0	-	○	
28	34	1,25		PTFE 19YF	BRT3	GN0790-A0	-	○	
	35,5	3		PA 80NP	BRN3	GN9119-O1	-	○	
	35,5	3		PTFE 19YF	BRT3	GN6456-V0	-	○	
	38	3		PA 80NP	BRN3	GN9835-O0	-	○	
	38	3		PTFE 19YF	BRT3	GN7268-V0	-	○	

d [mm]	D [mm]	H [mm]	L [mm]	Material	Design	Part No.	PU ¹⁾	US	EU
28	40	3		PA 80NP	BRN3	GN9120-O1	-	○	
	40	3		PTFE 19YF	BRT3	GN6457-V0	-	○	
	41	3		PA 80NP	BRN3	GN9121-O1	-	○	
	41	3		PTFE 19YF	BRT3	GN6458-V0	-	○	
	43	3		PA 80NP	BRN3	GN9836-O0	-	○	
	43	3		PTFE 19YF	BRT3	GN0791-V0	-	○	
29	35	1,25		PTFE 19YF	BRT3	GN0793-A0	-	○	
29,5	35,5	1,25		PTFE 19YF	BRT3	GN0796-A0	-	○	
30	35	1,25		PTFE 19YF	BRT3	GN0797-A0	-	○	
	36	1,25		PTFE 19YF	BRT3	GN0798-A0	-	○	
	40	3		PA 80NP	BRN3	GN9122-O1	-	○	
	40	3		PTFE 19YF	BRT3	GN6361-V0	-	○	
	43	3		PA 80NP	BRN3	GN9123-O1	-	○	
	43	3		PTFE 19YF	BRT3	GN6459-V0	-	○	
	45	3		PA 80NP	BRN3	GN9801-O0	-	○	
	45	3		PTFE 19YF	BRT3	GN7061-V0	-	○	
	46	3		PA 80NP	BRN3	GN9874-O0	-	○	
	46	3		PTFE 19YF	BRT3	GN7292-V0	-	○	
31	37	1,25		PTFE 19YF	BRT3	GN0803-A0	-	○	
31,5	37,5	1,25		PTFE 19YF	BRT3	GN0804-A0	-	○	
	41,5	3		PA 80NP	BRN3	GN9124-O1	-	○	
	41,5	3		PTFE 19YF	BRT3	GN6460-V0	-	○	
	44,5	3		PA 80NP	BRN3	GN9125-O1	-	○	
	44,5	3		PTFE 19YF	BRT3	GN6461-V0	-	○	
	46,5	3		PA 80NP	BRN3	GN9837-O0	-	○	
	46,5	3		PTFE 19YF	BRT3	GN0805-V0	-	○	
32	38	1,25		PTFE 19YF	BRT3	GN0806-A0	-	○	
	45	3		PA 80NP	BRN3	GN9802-O0	-	○	
	45	3		PTFE 19YF	BRT3	GN7242-V0	-	○	
	46	3		PA 80NP	BRN3	GN9875-O0	-	○	
	46	3		PTFE 19YF	BRT3	GN6035-V0	-	○	
	48	3		PTFE 19YF	BRT3	GN7356-V0	-	○	
34	40	1,25		PTFE 19YF	BRT3	GN0813-A0	-	○	
	50	3		PA 80NP	BRN3	GN9126-O1	-	○	
	50	3		PTFE 19YF	BRT3	GN6462-V0	-	○	
35	40	1,25		PTFE 19YF	BRT3	GN0814-A0	-	○	
	41	1,25		PTFE 19YF	BRT3	GN0815-A0	-	○	
	45	3		PA 80NP	BRN3	GN9127-O1	-	○	
	45	3		PTFE 19YF	BRT3	GN6463-V0	-	○	
	50	3		PA 80NP	BRN3	GN9128-O1	-	○	
	50	3		PTFE 19YF	BRT3	GN0816-F0	-	○	
	50	3		PTFE 19YF	BRT3	GN0816-V0	-	○	
	51	3		PTFE 19YF	BRT3	GN7006-V0	-	○	
	35,5	41,5	1,25		PTFE 19YF	BRT3	GN0819-A0	-	○
45		3		PA 80NP	BRN3	GN9129-O1	-	○	
45		3		PTFE 19YF	BRT3	GN6464-V0	-	○	
45,5		3		PA 80NP	BRN3	GN9788-O1	-	○	
45,5		3		PTFE 19YF	BRT3	GN7271-V0	-	○	
50,5		3		PA 80NP	BRN3	GN9954-O0	-	○	
50,5		3		PTFE 19YF	BRT3	GN0820-V0	-	○	

d [mm]	D [mm]	H [mm]	L [mm]	Material	Design	Part No.	PU ¹⁾	US	EU
35,5	51,5	3		PA 80NP	BRN3	GN9130-O1	-	○	
	51,5	3		PTFE 19YF	BRT3	GN6330-V0	-	○	
36	42	1,25		PTFE 19YF	BRT3	GN0822-A0	-	○	
	44	1,25		PTFE 19YF	BRT3	GN0825-A0	-	○	
38	52	3		PA 80NP	BRN3	GN9876-O0	-	○	
	52	3		PTFE 19YF	BRT3	GN6046-V0	-	○	
39	45	1,25		PTFE 19YF	BRT3	GN0829-A0	-	○	
	45	1,25		PTFE 19YF	BRT3	GN0830-A0	-	○	
40	46	1,25		PTFE 19YF	BRT3	GN0831-A0	-	○	
	50	3		PA 80NP	BRN3	GN9131-O1	-	○	
	50	3		PTFE 19YF	BRT3	GN6465-V0	-	○	
	55	3		PA 80NP	BRN3	GN9948-O0	-	○	
	55	3		PTFE 19YF	BRT3	GN6759-V0	-	○	
	56	3		PA 80NP	BRN3	GN9132-O1	-	○	
	56	3		PTFE 19YF	BRT3	GN6466-V0	-	○	
	60	3		PA 80NP	BRN3	GN9877-O0	-	○	
	60	3		PTFE 19YF	BRT3	GN7293-V0	-	○	
	41	47	1,25		PTFE 19YF	BRT3	GN0834-A0	-	○
56		3		PA 80NP	BRN3	GN9949-O0	-	○	
56		3		PTFE 19YF	BRT3	GN0835-V0	-	○	
42	48	1,25		PTFE 19YF	BRT3	GN0839-A0	-	○	
44	50	1,25		PTFE 19YF	BRT3	GN0841-A0	-	○	
	50	1,25		PTFE 19YF	BRT3	GN0843-A0	-	○	
	51	1,25		PTFE 19YF	BRT3	GN0844-A0	-	○	
	55	3		PA 80NP	BRN3	GN9133-O1	-	○	
	55	3		PTFE 19YF	BRT3	GN6467-V0	-	○	
	56	3		PA 80NP	BRN3	GN9134-O1	-	○	
	56	3		PTFE 19YF	BRT3	GN6468-V0	-	○	
	60	3		PA 80NP	BRN3	GN9950-O0	-	○	
	60	3		PTFE 19YF	BRT3	GN0845-V0	-	○	
	61	3		PA 80NP	BRN3	GN9135-O1	-	○	
45	61	3		PTFE 19YF	BRT3	GN6469-V0	-	○	
	52	1,25		PTFE 19YF	BRT3	GN0848-A0	-	○	
	56	3		PA 80NP	BRN3	GN9782-O1	-	○	
	56	3		PTFE 19YF	BRT3	GN7243-V0	-	○	
	60	3		PA 80NP	BRN3	GN9878-O0	-	○	
	60	3		PTFE 19YF	BRT3	GN7294-V0	-	○	
46	63	3		PA 80NP	BRN3	GN9137-O1	-	○	
	63	3		PTFE 19YF	BRT3	GN6471-V0	-	○	
47	54	1,25		PTFE 19YF	BRT3	GN0851-A0	-	○	
	58	1,9		PTFE 19YF	BRT3	GN0852-A0	-	○	
	63	3		PA 80NP	BRN3	GN9951-O0	-	○	
	63	3		PTFE 19YF	BRT3	GN0853-V0	-	○	
48	55	1,25		PTFE 19YF	BRT3	GN0856-A0	-	○	
	55	1,25		PTFE 19YF	BRT3	GN0858-A0	-	○	
49	56	1,25		PTFE 19YF	BRT3	GN0859-A0	-	○	
	60	1,9		PTFE 19YF	BRT3	GN0860-A0	-	○	
	60	3		PA 80NP	BRN3	GN9138-O1	-	○	
	60	3		PTFE 19YF	BRT3	GN6302-V0	-	○	
	63	3		PA 80NP	BRN3	GN9861-O0	-	○	

d [mm]	D [mm]	H [mm]	L [mm]	Material	Design	Part No.	PU ¹⁾	US	EU
50	63	3		PTFE 19YF	BRT3	GN7285-V0	-	○	
	65	3		PA 80NP	BRN3	GN9952-O0	-	○	
	65	3		PTFE 19YF	BRT3	GN6439-V0	-	○	
	66	3		PA 80NP	BRN3	GN9139-O1	-	○	
	66	3		PTFE 19YF	BRT3	GN6329-V0	-	○	
	70	3		PA 80NP	BRN3	GN9529-O0	-	○	
	70	3		PTFE 19YF	BRT3	GN6592-V0	-	○	
51	71	3		PA 80NP	BRN3	GN9805-O0	-	○	
	71	3		PTFE 19YF	BRT3	GN0862-V0	-	○	
52	62	1,9		PTFE 19YF	BRT3	GN0866-A0	-	○	
53	63	1,9		PTFE 19YF	BRT3	GN0868-A0	-	○	
	63	3		PA 80NP	BRN3	GN9140-O1	-	○	
	63	3		PTFE 19YF	BRT3	GN6413-V0	-	○	
	69	3		PA 80NP	BRN3	GN9803-O0	-	○	
	69	3		PTFE 19YF	BRT3	GN7008-V0	-	○	
	73	3		PA 80NP	BRN3	GN9879-O0	-	○	
	73	3		PTFE 19YF	BRT3	GN0869-V0	-	○	
55	60	1,25		PTFE 19YF	BRT3	GN0873-A0	-	○	
	65	1,9		PTFE 19YF	BRT3	GN0874-A0	-	○	
	65	3		PA 80NP	BRN3	GN9141-O1	-	○	
	65	3		PTFE 19YF	BRT3	GN6472-V0	-	○	
	68	3		PA 80NP	BRN3	GN9862-O0	-	○	
	68	3		PTFE 19YF	BRT3	GN7286-V0	-	○	
	70	3		PA 80NP	BRN3	GN9804-O0	-	○	
	70	3		PTFE 19YF	BRT3	GN6408-V0	-	○	
	71	3		PA 80NP	BRN3	GN9142-O1	-	○	
	71	3		PTFE 19YF	BRT3	GN6473-V0	-	○	
	75	3		PA 80NP	BRN3	GN9807-O0	-	○	
	75	3		PTFE 19YF	BRT3	GN7249-V0	-	○	
	80	3		PA 80NP	BRN3	GN9880-O0	-	○	
	80	3		PTFE 19YF	BRT3	GN6072-V0	-	○	
56	66	1,9		PTFE 19YF	BRT3	GN0876-A0	-	○	
	66	3		PA 80NP	BRN3	GN9143-O1	-	○	
	66	3		PTFE 19YF	BRT3	GN6474-V0	-	○	
	71	3		PA 80NP	BRN3	GN9806-O0	-	○	
	71	3		PTFE 19YF	BRT3	GN7247-V0	-	○	
	72	3		PA 80NP	BRN3	GN9838-O0	-	○	
	72	3		PTFE 19YF	BRT3	GN7009-V0	-	○	
	76	3		PA 80NP	BRN3	GN9839-O0	-	○	
76	3		PTFE 19YF	BRT3	GN0877-V0	-	○		
58	68	1,9		PTFE 19YF	BRT3	GN0882-A0	-	○	
	78	3		PA 80NP	BRN3	GN9881-O0	-	○	
	78	3		PTFE 19YF	BRT3	GN7296-V0	-	○	
60	65	1,25		PTFE 19YF	BRT3	GN0884-A0	-	○	
	70	1,9		PTFE 19YF	BRT3	GN0885-A0	-	○	
	70	3		PA 80NP	BRN3	GN9144-O1	-	○	
	70	3		PTFE 19YF	BRT3	GN6444-V0	-	○	
	71	3		PA 80NP	BRN3	GN9145-O1	-	○	
	71	3		PTFE 19YF	BRT3	GN6475-V0	-	○	
	73	3		PA 80NP	BRN3	GN9863-O0	-	○	

d [mm]	D [mm]	H [mm]	L [mm]	Material	Design	Part No.	PU ¹⁾	US	EU
60	73	3		PTFE 19YF	BRT3	GN7287-V0	-	○	
	75	3		PA 80NP	BRN3	GN9808-O0	-	○	
	75	3		PTFE 19YF	BRT3	GN6363-V0	-	○	
	76	3		PA 80NP	BRN3	GN9146-O1	-	○	
	76	3		PTFE 19YF	BRT3	GN6476-V0	-	○	
	80	3		PA 80NP	BRN3	GN9953-O0	-	○	
	80	3		PTFE 19YF	BRT3	GN0886-V1	-	○	
61	71	3		PA 80NP	BRN3	GN9783-O1	-	○	
	71	3		PTFE 19YF	BRT3	GN7248-V0	-	○	
62	72	1,9		PTFE 19YF	BRT3	GN0890-A0	-	○	
	82	3		PA 80NP	BRN3	GN9882-O0	-	○	
	82	3		PTFE 19YF	BRT3	GN6371-V0	-	○	
63	73	1,9		PTFE 19YF	BRT3	GN0892-A0	-	○	
	73	3		PA 80NP	BRN3	GN9147-O1	-	○	
	73	3		PTFE 19YF	BRT3	GN6477-V0	-	○	
	78	3		PA 80NP	BRN3	GN9840-O0	-	○	
	78	3		PTFE 19YF	BRT3	GN6304-V0	-	○	
	79	3		PA 80NP	BRN3	GN9841-O0	-	○	
	79	3		PTFE 19YF	BRT3	GN7010-V0	-	○	
	83	3		PA 80NP	BRN3	GN9842-O0	-	○	
64	83	3		PTFE 19YF	BRT3	GN0893-V1	-	○	
	80	3		PA 80NP	BRN3	GN9148-O1	-	○	
65	80	3		PTFE 19YF	BRT3	GN6478-V0	-	○	
	70	1,25		PTFE 19YF	BRT3	GN0897-A0	-	○	
	75	1,9		PTFE 19YF	BRT3	GN0898-A0	-	○	
	75	3		PA 80NP	BRN3	GN9149-O1	-	○	
	75	3		PTFE 19YF	BRT3	GN6479-V0	-	○	
	78	3		PA 80NP	BRN3	GN9864-O0	-	○	
	78	3		PTFE 19YF	BRT3	GN6798-V0	-	○	
	80	3		PA 80NP	BRN3	GN9754-O1	-	○	
	80	3		PTFE 19YF	BRT3	GN6364-V0	-	○	
	81	3		PTFE 19YF	BRT3	GN7011-V0	-	○	
	85	3		PA 80NP	BRN3	GN9810-O0	-	○	
67	85	3		PTFE 19YF	BRT3	GN0899-V0	-	○	
	77	1,9		PTFE 19YF	BRT3	GN0903-A0	-	○	
	82	3		PA 80NP	BRN3	GN9843-O0	-	○	
	82	3		PTFE 19YF	BRT3	GN7273-V0	-	○	
	87	3		PA 80NP	BRN3	GN9844-O0	-	○	
70	87	3		PTFE 19YF	BRT3	GN0904-V0	-	○	
	75	1,25		PTFE 19YF	BRT3	GN0907-A0	-	○	
	80	1,9		PTFE 19YF	BRT3	GN0909-A0	-	○	
	80	3		PA 80NP	BRN3	GN9092-O1	-	○	
	80	3		PTFE 19YF	BRT3	GN6362-V1	-	○	
	83	3		PA 80NP	BRN3	GN9865-O0	-	○	
	83	3		PTFE 19YF	BRT3	GN6556-V0	-	○	
	85	3		PA 80NP	BRN3	GN9411-O0	-	○	
	85	3		PTFE 19YF	BRT3	GN6442-V0	-	○	
	90	3		PA 80NP	BRN3	GN9151-O1	-	○	
	90	3		PTFE 19YF	BRT3	GN0910-F0	-	○	
	90	3		PTFE 19YF	BRT3	GN0910-V0	-	○	

d [mm]	D [mm]	H [mm]	L [mm]	Material	Design	Part No.	PU ¹⁾	US	EU
	80	3		PA 80NP	BRN3	GN9152-O1	-	○	
	80	3		PTFE 19YF	BRT3	GN6481-V0	-	○	
	81	1,9		PTFE 19YF	BRT3	GN0913-A0	-	○	
	81	3		PA 80NP	BRN3	GN9153-O1	-	○	
71	81	3		PTFE 19YF	BRT3	GN6482-V0	-	○	
	86	3		PA 80NP	BRN3	GN9845-O0	-	○	
	86	3		PTFE 19YF	BRT3	GN6603-V0	-	○	
	91	3		PA 80NP	BRN3	GN9846-O0	-	○	
	91	3		PTFE 19YF	BRT3	GN0914-V0	-	○	
	80	1,25		PTFE 19YF	BRT3	GN0918-A0	-	○	
	85	1,9		PTFE 19YF	BRT3	GN0919-A0	-	○	
	85	3		PA 80NP	BRN3	GN9241-O1	-	○	
	85	3		PTFE 19YF	BRT3	GN6729-V0	-	○	
	88	3		PA 80NP	BRN3	GN9866-O0	-	○	
75	88	3		PTFE 19YF	BRT3	GN6558-V0	-	○	
	90	3		PA 80NP	BRN3	GN9757-O1	-	○	
	90	3		PTFE 19YF	BRT3	GN6443-V0	-	○	
	95	3		PA 80NP	BRN3	GN9154-O1	-	○	
	95	3		PTFE 19YF	BRT3	GN0920-F0	-	○	
	95	3		PTFE 19YF	BRT3	GN0920-V0	-	○	
	85	1,25		PTFE 19YF	BRT3	GN0925-A0	-	○	
	90	1,9		PTFE 19YF	BRT3	GN0926-A0	-	○	
	90	3		PA 80NP	BRN3	GN9155-O1	-	○	
	90	3		PTFE 19YF	BRT3	GN6483-V0	-	○	
	93	3		PA 80NP	BRN3	GN9867-O0	-	○	
80	93	3		PTFE 19YF	BRT3	GN6557-V0	-	○	
	95	3		PA 80NP	BRN3	GN9582-O0	-	○	
	95	3		PTFE 19YF	BRT3	GN6898-V0	-	○	
	100	3		PA 80NP	BRN3	GN9156-O1	-	○	
	100	3		PTFE 19YF	BRT3	GN0927-F0	-	○	
	100	3		PTFE 19YF	BRT3	GN0927-V0	-	○	
	90	1,25		PTFE 19YF	BRT3	GN0930-A0	-	○	
	95	1,9		PTFE 19YF	BRT3	GN0931-A0	-	○	
	100	3		PA 80NP	BRN3	GN9091-O1	-	○	
85	100	3		PTFE 19YF	BRT3	GN6484-V0	-	○	
	105	3		PA 80NP	BRN3	GN9157-O1	-	○	
	105	3		PTFE 19YF	BRT3	GN0932-F0	-	○	
	105	3		PTFE 19YF	BRT3	GN0932-V0	-	○	
	95	1,25		PTFE 19YF	BRT3	GN0937-A0	-	○	
	100	1,9		PTFE 19YF	BRT3	GN0938-A0	-	○	
	105	3		PA 80NP	BRN3	GN9158-O1	-	○	
90	105	3		PTFE 19YF	BRT3	GN6485-V0	-	○	
	110	3		PA 80NP	BRN3	GN9159-O1	-	○	
	110	3		PTFE 19YF	BRT3	GN0939-F0	-	○	
	110	3		PTFE 19YF	BRT3	GN0939-V0	-	○	
	112	3		PA 80NP	BRN3	GN9811-O0	-	○	
92	112	3		PTFE 19YF	BRT3	GN0940-V0	-	○	
	100	1,25		PTFE 19YF	BRT3	GN0943-A0	-	○	
95	105	1,9		PTFE 19YF	BRT3	GN0944-A0	-	○	
	110	3		PA 80NP	BRN3	GN9160-O1	-	○	

d [mm]	D [mm]	H [mm]	L [mm]	Material	Design	Part No.	PU ¹⁾	US	EU
95	110	3		PTFE 19YF	BRT3	GN6486-V0	-	○	
	115	3		PA 80NP	BRN3	GN9161-O1	-	○	
	115	3		PTFE 19YF	BRT3	GN0945-F0	-	○	
	115	3		PTFE 19YF	BRT3	GN0945-V0	-	○	
	120	3		PA 80NP	BRN3	GN9883-O0	-	○	
	120	3		PTFE 19YF	BRT3	GN6716-V0	-	○	
97	112	3		PA 80NP	BRN3	GN9812-O0	-	○	
	112	3		PTFE 19YF	BRT3	GN7250-V0	-	○	
98	112	3		PA 80NP	BRN3	GN9162-O1	-	○	
	112	3		PTFE 19YF	BRT3	GN6487-V0	-	○	
100	105	1,25		PTFE 19YF	BRT3	GN0950-A0	-	○	
	110	1,9		PTFE 19YF	BRT3	GN0951-A0	-	○	
	115	3		PA 80NP	BRN3	GN9163-O1	-	○	
	115	3		PTFE 19YF	BRT3	GN6488-V0	-	○	
	120	3		PA 80NP	BRN3	GN9164-O1	-	○	
	120	3		PTFE 19YF	BRT3	GN0952-F0	-	○	
	120	3		PTFE 19YF	BRT3	GN0952-V0	-	○	
	125	3		PA 80NP	BRN3	GN9884-O0	-	○	
125	3		PTFE 19YF	BRT3	GN7297-V0	-	○		
102	112	1,9		PTFE 19YF	BRT3	GN0954-A0	-	○	
105	110	1,25		PTFE 19YF	BRT3	GN0957-A0	-	○	
	115	1,9		PTFE 19YF	BRT3	GN0958-A0	-	○	
	120	3		PA 80NP	BRN3	GN9589-O1	-	○	
	120	3		PTFE 19YF	BRT3	GN6684-V0	-	○	
	125	3		PA 80NP	BRN3	GN9165-O1	-	○	
	125	3		PTFE 19YF	BRT3	GN0959-F0	-	○	
	125	3		PTFE 19YF	BRT3	GN0959-V0	-	○	
106	120	3		PA 80NP	BRN3	GN9166-O1	-	○	
	120	3		PTFE 19YF	BRT3	GN6489-V0	-	○	
	121	3		PA 80NP	BRN3	GN9789-O1	-	○	
	121	3		PTFE 19YF	BRT3	GN7274-V0	-	○	
	126	3		PA 80NP	BRN3	GN9847-O0	-	○	
	126	3		PTFE 19YF	BRT3	GN0961-V0	-	○	
110	115	1,25		PTFE 19YF	BRT3	GN0964-A0	-	○	
	120	1,9		PTFE 19YF	BRT3	GN0965-A0	-	○	
	125	3		PA 80NP	BRN3	GN9430-O1	-	○	
	125	3		PTFE 19YF	BRT3	GN6761-V0	-	○	
	130	3		PA 80NP	BRN3	GN9694-O0	-	○	
	130	3		PTFE 19YF	BRT3	GN6790-V0	-	○	
112	122	1,9		PTFE 19YF	BRT3	GN0969-A0	-	○	
	127	3		PA 80NP	BRN3	GN9848-O0	-	○	
	127	3		PTFE 19YF	BRT3	GN7275-V0	-	○	
	132	3		PA 80NP	BRN3	GN9168-O1	-	○	
	132	3		PTFE 19YF	BRT3	GN0970-F0	-	○	
	132	3		PTFE 19YF	BRT3	GN0970-V0	-	○	
115	120	1,25		PTFE 19YF	BRT3	GN0972-A0	-	○	
	125	1,9		PTFE 19YF	BRT3	GN0973-A0	-	○	
	130	3		PA 80NP	BRN3	GN9274-O1	-	○	
	130	3		PTFE 19YF	BRT3	GN6741-V0	-	○	
	135	3		PA 80NP	BRN3	GN9778-O1	-	○	

d [mm]	D [mm]	H [mm]	L [mm]	Material	Design	Part No.	PU ¹⁾	US	EU
115	135	3		PTFE 19YF	BRT3	GN0974-V0	-	○	
118	132	3		PA 80NP	BRN3	GN9885-O0	-	○	
	132	3		PTFE 19YF	BRT3	GN7298-V0	-	○	
	133	3		PA 80NP	BRN3	GN9790-O1	-	○	
	133	3		PTFE 19YF	BRT3	GN7276-V0	-	○	
	138	3		PA 80NP	BRN3	GN9849-O0	-	○	
	138	3		PTFE 19YF	BRT3	GN0978-V0	-	○	
120	125	1,25		PTFE 19YF	BRT3	GN0980-A0	-	○	
	130	1,9		PTFE 19YF	BRT3	GN0981-A0	-	○	
	135	3		PA 80NP	BRN3	GN9768-O0	-	○	
	135	3		PTFE 19YF	BRT3	GN6374-V0	-	○	
	140	3		PA 80NP	BRN3	GN9169-O1	-	○	
	140	3		PTFE 19YF	BRT3	GN0982-F0	-	○	
	140	3		PTFE 19YF	BRT3	GN0982-V0	-	○	
125	130	1,25		PTFE 19YF	BRT3	GN0984-A0	-	○	
	135	1,9		PTFE 19YF	BRT3	GN0985-A0	-	○	
	140	3		PA 80NP	BRN3	GN9170-O1	-	○	
	140	3		PTFE 19YF	BRT3	GN6491-V0	-	○	
	145	3		PA 80NP	BRN3	GN9850-O0	-	○	
	145	3		PTFE 19YF	BRT3	GN0986-V0	-	○	
	150	3		PA 80NP	BRN3	GN9171-O1	-	○	
	150	3		PTFE 19YF	BRT3	GN6135-V0	-	○	
130	135	1,25		PTFE 19YF	BRT3	GN0989-A0	-	○	
	140	1,9		PTFE 19YF	BRT3	GN0990-A0	-	○	
	145	3		PA 80NP	BRN3	GN9742-O0	-	○	
	145	3		PTFE 19YF	BRT3	GN6954-V0	-	○	
	150	3		PA 80NP	BRN3	GN9335-O1	-	○	
	150	3		PTFE 19YF	BRT3	GN6925-V0	-	○	
	155	3		PTFE 19YF	BRT3	GN7012-V0	-	○	
132	142	1,9		PTFE 19YF	BRT3	GN0993-A0	-	○	
	152	3		PA 80NP	BRN3	GN9886-O0	-	○	
	152	3		PTFE 19YF	BRT3	GN0994-V0	-	○	
	157	3		PA 80NP	BRN3	GN9813-O0	-	○	
	157	3		PTFE 19YF	BRT3	GN7013-V0	-	○	
135	140	1,25		PTFE 19YF	BRT3	GN0996-A0	-	○	
	145	1,9		PTFE 19YF	BRT3	GN0997-A0	-	○	
	150	3		PA 80NP	BRN3	GN9539-O1	-	○	
	150	3		PTFE 19YF	BRT3	GN6666-V0	-	○	
	155	3		PA 80NP	BRN3	GN9769-O0	-	○	
	155	3		PTFE 19YF	BRT3	GN0998-V0	-	○	
	160	3		PA 80NP	BRN3	GN9172-O1	-	○	
	160	3		PTFE 19YF	BRT3	GN6492-V0	-	○	
136	150	3		PA 80NP	BRN3	GN9173-O1	-	○	
	150	3		PTFE 19YF	BRT3	GN6493-V0	-	○	
140	155	3		PA 80NP	BRN3	GN9410-O1	-	○	
	155	3		PTFE 19YF	BRT3	GN6728-V1	-	○	
	160	3		PA 80NP	BRN3	GN9668-O0	-	○	
	160	3		PTFE 19YF	BRT3	GN1002-V0	-	○	
	165	3		PA 80NP	BRN3	GN9174-O1	-	○	
	165	3		PTFE 19YF	BRT3	GN6494-V0	-	○	

d [mm]	D [mm]	H [mm]	L [mm]	Material	Design	Part No.	PU ¹⁾	US	EU
145	160	3		PA 80NP	BRN3	GN9175-O1	-	○	
	160	3		PTFE 19YF	BRT3	GN6495-V0	-	○	
	165	3		PA 80NP	BRN3	GN9887-O0	-	○	
	165	3		PTFE 19YF	BRT3	GN1007-V0	-	○	
	170	3		PA 80NP	BRN3	GN9176-O1	-	○	
	170	3		PTFE 19YF	BRT3	GN6496-V0	-	○	
150	165	3		PA 80NP	BRN3	GN9177-O1	-	○	
	165	3		PTFE 19YF	BRT3	GN6497-V0	-	○	
	170	3		PA 80NP	BRN3	GN9672-O1	-	○	
	170	3		PTFE 19YF	BRT3	GN1011-V0	-	○	
	175	3		PA 80NP	BRN3	GN9645-O1	-	○	
	175	3		PTFE 19YF	BRT3	GN7014-V0	-	○	
155	170	4		PA 80NP	BRN3	GN9178-O1	-	○	
	170	4		PTFE 19YF	BRT3	GN6498-V0	-	○	
	180	4		PA 80NP	BRN3	GN9179-O1	-	○	
	180	4		PTFE 19YF	BRT3	GN1016-V0	-	○	
160	175	4		PA 80NP	BRN3	GN9180-O1	-	○	
	175	4		PTFE 19YF	BRT3	GN6499-V0	-	○	
	180	4		PA 80NP	BRN3	GN9814-O0	-	○	
	180	4		PTFE 19YF	BRT3	GN6905-V0	-	○	
	185	4		PA 80NP	BRN3	GN9181-O1	-	○	
	185	4		PTFE 19YF	BRT3	GN1020-V0	-	○	
165	180	4		PA 80NP	BRN3	GN9182-O1	-	○	
	180	4		PTFE 19YF	BRT3	GN6500-V0	-	○	
	190	4		PA 80NP	BRN3	GN9815-O0	-	○	
	190	4		PTFE 19YF	BRT3	GN1023-V0	-	○	
170	185	4		PA 80NP	BRN3	GN9791-O1	-	○	
	185	4		PTFE 19YF	BRT3	GN7064-V0	-	○	
	190	4		PA 80NP	BRN3	GN9816-O0	-	○	
	190	4		PTFE 19YF	BRT3	GN6985-V0	-	○	
	195	4		PA 80NP	BRN3	GN9852-O0	-	○	
	195	4		PTFE 19YF	BRT3	GN1027-V0	-	○	
175	190	4		PA 80NP	BRN3	GN9185-O1	-	○	
	190	4		PTFE 19YF	BRT3	GN6503-V0	-	○	
	200	4		PA 80NP	BRN3	GN9186-O1	-	○	
	200	4		PTFE 19YF	BRT3	GN1031-V0	-	○	
180	200	4		PA 80NP	BRN3	GN9187-O1	-	○	
	200	4		PTFE 19YF	BRT3	GN6372-V0	-	○	
	205	4		PA 80NP	BRN3	GN9188-O1	-	○	
	205	4		PTFE 19YF	BRT3	GN1035-V0	-	○	
185	210	4		PA 80NP	BRN3	GN9817-O0	-	○	
	210	4		PTFE 19YF	BRT3	GN1039-V0	-	○	
190	210	4		PA 80NP	BRN3	GN9190-O1	-	○	
	210	4		PTFE 19YF	BRT3	GN6505-V0	-	○	
	215	4		PA 80NP	BRN3	GN9818-O0	-	○	
	215	4		PTFE 19YF	BRT3	GN1042-V0	-	○	
195	220	4		PA 80NP	BRN3	GN9819-O0	-	○	
	220	4		PTFE 19YF	BRT3	GN7253-V0	-	○	
199	219	4		PA 80NP	BRN3	GN9853-O0	-	○	
	219	4		PTFE 19YF	BRT3	GN7279-V0	-	○	

d [mm]	D [mm]	H [mm]	L [mm]	Material	Design	Part No.	PU ¹⁾	US	EU
199	224	4		PA 80NP	BRN3	GN9820-O0	-	○	
	224	4		PTFE 19YF	BRT3	GN1047-V0	-	○	
200	220	4		PA 80NP	BRN3	GN9191-O1	-	○	
	220	4		PTFE 19YF	BRT3	GN6276-V0	-	○	
	225	4		PA 80NP	BRN3	GN9192-O1	-	○	
	225	4		PTFE 19YF	BRT3	GN1050-V0	-	○	
204	224	4		PA 80NP	BRN3	GN9193-O1	-	○	
	224	4		PTFE 19YF	BRT3	GN6506-V0	-	○	
205	225	4		PA 80NP	BRN3	GN9784-O1	-	○	
	225	4		PTFE 19YF	BRT3	GN7255-V0	-	○	
	230	4		PA 80NP	BRN3	GN9557-O1	-	○	
	230	4		PTFE 19YF	BRT3	GN1053-V0	-	○	
	235	4		PA 80NP	BRN3	GN9888-O0	-	○	
	235	4		PTFE 19YF	BRT3	GN7302-V0	-	○	
210	230	4		PA 80NP	BRN3	GN9195-O1	-	○	
	230	4		PTFE 19YF	BRT3	GN6352-V0	-	○	
	235	4		PA 80NP	BRN3	GN9854-O0	-	○	
	235	4		PTFE 19YF	BRT3	GN1057-V0	-	○	
212	237	4		PA 80NP	BRN3	GN9665-O1	-	○	
	237	4		PTFE 19YF	BRT3	GN1058-V0	-	○	
215	240	4		PA 80NP	BRN3	GN9574-O0	-	○	
	240	4		PTFE 19YF	BRT3	GN7256-V0	-	○	
220	240	4		PA 80NP	BRN3	GN9196-O1	-	○	
	240	4		PTFE 19YF	BRT3	GN6508-V0	-	○	
	245	4		PA 80NP	BRN3	GN9670-O0	-	○	
	245	4		PTFE 19YF	BRT3	GN1063-V0	-	○	
224	244	4		PA 80NP	BRN3	GN9855-O0	-	○	
	244	4		PTFE 19YF	BRT3	GN7281-V0	-	○	
	249	4		PA 80NP	BRN3	GN9856-O0	-	○	
	249	4		PTFE 19YF	BRT3	GN7282-V0	-	○	
225	245	4		PA 80NP	BRN3	GN9197-O1	-	○	
	245	4		PTFE 19YF	BRT3	GN6509-V0	-	○	
	250	4		PA 80NP	BRN3	GN9045-O1	-	○	
	250	4		PTFE 19YF	BRT3	GN1065-V0	-	○	
230	250	4		PA 80NP	BRN3	GN9047-O1	-	○	
	250	4		PTFE 19YF	BRT3	GN6510-V0	-	○	
	254	4		PA 80NP	BRN3	GN9890-O0	-	○	
	254	4		PTFE 19YF	BRT3	GN7304-V0	-	○	
	255	4		PA 80NP	BRN3	GN9857-O0	-	○	
	255	4		PTFE 19YF	BRT3	GN1069-V0	-	○	
235	260	4		PA 80NP	BRN3	GN9821-O0	-	○	
	260	4		PTFE 19YF	BRT3	GN7257-V0	-	○	
236	261	4		PA 80NP	BRN3	GN9891-O0	-	○	
	261	4		PTFE 19YF	BRT3	GN6191-V0	-	○	
240	260	4		PA 80NP	BRN3	GN9198-O1	-	○	
	260	4		PTFE 19YF	BRT3	GN6511-V0	-	○	
	265	4		PA 80NP	BRN3	GN9858-O0	-	○	
	265	4		PTFE 19YF	BRT3	GN1073-V0	-	○	
245	270	4		PA 80NP	BRN3	GN9675-O0	-	○	
	270	4		PTFE 19YF	BRT3	GN7258-V0	-	○	

d [mm]	D [mm]	H [mm]	L [mm]	Material	Design	Part No.	PU ¹⁾	US	EU
250	270	4		PA 80NP	BRN3	GN9199-O1	-	○	
	270	4		PTFE 19YF	BRT3	GN6512-V0	-	○	
	275	4		PA 80NP	BRN3	GN9200-O1	-	○	
	275	4		PTFE 19YF	BRT3	GN1078-V0	-	○	
	280	4		PA 80NP	BRN3	GN9432-O1	-	○	
	280	4		PTFE 19YF	BRT3	GN6197-V0	-	○	
255	280	4		PA 80NP	BRN3	GN9201-O1	-	○	
	280	4		PTFE 19YF	BRT3	GN6513-V0	-	○	
260	285	4		PA 80NP	BRN3	GN9202-O1	-	○	
	285	4		PTFE 19YF	BRT3	GN6514-V0	-	○	
	290	4		PA 80NP	BRN3	GN9431-O1	-	○	
	290	4		PTFE 19YF	BRT3	GN1083-V0	-	○	
265	290	4		PA 80NP	BRN3	GN9203-O1	-	○	
	290	4		PTFE 19YF	BRT3	GN6318-V0	-	○	
	295	4		PA 80NP	BRN3	GN9892-O0	-	○	
	295	4		PTFE 19YF	BRT3	GN1085-V0	-	○	
	297	4		PA 80NP	BRN3	GN9204-O1	-	○	
	297	4		PTFE 19YF	BRT3	GN6515-V0	-	○	
270	295	4		PA 80NP	BRN3	GN9205-O1	-	○	
	295	4		PTFE 19YF	BRT3	GN6516-V0	-	○	
	300	4		PA 80NP	BRN3	GN9206-O1	-	○	
	300	4		PTFE 19YF	BRT3	GN1089-V0	-	○	
275	300	4		PA 80NP	BRN3	GN9207-O1	-	○	
	300	4		PTFE 19YF	BRT3	GN6517-V0	-	○	
280	305	4		PA 80NP	BRN3	GN9208-O1	-	○	
	305	4		PTFE 19YF	BRT3	GN6518-V0	-	○	
	310	4		PA 80NP	BRN3	GN9859-O0	-	○	
	310	4		PTFE 19YF	BRT3	GN1093-V0	-	○	
	312	4		PA 80NP	BRN3	GN9209-O1	-	○	
	312	4		PTFE 19YF	BRT3	GN6519-V0	-	○	
283	315	4		PTFE 19YF	BRT3	GN7358-V0	-	○	
290	315	4		PA 80NP	BRN3	GN9210-O1	-	○	
	315	4		PTFE 19YF	BRT3	GN6520-V0	-	○	
	320	4		PA 80NP	BRN3	GN9860-O0	-	○	
	320	4		PTFE 19YF	BRT3	GN1098-V0	-	○	
300	325	4		PA 80NP	BRN3	GN9211-O1	-	○	
	325	4		PTFE 19YF	BRT3	GN6521-V0	-	○	
	330	4		PA 80NP	BRN3	GN9235-O1	-	○	
	330	4		PTFE 19YF	BRT3	GN1103-V0	-	○	
	332	4		PA 80NP	BRN3	GN9212-O1	-	○	
	332	4		PTFE 19YF	BRT3	GN6522-V0	-	○	

STÜTZRING GESCHLITZT | KESIKLI DESTEK HALKASI DZIELONY PIERŚCIEŃ PODPOROWY | РАЗРЕЗНЫЕ ОПОРНЫЕ КОЛЬЦА

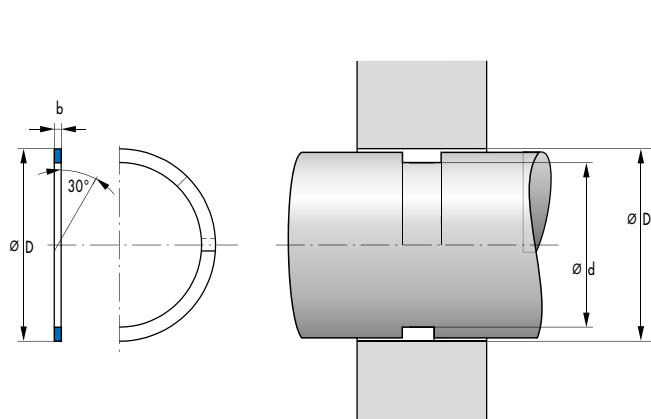

Wenn Sie Ihre Dichtung nicht finden können – Ihre Lösung auf Seite 12
 Aradığınız ürünü bulamadığınız takdirde – çözümünüz sayfa 12
 Jeżeli nie możecie Państwo znaleźć uszczelki – rozwiązanie znajduje się na stronie 12
 Вы не можете подобрать необходимое уплотнение? – Решение на странице 12

1) IP = Industriepackung | Endüstriyel ambalaj | Opakowania przemysłowe | Производственная тара
 SP = Einzelpackung | Tek bir Paket | Pojedyncze opakowanie | Single Pack

● Auf Lager | Stoklarda mevcuttur | Dostępne w magazynie | Имеется в наличии на складе
 ○ Auf Anfrage | Talep üzerine | Na zapytanie | По запросу

d [mm]	D [mm]	H [mm]	L [mm]	Material	Design	Part No.	PU ¹⁾	US	EU
3	6	1,25		PTFE 19YF	BRT2	GN0367-A3	–	○	
4	7	1,25		PTFE 19YF	BRT2	GN0370-A2	–	○	
5	8	1,25		PTFE 19YF	BRT2	GN0372-A3	–	○	
6	9	1,25		PTFE 19YF	BRT2	GN0375-A2	–	○	
7	10	1,25		PTFE 19YF	BRT2	GN0378-A2	–	○	
8	11	1,25		PTFE 19YF	BRT2	GN0380-A5	–	○	
9	12	1,25		PTFE 19YF	BRT2	GN0382-A4	–	○	
10	13	1,25		PTFE 19YF	BRT2	GN0386-A2	–	○	
	14	1,25		PTFE 19YF	BRT2	GN0387-A0	–	○	
10	18	2		PTFE 19YF	BRT2	GN5418-V0	–	○	
	11	1,25		PTFE 19YF	BRT2	GN0389-A0	–	○	
11,2	15,2	1,25		PTFE 19YF	BRT2	GN0390-A0	–	○	
12	16	1,25		PTFE 19YF	BRT2	GN0393-A0	–	○	
	20	2		PTFE 19YF	BRT2	GN5723-V0	–	○	
12,5	16,5	1,25		PTFE 19YF	BRT2	GN0395-A0	–	○	
	20	2		PTFE 19YF	BRT2	GN5724-V0	–	○	
14	18	1,25		PTFE 19YF	BRT2	GN0398-A0	–	○	
	22	2		PTFE 19YF	BRT2	GN5719-V0	–	○	
15	19	1,25		PTFE 19YF	BRT2	GN0401-A0	–	○	
16	20	1,25		PTFE 19YF	BRT2	GN0402-A0	–	○	
	24	2		PTFE 19YF	BRT2	GN5720-V0	–	○	
17	25	2		PTFE 19YF	BRT2	GN5725-V0	–	○	
	22	1,25		PTFE 19YF	BRT2	GN0408-A0	–	○	
18	26	2		PA 80NP	BRN2	GN9106-O0	–	○	
	26	2		PTFE 19YF	BRT2	GN4778-V0	–	○	
20	24	1,25		PTFE 19YF	BRT2	GN0413-A0	–	○	
	28	2		PA 80NP	BRN2	GN9108-O0	–	○	
	28	2		PTFE 19YF	BRT2	GN4780-V0	–	○	
	30	2		PTFE 19YF	BRT2	GN4781-V0	–	○	
21	25	1,25		PTFE 19YF	BRT2	GN0414-A0	–	○	

d [mm]	D [mm]	H [mm]	L [mm]	Material	Design	Part No.	PU ¹⁾	US	EU
22	26	1,25		PTFE 19YF	BRT2	GN0418-A0	-	○	
	28	1,25		PTFE 19YF	BRT2	GN0419-A0	-	○	
	30	2		PTFE 19YF	BRT2	GN5726-V0	-	○	
22,4	28,4	1,25		PTFE 19YF	BRT2	GN0420-A0	-	○	
	30	2		PA 80NP	BRN2	GN9112-O0	-	○	
	30	2		PTFE 19YF	BRT2	GN4784-V0	-	○	
	30,4	2		PA 80NP	BRN2	GN9785-O0	-	○	
	30,4	2		PTFE 19YF	BRT2	GN5714-V0	-	○	
23,5	31,5	2		PA 80NP	BRN2	GN9114-O0	-	○	
	31,5	2		PTFE 19YF	BRT2	GN4786-V0	-	○	
24	30	1,25		PTFE 19YF	BRT2	GN0425-A0	-	○	
	32	2		PTFE 19YF	BRT2	GN5727-V0	-	○	
25	30	1,25		PTFE 19YF	BRT2	GN0429-A0	-	○	
	31	1,25		PTFE 19YF	BRT2	GN0430-A0	-	○	
	33	2		PA 80NP	BRN2	GN9786-O0	-	○	
	33	2		PTFE 19YF	BRT2	GN5019-V1	-	○	
	35	2		PA 80NP	BRN2	GN9115-O0	-	○	
	35	2		PTFE 19YF	BRT2	GN4787-V0	-	○	
25,5	31,5	1,25		PTFE 19YF	BRT2	GN0431-A0	-	○	
26	32	1,25		PTFE 19YF	BRT2	GN0435-A0	-	○	
	34	3		PTFE 19YF	BRT2	GN5728-V0	-	○	
27	35	3		PA 80NP	BRN2	GN9780-O0	-	○	
	35	3		PTFE 19YF	BRT2	GN5707-V0	-	○	
27,5	35,5	3		PA 80NP	BRN2	GN9781-O0	-	○	
	35,5	3		PTFE 19YF	BRT2	GN5708-V0	-	○	
28	34	1,25		PTFE 19YF	BRT2	GN0439-A0	-	○	
	35,5	3		PA 80NP	BRN2	GN9119-O0	-	○	
	35,5	3		PTFE 19YF	BRT2	GN4791-V0	-	○	
	36	3		PA 80NP	BRN2	GN9787-O0	-	○	
	36	3		PTFE 19YF	BRT2	GN5715-V0	-	○	
29	35	1,25		PTFE 19YF	BRT2	GN0441-A0	-	○	
29,5	35,5	1,25		PTFE 19YF	BRT2	GN0444-A0	-	○	
30	35	1,25		PTFE 19YF	BRT2	GN0445-A0	-	○	
	36	1,25		PTFE 19YF	BRT2	GN0446-A0	-	○	
	38	3		PTFE 19YF	BRT2	GN5729-V0	-	○	
	40	2		PTFE 19YF	BRT2	GN4662-V0	-	○	
	40	3		PA 80NP	BRN2	GN9122-O0	-	○	
	40	3		PTFE 19YF	BRT2	GN4794-V0	-	○	
	31	37	1,25		PTFE 19YF	BRT2	GN0451-A0	-	○
31,5	37,5	1,25		PTFE 19YF	BRT2	GN0452-A0	-	○	
	41,5	3		PA 80NP	BRN2	GN9124-O0	-	○	
	41,5	3		PTFE 19YF	BRT2	GN4796-V0	-	○	
32	38	1,25		PTFE 19YF	BRT2	GN0453-A0	-	○	
	42	3		PTFE 19YF	BRT2	GN5730-V0	-	○	
33	43	3		PTFE 19YF	BRT2	GN5731-V0	-	○	
34	40	1,25		PTFE 19YF	BRT2	GN0460-A0	-	○	
	44	3		PTFE 19YF	BRT2	GN5732-V0	-	○	
35	40	1,25		PTFE 19YF	BRT2	GN0461-A0	-	○	
	41	1,25		PTFE 19YF	BRT2	GN0462-A0	-	○	
	45	2		PTFE 19YF	BRT2	GN5765-V0	-	○	

d [mm]	D [mm]	H [mm]	L [mm]	Material	Design	Part No.	PU ¹⁾	US	EU
35	45	3		PA 80NP	BRN2	GN9127-00	-	○	
	45	3		PTFE 19YF	BRT2	GN4799-V0	-	○	
35,5	41,5	1,25		PTFE 19YF	BRT2	GN0465-A0	-	○	
	45	3		PA 80NP	BRN2	GN9129-00	-	○	
	45	3		PTFE 19YF	BRT2	GN4801-V0	-	○	
	45,5	3		PA 80NP	BRN2	GN9788-00	-	○	
	45,5	3		PTFE 19YF	BRT2	GN5716-V0	-	○	
36	42	1,25		PTFE 19YF	BRT2	GN0467-A0	-	○	
	46	3		PA 80NP	BRN2	GN3033-00	-	○	
	46	3		PTFE 19YF	BRT2	GN5733-V0	-	○	
38	44	1,25		PTFE 19YF	BRT2	GN0470-A0	-	○	
	48	3		PTFE 19YF	BRT2	GN5365-V0	-	○	
39	45	1,25		PTFE 19YF	BRT2	GN0475-A0	-	○	
40	45	1,25		PTFE 19YF	BRT2	GN0476-A0	-	○	
	46	1,25		PTFE 19YF	BRT2	GN0477-A0	-	○	
	50	2		PTFE 19YF	BRT2	GN4672-V0	-	○	
	50	3		PA 80NP	BRN2	GN9131-00	-	○	
	50	3		PTFE 19YF	BRT2	GN4050-V0	-	○	
41	47	1,25		PTFE 19YF	BRT2	GN0479-A0	-	○	
42	48	1,25		PTFE 19YF	BRT2	GN0483-A0	-	○	
44	50	1,25		PTFE 19YF	BRT2	GN0485-A0	-	○	
45	50	1,25		PTFE 19YF	BRT2	GN0488-A0	-	○	
	51	1,25		PTFE 19YF	BRT2	GN0489-A0	-	○	
	55	2		PTFE 19YF	BRT2	GN5480-V0	-	○	
	55	3		PA 80NP	BRN2	GN9133-00	-	○	
	55	3		PTFE 19YF	BRT2	GN4804-V0	-	○	
	56	3		PA 80NP	BRN2	GN9134-00	-	○	
	56	3		PTFE 19YF	BRT2	GN4805-V0	-	○	
46	52	1,25		PTFE 19YF	BRT2	GN0492-A0	-	○	
	56	3		PA 80NP	BRN2	GN9782-00	-	○	
	56	3		PTFE 19YF	BRT2	GN5709-V0	-	○	
48	54	1,25		PTFE 19YF	BRT2	GN0495-A0	-	○	
	58	1,9		PTFE 19YF	BRT2	GN0496-A0	-	○	
49	55	1,25		PTFE 19YF	BRT2	GN0499-A0	-	○	
50	55	1,25		PTFE 19YF	BRT2	GN0501-A0	-	○	
	56	1,25		PTFE 19YF	BRT2	GN0502-A0	-	○	
	60	1,9		PTFE 19YF	BRT2	GN0503-A0	-	○	
	60	2		PTFE 19YF	BRT2	GN4976-V0	-	○	
	60	3		PA 80NP	BRN2	GN9138-00	-	○	
	60	3		PTFE 19YF	BRT2	GN4335-V0	-	○	
52	62	1,9		PTFE 19YF	BRT2	GN0507-A0	-	○	
53	63	1,9		PTFE 19YF	BRT2	GN0509-A0	-	○	
	63	2		PTFE 19YF	BRT2	GN5511-V0	-	○	
	63	3		PA 80NP	BRN2	GN9140-00	-	○	
	63	3		PTFE 19YF	BRT2	GN4693-V0	-	○	
55	60	1,25		PTFE 19YF	BRT2	GN0514-A0	-	○	
	65	1,9		PTFE 19YF	BRT2	GN0515-A0	-	○	
	65	2,5		PTFE 19YF	BRT2	GN5766-V0	-	○	
	65	3		PA 80NP	BRN2	GN9141-00	-	○	
	65	3		PTFE 19YF	BRT2	GN4810-V0	-	○	

d [mm]	D [mm]	H [mm]	L [mm]	Material	Design	Part No.	PU ¹⁾	US	EU
56	66	1,9		PTFE 19YF	BRT2	GN0516-A0	-	○	
	66	3		PA 80NP	BRN2	GN9143-O0	-	○	
	66	3		PTFE 19YF	BRT2	GN4766-V0	-	○	
58	68	1,9		PTFE 19YF	BRT2	GN0521-A0	-	○	
	68	3		PTFE 19YF	BRT2	GN5641-V0	-	○	
60	65	1,25		PTFE 19YF	BRT2	GN0523-A0	-	○	
	70	1,9		PTFE 19YF	BRT2	GN0524-A0	-	○	
	70	2,5		PTFE 19YF	BRT2	GN5525-V0	-	○	
	70	3		PA 80NP	BRN2	GN9144-O0	-	○	
	70	3		PTFE 19YF	BRT2	GN4676-V0	-	○	
	71	3		PA 80NP	BRN2	GN9145-O0	-	○	
	71	3		PTFE 19YF	BRT2	GN4812-V0	-	○	
61	71	3		PA 80NP	BRN2	GN9783-O0	-	○	
	71	3		PTFE 19YF	BRT2	GN4629-V0	-	○	
62	72	1,9		PTFE 19YF	BRT2	GN0529-A0	-	○	
	75	3		PTFE 19YF	BRT2	GN5712-V0	-	○	
63	73	1,9		PTFE 19YF	BRT2	GN0531-A0	-	○	
	73	3		PA 80NP	BRN2	GN9147-O0	-	○	
	73	3		PTFE 19YF	BRT2	GN4814-V0	-	○	
65	70	1,25		PTFE 19YF	BRT2	GN0535-A0	-	○	
	75	1,9		PTFE 19YF	BRT2	GN0536-A0	-	○	
	75	2,5		PTFE 19YF	BRT2	GN5767-V0	-	○	
	75	3		PA 80NP	BRN2	GN9149-O0	-	○	
	75	3		PTFE 19YF	BRT2	GN4816-V0	-	○	
	80	3		PTFE 19YF	BRT2	GN4549-V0	-	○	
67	77	1,9		PTFE 19YF	BRT2	GN0540-A0	-	○	
	77	3		PA 80NP	BRN2	GN9150-O0	-	○	
	77	3		PTFE 19YF	BRT2	GN4697-V0	-	○	
	80	2,5		PTFE 19YF	BRT2	GN5768-V0	-	○	
70	75	1,25		PTFE 19YF	BRT2	GN0543-A0	-	○	
	80	1,9		PTFE 19YF	BRT2	GN0545-A0	-	○	
	80	3		PA 80NP	BRN2	GN9092-O0	-	○	
	80	3		PTFE 19YF	BRT2	GN4651-V0	-	○	
71	85	3		PTFE 19YF	BRT2	GN4876-V0	-	○	
	80	3		PA 80NP	BRN2	GN9152-O0	-	○	
	80	3		PTFE 19YF	BRT2	GN4818-V0	-	○	
	81	1,9		PTFE 19YF	BRT2	GN0548-A0	-	○	
	81	3		PA 80NP	BRN2	GN9153-O0	-	○	
	81	3		PTFE 19YF	BRT2	GN4819-V0	-	○	
72	85	2,5		PTFE 19YF	BRT2	GN5769-V0	-	○	
75	80	1,25		PTFE 19YF	BRT2	GN0552-A0	-	○	
	85	1,9		PTFE 19YF	BRT2	GN0553-A0	-	○	
	85	3		PA 80NP	BRN2	GN9241-O0	-	○	
	85	3		PTFE 19YF	BRT2	GN4692-V0	-	○	
	90	3		PTFE 19YF	BRT2	GN4971-V0	-	○	
77	90	2,5		PTFE 19YF	BRT2	GN5770-V0	-	○	
80	85	1,25		PTFE 19YF	BRT2	GN0558-A0	-	○	
	90	1,9		PTFE 19YF	BRT2	GN0559-A0	-	○	
	90	3		PA 80NP	BRN2	GN9155-O0	-	○	
	90	3		PTFE 19YF	BRT2	GN4820-V0	-	○	

d [mm]	D [mm]	H [mm]	L [mm]	Material	Design	Part No.	PU ¹⁾	US	EU
80	95	3		PTFE 19YF	BRT2	GN5023-V0	-	○	
85	90	1,25		PTFE 19YF	BRT2	GN0562-A0	-	○	
	95	1,9		PTFE 19YF	BRT2	GN0563-A0	-	○	
	95	3		PTFE 19YF	BRT2	GN4757-V0	-	○	
	100	3		PA 80NP	BRN2	GN9091-O0	-	○	
	100	3		PTFE 19YF	BRT2	GN4687-V0	-	○	
86	105	3		PTFE 19YF	BRT2	GN4821-V0	-	○	
	100	3		PTFE 19YF	BRT2	GN4982-V1	-	○	
89	104	3		PTFE 19YF	BRT2	GN5734-V0	-	○	
90	95	1,25		PTFE 19YF	BRT2	GN0568-A0	-	○	
	100	1,9		PTFE 19YF	BRT2	GN0569-A0	-	○	
	100	3		PTFE 19YF	BRT2	GN5735-V0	-	○	
	105	3		PA 80NP	BRN2	GN9158-O0	-	○	
	105	3		PTFE 19YF	BRT2	GN4698-V0	-	○	
	110	3		PTFE 19YF	BRT2	GN4109-V0	-	○	
95	100	1,25		PTFE 19YF	BRT2	GN0572-A0	-	○	
	105	1,9		PTFE 19YF	BRT2	GN0573-A0	-	○	
	110	3		PA 80NP	BRN2	GN9160-O0	-	○	
	110	3		PTFE 19YF	BRT2	GN4822-V0	-	○	
96	115	3		PTFE 19YF	BRT2	GN4823-V0	-	○	
	111	3		PTFE 19YF	BRT2	GN5736-V0	-	○	
98	112	3		PA 80NP	BRN2	GN9162-O0	-	○	
	112	3		PTFE 19YF	BRT2	GN4824-V0	-	○	
100	105	1,25		PTFE 19YF	BRT2	GN0578-A0	-	○	
	110	1,9		PTFE 19YF	BRT2	GN0579-A0	-	○	
	115	3		PA 80NP	BRN2	GN9163-O0	-	○	
	115	3		PTFE 19YF	BRT2	GN4512-V0	-	○	
	120	3		PTFE 19YF	BRT2	GN4119-V0	-	○	
102	112	1,9		PTFE 19YF	BRT2	GN0581-A0	-	○	
105	110	1,25		PTFE 19YF	BRT2	GN0584-A0	-	○	
	115	1,9		PTFE 19YF	BRT2	GN0585-A0	-	○	
	120	3		PA 80NP	BRN2	GN9589-O0	-	○	
	120	3		PTFE 19YF	BRT2	GN5198-V0	-	○	
	125	3		PTFE 19YF	BRT2	GN4825-V0	-	○	
106	120	3		PA 80NP	BRN2	GN9166-O0	-	○	
	120	3		PTFE 19YF	BRT2	GN4826-V0	-	○	
	121	3		PA 80NP	BRN2	GN9789-O0	-	○	
	121	3		PTFE 19YF	BRT2	GN5717-V0	-	○	
110	115	1,25		PTFE 19YF	BRT2	GN0589-A0	-	○	
	120	1,9		PTFE 19YF	BRT2	GN0590-A0	-	○	
	125	3		PA 80NP	BRN2	GN9430-O0	-	○	
	125	3		PTFE 19YF	BRT2	GN4480-V0	-	○	
	130	3		PTFE 19YF	BRT2	GN4280-V1	-	○	
	122	1,9		PTFE 19YF	BRT2	GN0593-A0	-	○	
112	125	3		PA 80NP	BRN2	GN9167-O0	-	○	
	125	3		PTFE 19YF	BRT2	GN4827-V0	-	○	
115	120	1,25		PTFE 19YF	BRT2	GN0595-A0	-	○	
	125	1,9		PTFE 19YF	BRT2	GN0596-A0	-	○	
	130	3		PA 80NP	BRN2	GN9274-O0	-	○	
	130	3		PTFE 19YF	BRT2	GN4593-V0	-	○	

d [mm]	D [mm]	H [mm]	L [mm]	Material	Design	Part No.	PU ¹⁾	US	EU
115	135	3		PTFE 19YF	BRT2	GN4574-V0	-	○	
	132	3		PTFE 19YF	BRT2	GN5414-V0	-	○	
118	133	3		PA 80NP	BRN2	GN9790-O0	-	○	
	133	3		PTFE 19YF	BRT2	GN5718-V0	-	○	
	125	1,25		PTFE 19YF	BRT2	GN0601-A0	-	○	
	130	1,9		PTFE 19YF	BRT2	GN0602-A0	-	○	
120	135	3		PA 80NP	BRN2	GN9679-O0	-	○	
	135	3		PTFE 19YF	BRT2	GN5036-V0	-	○	
	140	3		PTFE 19YF	BRT2	GN4132-V0	-	○	
	130	1,25		PTFE 19YF	BRT2	GN0604-A0	-	○	
125	135	1,9		PTFE 19YF	BRT2	GN0605-A0	-	○	
	140	3		PA 80NP	BRN2	GN9170-O0	-	○	
	140	3		PTFE 19YF	BRT2	GN4481-V0	-	○	
	135	1,25		PTFE 19YF	BRT2	GN0608-A0	-	○	
	140	1,9		PTFE 19YF	BRT2	GN0609-A0	-	○	
130	145	3		PA 80NP	BRN2	GN9742-O1	-	○	
	145	3		PTFE 19YF	BRT2	GN4628-V1	-	○	
	150	3		PTFE 19YF	BRT2	GN4142-V0	-	○	
132	142	1,9		PTFE 19YF	BRT2	GN0611-A0	-	○	
	145	3		PTFE 19YF	BRT2	GN5737-V0	-	○	
	140	1,25		PTFE 19YF	BRT2	GN0613-A0	-	○	
135	145	1,9		PTFE 19YF	BRT2	GN0614-A0	-	○	
	150	3		PA 80NP	BRN2	GN9539-O0	-	○	
	150	3		PTFE 19YF	BRT2	GN5025-V0	-	○	
136	150	3		PA 80NP	BRN2	GN9173-O0	-	○	
	150	3		PTFE 19YF	BRT2	GN4830-V0	-	○	
	145	1,25		PTFE 19YF	BRT2	GN0616-A0	-	○	
140	150	1,9		PTFE 19YF	BRT2	GN0617-A0	-	○	
	155	3		PA 80NP	BRN2	GN9410-O0	-	○	
	155	3		PTFE 19YF	BRT2	GN4526-V0	-	○	
	150	1,25		PTFE 19YF	BRT2	GN0620-A0	-	○	
145	155	1,9		PTFE 19YF	BRT2	GN0621-A0	-	○	
	160	3		PA 80NP	BRN2	GN9175-O0	-	○	
	160	3		PTFE 19YF	BRT2	GN4551-V0	-	○	
	160	1,9		PTFE 19YF	BRT2	GN0623-A0	-	○	
	160	1,9		PTFE 19YF	BRT2	GN0623-A2	-	○	
150	165	2,75		PTFE 19YF	BRT2	GN0624-A0	-	○	
	165	3		PA 80NP	BRN2	GN9177-O0	-	○	
	165	3		PTFE 19YF	BRT2	GN4833-V0	-	○	
	165	1,9		PTFE 19YF	BRT2	GN0627-A0	-	○	
155	170	2,75		PTFE 19YF	BRT2	GN0628-A0	-	○	
	170	4		PA 80NP	BRN2	GN9178-O0	-	○	
	170	4		PTFE 19YF	BRT2	GN4834-V0	-	○	
	170	1,9		PTFE 19YF	BRT2	GN0630-A0	-	○	
160	175	2,75		PTFE 19YF	BRT2	GN0631-A0	-	○	
	175	4		PA 80NP	BRN2	GN9180-O0	-	○	
	175	4		PTFE 19YF	BRT2	GN4835-V0	-	○	
	175	1,9		PTFE 19YF	BRT2	GN0632-A0	-	○	
165	180	2,75		PTFE 19YF	BRT2	GN0633-A0	-	○	
	180	4		PA 80NP	BRN2	GN9182-O0	-	○	

d [mm]	D [mm]	H [mm]	L [mm]	Material	Design	Part No.	PU ¹⁾	US	EU
165	180	4		PTFE 19YF	BRT2	GN4836-V0	-	○	
	180	1,9		PTFE 19YF	BRT2	GN0635-A0	-	○	
	185	2,75		PTFE 19YF	BRT2	GN0636-A0	-	○	
170	185	4		PA 80NP	BRN2	GN9791-O0	-	○	
	185	4		PTFE 19YF	BRT2	GN5464-V0	-	○	
	190	4		PTFE 19YF	BRT2	GN4529-V0	-	○	
	185	1,9		PTFE 19YF	BRT2	GN0638-A0	-	○	
175	190	2,75		PTFE 19YF	BRT2	GN0639-A0	-	○	
	190	4		PA 80NP	BRN2	GN9185-O0	-	○	
	190	4		PTFE 19YF	BRT2	GN4839-V0	-	○	
	190	1,9		PTFE 19YF	BRT2	GN0641-A0	-	○	
180	195	2,75		PTFE 19YF	BRT2	GN0642-A0	-	○	
	200	4		PA 80NP	BRN2	GN9187-O0	-	○	
	200	4		PTFE 19YF	BRT2	GN4470-V0	-	○	
185	195	1,9		PTFE 19YF	BRT2	GN0644-A0	-	○	
	200	2,75		PTFE 19YF	BRT2	GN0645-A0	-	○	
	200	1,9		PTFE 19YF	BRT2	GN0646-A0	-	○	
	205	2,75		PTFE 19YF	BRT2	GN0647-A0	-	○	
190	210	4		PA 80NP	BRN2	GN9190-O0	-	○	
	210	4		PTFE 19YF	BRT2	GN4841-V0	-	○	
	215	4		PTFE 19YF	BRT2	GN4577-V0	-	○	
	205	1,9		PTFE 19YF	BRT2	GN0649-A0	-	○	
195	210	2,75		PTFE 19YF	BRT2	GN0650-A0	-	○	
	215	4		PTFE 19YF	BRT2	GN5746-V0	-	○	
	210	1,9		PTFE 19YF	BRT2	GN0652-A0	-	○	
	215	2,75		PTFE 19YF	BRT2	GN0653-A0	-	○	
200	220	4		PA 80NP	BRN2	GN9191-O0	-	○	
	220	4		PTFE 19YF	BRT2	GN4385-V0	-	○	
	225	4		PTFE 19YF	BRT2	GN4560-V0	-	○	
204	224	4		PA 80NP	BRN2	GN9193-O0	-	○	
	224	4		PTFE 19YF	BRT2	GN4842-V0	-	○	
	220	2,75		PTFE 19YF	BRT2	GN0655-A0	-	○	
205	225	4		PA 80NP	BRN2	GN9784-O0	-	○	
	225	4		PTFE 19YF	BRT2	GN5710-V0	-	○	
209	224	2,75		PTFE 19YF	BRT2	GN0656-A0	-	○	
	220	1,9		PTFE 19YF	BRT2	GN0657-A0	-	○	
	225	2,75		PTFE 19YF	BRT2	GN0658-A0	-	○	
210	230	4		PA 80NP	BRN2	GN9195-O0	-	○	
	230	4		PTFE 19YF	BRT2	GN4627-V0	-	○	
	235	4		PTFE 19YF	BRT2	GN5758-V0	-	○	
215	230	2,75		PTFE 19YF	BRT2	GN0659-A0	-	○	
	230	1,9		PTFE 19YF	BRT2	GN0661-A0	-	○	
	235	2,75		PTFE 19YF	BRT2	GN0662-A0	-	○	
220	240	4		PA 80NP	BRN2	GN9196-O0	-	○	
	240	4		PTFE 19YF	BRT2	GN4444-V0	-	○	
	245	4		PTFE 19YF	BRT2	GN5754-V0	-	○	
224	244	4		PTFE 19YF	BRT2	GN5132-V0	-	○	
	240	2,75		PTFE 19YF	BRT2	GN0663-A0	-	○	
225	245	4		PA 80NP	BRN2	GN9197-O0	-	○	
	245	4		PTFE 19YF	BRT2	GN4844-V0	-	○	

d [mm]	D [mm]	H [mm]	L [mm]	Material	Design	Part No.	PU ¹⁾	US	EU
230	240	1,9		PTFE 19YF	BRT2	GN0665-A0	-	○	
	245	2,75		PTFE 19YF	BRT2	GN0666-A0	-	○	
	250	4		PA 80NP	BRN2	GN9047-00	-	○	
	250	4		PTFE 19YF	BRT2	GN4635-V0	-	○	
235	250	2,75		PTFE 19YF	BRT2	GN0667-A0	-	○	
240	250	1,9		PTFE 19YF	BRT2	GN0668-A0	-	○	
	255	2,75		PTFE 19YF	BRT2	GN0669-A0	-	○	
	260	4		PA 80NP	BRN2	GN9198-00	-	○	
	260	4		PTFE 19YF	BRT2	GN4845-V0	-	○	
	265	4		PTFE 19YF	BRT2	GN4428-V1	-	○	
245	260	2,75		PTFE 19YF	BRT2	GN0671-A0	-	○	
250	260	1,9		PTFE 19YF	BRT2	GN0672-A0	-	○	
	265	2,75		PTFE 19YF	BRT2	GN0673-A0	-	○	
	270	4		PA 80NP	BRN2	GN9199-00	-	○	
	270	4		PTFE 19YF	BRT2	GN4459-V0	-	○	
255	270	2,75		PTFE 19YF	BRT2	GN0675-A0	-	○	
	280	4		PA 80NP	BRN2	GN9201-00	-	○	
	280	4		PTFE 19YF	BRT2	GN4846-V0	-	○	
260	270	1,9		PTFE 19YF	BRT2	GN0676-A0	-	○	
	275	2,75		PTFE 19YF	BRT2	GN0677-A0	-	○	
	280	4		PTFE 19YF	BRT2	GN5563-V0	-	○	
	285	4		PA 80NP	BRN2	GN9202-00	-	○	
	285	4		PTFE 19YF	BRT2	GN4847-V0	-	○	
265	280	2,75		PTFE 19YF	BRT2	GN0678-A0	-	○	
	290	4		PA 80NP	BRN2	GN9203-00	-	○	
	290	4		PTFE 19YF	BRT2	GN4848-V0	-	○	
270	280	1,9		PTFE 19YF	BRT2	GN0680-A0	-	○	
	285	2,75		PTFE 19YF	BRT2	GN0681-A0	-	○	
	295	4		PA 80NP	BRN2	GN9205-00	-	○	
	295	4		PTFE 19YF	BRT2	GN4850-V0	-	○	
275	290	2,75		PTFE 19YF	BRT2	GN0682-A0	-	○	
	300	4		PA 80NP	BRN2	GN9207-00	-	○	
	300	4		PTFE 19YF	BRT2	GN4852-V0	-	○	
280	290	1,9		PTFE 19YF	BRT2	GN0683-A0	-	○	
	295	2,75		PTFE 19YF	BRT2	GN0684-A0	-	○	
	300	4		PTFE 19YF	BRT2	GN5459-V0	-	○	
	305	4		PA 80NP	BRN2	GN9208-00	-	○	
	305	4		PTFE 19YF	BRT2	GN4410-V0	-	○	
285	300	2,75		PTFE 19YF	BRT2	GN0686-A0	-	○	
290	300	1,9		PTFE 19YF	BRT2	GN0687-A0	-	○	
	305	2,75		PTFE 19YF	BRT2	GN0688-A0	-	○	
	315	4		PA 80NP	BRN2	GN9210-00	-	○	
	315	4		PTFE 19YF	BRT2	GN4854-V0	-	○	
295	310	2,75		PTFE 19YF	BRT2	GN0690-A0	-	○	
	315	4		PTFE 19YF	BRT2	GN5738-V0	-	○	
300	310	1,9		PTFE 19YF	BRT2	GN0691-A0	-	○	
	315	2,75		PTFE 19YF	BRT2	GN0692-A0	-	○	
	320	4		PTFE 19YF	BRT2	GN5581-V0	-	○	
	325	4		PTFE 19YF	BRT2	GN4855-V0	-	○	
	332	4		PA 80NP	BRN2	GN9212-00	-	○	

d [mm]	D [mm]	H [mm]	L [mm]	Material	Design	Part No.	PU ¹⁾	US	EU
315	330	2,75		PTFE 19YF	BRT2	GN0694-A0	-	○	
320	335	2,75		PTFE 19YF	BRT2	GN0696-A0	-	○	
335	350	2,75		PTFE 19YF	BRT2	GN0698-A0	-	○	
340	355	2,75		PTFE 19YF	BRT2	GN0699-A0	-	○	
355	370	2,75		PTFE 19YF	BRT2	GN0701-A0	-	○	
360	375	2,75		PTFE 19YF	BRT2	GN0703-A0	-	○	
375	390	2,75		PTFE 19YF	BRT2	GN0705-A0	-	○	
385	400	2,75		PTFE 19YF	BRT2	GN0707-A0	-	○	
400	415	2,75		PTFE 19YF	BRT2	GN0709-A0	-	○	

O-RING | O-RING | PIERŚCIEŃ USZCZELNIAJĄCY TYPU O-RING КОЛЬЦО КРУГЛОГО СЕЧЕНИЯ

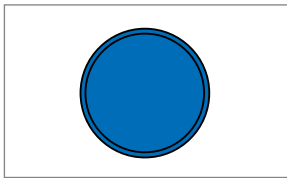

Endlose Runddichtringe mit Kreisquerschnitt
 Dairesel kesitli conta yuvarlak conta halkaları
 Pierścienie uszczelniające o przekroju okrągłym

Бесконечные уплотнения с круглым сечением

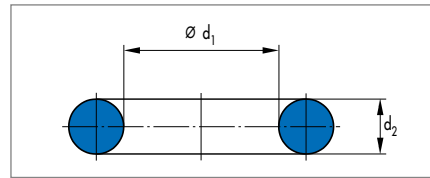

Design DIN 3771-Teil 1, Qualität „N“
 Tasarım DIN 3771-Kısım 1, Kalite „N“
 Wzór DIN 3771-Część 1, jakość „N“

Дизайн DIN 3771-часть 1, качество «N»

Style	Compound	Description	Shore	Colour	Temperature
O-Ring	72 NBR 872	Acrylonitrile butadiene rubber	72	black	-20°C.... +100°C
	88 NBR 156	Acrylonitrile butadiene rubber	88	black	-20°C.... +100°C
	80 FKM 610	Fluoro elastomer	80	brown	-20°C.... +200°C
	70 EPDM 281	Ethylene propylene diene rubber	70	black	-40°C.... +150°C
	70 FFKM 495	Perfluoro Elastomer Simriz	70	black	-15°C.... +230°C
	70 NBR 33002	Acrylonitrile butadiene rubber	70	black	-20°C.... +100°C
	90 NBR 33004	Acrylonitrile butadiene rubber	90	black	-20°C.... +100°C
	80 FKM 33034	Fluoro elastomer	80	black	-20°C.... +200°C
	70 EPDM 33022	Ethylene propylene diene rubber	70	black	-40°C.... +150°C
	70 VMQ 33042	Vinyl-methyl polysiloxane	70	red	-60°C.... +225°C

Werkstoff-Datenblätter zum Herunterladen: www.simrit.com

Malzeme bilgi formlarını sitemizden indirebilirsiniz: www.simrit.com

Specyfikacje tworzyw do pobrania: www.simrit.com

Спецификации материалов для загрузки: www.simrit.com

Standard	Comment
DIN 3770	Wird ersetzt durch / olarak değiştirilmiştir / Zastąpiona przez / Заменен на 3771
DIN 3771	Wird zukünftig ersetzt durch / olarak değiştirilecektir / Zostanie w przyszłości zastąpiona przez / заменить в будущем 3601
ISO 3601	
BS 1806	
R Nr.	
AS 568	Ähnlich zu / 'e benzer / Średnice przekroju podobnie jak / Похожа на ISO 3601 oder / veya / lub / или DIN 3771
JIS B 2401	
BS 4518	
SMS 1586	Entspricht hauptsächlich / Genellikle 'e benzer / w dużym stopniu / Соответствует основному BS 1806
NFT47	Vergleichbar mit / 'e benzer / w dużym stopniu porównywalna z / Сопоставимые с ISO 3601

Bitte beachten Sie unsere allgemeinen Konstruktionshinweise im → Technischen Handbuch

Lütfen, Teknik El Kitapçığımızda yer alan genel tasarım bilgilerinizi dikkate alınız.

Należy zwrócić uwagę na nasze ogólne wskazówki konstrukcyjne zawarte → w Instrukcji Technicznej

Общие технические рекомендации см. → Техническое руководство

Teilliste: → Katalog O-Ringe und statische Dichtungen

Parça listesi: → O-Ring'ler ve statik sızdırmazlık elemanları kataloğu

Zestawienie elementów: → Katalog - pierścienie uszczelniające typu o-ring i uszczelki statyczne

Список изделий: → Каталог «Кольца круглого сечения и статические уплотнения»

MATERIALÜBERSICHT | MALZEME GENEL BAKIŞ OPIS MATERIAŁU | МАТЕРИАЛЬНЫЙ ОБЗОР

Material code	Basic Compound	Hardness Shore A	Color	Used for
94 AU 925	Polyurethan	94	Blue	LF300 / NI300 / KI310 / KI320 / AUN1 / AUN100 / NA300 / AUPS / AUAS / AUAS R / AUASOB / PRW1 / PU82 / PU83 / AUNIPSL / NIPSL320 / AUDIP
70 FKM F201	Fluoro Rubber	70	Black	Pre load component
70 NBR A102	Nitrile Rubber	70	Black	Pre load component / CPH
70 NBR A103	Nitrile Rubber	70	Black	Pre load component / CPH
70 NBR A104	Nitrile Rubber	71	Black	Pre load component / CPH
70 NBR A305	Nitrile Rubber	70	Black	Pre load component
70 NBR A505	Nitrile Rubber	70	Black	Pre load component / CPH
70 NBR B209	Nitrile Rubber	70	Black	S8
72 NBR 708	Nitrile Rubber	72	Black	NIPSL / TR200 / KDN / NADUOP / PNEUKO G / TDUOP
75 FKM 181327	Fluoro Rubber	75	Green	NIPSL 210 / PNEUKO M210
75 FKM 230553	Fluoro Rubber	75	Black	Airzet / NAPN
75 FKM 99104	Fluoro Rubber	75	Black	NAP 210
80 AU 20994	Polyurethan	80	Blue-Violet	NAP 310
80 AU 21000	Polyurethan	80	Purple	Pneuko M 310
80 AU 941	Polyurethan	80	White	NAP 300
80 FKM F975	Fluoro Rubber	80	Brown	DKB / DKH
80 NBR 186349	Nitrile Rubber	80	Red-Brown	Airzet / NAPN
80 NBR 4005	Nitrile Rubber	80	Black	NIPSL
80 NBR 878	Nitrile Rubber	80	Black	NI150 / NI250 / NI400 / NA150 / NA250 / NA400 / Simko 320
80 NBR 99079	Nitrile Rubber	80	Black	NAP 210
80 NBR A104	Nitrile Rubber	80	Black	CPH / DKH
80 NBR A795	Nitrile Rubber	80	Black	DKB / DKH
80 NBR A980	Nitrile Rubber	80	Black	DKB / DKH
80 NBR B246	Nitrile Rubber	80	Black	Seal Set 0214 / Seal Set 0216
82 NBR A567	Nitrile Rubber	82	Black	IUH / OUHR / LBH
85 AU 20991	Polyurethan	85	Purple	NIPSL 300 / NPSL 310
85 AU 21030	Polyurethan	85	Violet	D+S 300
85 FKM K664	Fluoro Rubber	85	Black	P6
85 HNBR G928	Hydrogenated nitrile rubber	85	Black	IUH / Pre load component
85 NBR B247	Nitrile Rubber	85	Black	P6 / P8 / P9
88 NBR 101	Nitrile Rubber	88	Black	H / T / AS / ASOB
88 NBR 99035	Nitrile Rubber	88	Black	AS
90 AU 2090	Polyurethan	90	Black	AN
90 AU 2097	Polyurethane	90	Yellow	H
90 AU 924	Polyurethan	90	Blue	AUDIP
90 FKM F357	Fluoro Rubber	90	Black	LBH
90 NBR 109	Nitrile Rubber	90	Black	N1 / N100 / TDUOH / P8 / DIP
90 NBR A505	Nitrile Rubber	90	Black	IUH / OUHR / LBH
92 AU 21100	Polyurethan	92	Yellowish white	LF300 / HDR-2C

Material code	Basic Compound	Hardness Shore A	Color	Used for
92 AU 9250	Polyurethan	92	Natural-White	ROD / D300 / HBY / SYM / PI / SNAP IN / MRW / DMRW
92 AU U593	Polyurethan	92	Green	LBI
93 AU 2093	Polyurethan	93	Black	LSU / D / ANSH / H / DSH
93 AU V167	Polyurethan	93	Red	TM23 / TMP20 / TM21 / TMP21 / T42 / T44
93 AU V168	Polyurethan	93	RED	TMP20 / T18
94 AU 30000	Polyurethan	94	Blue	LF300 / NI300 / T20 / SM / AUAS / AUAS R / PU5 / PRW1 / PU11 / ROD / D300 / HBY / PI / MRW / DMRW
94 AU 925	Polyurethan	94	Blue	LF300 / NI300 / KI310 / KI320 / AUN1 / AUN100 / NA300 / AUPS / AUAS / AUAS R / AUASOB / PRW1 / PU82 / PU83 / AUNIPSL / NIPSL320 / AUDIP
94 AU U641	Polyurethan	94	Blue	HBY / ISI / OUIS / DKBI
94 AU U801	Polyurethan	94	Yellowish white	HBY / IDI / ISI / UNI / CPI / ODI / OSI / OUIS / DKBI / DKI / DSI / DWI / DWIR
95 AU 2501	Polyurethane	95	Black	AN / AN-SH / D / D-SH
95 AU UH05	Polyurethan	95	Purple	HBY
95 AU V142	Polyurethan	95	Dark-Blue	T20 / T22 / T23 / T24 / TM20 / SM / O503 / T18 / TM21 / OMK PU / T19 / PU11 / PU82 / PU83 / SRC
95 AU V149	Polyurethan	95	Dark-Blue	PU5 / PU6
95 AU V157	Polyurethan	95	Green	TM23
98 AU 928	Polyurethan	98	Blue	HDR-2C / Simko 300
BI-FKM	Cotton fabric fluoro rubber		Black	ESV / EKV
BI-NBR	Cotton fabric nitrile rubber		Black	ES / ESV / M17 / M19
BI-NR	Cotton fabric natural rubber		Black	V1000
HGW HG517	Fabric base laminate		Dark-Grey	KB / KBK / SB / SBK
HGW HG600	Fabric base laminate		Dark-Grey	KB / SB
HGW HG650	Resin bonded fabric		Red	KBK / SBK / SB
HT 2022	Hytrel		Black	1750 / 1704 / AN / D / AN SH / D-SH
HT 2023	Hytrel		Orange	1758
HT 2053	Hytrel		Orange	LSU / H
HT 2055	Hytrel / glass		Orange	1704
PA 4112	Polyamide		Black	FRA / FRI
PA 4201	Polyamide		Black	EKF
PA 4601	Polyamide		Transparent-white	PNEUKO G
PA 80NP	Polyamide		Black	BRN2 / BRN3 / Back Up Ring
PTFE 05ZF	PTFE		Brown	RYT
PTFE 10/F56110	PTFE		Black	FOI / FOA
PTFE 15/F52902	PTFE		Anthracite	TFW
PTFE 177023	PTFE 60% Bronze		Grey-Brown	TFMI / TFMA
PTFE 19YF	PTFE		Brown	SPN / SPNO / SPG / SPGO / SPGW / BRT2 / BRT3
PTFE 31BF	PTFE		Black	SPNC / SPGC
PTFE 55YF	PTFE		Brown	HBTS
PTFE B500	PTFE		Brown	KF / SF
PTFE B602	PTFE / bronze		Brown	OMS MR / OMS MR PR / OMS S PR / OMK E / OMK ES / OMK MR / OMK S / L27 / PT1 / PT2
PTFE C104	PTFE		Anthracite	OMS MR PR / OMS S PR
PTFE GM201	PTFE / glass fiber / MOS2		Light-Gray	OMS MR PR / OMS S / OMS S PR / M15 / OMK E / OMK ES / OMK MR / OMK S / M16 / PT1
VN9400	Verlon		Black	2000 / 2001
VN9800	Verlon		Blue	8000 / 8001

The image shows a page with 18 horizontal grey bars, each representing a line of writing. The bars are evenly spaced and extend across most of the page width, leaving a small margin on the left and right sides. This layout is typical for a notebook or a page intended for taking notes.



Europe		📞	📠	@
Austria		+43 (0) 72 42 47 36-10	+43 (0) 72 42 47 36-120	info.at@fst.com
Belarus		+375 (29) 645 10 98	+375 (17) 295 10 98	info.by@fst.com
BeNeLux		+32 2 704 46 20	+32 2 704 46 29	benelux@fst.com
Denmark		+45 44921833	+45 44922520	info.dk@fst.com
France		+33 (0)3 85 29 30 00	+33 (0)3 85 29 30 99	info.fr@fst.com
Germany		+49 (0) 1805 746748	+49 (0) 1803 746748	info.de@fst.com
Great Britain		+44 (0) 1455204444	+44 (0) 1455204455	info.uk@fst.com
Italy		+39 (0) 45 85 17 600	+39 (0) 45 85 17 650	info.it@fst.com
Norway		+46 (0) 8 705 27 00	+46 (0) 8 83 81 63	info.se@fst.com
Poland		+48 (0) 228337716	+48 (0) 22 8335897	info.pl@fst.com
Portugal		+34 93 573 87 08	+34 93 570 49 65	info.es@fst.com
Russia		+7 (495) 380 06 50	+7 (495) 380 06 50	info.ru@fst.com
Spain		+34 93 573 87 08	+34 93 570 49 65	info.es@fst.com
Switzerland		+41 (0) 44 306 44 22	+41 (0) 44 302 70 02	info.ch@fst.com
Sweden		+46 (0) 8 705 27 00	+46 (0) 8 83 81 63	info.se@fst.com
Turkey		+90 (0) 216 593 07 29	+90 (0) 216 593 11 18	info.tr@fst.com
Ukraine		+38 (050) 352-61-83	+38 (044) 236-05-43	info.ua@fst.com

www.fst.com

America		📞	📠	@
Brazil		+55 11 4072 8000	+55 11 4075 4635	information.br@fnst.com
Canada		+1-866-274-6748	+1 (734) 354 5500	information.cn@fnst.com
Mexico		+55 442 1923 222	+52 442 221 6319	information.mx@fnst.com
USA		1-866-274-6748	+1 (734) 354 5500	information.us@fnst.com

www.fnst.com

Asia		📞	📠	@
China		+86 852-2736 2298	+86 852-2736 2733	info.cn@fst.com
India		+91 124 4689600	+91 124 4018668	info.in@fst.com
Japan		+81 45 548 1123	+81 45 545 4759	info.jp@fnst.com
Singapore		+65 (6) 256 32 33	+65 (6) 265 52 42	info.sg@fnst.com

www.fnst.com

DE Alle Angaben in diesem Katalog basieren auf Erfahrung. Sie stellen den aktuellen Stand unserer Kenntnisse dar. Die Dichtwirkung wird jedoch nicht allein durch das Bauteil erbracht. In bestimmten Anwendungen hängt diese Wirkung in der Tat von anderen Parametern ab, wie beispielsweise Einbaulage, Kontaktbereich, angewandter Druck, Betriebstemperatur, abzudichtende Medien, Schmierung, Vibrationseffekte und jeglichem Eindringen von Schmutz. Diese und andere unbekannte Faktoren können in der praktischen Anwendung signifikante Auswirkungen auf die Dichtungen haben.

Vor diesem Hintergrund lassen sich keine allgemeinen Aussagen über die Arbeitsweise der Produkte in diesem Katalog machen. Die in diesem Katalog enthaltenen Informationen stellen nur empfohlene Werte dar. Wir empfehlen daher, spezifische Anwendungen mit unseren Vertriebsingenieuren zu besprechen. Erprobungen hinsichtlich der Zuverlässigkeit sind oft unverzichtbar. Im Rahmen der Produktoptimierung behalten wir uns das Recht vor, ohne vorherige Ankündigung die Produktpalette, Produktionsstätten, Erzeugnisse und deren Herstellungsverfahren sowie die Informationen in diesem Katalog zu ändern.

Alle früheren Ausgaben werden mit der Veröffentlichung dieser Ausgabe des Katalogs ungültig. Die Vervielfältigung des Katalogs in jeglicher Form bedarf der ausdrücklichen schriftlichen Genehmigung von Freudenberg Sealing Technologies GmbH & Co. KG, 69465 Weinheim, Deutschland.

© Freudenberg Sealing Technologies GmbH & Co. KG
Alle Rechte vorbehalten

TR Bu katalogdaki tüm bilgiler deneyimlerimize dayanmaktadır ve en güncel halini yansıtmaktadır. Sızdırmazlık etkisi tek başına ürün tarafından sağlanamaz. Bunun yanında; montaj şekli, temas yüzeyi, uygulanan basınç, çalışma sıcaklığı, akışkan cinsi, yağlama, titreşim ve akışkanın çevresel koşullardan dolayı kirlenmesi ve bunun gibi bilinmeyen parametreler de sızdırmazlık için çok önemli etkenlerdir. Bu bilgilere dayanarak, katalogta yer alan ürünlerin çalışma şartları hakkında genel ifade vermek mümkün değildir.

Bu bilgiler sadece tavsiye edilen değerleri sunmaktadır. Bu nedenle özel uygulamalarınız için teknik departmanımız ile görüşmenizi öneririz. Ürününüzden maksimum verim alınabilmesi için çalışma koşullarına uygunluğunun değerlendirilmesi gereklidir. Ürün geliştirilme durumunda önceden haber vermeksizin ürün gamını, üretim yerini, ürünleri ve bunların üretim yöntemlerini ve katalogdaki bilgileri değiştirme hakkımızı saklı tutuyoruz.

Bu katalogun yayınlanması ile beraber tüm eski baskılar geçerliliğini kaybetmiştir. Bu katalogun her ne şekilde olursa olsun çoğaltılması Freudenberg Sealing Technologies GmbH & Co. KG, 69465 Weinheim, Almanya'nın özel olarak alınmış yazılı iznine tabidir.

© Freudenberg Sealing Technologies GmbH & Co. KG
Tüm hakları saklıdır

PL Wszystkie dane podane w niniejszym katalogu wynikają z doświadczenia. Nie są odzwierciedleniem aktualnego stanu naszej wiedzy. Działanie uszczelniające jest osiągane nie tylko poprzez zastosowanie niniejszego elementu. W określonych zastosowaniach skuteczność zależna jest w rzeczywistości od innych parametrów, takich jak umiejscowienie, obszar styku, zastosowane ciśnienie, temperatura robocza, rodzaj mediów, smarowanie, efekty drgań i wnikanie zabrudzeń. Te i inne nieznanne czynniki mogą w zastosowaniu praktycznym w istotny sposób oddziaływać na uszczelki.

Z tego względu w niniejszym katalogu nie można podawać ogólnych wskazówek dotyczących działania produktów. Informacje zawarte w niniejszym katalogu są jedynie wartościami zalecanymi. W związku z powyższym polecamy omówienie specyficznych zastosowań z naszymi inżynierami ds. dystrybucji. Często nieodzowne jest przeprowadzenie prób potwierdzających niezawodność produktu. W ramach optymalizacji produktu zastrzegamy sobie prawo do zmian asortymentu produktów, miejsc produkcji, wyrobów i ich metod wytwarzania oraz informacji zawartych w niniejszym katalogu bez wcześniejszego poinformowania.

Wszelkie wcześniejsze wydania tracą ważność w momencie opublikowania niniejszej wersji katalogu. Powielanie katalogu w jakiegokolwiek formie wymaga jednoznacznej, pisemnej zgody firmy Freudenberg Sealing Technologies GmbH & Co. KG, 69465 Weinheim, Niemcy.

© Freudenberg Sealing Technologies GmbH & Co. KG
Wszystkie prawa zastrzeżone.

RU Все сведения, приведенные в настоящем каталоге, основаны на нашем опыте. Они отражают текущий уровень наших знаний. При этом следует учитывать, что уплотняющий эффект реализуется не только самим уплотнением. В определенных случаях данный эффект фактически зависит от других параметров, таких как место монтажа уплотнения, рабочее давление и рабочая температура, среда, в которой применяется уплотнение, смазка, влияние вибрации и попадание любых загрязнений. Эти и прочие неизвестные факторы могут на практике оказывать существенное воздействие на уплотнения.

В связи с этим в данном каталоге не могут быть приведены более общие высказывания о применении продуктов. Сведения, приведенные в каталоге, представляют собой лишь рекомендации. В связи с этим, при наличии каких-либо специфических условий эксплуатации, мы рекомендуем Вам проконсультироваться с нашими инженерами по продажам. Испытания на надежность являются, зачастую, необходимой процедурой. В рамках оптимизации продуктов мы оставляем за собой право без предварительного уведомления изменять ассортимент, изделия и методы их изготовления, места производства, а также содержание настоящего каталога. С публикацией данного издания каталога все предыдущие издания каталога теряют силу.

Любое размножение настоящего каталога в какой-либо форме требует однозначного письменного разрешения фирмы Freudenberg Sealing Technologies GmbH & Co. KG, 69465 Weinheim, Deutschland.

© Freudenberg Sealing Technologies GmbH & Co. KG
Все права защищены.

WWW.FST.COM